

The right choice for the ultimate yield!

LS ELECTRIC strives to maximize your profits in gratitude for choosing us as your partner.

Programmable Logic Control

Communication device

XGT Series

User Manual



XGL-DBDT
XGL-DBDF
XGL-DBDH
XEL-BSSRT
XEL-BSSRF
XEL-BSSRH
GEL-TR4C/C1
GEL-DT4C/C1
GEL-D24C
GEL-RY2C
GEL-AV8C
GEL-AC8C
GEL-DV4C
GEL-DC4C



Safety Instructions

- Read this manual carefully before installing, wiring, operating, servicing or inspecting this equipment.
- Keep this manual within easy reach for quick reference.

LSELECTRIC

Before using the product...

In order to use the product safely and effectively, please read this user's manual thoroughly before using the product.

- ▶ The safety instructions are for preventing an accident or risk in advance by using the product safely and correctly. Please be sure to observe the safety instructions.
- ▶ The safety instructions are separated into two parts including “Warning” and “Caution”, and the meaning of each term is as follows.





Warning

This symbol indicates the possibility of serious injury or death if applicable instruction is violated



Caution

This symbol indicates the possibility of slight injury or damage to products if applicable instruction is violated

- ▶ The meaning of symbols shown in the product and the user's manual is as follows.
 -  is a symbol indicating that caution should be taken as there is a possibility of danger.
 -  is a symbol indicating that caution should be taken as there is a possibility of electric shock.
- ▶ After reading this user's manual, store it in a place where it can be accessed at any time by any person who uses the product.

Class A device (Broadcasting communication device for business purpose)

- ▶ **Sellers or users should note that this device has been registered for electromagnetic compatibility for business purpose (Class A). This device is intended for use outside the home.**

Cautions for designing



Warnin

- ▶ **Install a protection circuit on the exterior of the PLC in order to protect the whole control system in case of abnormality in the external power supply or the PLC module.**

Failure to do so may cause a serious safety problem in the entire system due to incorrect output or malfunction of the PLC.

- Install a device that can protect the system from physical damage such as an emergency stop switch, protection circuit, upper/lower limit switch and forward/reserve operation interlock circuit on the exterior of the PLC.
- The PLC CPU is designed to turn off all outputs and stop the operation if it detects a system failure such as a watchdog timer error and module detachment error during the operation. However, if an abnormality in an output device such as relay and TR has occurred so that the CPU cannot detect such failure, the output may be in on status continuously. Therefore, install a separate circuit that can monitor the output status for an output that may cause a serious problem in case of failure.

- ▶ **Do not connect a load higher than the rated load to the output module or short the output circuit.**

There is a risk of fire.

- ▶ **Design the external power supply of the output circuit in a way that see it not be turned on earlier than the power supply to the PLC.**

Failure to do so may cause incorrect output or malfunction.

- ▶ **In case the computer or other external device exchanges data with the PLC or alters the status of the PLC (changing the operation mode, etc.) through the communication, set the interlock for the sequence program in order to protect the system from a communication error.**

Failure to do so may cause incorrect output or malfunction.

Cautions for designing



Caution

- ▶ **Wire the I/O signal or communication line at least 100mm away from the high voltage line or the power line.**

Failure to do so may cause incorrect output or malfunction.

Cautions for installation



Caution

- ▶ **Use the PLC only in the environment specified in the user's manual or the general specifications of the data sheet.**

Failure to do so may cause electric shock, fire, product malfunction or deterioration.

- ▶ **Before installing the module, be sure to check that the power supply to the PLC is turned off.**

Failure to do so may cause electric shock or product damage.

- ▶ **Be sure to check if each module of the PLC has been fastened correctly.**

If the product is installed loosely or incorrectly, it may cause malfunction, failure or falling.

- ▶ **Check that the I/O or extension connector has been secured correctly.**

Failure to do so may cause incorrect input or output.

- ▶ **Do not expose the PLC to vibration directly in the case of installation environments which experience frequent vibrations.**

Failure to do so may cause electric shock, fire or malfunction.

- ▶ **Prevent any metallic foreign material from entering the product, PLC or modules.**

Failure to do so may cause electric shock, fire or malfunction.

Cautions for wiring

Warning

- ▶ **Before wiring, be sure to check that the power supply to the PLC and external power supplies are turned off.**

Failure to do so may cause electric shock or product damage.

- ▶ **Check if all terminal covers are closed correctly before supplying power to the PLC system.**

Failure to do so may cause an electric shock.

Caution

- ▶ **Check the rated voltage and the arrangement of terminals of each product and wire correctly.**

Doing so may cause fire, electric shock or malfunction.

- ▶ **Fasten the terminal screw tightly with the designated torque.**

Loosely fastening the terminal screw may cause short circuit, fire or malfunction.

- ▶ **Be sure to use class 3 grounding for the PE terminal.**

Improper grounding may cause malfunction.

- ▶ **Prevent foreign materials such as wiring waste from entering the module during wiring.**

Failure to do so may cause fire, product damage or malfunction.

Caution for trial operation and repair

Warning

- ▶ **Do not touch the terminal while power is being supplied.**
Doing so may cause electric shock or malfunction.
- ▶ **Clean or fasten the terminal after turning off the PLC and all external power supplies.**
Failure to do so may cause electric shock or malfunction.
- ▶ **Do not charge, dismantle, heat up, short, or solder the battery.**
Doing so may cause injury or fire due to heating, blowout or ignition.

Caution

- ▶ **Do not separate the PCB from the module case or modify the product.**
Doing so may cause fire, electric shock or malfunction.
- ▶ **Install or separate the module after turning off the PLC and all external power supplies.**
Failure to do so may cause electric shock or malfunction.
- ▶ **Use a two-way radio or cellphone 30 cm away from the PLC.**
Failure to do so may cause malfunction.

Cautions for disposal



Caution

- ▶ **The product or the battery should be disposed of as industrial waste.**
Such waste may discharge toxic materials or explode.

Revision History

Version	Date	Major modification contents	Page
V 1.0	2020.02	Published the first edition	-
V1.1	2020.05	Format and contents modification according to the change of company name (LSIS → LS ELECTRIC)	-
V1.2	2020.11	1. GEL-TR4C, GEL-DT4C contents added 2. Parameter description added	- CH3
V1.3	2022.10	1. DLR topology added 2. Minimum distance specification between nodes added	CH2

Thank you for purchasing PLC of LS ELECTRIC Co., Ltd.

Before use, make sure to carefully read and understand the User's Manual about the functions, performances, installation and programming of the product you purchased in order for correct use and importantly, let the end user and maintenance administrator to be provided with the User's Manual.

The User's Manual describes the product. If necessary, you may refer to the following description and order accordingly. In addition, you may connect our website (<http://www.ls-electric.com/>) and download the information as a PDF file.

Relevant User's Manuals

Title of user's manual	Contents of user's manual
XG5000 User's Manual(for XGK and XGB)	Describes how to use XG5000 software and online functions such as programming, printing, monitoring and debugging using XGT series products.
XG5000 User's Manual (for XGI and XGR)	This XG5000 software user's manual provides a description of online functions such as programming, printing, monitoring and debugging using the XGI and XGR CPU modules.
XGK/XGB Instructions & Programming user's manual	This manual describes how to use and program the instructions used in XGK series.
XGI/XGR Instructions & Programming user's manual	This user's manual provides a description of how to use commands used in the PLC system where the XGI and XGR CPU modules are installed and programming.
XGK-CPU Module user's manual	This manual explains each XGK CPU module, power module, base, I / O module, extension cable specification, system configuration, and EMC standard.
XGI-CPU Module user's manual	This manual explains each XGI CPU module, power module, base, I / O module, extension cable specification, system configuration, and EMC standard.
XGT Ethernet module user's manual	This manual explains the overview of Ethernet module, product specification, installation and commissioning, Smart extension service, high speed link service, server service, EtherNet / IP service, troubleshooting.
XBC Standard/Economic type main unit user's manual	XGB main unit user's manual that describes power, I / O, expansion standard and system configuration, built-in high speed counter standard of XGB economy type and standard type main unit.
XBC Standard/Economic type main unit user's manual (IEC language)	XGB main unit user's manual that describes power, I / O, expansion standard and system configuration, built-in high speed counter standard of XGB economy type and standard type main unit.
XGB Analog user's manual	The XGB Analog user's manual it describes how to use the analog input expansion of the PLC, output, temperature input, standard system configuration and temperature control modules, and how to use them.

© Contents ©

Chapter 1 Overview 1-1

1.1 Guide to use this manual 1-1

1.2 Features 1-2

1.3 Product configuration 1-3

1.3.1 Communication device product configuration 1-3

1.3.2 Mountable I / O module 1-3

1.4 Supported Software 1-6

1.4.1 Software checklist 1-6

Chapter 2 Product specifications 2-1

2.1 General specifications 2-1

2.2 Performance specification 2-2

2.2.1 Extension driver 2-2

2.2.2 Smart I/O expansion 2-6

2.2.3 Smart I/O block 2-7

2.3 Power specification 2-14

2.3.1 Communication device power specification 2-14

2.4 Name of each part and function 2-16

2.4.1 Extension driver 2-16

2.4.2 Smart I/O expansion 2-18

2.4.3 Smart I/O block 2-20

2.5 Specification of cable 2-22

2.5.1 Twisted pair cable 2-22

2.5.2 Optical Fiber Cable 2-23

Chapter 3 Installation and trial operation 3-1

3.1 Installation 3-1

3.1.1 Preparation for operating 3-1

3.1.2 Setting sequence for operation 3-1

3.1.3 Cables Wiring Precautions 3-2

3.2 Test operation 3-4

3.2.1 Precautions for System Configuration 3-4

3.2.2 Sequence of trial operation 3-4

3.2.3 Cautions for network configuration 3-4

3.3 Cautions when connecting to a network 3-5

3.3.1 Using Ring Network 3-5

3.3.2 Using Line Network 3-6

3.4 XG5000 Program 3-7

3.4.1 Project create 3-7

3.4.2 Communication device connection 3-8

3.4.3 I/O synchronous 3-9

3.4.4 Basic parameter setting 3-10

3.4.5 I/O Parameter Setting 3-15

3.5 Station Number, IP address Setting 3-17

3.5.1 Method by station number switch 3-17

3.5.2 XG5000 parameter setting (Static IP) 3-18

3.5.3	Setting by BOOTP.....	3-18
3.5.4	Setting by DHCP.....	3-20
3.5.5	Assigning station number when IP setting by BOOTP, DHCP.....	3-21
3.6	System diagnosis.....	3-22
3.6.1	Running the Diagnostics.....	3-22
3.6.2	Types of diagnostic functions.....	3-23
Chapter 4	Smart Extension Service	4-1
4.1	Overview	4-1
4.1.1	Communication device product configuration.....	4-1
4.1.2	Performance metrics by protocol.....	4-1
4.2	Smart Extension Service Setting	4-2
4.2.1	Communication device station number, IP setting	4-2
4.2.2	Adding Communication device.....	4-2
4.2.3	Communication device setting.....	4-4
4.3	Smart Extension Diagnosis Function.....	4-8
4.3.1	Status by service (Smart extension).....	4-8
4.3.2	View Communication Module Log	4-10
4.4	Smart Extension Service Operation	4-13
4.4.1	System configuration.....	4-13
4.4.2	Sets Communication device (Slaves)	4-14
4.4.3	Ethernet (Master) Setting	4-14
4.5	Smart Extension System Configuration.....	4-18
4.5.1	Typical Configuration.....	4-18
4.5.2	Auto Speed Sync operation.....	4-20
Chapter 5	Server function.....	5-1
5.1	Overview	5-1
5.1.1	Assignment data by module	5-1
5.1.2	Data Allocation Example.....	5-4
5.2	RAPIEnet Server function	5-16
5.2.1	Overview.....	5-16
5.2.2	Data display type	5-16
5.2.3	Diagnosis data display type	5-17
5.2.4	Server operation	5-18
5.2.5	Check service operation.....	5-24
5.3	EtherNet /IP server functions	5-26
5.3.1	Overview	5-26
5.3.2	Data display type	5-29
5.3.3	Server operation	5-31
5.4	Modbus/TCP server function	5-38
5.4.1	Overview	5-38
5.4.2	Modbus/ TCP communication parameter setting.....	5-38
5.4.3	Service operation.....	5-40
5.5	Ethernet System Configuration	5-46
5.6	Modbus/ TCP protocol configuration	5-47
5.6.1	Modbus/TCP operation.....	5-47
5.6.2	Modbus TCP function code list and frame structure	5-49
5.7	Ethernet System Configuration	5-55

Chapter 6	Troubleshooting.....	6-1
6.1	Confirmation by LED of Communication Module	6-1
6.1.1	Abnormal operation display of Expansion driver	6-1
6.1.2	Abnormal operation display of Smart I/O expansion	6-2
6.1.3	Abnormal operation display of Smart I / O block.....	6-2
6.2	Module Error by XG5000	6-3
6.2.1	Error check in XG5000.....	6-3
6.3	Troubleshooting by Error.....	6-4
6.3.1	Troubleshooting.....	6-4
Chapter 7	EMC Standard.....	7-1
7.1	The Requirements for Compliance with EMC Standards	7-1
7.1.1	EMC Standard.....	7-1
7.1.2	Panel.....	7-2
7.2	Requirement to Conform the Low-voltage Directive.....	7-4
7.2.1	Standards applicable to Communication device	7-4
7.2.2	Selection of Communication device	7-4
Appendix.....		A-1
A.1	Describes of terms.....	A-1
A.2	List of flags.....	A-7
A.2.1	Special Relay(F) List	A-7
A.3	Special module U Device/Refresh data list	A-9
A.3.1	Extension Drive mounting module	A-9
A.3.2	Smart I/O expansion Mounting Module	A-90
A.3.3	Smart I/O block.....	A-123
A.4	LED Status Information	A-131
A.4.1	Extension driver	A-131
A.4.2	Smart I/O expansion	A-131
A.4.3	Smart I/O block.....	A-131
A.5	ASCII Code Table.....	A-132
A.6	Ethernet technology compare table.....	A-135
A.7	External dimension (mm)	A-136

Chapter 1 Overview

1.1 Guide to use this manual

This User's manual contains information on specifications, handling, wiring, and how to use the functions required for using this product. It is recommended that you fully understand the performance and functions of the product before applying it to the system.

Classification	Item	Content
Chapter 1	Overview	Describes the configuration of this manual, product features, Communication device product configuration, module types that can be installed, XG5000, and available versions of related products.
Chapter 2	Product specifications	It describes the general specifications, performance specifications, power specifications and cable specifications for PLC. Also, it describes part names and functions.
Chapter 3	Installation and trial operation	Describes the installation procedure, setting sequence for operation, precautions for cable wiring, trial operation, and how to set expansion module in XG5000.
Chapter 4	Smart extension service	Describes the function overview, configuration of Communication device, configuration of Communication device, setting of IP address, Smart extension diagnosis function, Smart extension service operation example, and Expansion system configuration.
Chapter 5	Server function	Outline of RAPIenet server function, server operation, overview of Ethernet/IP server function, server operation, overview of Modbus/TCP server function, operation and configuration of Ethernet system.
Chapter 6	Troubleshooting	Describes LED error check, module error check using XG5000, problem-specific troubleshooting, and communication error code.
Chapter 7	EMC Standard	Describes the requirements for compliance with EMC standards and the requirements for compliance with the Low Voltage Directive.
Appendix	-	It describes of terms, list of flags, LED status, ASCII code table, Ethernet technology compare table, external dimension.

1.2 Features

Communication device have the following features.

- (1) Provides RAPIEnet, EtherNet/IP, Modbus/TCP protocol.

Provides RAPIEnet, EtherNet/IP, Modbus/TCP communication service with Ethernet setting only.

- (2) Various system configuration

Through two Ethernet ports to provide a switching function enabled the line (daisy chain) and ring configurations. Also, various systems can be configured utilizing products that support electrical, optical, and mixed ports.

- (3) Automatic identification of cable type and communication speed

Auto-MDIX and Auto Negotiation provide cross-cable / direct cable and network speed automatic identification and communication services.

- (4) Support XG5000 setting function

Setting parameters of the product through USB or Ethernet port on XG5000.

- (5) XGK/XGB expansion module compatibility

Extension driver can use power, input / output and special module of XGK.
Smart I/O expansion can use power, input / output and special module of XGB.

1.3 Product configuration

1.3.1 Communication device product configuration

The table below shows the configuration of Communication devices.

Type	Content	Note	
Expansion driver	XGL-DBDT	100BASE-TX/1000BASE-T	Category -5E or higher(STP)
	XGL-DBDF	100BASE-FX/1000BASE-X	Fiber Optic(LC)
	XGL-DBDH	100BASE-TX/1000BASE-T 100BASE-FX/1000BASE-X	Category -5E or higher(STP) Fiber Optic(LC)
Smart I/O expansion	XEL-BSSRT	100BASE-TX/1000BASE-T	Category -5E or higher(STP)
	XEL-BSSRF	100BASE-FX/1000BASE-X	Fiber Optic(LC)
	XEL-BSSRH	100BASE-TX/1000BASE-T 100BASE-FX/1000BASE-X	Category -5E or higher(STP) /Fiber Optic(LC)
Smart I/O block	GEL-TR4C/C1	100BASE-TX	Category -5 or higher(STP)
	GEL-DT4C/C1		
	GEL-D24C		
	GEL-RY2C		
	GEL-AV8C		
	GEL-AC8C		
	GEL-DV4C		
GEL-DC4C			

Notes

- (1) Twisted pair cable unit (category 5 or higher) uses 100Mbps switch and can be mixed with existing 10Mbps (category 3 or less), but the network speed is limited to 10Mbps. Please be careful when installing the system.
- (2) When using RAPIenet protocol in Smart extension service, it does not support 10Mbps and when using EtherNet / IP protocol, it supports 10Mbps.

1.3.2 Mountable I / O module

Communication device can use input / output and special module of XGK and XGB.

- (1) Number of I / O modules that can be installed

Type	Maximum mountable I / O module	Note	
Extension driver	Max. 12 modules	The expansion driver is installed in the main base CPU position. Communication module cannot be installed	
			XGL-DBDT
			XGL-DBDF
Smart I/O Expansion	Max. 8 modules	Communication module cannot be installed	
			XGL-DBDH
			XEL-BSSRT
Smart I/O block	I/O module cannot be installed	-	
			XEL-BSSRF
			XEL-BSSRH
			GEL-TR4C/C1
			GEL-DT4C/C1
			GEL-D24C
			GEL-RY2C
GEL-AV8C			
GEL-AC8C			
GEL-DV4C			
GEL-DC4C			

(2) Mountable I / O module list

Large category		Small category	Device Name	Current consumption(mA)
Expansion driver	Digital module	Digital input module	XGI-D21A	20
			XGI-D22A/B	30
			XGI-D24A/B	50
			XGI-D28A/B	60
			XGI-A12A	30
			XGI-A21A/C	20
			XGI-D21D	20
		Digital output module	XGQ-RY1A	260
			XGQ-RY2A/B	500
			XGQ-TR1C	100
			XGQ-TR2A/B	70
			XGQ-TR4A/B	130
			XGQ-TR8A/B	230
			XGQ-SS2A	300
		XGQ-RY1D	260	
		Digital Input/output module	XGH-DT4A	110
		Special module	Analog input module	XGF-AV8A
	XGF-AC8A			420
	XGF-AD4S			610
	XGF-AD8A			420
	XGF-AD16A			330
	XGF-AC4H			340
	XGF-AW4S			180
	Analog output module		XGF-DV4A	190
			XGF-DV8A	190
			XGF-DC4A	190
			XGF-DC8A	190
			XGF-DV4S	200
			XGF-DC4S	200
			XGF-DC4H	200
	Analog input/output module		XGF-AH6A	770
	High Speed Counter module		XGF-HO2A	270
		XGF-HD2A	330	
XGF-HO8A		270		

Large category		Small category	Device Name	Current consumption(mA)
Expansion driver	Special module	Temperature input module	XGF-RD4A	450
			XGF-RD4S	780
			XGF-TC4S	610
			XGF-RD8A	780
		Process control module	XGF-TC4UD	900
			XGF-TC4RT	310
Smart I/O expansion	Digital module	Digital input module	XBE-DC08A	20
			XBE-DC16A/B	40
			XBE-DC32A	50
			XBE-AC08A	30
		Digital output module	XBE-TN/TP08A	40
			XBE-TN/TP16A	50
			XBE-TN/TP32A	80
			XBE-RY08A/B	240
			XBE-RY16A	440
		Digital input-output module	XBE-DR16A	250
			XBE-DN32A	60
	Special module	Analog input module	XBF-AD04A	120
			XBF-AD08A	105
			XBF-AD04C	105
		Analog output module	XBF-DV04A	110
			XBF-DC04A	110
			XBF-DC04B	110
			XBF-DV04C	70
			XBF-DC04C	70
		Analog input/output module	XBF-AH04A	120
		RTD input	XBF-RD04A	100
			XBF-RD01A	100
		TC input	XBF-TC04B	100
			XBF-TC04S	100
		load cell	XBF-LD02S	110
		High Speed Counter Module	XBF-HO02A	270
			XBF-HD02A	330

1.4 Supported Software

Describes major programming tools and other authoring software for using the Communication devices.

For more accurate program and communication applications, please prepare and refer to the following contents and apply them to your system.

1.4.1 Software checklist

	Classification	Related product
Extension driver	XGL-DBDT/ XGL-DBDH/ XGL-DBDF	1. XG5000: V4.30 or higher
Smart I/O expansion	XEL-BSSRT/ XEL-BSSRH/ XEL-BSSRF	2. Ethernet(XGL-EFMxB):V8.0 or higher
Smart I/O block	GEL-TR4C/ GEL-TR4C1/ GEL-DT4C/ GEL-DT4C1/ GEL-D24C/ GEL-RY2C/ GEL-AV8C/ GEL-AC8C/ GEL-DV4C/ GEL-DC4C	3. XOL-ES4T, XOL-ES4H: V1.0 XGL-EH5T:V1.0

Notes

(1) The above program can be downloaded from the following website. If you can not use the Internet, visit the nearest distributor and use the installation CD-ROM.

Website address : <http://www.lselectric.co.kr/>

(2) The XG5000 can be connected and set up via USB or Ethernet terminal.

Chapter 2 Product specifications

2.1 General specifications

The general specifications of the Communication device are as follows.

No	Item	Specification	Related specifications			
1	Ambient temperature	0 ~ 55 °C				
2	Storage temperature	-25 ~ +70 °C				
3	Ambient Humidity	5~ 95%RH , (Non-condensing)				
4	Storage humidity	5~ 95%RH , (Non-condensing)				
5	Vibration resistance	In case of occasional vibration			-	IEC61131-2
		Frequency	Acceleration	Amplitude	Times	
		5≤f< 8.4 Hz	-	3.5mm	X, Y, Z Each direction 10 times	
		8.4≤f≤150 Hz	9.8 m/s ² (1G)	-		
		In case of continuous vibration				
		Frequency	Acceleration	Amplitude		
		5≤f< 8.4 Hz	-	1.75mm		
8.4≤f≤150 Hz	4.9m/s ² (0.5G)	-				
6	Shock resistance	<ul style="list-style-type: none"> • Peak impact acceleration: 147 m/s² (15G) • Duration: 11 ms • Pulse waveform: Half-sine (3 times for each direction of X, Y and Z) 	IEC61131-2			
7	Noise resistance	Square wave impulse noise	AC : ±1,500V DC : ±900V		Internal test standard of LS ELECTRIC	
		Electrostatic discharge	4.0kV (Contact discharge)		IEC61131-2 IEC61000-4-2	
		Radiation field noise	80 ~ 1000MHz, 10V/m		IEC61131-2, IEC61000-4-3	
		Fast transient /Burst noise	Classification	Power module	Digital/analog I/O, communication interface	IEC61131-2 IEC61000-4-4
	Voltage	2kV	1kV			
8	Surrounding environment	Free from corrosive gases and dust				
9	Altitude	Less than 2,000m				
10	Pollution degree	2 or less				
11	Cooling method	Natural air cooling				

Notes

(1) IEC (International Electrotechnical Commission): An international nongovernmental organization which promotes international cooperation in the standardization in the fields of electricity and electronics, publishes international standards and operates relevant conformity assessment systems.

(2) Pollution degree Pollution degree: It is an index indicating the degree of pollution of the service environment that determines the insulation performance of a device, and pollution degree 2 indicates the state in which only non-conductive pollution occurs. However, temporary conduction occurs in this state due to dew formation.

2.2 Performance specification

The following describes the specifications of the system configuration according to the media of the Communication device. Please refer to the table below when configuring the system.

2.2.1 Extension driver

Item		XGL-DBDT	XGL-DBDF	XGL-DBDH
Transmission specifications	Transmission speed	PORT1: 100/1000Mbps PORT2: 100/1000Mbps	PORT1: 100/1000Mbps PORT2: 100/1000Mbps	PORT1(Optical):100/ 1000Mbps PORT2(Electric):100/1000Mbps
	Transmission method	Base band		
	Maximum distance between nodes	100m@CAT5E or higher	2km@100Mbps.MM 550m@1Gbps.MM 5km~80km@ SM	PORT1(Optical): XGL-DBDF same PORT2(Electric): XGL-DBDT same
	Minimum distance between nodes	1m or more ^{Note1)}	-	PORT1(Optical): XGL-DBDF same PORT2(Electric): XGL-DBDT same
	Send media	Electric: Category 5E or higher STP (Shielded Twisted-pair) cable Optical: Multi mode(MMF)/Single mode(SMF) cable		
	Maximum protocol size	1,500Bytes		
	Communication network access method	CSMA/CD		
	Frame error check method	CRC32		
Max. load	Ethernet: 10,000pps, RAPIEnet: 40,000pps			
Topology	When using RAPIEnet : Lines, Ring (using MRS if you use a different topology) When not using RAPIEnet - Line, Tree, Star etc. (with switch) - DLR (Ring node) ^{Note2)}			
Diagnosis function	Station number/IP collision detection function, self-diagnosis service, diagnosis using XG5000			
Station number / IP setting method	Rotary switch, XG5000, BOOTP/DHCP			
Station number / IP setting range	Station number: Rotary switch(1 ~ 99) · When the rotary switch is set to 0, the station number setting value set by the tool (0 to 220) P: 192.168.1.xx(xx:100 + rotary switch 1~99) - When the rotary switch is set to 0, the station number setting value set by the tool			
External connecting terminal	JSB mini B : PADT connection RJ45, SFP : PADT connection, data communication			
Status indication LED	PWR, RUN, SVR, I/F, RELAY, PADT, CHK, ERR, FAULT, LINK, ACT			
Parameter setting	XG5000(USB, Ethernet port)			
Device file	EDS file(Only EtherNet/IP)			
Maximum number of modules to be installed	12ea ^{Note3)}			
I/O Refresh size	Max input refresh size	768 bytes		
	Max output refresh size	768 bytes		
Protocol Specifications	RAPIEnet	Data processing unit	Byte(8bit)	
		Max read data size	1,400 Byte ^{Note4)}	
		Max write data size	1,400 Byte ^{Note4)}	

Item		XGL-DBDT	XGL-DBDF	XGL-DBDH
	EtherNet/IP	Max No. of connected stations per network	64 station	
		Data processing unit	Byte(8bit)	
		Max read data size	Non-periodic tag: 1,400 Byte Non-periodic object : 1,024 Byte Cycle ^{Note5)} 1,024 Byte	
		Max write data size	Non-periodic tag: 1,400 Byte Non-periodic object : 1,024 Byte Cycle ^{Note5)} 1,024 Byte	
		Available communication type	Connection-type (Cycle) messages: Class1 Non connection type(Non-periodic) message: Tag, Object	
		Maximum number of connections	Connection-type (Cycle) :10 Non connection type(Non-periodic) message(Tag, Object):10	
	Modbus/TCP	Data processing unit	Word(16bit),bit	
		Max read data size	125 Word(2,000 Bits)	
		Max write data size	123 Word(1,968 Bits)	
		Maximum number of connections	64	
Current consumption (mA)	100Mbps	560	750	670
	1Gbps	900	740	830

*Note1) When using a cable of less than 1 m, the SNR (Signal to Noise Ratio) decreases due to the influence of reflected waves, which may cause Link Down or packet loss.

*Note2) DLR (Ring node) only works with XGL-DBDT/F/H V1.40 or higher.

*Note3) Use the expansion module within the output current of the power module.

*Note4) It is the size when connecting through its master module XGL-EFMT/H/F(B).

*Note5) The I/O refresh size can only be accessed by an Originator that supports Large forward open (0x5B) if it is greater than or equal to 512 bytes including the header. The input header size consists of a 2-byte PDU sequence number, the output header size includes a 2-byte PDU sequence number and 4 bytes of Run-Idle information. Run-Idle information 4 bytes are determined according to the setting value of EDS.

Notes

(1) I/O Refresh size This size is the same as RAPIenet, EtherNet / IP, Modbus / TCP and refer to the data allocation information of 5.2.2, 5.3.2, 5.4.2.

(2) Max read data size: The size means that can be read at one time. When reading the input refresh area, the first 4 bytes are filled with the LED display information. Refer to Appendix A.3 for LED indication information.

2.2.2 Smart I/O expansion

Item		XEL-BSSRT	XEL-BSSRF	XEL-BSSRH
Transmission specifications	Transmission speed	PORT1: 100/1000Mbps PORT2: 100/1000Mbps	PORT1: 100/1000Mbps PORT2: 100/1000Mbps	PORT1(Electric):100/1000Mbps PORT2(Optical):100/ 1000Mbps
	Transmission method	Base band		
	Maximum distance between nodes	100m@CAT5E or higher	2km@100Mbps.MM 550m@1Gbps.MM 5km~80km@ SM	PORT1(Electric): XEL-BSSRT same PORT2(Optical): XEL-BSSRF same
	Minimum distance between nodes	1m or more ^{Note1)}	-	PORT1(Electric): XEL-BSSRT same PORT2(Optical): XEL-BSSRF same
	Send media	Electric: Category 5E or higher STP (Shielded Twisted-pair) cable Optical: Multi mode(MMF)/Single mode(SMF) cable		
	Maximum protocol size	1,500Bytes		
	Communication network access method	CSMA/CD		
	Frame error check method	CRC32		
Max. load	Ethernet: 10,000pps, RAPIEnet: 40,000pps			
Topology	When using RAPIEnet : Lines, Ring (using MRS if you use a different topology) When not using RAPIEnet - Line, Tree, Star etc. (with switch) - DLR (Ring node) ^{Note2)}			
Diagnosis function	Station number / IP collision detection function, self-diagnosis service, diagnosis using XG5000			
Station number / IP setting method	Rotary switch, XG5000, BOOTP/DHCP			
Station number / IP setting range	Station number: Rotary switch(1 ~ 99) - When the rotary switch is set to 0, the station number setting value set by the tool (0 to 220) P: 192.168.1.xx(xx:100 + rotary switch 1~99) - When the rotary switch is set to 0, the station number setting value set by the tool			
External connecting terminal	JSB mini B : PADT connection RJ45, SFP : PADT connection, data communication 3pin Push in/Screw fixed type connector : power Input			
Status indication LED	RUN, RMS, RNS, RELAY, LINK/ACT1, LINK/ACT2 6 types			
Parameter setting	XG5000(USB, Ethernet)			
Device file	EDS file(Only EtherNet/IP)			
Maximum number of modules to be installed	8ea ^{Note3)}			
Protocol	RAPIEnet, EtherNet/IP, Modbus-TCP, BOOTP, DHCP (RAPIEnet, EtherNet / IP can be Smart extension with XGL-EFMxB)			
I/O Refresh size	Max inputs: refresh size	512 bytes		
	Max output: refresh size	512 bytes		
Protocol Specifications	RAPIEnet	Data processing unit	Byte(8bit)	
		Max read data size	1,400 Byte ^{Note4)}	
		Max write data size	1,400 Byte ^{Note4)}	
		Max No. of connected stations per network	64 station	
	EtherNet/IP	Data processing unit	Byte(8bit)	
		Max read data size	Non-periodic tag: 1,400 Byte Non-periodic object : 1,024 Byte	

			Cycle ^{Note5)} 1,024 Byte
		Max write data size	Non-periodic tag: 1,400 Byte Non-periodic object : 1,024 Byte Cycle ^{Note5)} 1,024 Byte
		Available communication type	Connection-type (Cycle) messages: Class1 Non connection type(Non-periodic) message: Tag, Object
		Maximum number of connections	Connection-type (Cycle) :10 Non connection type(Non-periodic) message(Tag, Object):10
	Modbus/TCP	Data processing unit	Word(16bit),bit
		Max read data size	125 Word(2,000 Bits)
		Max write data size	123 Word(1,968 Bits)
		Maximum number of connections	64

*Note1) When using a cable of less than 1 m, the SNR (Signal to Noise Ratio) decreases due to the influence of reflected waves, which may cause Link Down or packet loss.

*Note2) DLR (Ring node) only works with XEL-BSSRT/F/H V1.80 or higher.

*Note3) Use the expansion module within the output current (3A) of the Smart I/O expansion.

*Note4) It is the size when connecting through its master module XGL-EFMT/H/F(B).

*Note5) The I/O refresh size can only be accessed by an Originator that supports Large forward open (0x5B) if it is greater than or equal to 512 bytes including the header. The input header size consists of a 2-byte PDU sequence number, the output header size includes a 2-byte PDU sequence number and 4 bytes of Run-Idle information. Run-Idle information 4 bytes are determined according to the setting value of EDS.

Notes

(1) I/O refresh size: This size is the same as RAPIenet, EtherNet / IP, Modbus / TCP and refer to the data allocation information of 5.2.2, 5.3.2, 5.4.2.

(2) Maximum read data size: means the size that can be read at one time. When reading the input refresh area, the first 4 bytes are filled with the LED display information. Refer to Appendix A.3 for LED indication information.

2.2.3 Smart I/O block

(1) Communication specifications

Item		Content	
Transmission Specifications	Transmission speed	PORT1/2: 100Mbps	
	Transmission method	Base band	
	Maximum distance between nodes	100m@CAT5E or higher	
	Minimum distance between nodes	1m or more ^{Note1)}	
	Send media	Electric: Category 5E or higher STP (Shielded Twisted-pair) cable	
	Maximum protocol size	1,500Bytes	
	Communication network access method	CSMA/CD	
	Frame error check method	CRC32	
Max. load		Ethernet: 10,000pps, RAPIEnet: 40,000pps	
Topology		When not using RAPIEnet - Line, Tree, Star etc. (with switch) - DLR (Ring node) ^{Note2)}	
Diagnosis function		Station number / IP collision detection function, self-diagnosis service, diagnosis using XG5000	
Station number / IP setting method		Rotary switch, XG5000, BOOTP/DHCP	
Station number / IP setting range		Station number: Rotary switch(1 ~ 99) -When the rotary switch is set to 0, the station number setting value set by the tool (0 to 220) IP: 192.168.1.xx(xx:100 + rotary switch 1~99) -When the rotary switch is set to 0, the station number setting value set by the tool	
Status indication LED		STATUS,PORT1,PORT2, LACTH(output Only)	
Parameter setting		XG5000(Ethernet)	
Device file		EDS file(Only EtherNet/IP)	
Protocol		RAPIEnet, EtherNet/IP, Modbus-TCP, BOOTP, DHCP(RAPIEnet, EtherNet/IP can be Smart extension with XGL-EFMxB)	
I/O Refresh size		Max inputs: refresh size	64 bytes
		Max output: refresh size	64 bytes
Protocol Specifications	RAPIEnet	Data processing unit	Byte(8bit)
		Max read data size	1,400 byte ^{Note3)}
		Max write data size	1,400 byte ^{Note3)}
		Max No. of connected stations per network	64 station
	EtherNet/IP	Data processing unit	Byte(8bit)
		Max read data size	Non-periodic tag: 1,400 Byte Non-periodic object : 1,024 Byte Cycle ^{Note4)} 1,024 Byte
		Max write data size	Non-periodic tag: 1,400 Byte Non-periodic object : 1,024 Byte Cycle ^{Note4)} 1,024 Byte
		Available communication type	Connection-type (Cycle) messages: Class1 Non connection type(Non-periodic) message: Tag, Object
		Maximum number of connections	Connection-type (Cycle) :10 Non connection type(Non-periodic) message(Tag, Object):10
	Modbus/TCP	Data processing unit	Word(16bit),bit
		Max read data size	125 Word(2,000 Bits)

Chapter 2 Product Specifications

		Max write data size	123 Word(1,968 Bits)
		Maximum number of connections	64

*Note1) When using a cable of less than 1 m, the SNR (Signal to Noise Ratio) decreases due to the influence of reflected waves, which may cause Link Down or packet loss.

*Note2) DLR (Ring node) only works with GEL-xxxx V2.40 or higher.

*Note3) It is the size when connecting through its master module XGL-EFMT/H/F(B).

*Note4) The I/O refresh size can only be accessed by an Originator that supports Large Forward Open (0x5B) if it is greater than or equal to 512 bytes including the header. The input header size consists of a 2-byte PDU sequence number, the output header size includes a 2-byte PDU sequence number and 4 bytes of Run-Idle information. Run-Idle information 4 bytes are determined according to the setting value of EDS.

Notes

(1) I/O Refresh size This size is the same as RAPIenet, EtherNet / IP, Modbus / TCP and refer to the data allocation information of 5.2.2, 5.3.2, 5.4.2.

(2) Maximum read data size: means the size that can be read at one time. When reading the input refresh area, the first 4 bytes are filled with the LED display information. Refer to Appendix A.3 for LED indication information.

(2) Digital I/O specifications

1) Digital input(sink/source)

Classification		GEL-D24C	GEL-DT4C1
Input point		32 points	16 points
Rated input current		5mA	
Voltage range		DC 20.4~28.8V(Within 5% ripple ratio)	
ON voltage		DC 19V or higher	
OFF voltage		DC 6V or less	
Response Time	OFF → ON	3ms or less	
	ON → OFF	3ms or less	
Common method		16 points / COM	
Operating indicator		LED ON when input is ON	
External connection method		Terminal block connectors (M3×6 screw)	
Insulation method		Photo coupler insulation	

Circuit configuration

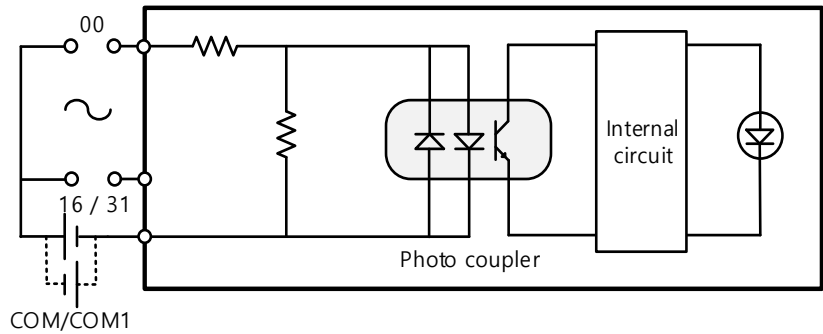

Terminal block configuration

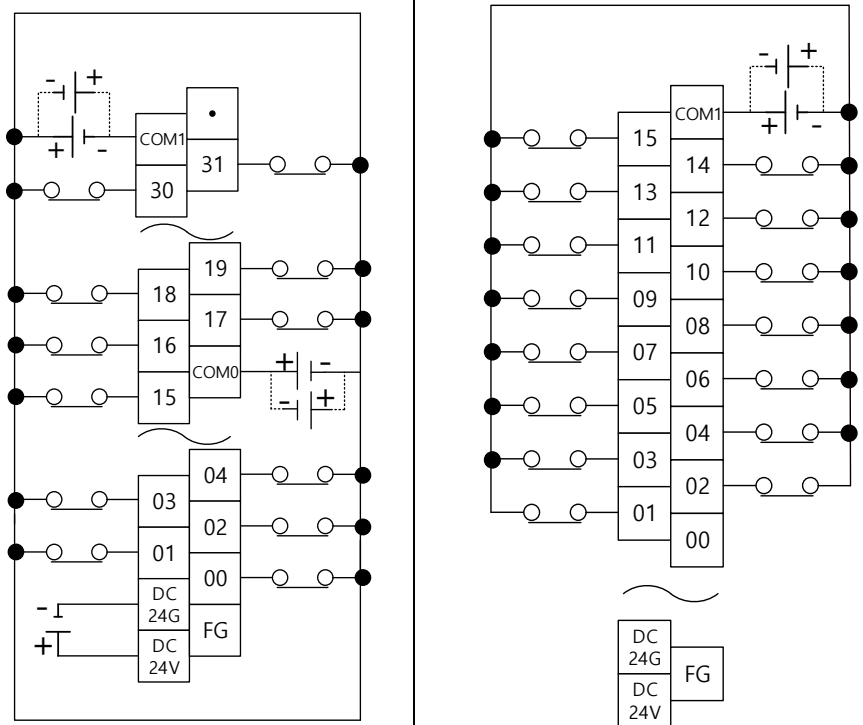

2) Digital output(sink)

Classification		GEL-TR4C1	GEL-DT4C1
Output point		32 points	16 points
Rated load voltage/		DC 24V	
Max. load current		0.5A/point, 3A/COM	
Leakage current at OFF		0.1mA or less	
Max. inrush current		4A 10ms or less	
Max voltage drop at ON		DC 1.5V(0.5A)	
Zener diode Power	Voltage	DC 24V ± 10%(Ripple voltage 4Vp-p or less)	
	Current	30mA (TYP. All point ON)	
Response time	OFF → ON	2ms or less	
	ON → OFF	2ms or less	
Common method		16 points / COM	
Operating indicator		LED ON when input is ON	
External connection method		Terminal block connectors (M3×6 screw)	
Insulation method		Photo coupler insulation	

Circuit diagram

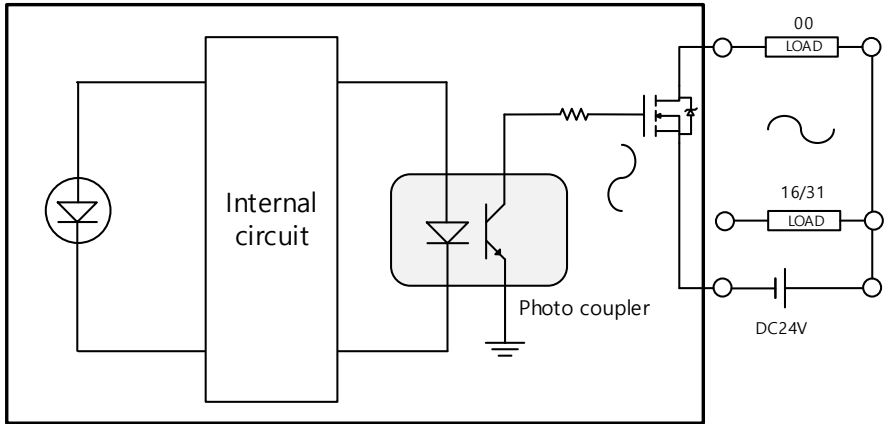

Terminal block configuration

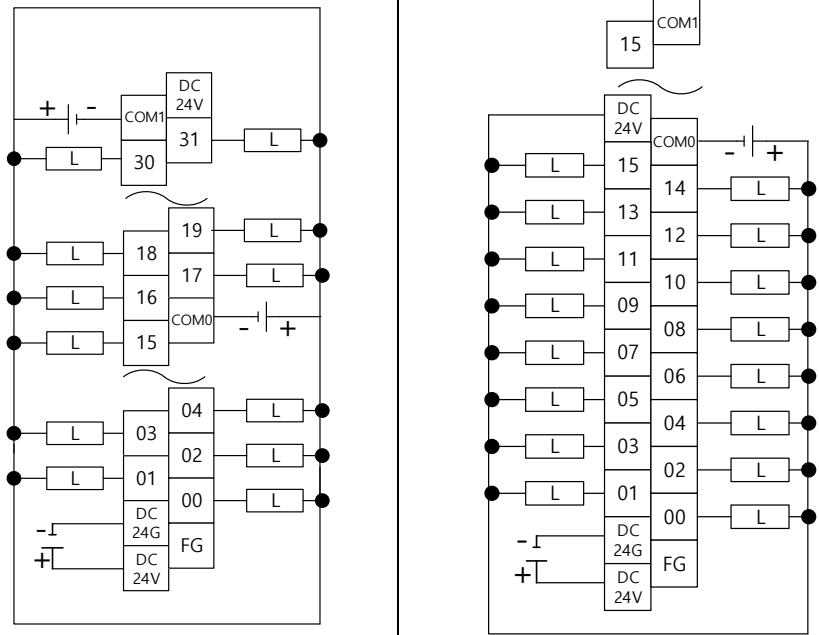

3) Digital output(source)

Classification		GEL-TR4C	GEL-DT4C
Output point		32 points	16 points
Rated load voltage/		DC 24V	
Max. load current		0.5 A/point, 16 point/COM, MAX. 3 A/COM	
Leakage current at OFF		0.1mA or less	
Max. inrush current		4A 10ms or less	
Max voltage drop at ON		DC 1.5V(0.5A)	
Zener diode Power	Voltage	DC 24V ± 10%(Ripple voltage 4Vp-p or less)	
	Current	30mA (TYP. All point ON)	
Response time	OFF → ON	2ms or less	
	ON → OFF	2ms or less	
Common method		16 points / COM	
Operating indicator		LED ON when input is ON	
External connection method		Terminal block connectors (M3×6 screw)	
Insulation method		Photo coupler insulation	
Circuit diagram			
Terminal block configuration			

4) Relay output

Classification		GEL-RY2C
Output point		16 points
Rated switching voltage		DC24V/AC220V, 2A(Cosφ=1)/point 5A/COM
Min. switching load		DC 5V/1mA
Max. switching voltage/frequency		AC 250V DC 110V, 1,200times/hour
Response time	OFF → ON	10ms or less
	ON → OFF	12ms or less
Life span	Mechanical	20 million times or more
	Electrical	Rated switching voltage/current load 100,000 times or more
		AC 200V/1.5A, AC 240V/1A(Cosφ=0.7)100,000 times or more
		AC 200V/1A, AC 240V/0.5A(Cosφ=0.35)100,000 times or more
Common method		8 points / COM
Operating indicator		LED ON when output is ON
External connection method		Terminal block connectors (M3×6 screw)
Circuit diagram		
Terminal block configuration		

5) Analog input

Classification		GEL-AV8C	GEL-AC8C
Input number of channels		8 channels	
Analog input categories		Voltage	Current
Analog input range		DC 1 ~ 5V DC 0 ~ 5V DC 0 ~ 10V DC -10 ~ 10V (Input resistance: 1 MΩ or more)	DC 4 ~ 20 mA DC 0 ~ 20 mA (Input resistance:250Ω) 250Ω)
		Input ranges are set in user program or I/O parameter per each channel	
Digital output Type		16 bit binary value(data 14bit)	
Digital output range	Unsigned value	0 ~ 16,000	
	Signed value	-8,000 ~ 8,000	
	Precise value	1,000 ~ 5,000 (DC 1 ~ 5V) 0 ~ 5,000 (DC 0 ~ 5V) 0 ~ 10,000 (DC 0 ~ 10V) -10,000 ~ 10,000 (DC -10 ~ 10V)	4,000 ~ 20,000 (DC 4 ~ 20 mA) 0 ~ 20,000 (DC 0 ~ 20 mA)
	Percentile Value	0 ~ 10,000	
Max. resolution		1/16,000	
Accuracy		0.3% (ambient air temperature 0 ~ 55°C)	
Max. conversion rate		10ms / 8 channels	
Additional functions		Filter processing(1~99), Count average(2~64,000),Time average (20~16,000)	
Insulation method		insulation between input / output terminal and PLC power (no insulation between channels)	
Output terminal		38 point terminal	
Power supply		External DC24V	
Terminal block configuration	GEL-AV8C		
	GEL-AC8C		

6) Analog output

Classification		GEL-DV4C	GEL-DC4C
Channels		4 channels	
Analog output categories		Voltage	Current
Analog output range		DC 1 ~ 5V DC 0 ~ 5V DC 0 ~ 10V DC -10 ~ 10V (Load resistance: 1 kΩ or more)	DC 4 ~ 20 mA DC 0 ~ 20 mA (Load resistance: 600Ω or less)
		Output ranges is set by I/O parameter for each channel	
Digital input type		16 bit binary value(data 14bit)	
Digital input range	Unsigned value	0 ~ 16,000	
	Signed value	-8,000 ~ 8,000	
	Precise value	1,000 ~ 5,000 (DC 1 ~ 5V) 0 ~ 5,000 (DC 0 ~ 5V) 0 ~ 10,000 (DC 0 ~ 10V) -10,000 ~ 10,000 (DC -10 ~ 10V)	4,000 ~ 20,000 (DC 4 ~ 20 mA) 0 ~ 20,000 (DC 0 ~ 20 mA)
	Percentile Value	0 ~ 10,000	
Max. resolution		1/16,000	
Accuracy		0.3% (ambient air temperature 0 ~ 55°C)	
Max. conversion rate		10ms / 4 channels	
Additional functions		Setting of channel output status(previous, Min, Mid, Max value)	
Insulation method		insulation between input / output terminal and PLC power (no insulation between channels)	
Output terminal		38 point terminal	
Power supply		External DC24V	
Terminal block configuration	GEL-DV4C		
	GEL-DC4C		

2.3 Power specification

2.3.1 Communication device power specification

(1) Extension driver

Refer to the XGK power supply specification.

(2) Smart I/O expansion

Describes power specification of the Smart I/O expansion.

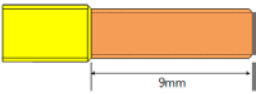
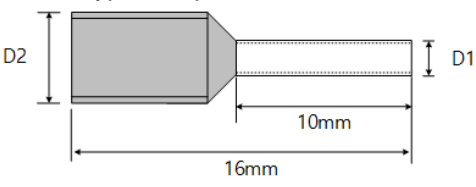
Item		Specifications	Condition
Input	Rated input voltage	DC24V	-
	Input voltage range	DC20.4 ~ 28.8V (-15%, + 20%)	Within -15%, +20% of rated input
	Input current	1.3A or less(Typ.1A)	Input+ DC28.8V, Max. load
	Inrush current	50A peak or less	Input+ DC28.8V, Max. load
	Efficiency	80 % or more	Input+ DC28.8V, Max. load
	Permitted momentary power failure	Less than 10 ms	Input+ DC28.8V, Max. load
Output	Rated output voltage	DC5V (±2%)	-
	Output point	3.0A	-
Power supply status indication		When output voltage is normal LED On	
Wire specification	Using solid wire	Wire specification: 24 ~ 16 AWG (0.2 ~ 1.5mm ²) Strip: 9mm 	
	Using stranded wire	Sleeve type crimp terminal  D1 and D2 according to the wire standard are as follows. - 20 AWG: D1(1mm), D2(2.6mm) - 18 AWG: D1(1.2mm), D2(2.8mm)	

※ It is recommended that you use a power supply with a maximum 4A fuse to protect the power supply.

(3) Smart I/O block

Item	Specification
Input power	DC 24V (Range :DC20.4V ~ 28.8V)
Input current	0.5A(+24VDC)
Inrush current	40A or less(24VDC input)
Power display	LED ON at power input
Applicable cable specifications	1.5 ~ 2.5mm ² (AWG16 ~ 22)
Applicable tightening torque	12kg · cm

Notes

- 1. Allowable momentary power failure time
It is the time to maintain the normal output voltage (normal operation) when the input voltage (DC24V) is below the rated value (DC20.4V).
- 2. Use UL approved power supply.
Use a power supply that meets Class 2 or that meets the Limited voltage limited circuit (LVLC) requirements.

2.4 Name of each part and function

2.4.1 Extension driver

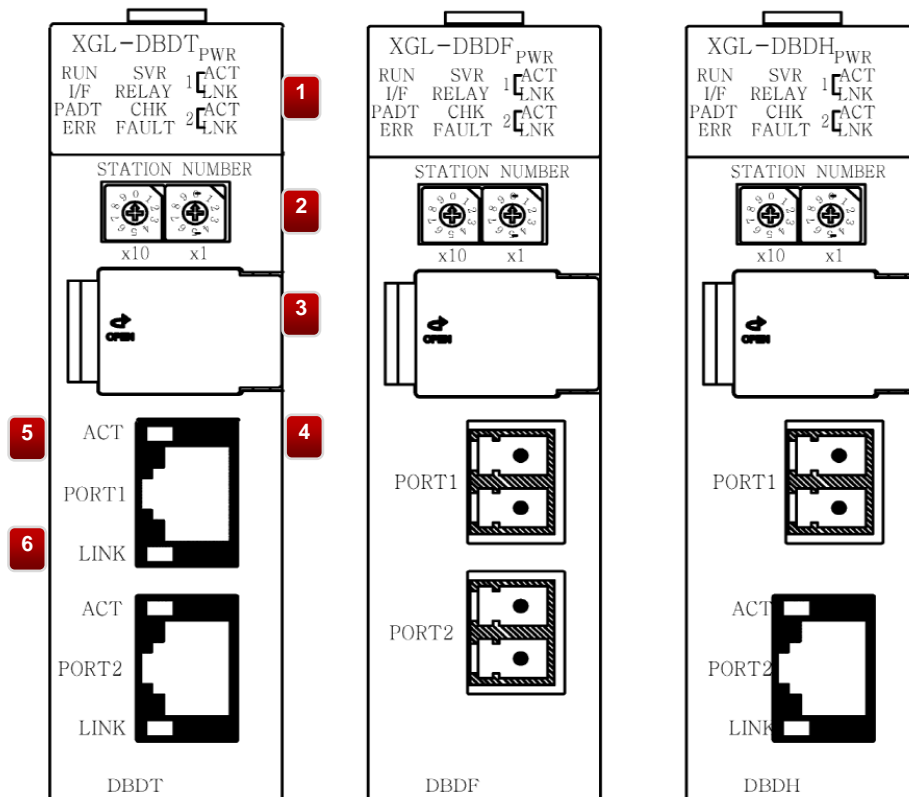

(1) Name of each part

No.	Name	Content
1	LED display	Please see below.
2	Station number switch	The station number of the product can be set from 0 to 99.
3	USB connector	It is a USB connector for connection to set the Expansion Driver.
4	Communication connector	It is a connector for electric cable for connecting Ethernet communication with external device. It is a connector for optical fiber cable for Ethernet communication with external device.
5	RJ-45 ACT (Yellow)	ON: When data is transmit or receive. Flickering: when sending stops repeatable during transmission. Off: Do not sending or receiving data.
6	RJ-45 LNK (Orange & Green)	ON: when the communication network is connected. (Green On:1Gbps, Orange On:100Mbps) Off: The communication network is connected at 10 Mbps, or the network is not connected.

(2) Names of LED and Function

Names of LED	LED display contents	LED status	Functional Description
PWR	Display module power status	ON	Power On state.
		OFF	Power Off state.
RUN	Display module operation status	ON	CPU module is in the run state.
		OFF	CPU module is in the stop state.
		. Flickering	CPU module is in service standby.
I/F	Display Smart extension service operation state.	Flickering	Status of send and receive between Ethernet (Master) module and Extension driver module.
		OFF	There is no send and receive between Ethernet (Master) module and Extension driver module.
PADT	Display Smart extension service operation state.	ON	Operating remote service with remote Ethernet communication device (including PC).
		OFF	Remote service operation is disabled.
ERR	Display module failure state	ON	The module is critical error or detached.
		OFF	Normal operation.
SVR	Display server service operation state.	ON	Connection with Client service with remote Ethernet (including PC).
		OFF	No connection with Client
RELAY	Display relay service operation state.	ON	When the Relay option of the basic parameter is checked and the media speed of Port 1 and Port 2 is the same, the data frame can be relayed.
		Flickering	The Relay option of this parameter is checked and blinks when the communication speed is different.
		OFF	The relay option is not selected.
CHK	Display Check LED operation state	ON	A station conflict other station number on network The CPU is in the WARNING state.
		Flickering	OS or parameters are being written to flash memory.(LED toggle) RAPIenet network change over switching ring→line.
		OFF	Normal operation.
FAULT	Display FAULT LED operation state.	ON	A local station conflict occurred on the network.(Turned off when the station number is released) IP conflict or Flash Erase.(Off after completing Flash Erase)
		Flickering	Communication frame errors (CRC errors and other error handling). Slave is in error when RAPIenet slave is controlling.
		OFF	Normal operation.
ACT	Display ACT LED operation state.	ON	Sending and receiving data.
		Flickering	When sending stops repeatable during transmission.
		OFF	Do not sending or receiving data.
LINK	Display LINK LED operation state	ON	When the communication network is connected.
		OFF	When the communication network is not connected.

Notes

(1) Relay function is not supported at 0Mbps, so if Relay option is checked at 10Mbps, Relay LED will be off.

2.4.2 Smart I/O expansion

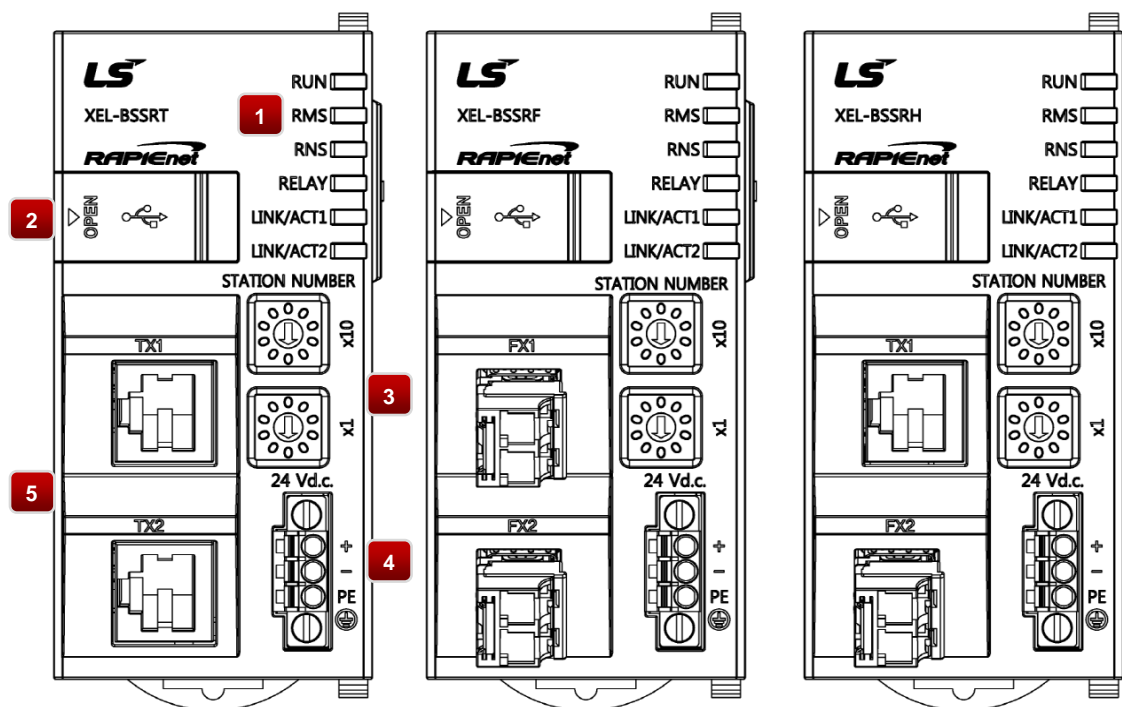

(1) Name of each part

No.	Name	Content
1	LED display	Please see below.
2	USB Connector	It is a USB connector for connection to set the Smart I/O expansion.
3	Station number switch	The station number of the product can be set from 0 to 99.
4	Power input connector	24V DC input power input terminal for module.
5	Communication connector	It is a connector for electric cable for connecting Ethernet communication with external device. It is a connector for optical fiber cable for Ethernet communication with external device.

(2) Names of LED and Function

Names of LED	LED display contents	Color	LED status	Functional Description
RUN	Display module operation status	Red/Green	Green On	Ethernet (Master) run status.
			Red On	Ethernet (Master) stop status.
			Green flicker	This is Initial service wait state or time out. ^{Note1}
			OFF	Power Off state.
RMS	Display module state (Module Status)	Red/Green	Green On	Normal operation.
			Green flicker	The expansion device setting is not completed.
			Red On	An unrecoverable error has occurred.
			Red flicker	There is a recoverable error (misconfiguration, parameter error, initialization error, mismatching port-to-port speed or duplex).
RNS	Display network state (Network Status)	Red /Green	Green On	When data is received normally.
			Green flicker	This is the initial state of the network.
			Red On	A duplicate IP address / station number is detected.
			Red flicker	Timeout, station number conflict, overload status (receiving more than 60000 packets per second) from other nodes on the network.
RELAY <small>Note2</small>	Display relay service operation state.	Red /Green	ON	When the Relay option of the basic parameter is checked and the media speed of Port 1 and Port 2 is the same, the data frame can be relayed.
			OFF	The relay option is not selected.
LINK ACT1	Display LINK/ACT LED operation state.	Yellow/Green	Green On	1G Link=Yes, Activity=No
			Green flicker	1G Link=Yes, Activity=Yes
			Yellow On	10/100M Link=Yes, Activity=No
			Yellow flicker	10/100M Link=Yes, Activity=Yes
			OFF	Link=No, Activity=NA
LINK ACT2	Display LINK/ACT2 LED operation state.	Yellow/Green	Green On	1G Link=Yes, Activity=No
			Green flicker	1G Link=Yes, Activity=Yes
			Yellow On	10/100M Link=Yes, Activity=No
			Yellow flicker	10/100M Link=Yes, Activity=Yes
			OFF	Link=No, Activity=NA

Note1) In case of Smart extension, the data is not received during the watchdog timer of the master, or during the reception timeout setting time of the basic parameter if it is not Smart extension.

Note2) RELAY LED Status display

- a) If RAPIEnet is Enable, it is On according to RAPIEnet status (General Device or RING).
- b) If RAPIEnet is Enable and Line topology, Line manager is On according to basic parameter setting.
- c) If RAPIEnet is Disable, it is On according to basic parameter setting.
- d) If On is described above, both ports should be Link Up and the media speed between the two ports should be the same.

Notes

(1) Use the following standards to operate the station number switch of Expansion driver and Smart I / O expansion.

Tip thickness(W) : 0.5 ~ 0.6mm

Tip width(L) : 2.0 ~ 2.5mm

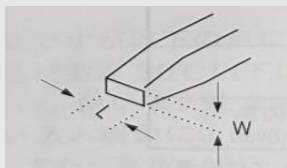

2.4.3 Smart I/O block

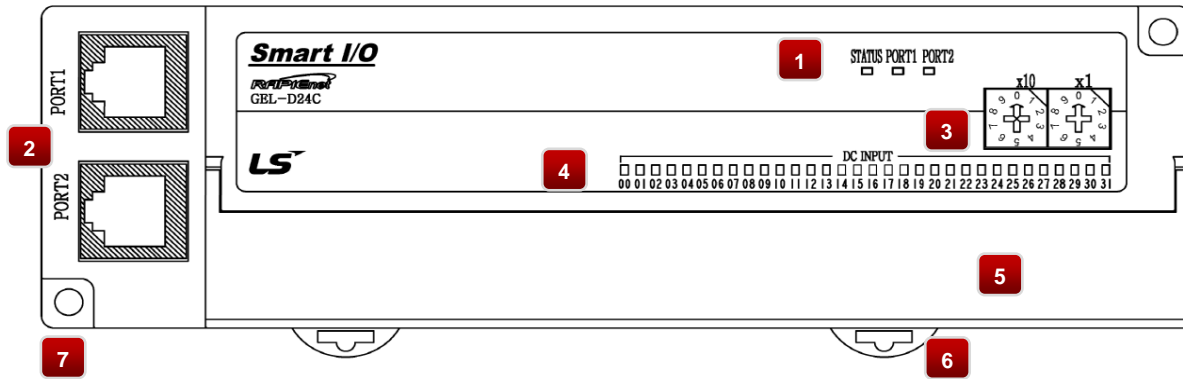

(1) Name of each part

No.	Name	Content
1	LED display	Please see below.
2	Communication connector	It is a connector for electric cable for connecting Ethernet communication with external device.
3	Station number switch	1. It is a switch to set the station number of the own station. 0~63 setting available. - X10 : 10 digits, X1 : 1 digits 2. When setting station no. 90 or more, it operates for special purpose. 1) 90, 91: OS Download mode for the user to arbitrarily prohibit the setting. 2) 92: Self-test mode. 3) 93~99: Communication status LED lighting confirmation mode.
4	Input/output LED	Indicates the contact status of I/O terminal. There is no LED display for analog input / output.
5	Terminal block	It is a terminal block for power supply, input / output and analog wiring.
6	HOOK	Please refer to DIN rail specification with DIN rail mounting hook.
7	Hole for fixation	It is a hole for fixing the product to the panel.

(2) Names of LED and Function

Names of LED	LED display content	Color	LED status	Functional Description
STATUS	Display module state	Green/Red	Green On	Normal operation.
			Green flicker	The parameter is not received.
			Red On	Heartbeat Error, network dropout, and local station number collision.
			Red flicker	Boot mode operation, station number collision between other nodes, parameter setting error, initialization error
PORT1/PORT2	Indicates the communication status of port 1 and 2	Red/Green	Green On	Network communication is connected to Port 1 and 2.
			Green Off	Communication is not connected.
			Red flicker	Port 1 and 2 are in normal communication status.
LATCH	Display output data LATCH	Green	ON	Output data is hold during abnormal communication ^{Note1} .
			OFF	Output data is cleared during abnormal communication.

*Note1) Abnormal communication state: A situation where a network problem prevents receiving data from the master within a certain period of time.

*Note2) LATCH: LATCH function display is applied only to output module (GEL-TR4C/TR4C1/DT4C/DT4C1/RV2C)

Notes

(1) Heartbeat Error occurs when heartbeat usage is enabled on an Communication device (server) in the Ethernet (Master). Communication is made at the time interval set by the server from the master, so that the communication abnormality can be known in advance.

2.5 Specification of cable

2.5.1 Twisted pair cable

Twisted pair cables are classified into two types according to the following standards.

Shield or not: 3 Categories (UTP, FTP, STP), Applied frequency band: 7 Categories (Cat.1~ 7)

(1) Cable type (Shield)

Classification	Detail	Usage
UTP(or U.UTP)	Unshielded high speed signal cable	Up to 200MHz Sound + information (data)+ Low-end video signal
FTP(or S.UTP)	Cable where only the cable core is shielded	Max. 100MHz Electromagnetic interfere (EMI) and electrical stabilization are considered. Sound + information (data) + low grade video signal
STP(or S.STP)	Double shielded cable, Pair individual shielding and cable core are shielded	Up to 500MHz Sound + information (data)+ video signal, Replacement of 75Ω coaxial cable

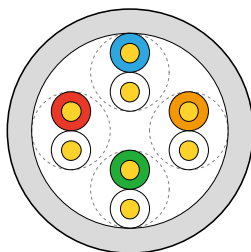

-UTP-

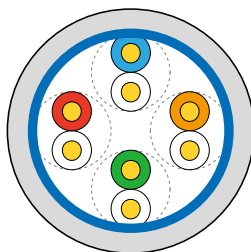

-FTP-

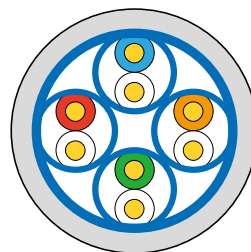

-STP-

Notes

- (1) UTP : Unshielded Twisted Paired Copper Cable
- (2) FTP : (Overall) Foiled Twisted Paired Copper Cable
- (3) STP : (Overall) Shielded(and Shielded Individually Pair)Twisted Paired Copper Cable
- (4) PLC Ethernet communication cable is recommended to use S.STP cable. If the S.STP cable can not be used due to the field conditions, a module error may occur due to communication error and noise.

(2) Cable categories

Classification	Applied frequency (MHz)	Transmission speed (M/Gbps)	Shield or not	Usage
Category 5	100	10/100M	Unshielded	100BASE-TX Support(100m)
Category 5e	100	100M/1G	Unshielded	1000BASE-T support
Category 6	250	1G	Unshielded /Shielded	1000BASE-T support
Category 6a	500	10G	Shielded	10G BASE-T support
Category 7	600	10G	Shielded	10G BASE-T support
Category 7a	1000	10G	Shielded	10G BASE-T support

(3) Example of category 5 twist pair wire (UTP) (CTP-LAN5)

Item	Unit	Value	
Conductor resistance (Max.)	Ω/km	93.5	
Insulation resistance(Min.)	$M\Omega\cdot\text{km}$	2,500	
Withstand voltage	V/minute	AC 500	
Characteristic impedance	$\Omega(1\sim 100\text{MHz})$	100 ± 15	
Attenuation	dB/100m or less	10MHz	6.5
		16MHz	8.2
		20MHz	9.3
Near-end crosstalk attenuation	dB/100m or less	10MHz	47
		16MHz	44
		20MHz	42

2.5.2 Optical Fiber Cable

Item	Value
Cable type	MMF(Twin strands of Multi-mode fiber) /SMF(Single-mode fiber)
Connector	XGL-EFMF: SC connector XGL-EFMFB, XGL- DBDH/F, XEL-BSSRH/F: LC connector

Notes

- (1) The connection cable of the communication module differs according to the system configuration and environment, so please consult with a specialist.
- (2) The characteristics of the optical cable are that when the fingerprint or contaminants are caught on the end of the cable, attenuation may occur and the communication may be interrupted.

Chapter 3 Installation and trial operation

3.1 Installation

3.1.1 Preparation for operating

- (1) Check the basic elements necessary for the system configuration and select a proper communication module.
- (2) Select a cable for the communication module.
- (3) When installing the communication module, make sure that there is no foreign substance in the base connector to be mounted, and check that the connector pin of this module is not damaged.
- (4) Ethernet module can be mounted on the main base and expansion base, but it is recommended to use it on the main base.
- (5) When installing the module, insert the raised part of the lower part of the module into the base groove without connecting the communication cable, and apply enough force until the upper part is completely locked with the base locking device. If it is not locked, there may be abnormality in the interface with the CPU module.
- (6) Cables used for communication module should be installed referring to the standard.
- (7) Ethernet switches and cables required for communication with the Ethernet module should be selected as standard products.

3.1.2 Setting sequence for operation

Describes the order of installation and operation of the product. When the installation of the product is completed, please install and set up the system in the following order.

- (1) Connect the Communication device to the Ethernet network.
- (2) Turn on the system.
- (3) Set basic parameter in XG5000.
- (4) Download the basic parameters and reset the module.
- (5) Check the module status through [module status information] - [system diagnosis] in XG5000.
- (6) Check the response from the PC by performing a PING TEST to the network module.
- (7) After RAPIEnet, EtherNet/IP, Modbus master module setup is completed, operation starts.

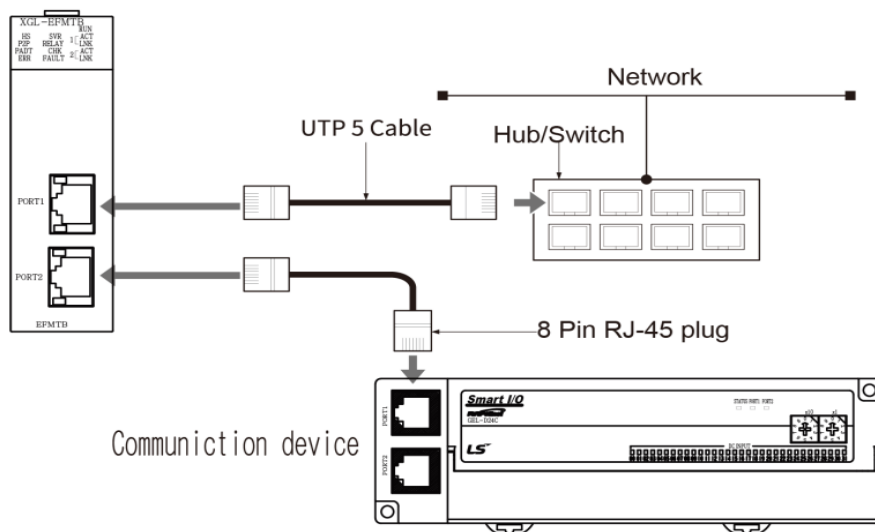

3.1.3 Cables Wiring Precautions

Typically, the hub uses a cross cable made by twisting transmit and receive internally. Communication device supports Auto-MDIX, so it can be used regardless of the cable type.

(1) Type of UTP cable

1) Straight cable

The method to connect the signal lines for the straight cable is as follows.

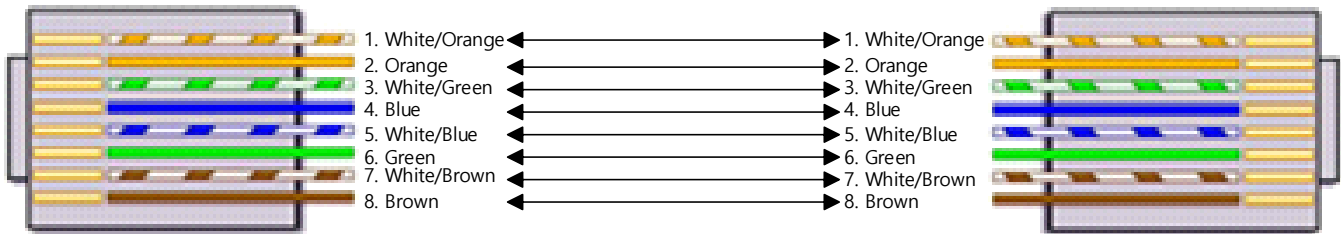

2) Cross cable

The method to connect the signal lines for the cross cable is as follows.

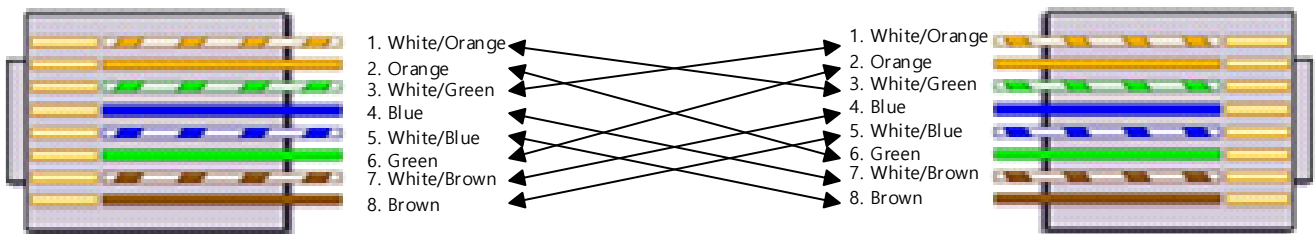

(2) UTP Cable Installation Precautions

- 1) For reliable 1,000Mbps signal transmission using UTP cable, please use cable satisfying category-5E or higher.
- 2) Be careful not to exceed excessively the tensile strength of the cable while wiring. Strip off the sheath to the desired wiring length while being careful not to damage the insulator.
- 3) The wire and patch cord should be wired loosely. If you connect too strongly, the characteristics of Category-5E may be deteriorated.
- 4) When installing the UTP cable, maintain a proper distance between the EMI source and the UTP cable.

Condition	Minimum separation distance		
	2.0KVA or less	2.5 KVA	5.0KVA or higher
Unshielded power line or electrical equipment are open or in close proximity to non-metallic pipes	127mm	305mm	610mm
If the unshielded power line or the electric equipment is close to a buried metallic pipe	64mm	152mm	305mm
If the power line in the buried metallic pipe (or equivalent shielded metallic pipe) is close to a buried metallic pipe	-	76mm	152mm
Transformer, electric motor Fluorescent lamp	1,016mm 305mm		

Notes

(1) When the voltage is 480V and the power rating is 5KVA or more, additional calculation is required.

(3) Precautions for installing the optical fiber cable

For the maximum segment length, refer to the installed SFP (distance between this module and the optical switch).
Cross the module Tx and optical switch Rx, module Rx and optical switch Tx.

Notes

(1) The optical cable is susceptible to impact, pressure, folding, pulling, etc.

The contamination between the optical cable interface at the end of the connector and the connector may cause communication failure.

If you are installing outdoors, you need additional cable protection measures appropriate for your installation environment.

(2) The optical connector of the Communication device uses LC type. Please connect SC-LC converter when communicating with the SC type product.

3.2 Test operation

3.2.1 Precautions for System Configuration

Install the system using the Communication device after checking the following items.

- (1) Select a dedicated cable for the communication module.
- (2) Ensure that the connector pin is not damaged when installing the communication cable.
- (3) Refer to Chapter 2 Product Specifications for the types of available expansion modules and the number of modules that can be installed.
- (4) Mount the module on the relevant slot with the cable not connected. After mounting the module, make sure to lock the module. If it is not locked, there may be abnormality in the interface with the CPU module.

3.2.2 Sequence of trial operation

- (1) Check the connection status of the communication cable.
- (2) Check the power supply and turn on the power.
- (3) Check if the power LED is on.
- (4) Check the LED status of the basic unit.
 - If abnormal, refer to the troubleshooting in the instruction manual of the CPU module.
- (5) Check the status of the LINK LED.
 - If the LINK LED is off while the line is connected to the cable, refer to troubleshooting.
- (6) Set the Ethernet(Master) module correctly and then start the system operation

3.2.3 Cautions for network configuration

- (1) Each device should have a unique IP address. If the IP address is duplicated, normal communication is not available.
- (2) In order to use the RAPIEnet service, set a different station number for each station.
- (3) A communication cable with specified specifications should be used. If a cable which is not specified is used, a communication failure may occur.
- (4) The communication cable should be checked for disconnection or short circuiting before installation.
- (5) The cable should be fixed to the communication cable connector firmly until a click is heard. If the cable is connected incompletely, a communication failure may occur.
- (6) The communication cable should be connected separately from the power line or inductive noise.

3.3 Cautions when connecting to a network

If you connect a node that supports the RAPIEnet protocol and a node that does not support it on the same network, please note the following.

3.3.1 Using Ring Network

When using a ring network, a node supporting the RAPIEnet protocol elects a ring manager for ring control. At this time, because Relay option is disabled, nodes that do not support RAPIEnet protocol connected to Ring Manager cannot communicate with other nodes except Ring Manager. (Relay operation is not performed even if Relay option of Ring Manager is Enable.)

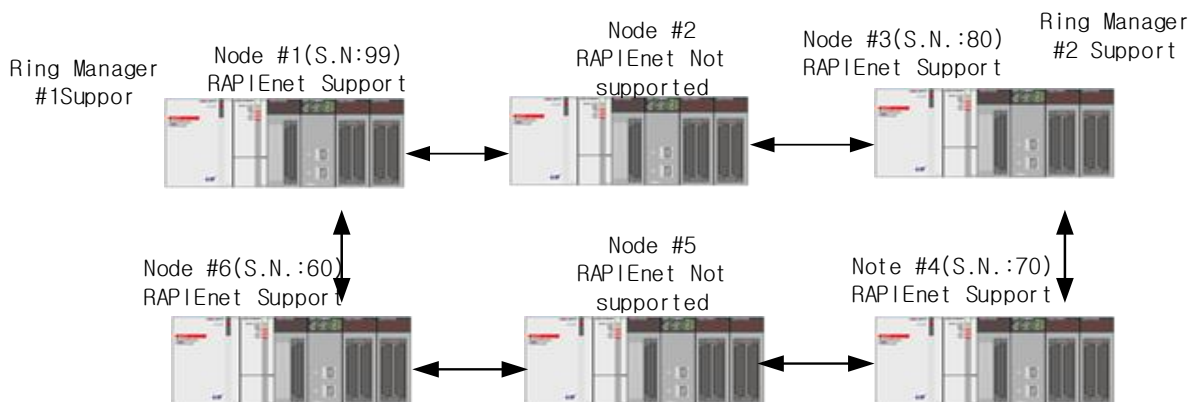

RAPIEnet Unsupported Node	Communication					
	Node #1	Node #2	Node #3	Node #4	Node #5	Node #6
Node #2	impossible	-	impossible	impossible	impossible	impossible
Node #5	possible	impossible	possible	possible	-	possible

Note

When configuring a ring network, the standards for selecting a ring manager are as follows. (See picture above)

- (1) Among the RAPIEnet supporting nodes, the node with the highest station number is selected as Ring Manager # 1.
- (2) Among the neighboring RAPIEnet supporting nodes of the node selected as Ring Manager # 1, the node with the highest station number is selected as Ring Manager # 2.(# 3 which is the highest station number among nodes # 3 and # 6 is selected)
- (3) Ring Manager # 1 and # 2 do not relay function.

3.3.2 Using Line Network

When using a line type network, the last of both nodes that support the RAPIEnet protocol is elected to the Line Manager. . At this time, if you connect nodes that do not support the RAPIEnet protocol to the outside of the line managers, the nodes that can communicate with the nodes are determined by the relay option of the line manager.

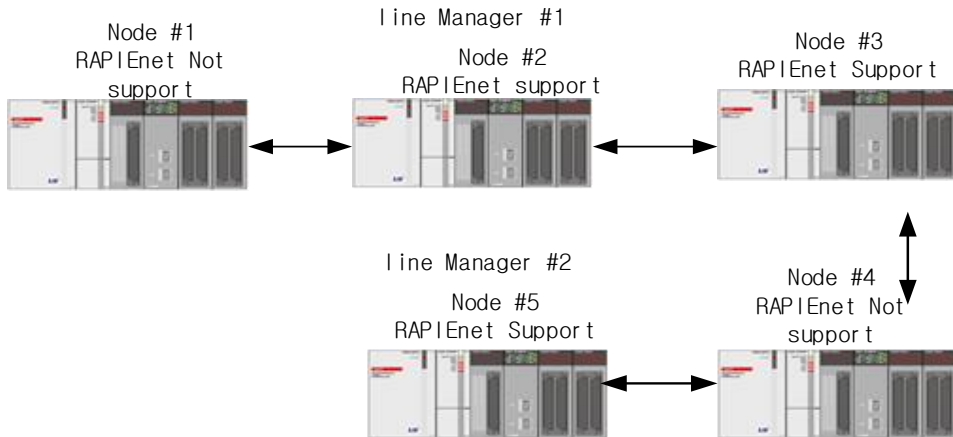

RAPIEnet Unsupported Node	Node #2 Relay option	Communication				
		Node #1	Node #2	Node #3	Node #4	Node #5
Node #1	Enable	-	possible	possible	possible	possible
	Disable	-	possible	impossible	impossible	impossible
Node #4	Enable	possible	possible	possible	-	possible
	Disable	impossible	possible	possible	-	possible

3.4 XG5000 Program

XG5000 can change the basic parameter setting and IO parameter of the Communication devices. XG5000 is a communication setting tool that sets and manages communication parameters, system parameters, service selection, parameter creation and frame information.

Functions related to the communication device module of XG5000 can be classified as below.

- (1) Basic and module parameter settings of the communication system
- (2) Communications diagnostic services

Parameters and files set by the user can be written (downloaded)/read(uploaded) to the Communication device via USB. This chapter focuses on the settings required when using the Communication devices.

3.4.1 Project create

On the XG5000, Select [Project] → [New Project] to create a new project. In the New Project menu, select the project name, CPU series, CPU type. Communication devices are divided into Network Adapter among CPU series. There are 3 types of Extension driver, 3 types of Smart I/O expansion, and 8 types of Smart I/O block.

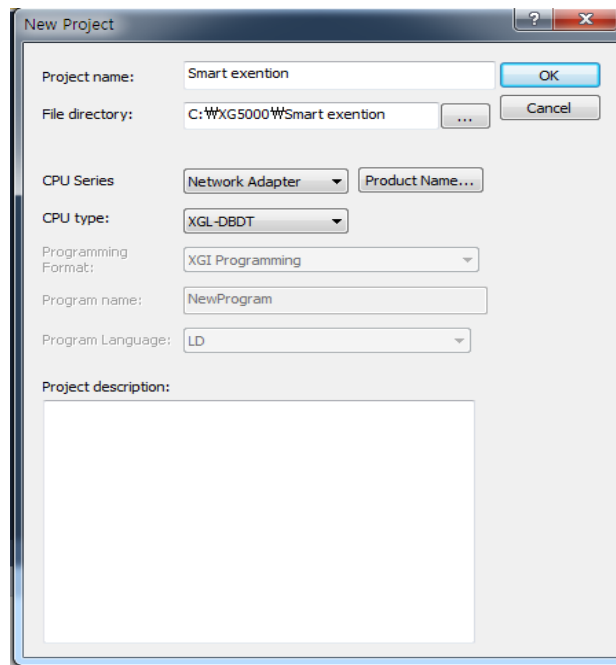

When you create a project, the project tree shown below will appear.

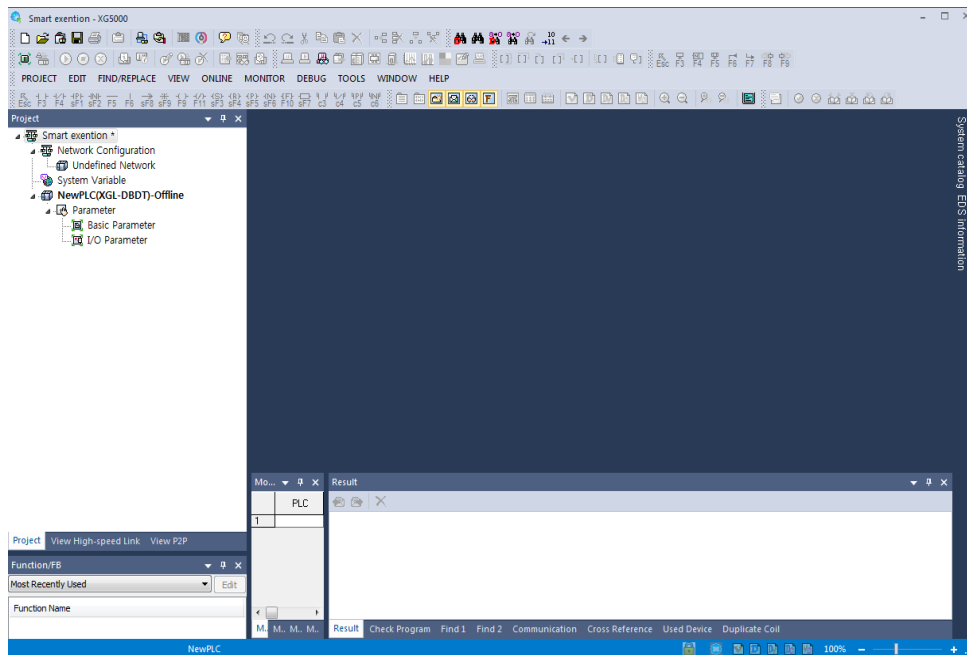

3.4.2 Communication device connection

(1) How to connect USB Communication device

- 1) Connect the cable directly to the USB connector of the Communication device.
- 2) [Online] → [Connection Settings], set the following connection options and click [Connect].

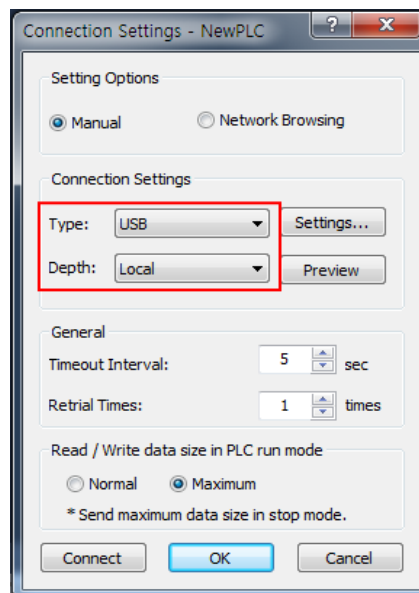

(2) Remote connection

- 1) [Online] → [Connection Settings], click [Network Browsing] in the connection options.

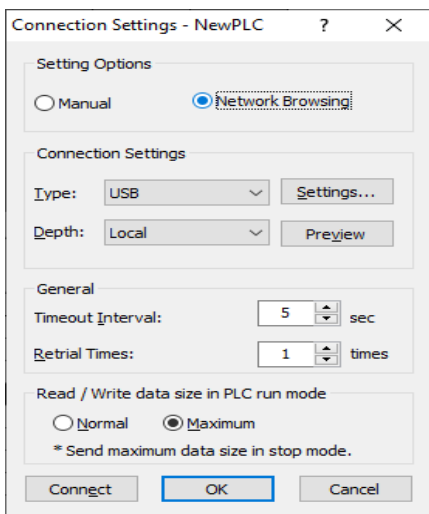

2) Set the Communication device in the order of connection as shown below and click "Connect".

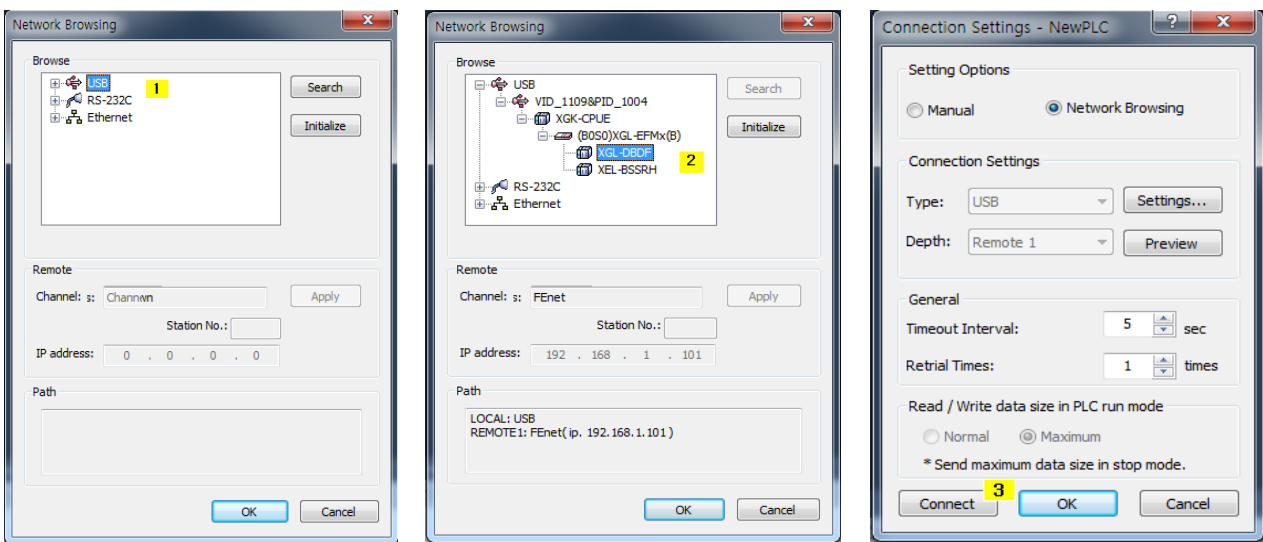

3.4.3 I/O synchronous

Set the PLC to Stop mode and click [Online] → [System Diagnostics] → Click the "I/O Sync" button at the bottom left of the [I/O Information] window.

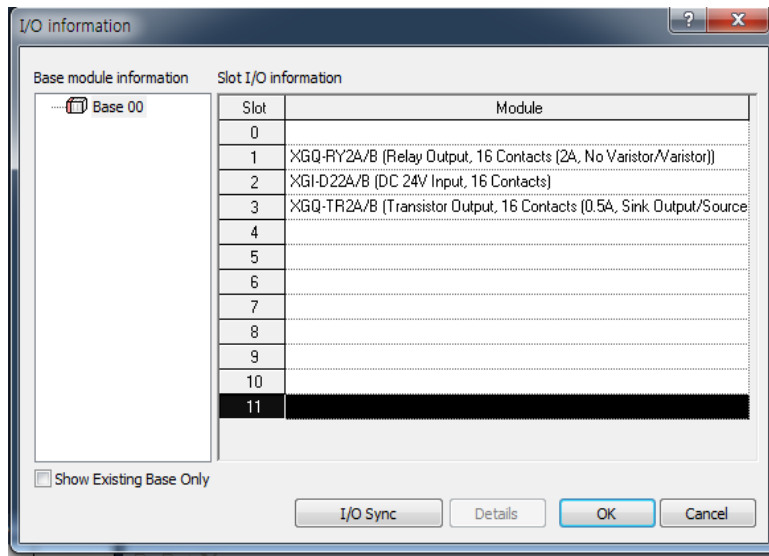

Confirm the contents of the message window and click "Yes".

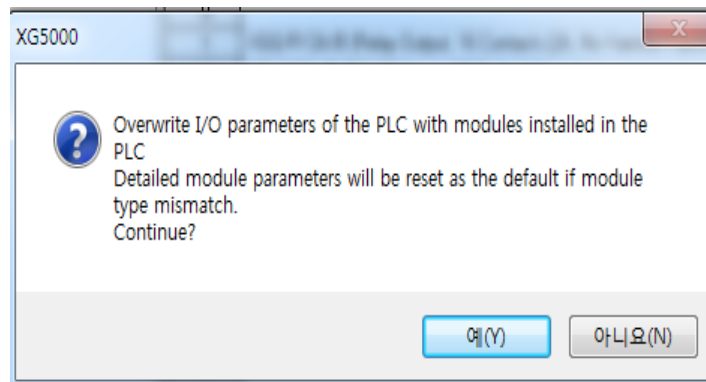

3.4.4 Basic parameter setting

Basic parameter setting determines basic items such as basic operation settings, communication basic settings and host table settings of Communication device. In order to make Ethernet communication, you must set basic parameters in the basic setting screen of the module window and download them.

(1) Basic Operation Settings

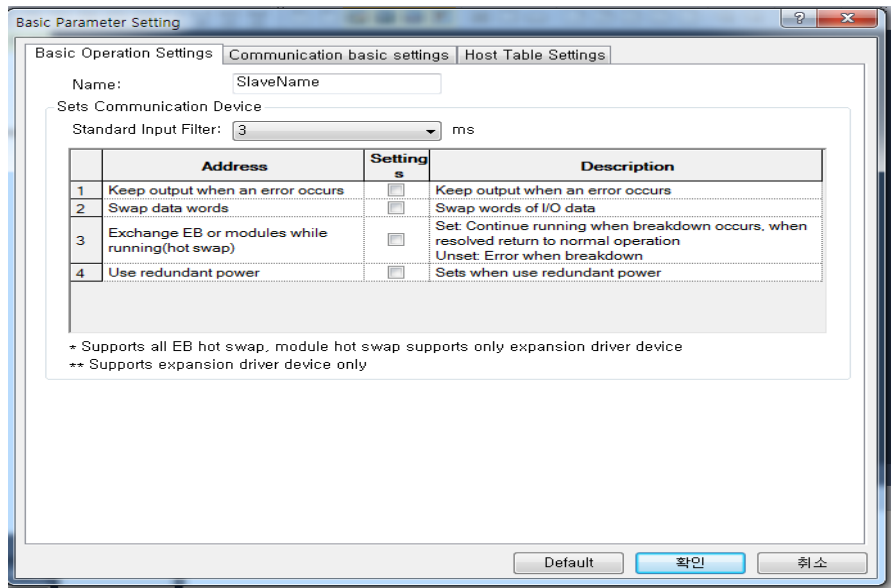

Classification	Content
Name	Set the name of the Communication device.
Standard input filter	Set the standard value of the input module input filter connected to the Communication device.
Hold output when switching run → stop	Output status setting of output module installed in communication device of Smart extension service when CPU mode is changed from run to stop. - Setting: Hold output when switching from run to stop - Non-setting: Clear output when switching from run to stop
Hold output when CPU or communication device error occurs	Output status of the output module installed in the communication device of the Smart extension service when an error occurs in the CPU or communication device. - Setting: Hold output when an error occurs - Non-setting: Clear output when an error occurs
EB or module swap during operation (hot swap)	This setting allows the exchange of EB system (the entire system including the communication devices mounted on the EB) or the module mounted on the EB during operation. - Setting: Continue operation when a fault occurs and normal operation when a fault is restored - Non-setting: Change to error mode when a fault occurs.
Power redundancy base	Enables the use of a power redundancy base for power redundancy. - Setting: Use power redundancy base - Non-setting: Do not use power redundancy base

Notes

- (1) In order to maintain the output in case of errors of Communication devices, emergency output setting for each channel must also be performed in the digital output module emergency output setting of [I/O parameter setting]. For the setting method, refer to 3.3.5 I/O module parameter setting.
- (2) When using Smart extension service, check “Use master communication device operation setting” in basic operation parameter setting of communication device setting during Smart extension setting of master.

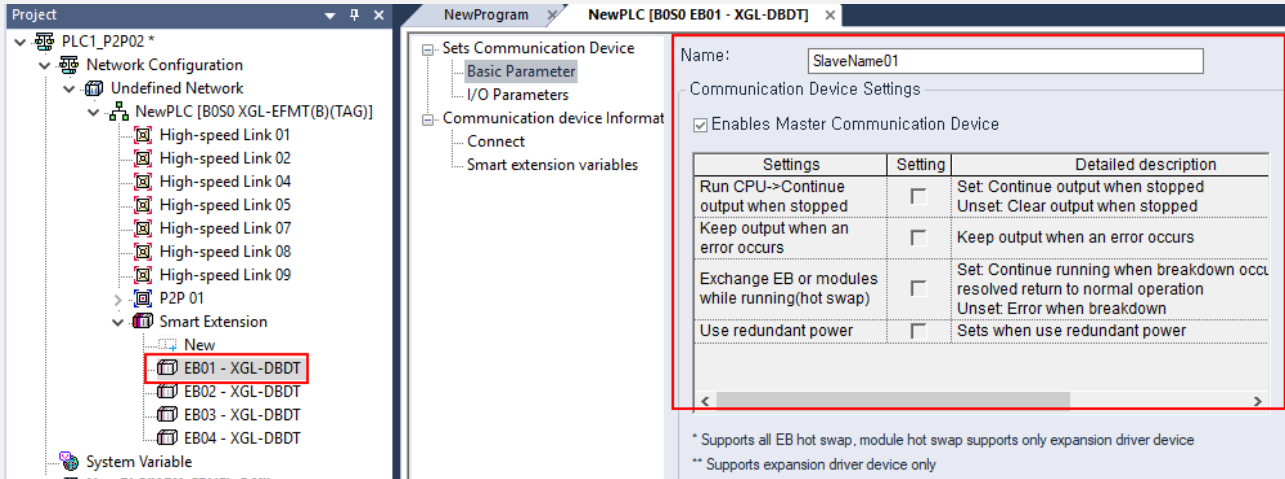

(2) Communication basic settings

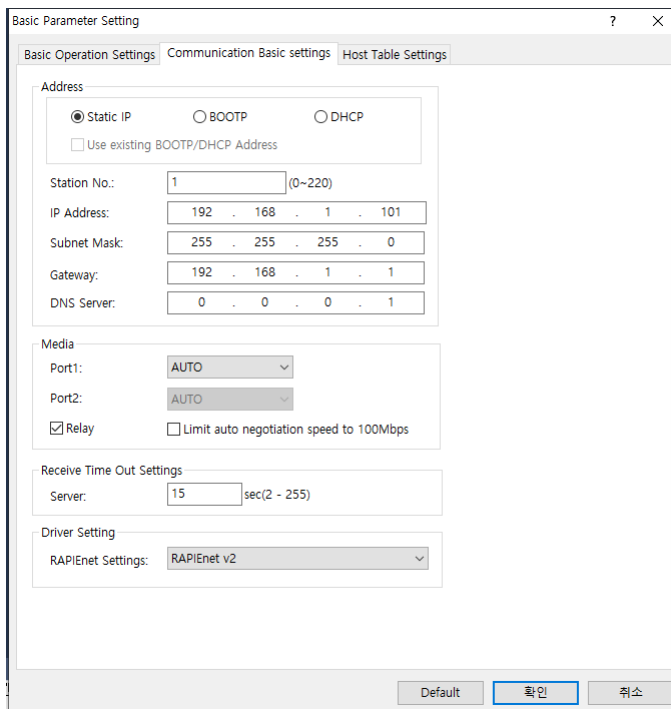

Item		Content
Address settings	Fixed IP allocation	Use the IP address, subnet mask, gateway, and DNS server set by the user.
	Using BOOTP	Immediately after the power is turned on, BootpServer connection is attempted at initialization time.
	Using DHCP	After connecting the DHCP server and cable, reset the Expansion device or turn the power off and on again, the IP address is automatically assigned from the DHCP server.
	Using BOOTP / DHCP existing assignment information	If the option is checked, if there is IP address information assigned by BOOTP or DHCP, the old data is automatically assigned to the Expansion device. If you want to assign a new IP through BOOTP or DHCP, be sure to disable this option.
	Station number	Specify the station number of the device to be used for MODBUS / TCP and RAPIEnet communication. The setting range is 0 ~ 220, so that it does not overlap with other devices on the network.
	IP address	Set the IP address of the Ethernet module.
	Subnet mask	This is the value for classifying whether the destination station is in the same network with its own station or not.
	Gateway	Set the gateway module address (router address) for sending and receiving data through a station or a public network that uses a different network from your own station.
	DNS server	Specifies the domain name server
Media setting	Port 1 / Port 2	Select the media you wish to use. ▷ AUTO: Automatically sets the media settings of the currently installed module. ▷ 100M/FULL: 100Mbps Full Duplex ▷ 1G/FULL: 1Gbps Full Duplex
	Relay	Used to send frames received on the port to the opposite port.

		If the communication speed of the relayed communication port is different, the relay function will not work.
	Limit auto negotiation speed to 100Mbps	This function limits the maximum connection speed to 100Mbps when media is set to AUTO.
Reception timeout time setting	On Server Mode	If there is no request for the set time from the client while the server is connected to the client, the server operation is finished assuming that a problem has occurred with the client system.
Driver setting	RAPIEnet setting	- RAPIEnet V2: Use the RAPIEnet service. - Disable: RAPIEnet is not used.

Notes

1. In the media setting, all items except “AUTO” are Force mode. The link setting may be wrong when connecting between AUTO set device and Force mode set device, so Expansion driver (V1.1 or higher), Smart I/O expansion type (V1.1 or higher) and Smart I/O block type (V2.1 or higher) products do not support the above link setting. In order to use it in force mode, the link partner must be set to the same force mode and the connecting cable must use a cross cable.

◆ Media setting example

Case	Device A Media setting	Device B Media setting	Result
1	AUTO	AUTO	Link up available
2	AUTO	α Force mode	Link up Unavailable
3	α Force mode	α Force mode	Link up available
4	α Force mode	β Force mode	Link up Unavailable

◆ Smart I/O expansion type link up with link partners set to AUTO even if set to 100M/FULL.

(3) Host table setting

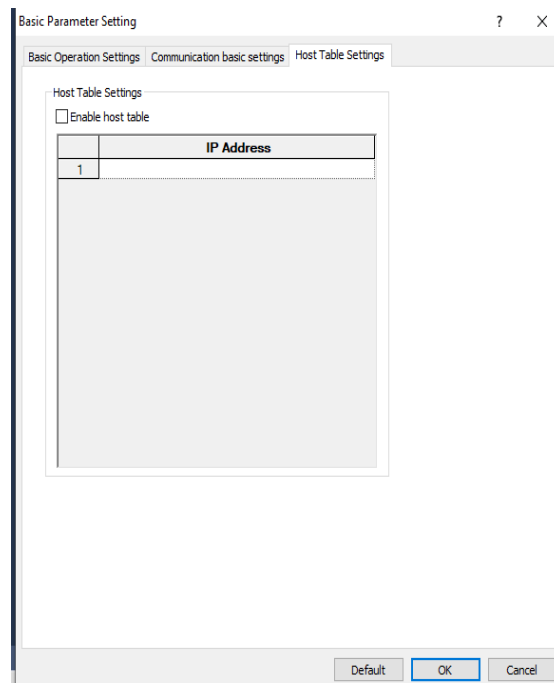

Classification	Content
Enable host table	Only the module of the IP address registered in the host table allows access to the Ethernet module. (Only applies to Modbus/TCP protocol.)
IP address	Register an IP address that allows connection.

Notes

Check when setting DHCP

(1) After confirming the IP address after setting the DHCP, connect the PLC to the PLC after downloading the parameters and perform [Online] -> [Communication Module Setting] -> [System Diagnosis] -> [Communication Module Information] or There are ways to make using the default settings that appear when you double-click a communication module shown in the project tree.

(2) For a dynamic IP address, if the power is off, the existing IP address may not exist.

(3) When making remote connection to the module with DHCP setting If the power of the remote side is turned on again as in (2), check the IP address for the remote station again.

(4) Refer to the table below for the PORT information for IP allocation using DHCP by OS version of Communication modules

Type	OS Version	PORT information for IP allocation using DHCP
Expansion driver	V1.00	Electric / Optical: PORT 1, Hybrid: PORT 2
	V1.10 or higher	PORT 1, 2
Smart I/O expansion type	V1.20 or less	Electric / Optical: PORT 1, Hybrid: PORT 1
	V1.30 or higher	PORT 1, 2
Smart I/O block type	V2.00	PORT 1
	V2.10 or higher	PORT 1, 2

3.4.5 I/O Parameter Setting

Explains how to set I/O module parameters of Communication device

(1) Select I/O parameter in the project window.

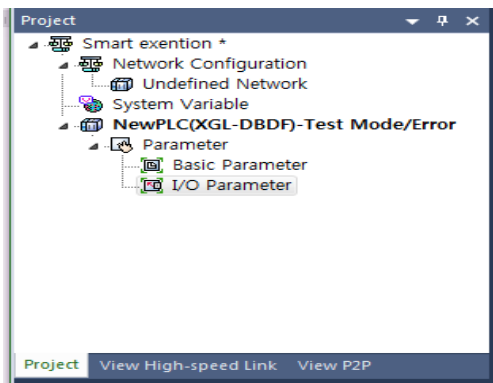

(2) I/O Module register

1) After switching the Communication device to STOP mode, [XG5000] → [online]→ [System Diagnostics] - [I/O Information] using I/O Sync function and register I/O modules.

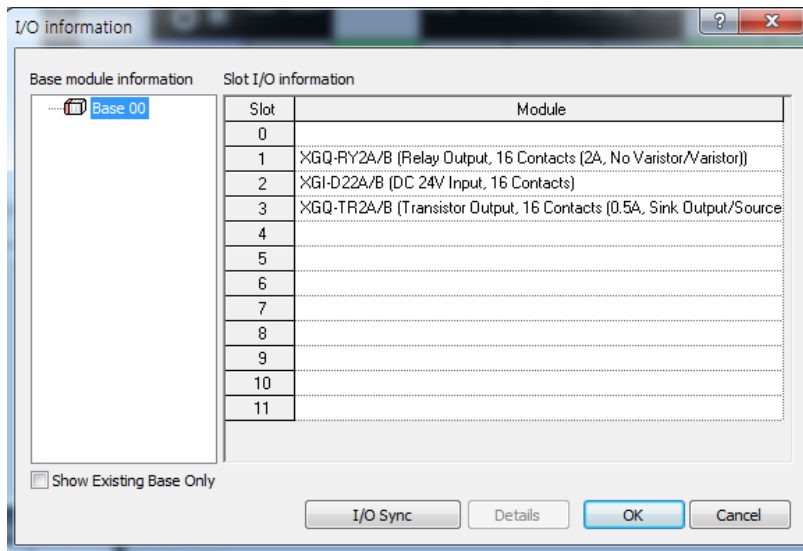

2) Register manually I/O modules per slot in the "I/O parameter" setting window of the project window.

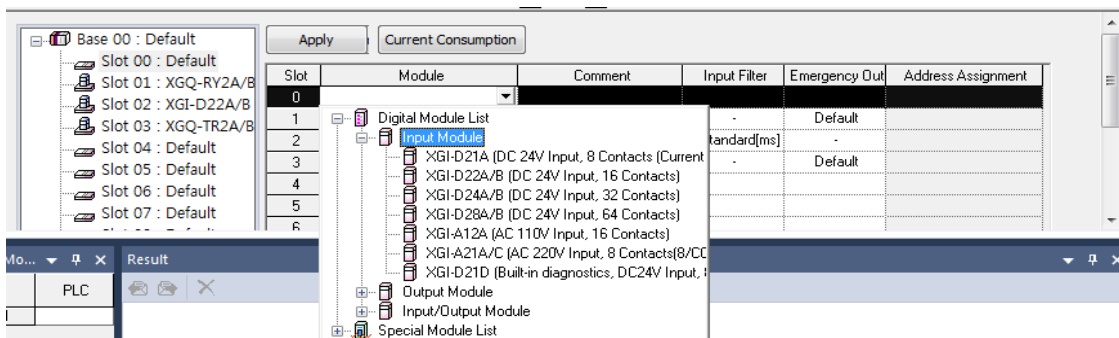

(3) I/O Parameter Setting

In the "I/O parameter" setting window, you can select the I/O module for which you want to set parameters (double-click the left mouse button) and then set individual operating parameters. After setting individual parameters, click "OK" button and write project.

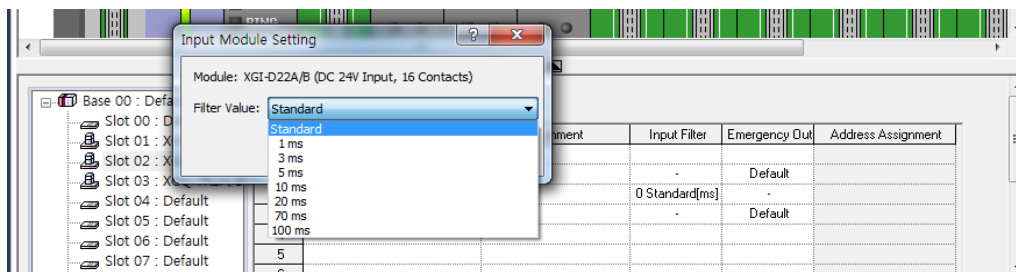

3.5 Station Number, IP address Setting

Station number and IP setting of Communication device products are available as follows.

How to set IP	IP setting value	Set Conditions	Station number switch position
Station number switch	192.168.1.100+A	The station number switch(A) is set to a number other than 0.	1~99
Fixed IP assign	Random value input	Set the station number switch to 0 and set the station number, IP, subnet mask, gateway, and DNS server.	0
BOOTP	Disabled	After setting the station number switch to 0, check "Use BOOTP" in the address setting parameter	0
DHCP	Disabled	After setting the station number switch to 0, check "Use DHCP" in the address setting parameter.	0

Notes

- (1) When the IP setting method or station number switch is changed, the parameters changed after the Communication device product reset are applied.
- (2) If station number switch number is changed after setting fixed IP allocation, IP of module operates as station number switch. Then, when the station number is changed to 0, it is operated as fixed IP.

3.5.1 Method by station number switch

The station number and IP address can be set with the rotary switch located on the front of Communication device. If the station number switch value is not '0', the station number and IP address of the Communication devices are automatically allocated according to the station number switch value. When the setting value of the station number switch is 'A', the station number and IP address allocation rules of the Communication devices are as follows.

Classification	Set Value
Station number	A
IP address	192.168.1.'100+A'
Subnet mask	255.255.255.0
Gateway	192.168.1.1
DNS server	0.0.0.1

Example) when the station number switch is 10

Classification	Set Value
Station number	10
IP address	192.168.1.110
Subnet mask	255.255.255.0
Gateway	192.168.1.1
DNS server	0.0.0.1

3.5.2 XG5000 parameter setting (Static IP)

Connect to the Communication device and select "Static IP" on the [Communication basic settings] tab in the [Basic Parameter Setting] window and set the desired station number, IP address, subnet mask, gateway and DNS server to the value you want Type. If you set the station number switch to '0' and reset the communication device after downloading, the changed parameter is applied.

Basic Parameter Setting

Basic Operation Settings | Communication basic settings | Host Table Settings

Address

Static IP BOOTP DHCP

Use existing BOOTP/DHCP Address

Station No.: 1 (0~220)

IP address: 192 . 168 . 1 . 101

Subnet Mask: 255 . 255 . 255 . 0

Gateway: 192 . 168 . 1 . 1

DNS Server: 0 . 0 . 0 . 1

Media

Port1: AUTO

Port2: AUTO

Relay

Receive Time Out Settings

Server: 15 sec(2 - 255)

Driver Setting

RAPIEnet Settings: RAPIEnet v2

Default OK Cancel

3.5.3 Setting by BOOTP

Connect to the Communication device and select "BOOTP" in the [Communication basic settings] tab in the [Basic Parameter Setting] window. If you set the station number switch to '0' and reset the Communication device after downloading, the changed parameter is applied.

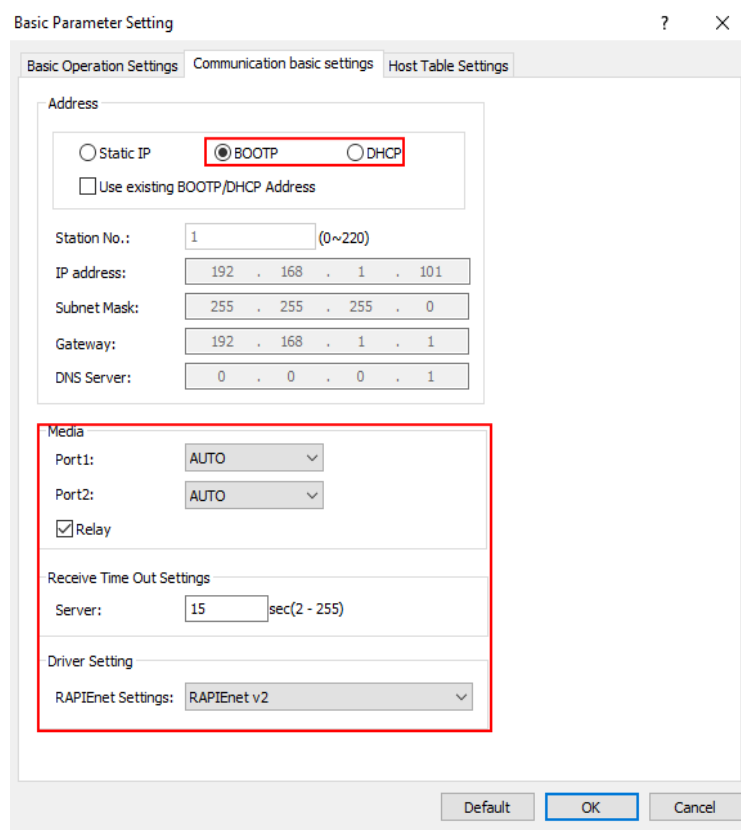

To create the station number and IP address using BOOTP, connect the Ethernet cable between the PC and the Communication device and execute [BootpServer.exe] in the XG5000 installation folder.

AddrCalculator.exe	2/13/2020 2:49 PM	Application	48 KB
ApiTPG.dll	2/13/2020 1:44 PM	Application extens...	38 KB
BasicParameter.dll	2/13/2020 1:45 PM	Application extens...	785 KB
BCGCBPRO2800u110.dll	2/13/2020 1:44 PM	Application extens...	10,794 KB
BootpServer.exe	2/13/2020 2:49 PM	Application	1,905 KB
BootpServer.ini	5/31/2019 11:08 AM	Configuration sett...	1 KB
BugslayerUtil.dll	2/13/2020 1:44 PM	Application extens...	33 KB
CANopenExt.dll	2/13/2020 2:11 PM	Application extens...	992 KB
Chart.dll	2/13/2020 1:46 PM	Application extens...	113 KB

If the power of the Communication device is reset while BootpServer.exe is running, you can check the Communication device list with the BOOTP function enabled as shown below.

The physical address of Communication device (MAC address) can be checked on the sticker attached to the side of the product. After selecting the device to connect from MAC address list, input IP address, Subnet mask, and Gateway address and press Write button to apply the setting value. To set the IP address, the station number switch must be in the 0 position.

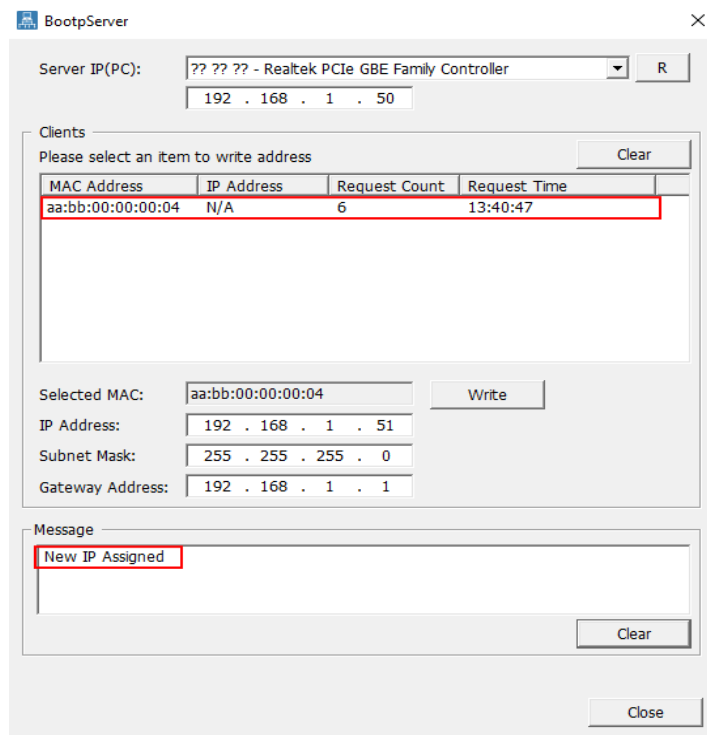

After selecting the MAC of the Communication device and inputting the IP address, subnet mask and gateway to assign, click the "Write" button and the IP is assigned. If there is no abnormality, "New IP Assigned" is displayed in the message window.

3.5.4 Setting by DHCP

Connect to the Communication device and select "Use DHCP" in the [Communication basic settings] tab in the [Basic Parameter Setting] window. If you set the station number switch to '0' and reset the communication device after downloading, the changed parameter is applied.

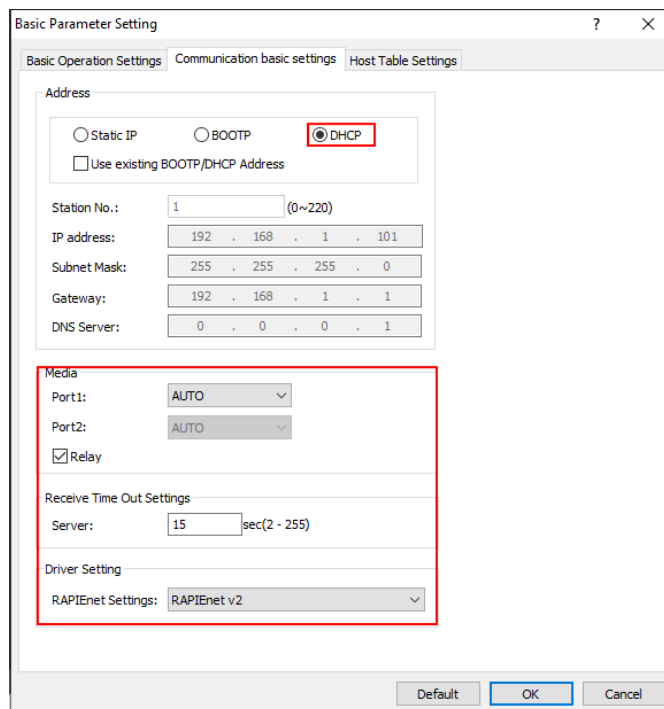

After connecting the cable to the DHCP server and resetting the power to the Communication device, the IP address will be automatically assigned to the DHCP server.

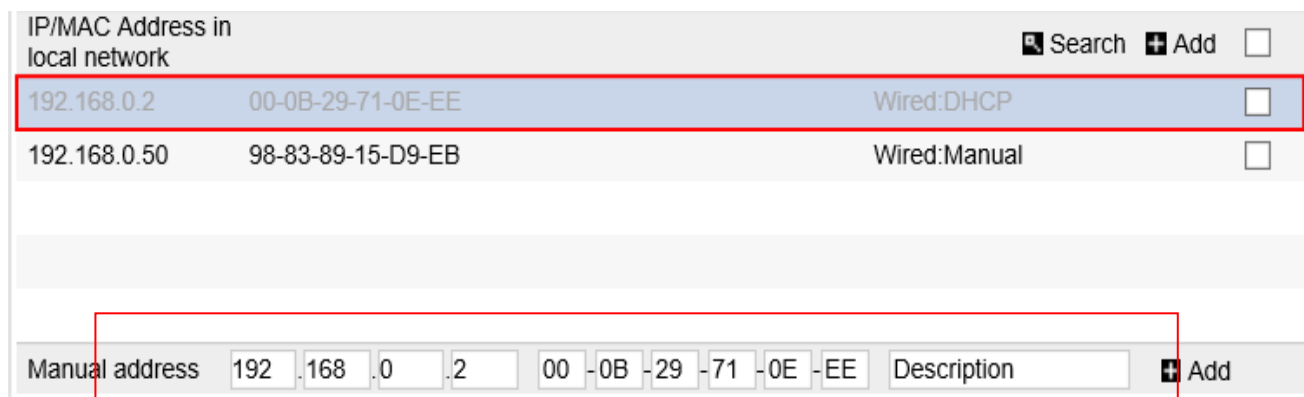

3.5.5 Assigning station number when IP setting by BOOTP, DHCP

The number of the Communication device set by BOOTP and DHCP is automatically assigned according to the assigned IP address.

When the IP address assignment value is 'A, B, C, D', the station number assignment rule of the Communication device is as follows.

Classification	Station address
Setting the IP address Last digit (D) = 2 ~ 220	D
Setting the IP address Last digit (D) = 221 ~ 254	220

Example) 1. If the IP address is "192.168.1.120": Station number 120

2. If the IP address is "192.168.1.240": Station number 220

Notes

- (1) Please refer to the appendix for check items before using BootpServer provided by XG5000.
- (2) DHCP (Dynamic Host Configuration Protocol) is used when you want to use dynamic IP (use when connecting ADSL line) without using Fixed IP.
- (3) If the station number switch is changed from 0 to another number and the power is reset, the station number switch setting IP is set.

3.6 System diagnosis

The system diagnosis function indicates the overall service status and information of the communication module. It shows detailed online status such as link type, link information and O/S version so that users can diagnose and debug data send/receive relationship of current communication module.

3.6.1 Running the Diagnostics

After connecting XG5000, select [Online] -> [Communication Module Setup and Diagnosis] -> [System Diagnosis] to display the base and slot information for the currently installed module and display normal operation status.

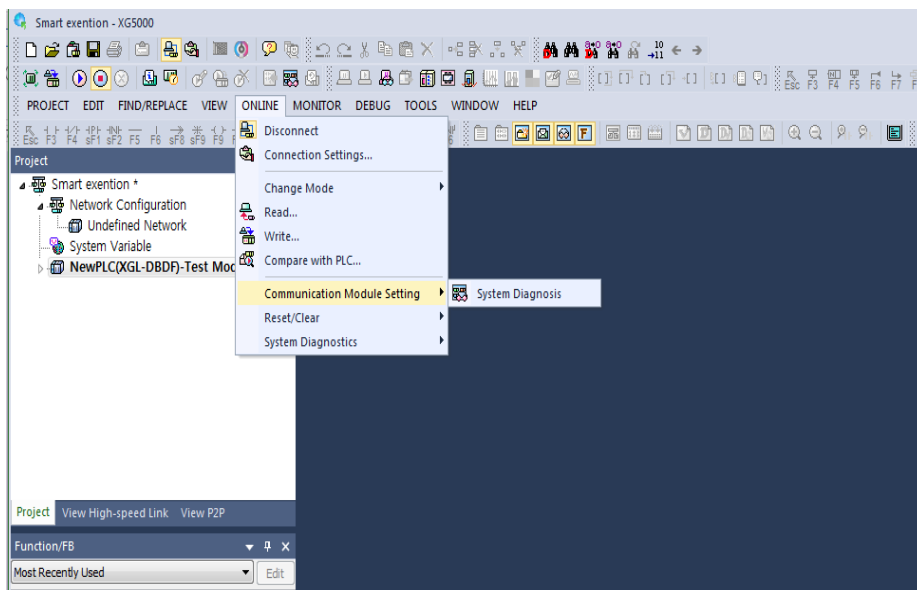

Displays the currently mounted module and status of each module.

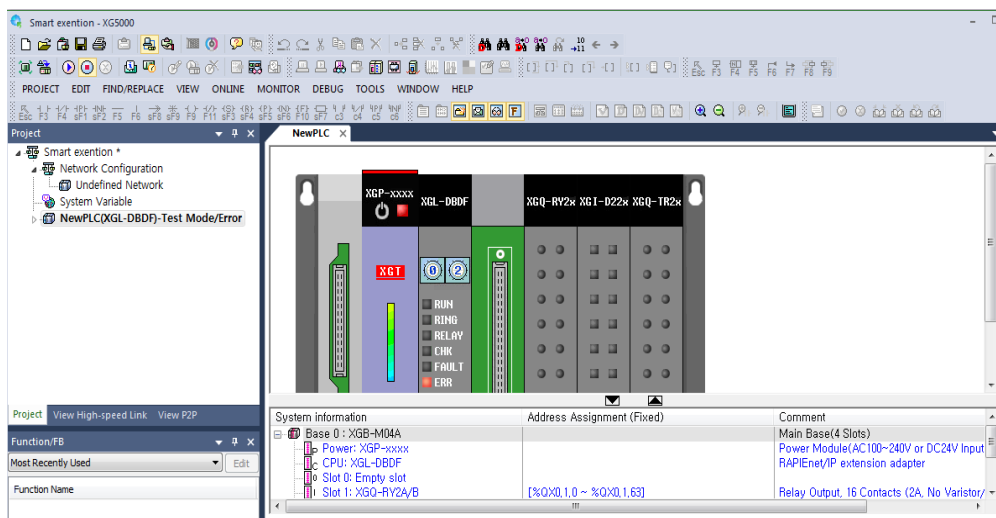

3.6.2 Types of diagnostic functions

You can see the list of diagnostic functions provided by selecting the Communication device (right-click of the mouse).

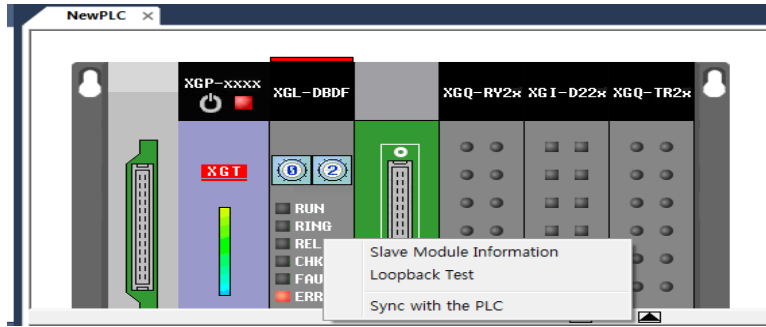

Classification	Content
Slave module information	It shows basic information, hardware and communication status of communication device.
Loopback test	It is a function to check whether there is an abnormality in the port of the local module, and performs loopback test for each port.
Sync with the PLC	Read the information set in PLC and display on XG5000 screen.

Chapter 4 Smart Extension Service

4.1 Overview

Smart extension service provides user convenience by simplifying RAPIEnet, EtherNet/IP network configuration and data transmit and receive setting. In addition, RAPIEnet and EtherNet/IP protocols enable various network environments.

For more information on Smart expansion service, refer to “Chapter 4 Smart extension service” of the Ethernet module user's manual.

4.1.1 Communication device product configuration

The table below shows the configuration of Smart extension services.

Classification	Model name	Max. station number	Parameter setting	Service	Available communication								
Ethernet module (Master)	XGL-EFMTB	64 station <small>Note 1)</small>	XG5000	High Speed Link, P2P, Smart extension, Smart function	RAPIEnet/IP (IEC62439-7) EtherNet/IP Modbus/TCP								
	XGL-EFMFB												
	XGL-EFMHB												
Extension driver	XGL-DBDT			64 station <small>Note 1)</small>	XG5000	Smart extension, Smart function Slave function	RAPIEnet/IP (IEC62439-7) EtherNet/IP Modbus/TCP						
	XGL-DBDF												
	XGL-DBDH												
Smart I/O extension	XEL-BSSRT							64 station <small>Note 1)</small>	XG5000	Smart extension, Smart function Slave function	RAPIEnet/IP (IEC62439-7) EtherNet/IP Modbus/TCP		
	XEL-BSSRF												
	XEL-BSSRH												
Smart I/O block	GEL-TR4C/C1											64 station <small>Note 1)</small>	XG5000
	GEL-DT4C/C1												
	GEL-D24C												
	GEL-RY2C												
	GEL-AV8C												
	GEL-AC8C												
	GEL-DV4C												
GEL-DC4C													
Multiport RAPIEnet Switch	XOL-ES4T	-	-	Communication switch	RAPIEnet/IP (IEC62439-7) Ethernet (EtherNet/IP)								
	XOL-ES4H												

Note 1) A maximum of one Multiport RAPIEnet Switch can be connected per network.

4.1.2 Performance metrics by protocol

Communication devices operate as RAPIEnet, EtherNet/IP, Modbus/TCP integrated server. The performance of each protocol is as follows.

Item	Protocol		
	RAPIEnet v2	EtherNet/IP	Modbus/TCP
Slave (server)	Response within 100 μ S Sending after receive	Less than 3 ms response Transmission in asynchronous communication cycle Minimum frequency: 5 ms	Less than 3 ms response Sending after receive
System Performance (16 stations)	Less than 5 ms	Less than 50 ms	N times increase

4.2 Smart Extension Service Setting

4.2.1 Communication device station number, IP setting

In order to use the Smart extension service, the station number or IP of the Communication device must be set first. Refer to “3.4 Station No. and IP address setting” for how to set the station number and IP address of the Communication device.

4.2.2 Adding Communication device

(1) Smart extension wizard

With the Smart extension wizard, you can proceed to configure the Smart extension service such as adding Communication device, setting Communication device, setting PLC area. However, I/O parameter settings during communication device settings must be proceeded separately.

- 1) If you select 'Next' in the Smart extension wizard's window, the detailed settings window appears. In the detail setting window, you can add a Communication device or specify the connection information of the Communication device. (Click the cell of the item you want to set.)

Details

No. of Communication Devices: (1 ~ 63)

EB No.	Module type	Module Name	Station	IP address	Protocol	Apply
1	Expansion drive	XGL-DBDT	1	192.168.1.101	RAPIenet	<input checked="" type="checkbox"/>
2	Expansion drive	XGL-DBDT	2	192.168.1.102	RAPIenet	<input checked="" type="checkbox"/>
3	Expansion drive	XGL-DBDT	3	192.168.1.103	RAPIenet	<input checked="" type="checkbox"/>
4	Expansion drive	XGL-DBDT	4	192.168.1.104	RAPIenet	<input checked="" type="checkbox"/>

< Back

Item	Content
No. of Communication devices	Set the number of Communication devices to be added to the Smart extension service.
Auto scan	The currently connected Communication device is added and Communication device connection information is specified automatically. - Only available online.
EB No.	Specifies the EB number of the Communication device to be added.
Module type	Specifies the module type of the Communication device to be added.
Module name	Specifies the module name of the Communication device to be added.
Station number	Specifies the station number of the Communication device to be added. The station number set in the corresponding communication device must be specified. - The station number range of the Communication device is 0 ~ 220.
IP address	Specifies the IP address for the Communication device to be added. The station number set in the corresponding Communication device must be specified.
Protocol	Specify the communication device to add and the protocol to use.
Application	Check the application box of the Communication device that will store the connection information.

2) In PLC area setting window, memory setting for 'input/output variable' and 'diagnostic variable' is available. The address and size are automatically changed according to the Communication device added in the advanced detailed settings. (However, the memory area setting counts Smart extension service as the highest priority. An area that overlaps with the memory area used by other services may occur.) When you are finished, select 'Finish'.

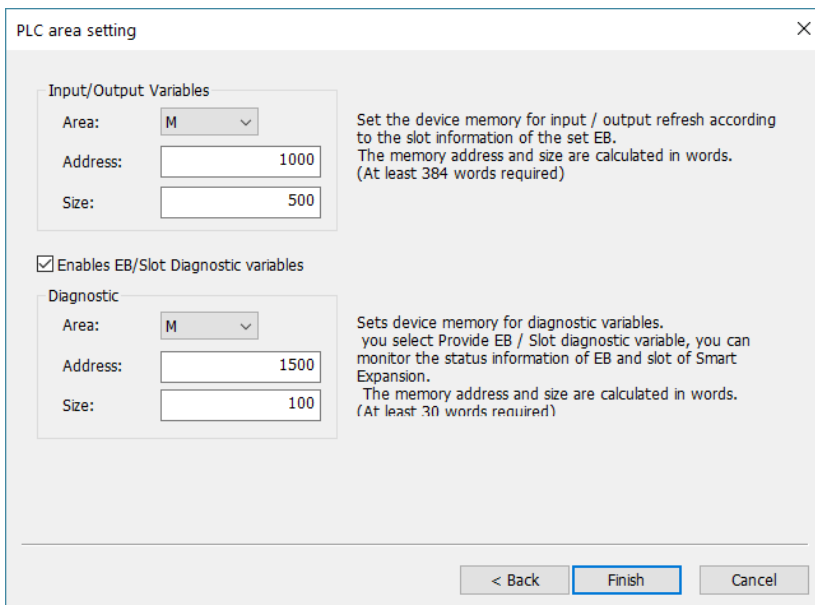

Item	Content	
Input/Output variables	Area	Set the memory area of the Ethernet module (Master) to map the input/output variables of the Communication device. - Select between P/M/D (XGK) and I/Q/M/W (XGI) areas.
	Address	Set the memory start address of the Ethernet module to map the input/output variables of the Communication device.
	Size	Set the size of memory area of the Ethernet module to map the input/output variables of the Communication device. -The Communication device requires 384 words per unit.
Enables EB/Slot diagnostic variables	Enable/Disable the use of diagnostic variables.	
Diagnostic variables	Area	Set the memory area of the Ethernet module (Master) to map the Diagnosis variables of the Communication device. - Select between P/M/D (XGK) and I/Q/M/W (XGI) areas.
	Address	Set the memory start address of the Ethernet module to map the Diagnosis variables of the Communication device.
	Size	Set the size of memory area of the Ethernet module to map the Diagnosis variables of the Communication device. - The basic diagnostic variable of Smart extension service requires 22 words. - 8 words per 1 unit of Communication device are required.

(2) Direct input

Here's how to add a Communication device offline or perform a Communication device setup without using the Smart extension wizard.

1) Right-click the added Smart extension and select [Add Item] - [Add Communication device], or select 'New' from the Smart extension submenu in the project window.

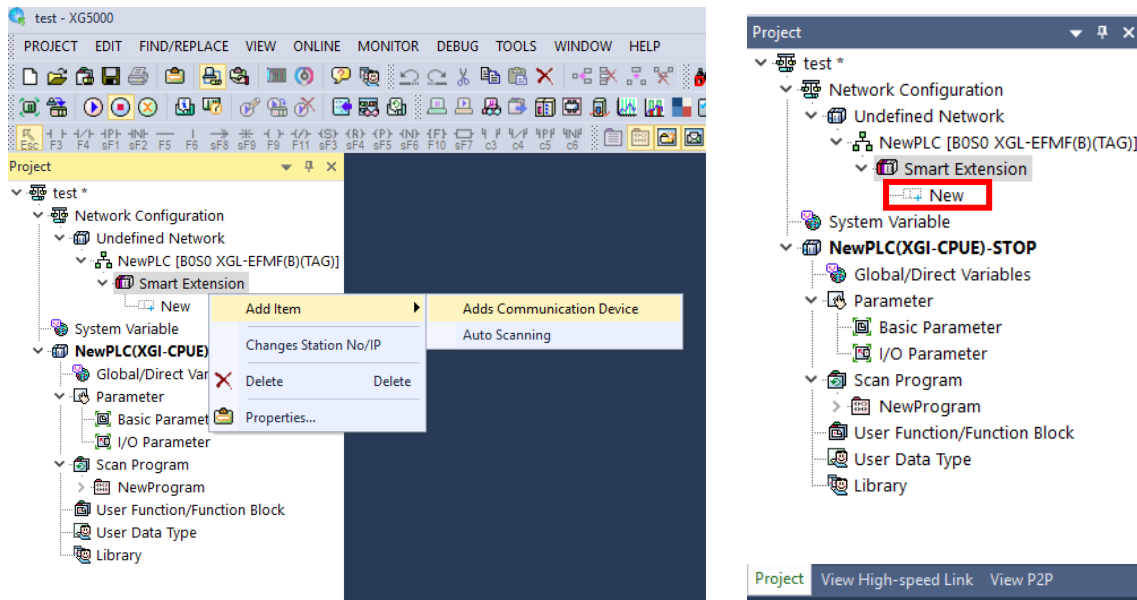

2) You can add Communication device of the Smart extension service by specifying the connection information in the Connection tab of the [Add Communication device] window and selecting 'OK'.

Item	Content
EB No.	Specifies the EB number of the Communication device to be added. Communication device channel number connected to Ethernet module in the Smart extension service. - EB number setting range is 0 ~ 63
Protocol type	Specifies the connecting protocol of the Communication device to be added.
Station number	Specifies the station number of the Communication device to be added. The station number set in the corresponding Communication device must be specified. - The station number range of the Communication device is 0 ~ 220.
IP	Specifies the IP address of the Communication device to be added.
Module type	Specifies the module type of the Communication device to be added.
Image	Select the image of the Communication device. - Use the desired photo file as the image of the Communication device. - This image is only used in the 'Configure Communication device Connection' function.
EDS information	Select the EDS information of the Communication device. - EDS information is automatically assigned when adding a Communication device and cannot be modified.

4.2.3 Communication device setting

Smart extension service has a function to set Communication device remotely.

- (1) Select the device to be set in 'Smart extension' of the project window (left click of the mouse).

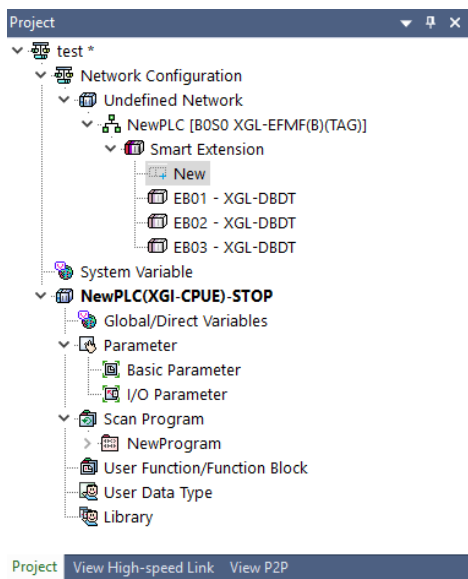

(2) In 'Basic operation parameter' of the Communication device setting tree, Set the name and operation setting of Communication device

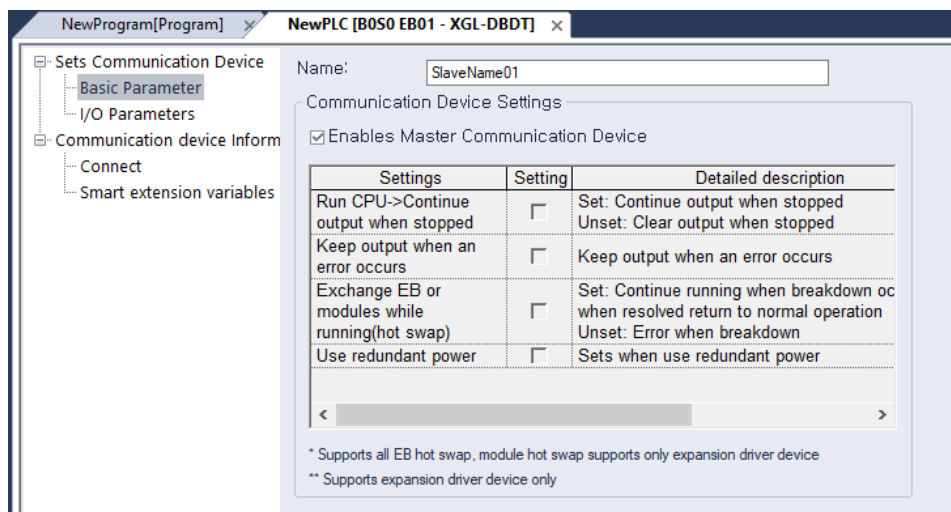

Item	Content
Name	Set the name of the Communication device.
Set the Communication device operation of the master.	Enable when you want to automatically reflect the Communication device operation setting values that can be set in the master setting.
Hold output when converting run to stop.	Output status setting of output module installed in Communication device of Smart extension service when CPU mode is changed from run to stop. - Setting: Maintain output when switching from run to stop - Non-setting: Clear output when switching from run to stop
Hold output when CPU or Communication device error occurs.	Set output holding status of output module according to PLC operation status.. - Setting: Hold output when an error occurs - Non-setting: Clear output when an error occurs
EB or module swap during operation (hot swap)	This function enables EB or module change during operation. - Setting: In case of EB or module failure, no error handling is performed. Normal operation when restoring EB or module failure - Non-setting: Perform error handling when EB or module failure occurs

	However, the module change function during operation provides only the Expansion driver.
Use redundant power	<p>This function enables the use of power redundancy base for power redundancy.</p> <ul style="list-style-type: none"> - Setting: Use dual power base - Non-setting: Do not use power dual base <p>The power redundancy base option applies only to the Expansion driver. Must be set when using a power dual base.</p>

(3) In 'I/O Parameter' of Communication device setting tree, I/O parameter setting of PLC equipped with Communication device can be set. When a Communication device is added using auto scan, parameter information of I/O module installed in the PLC is automatically set.

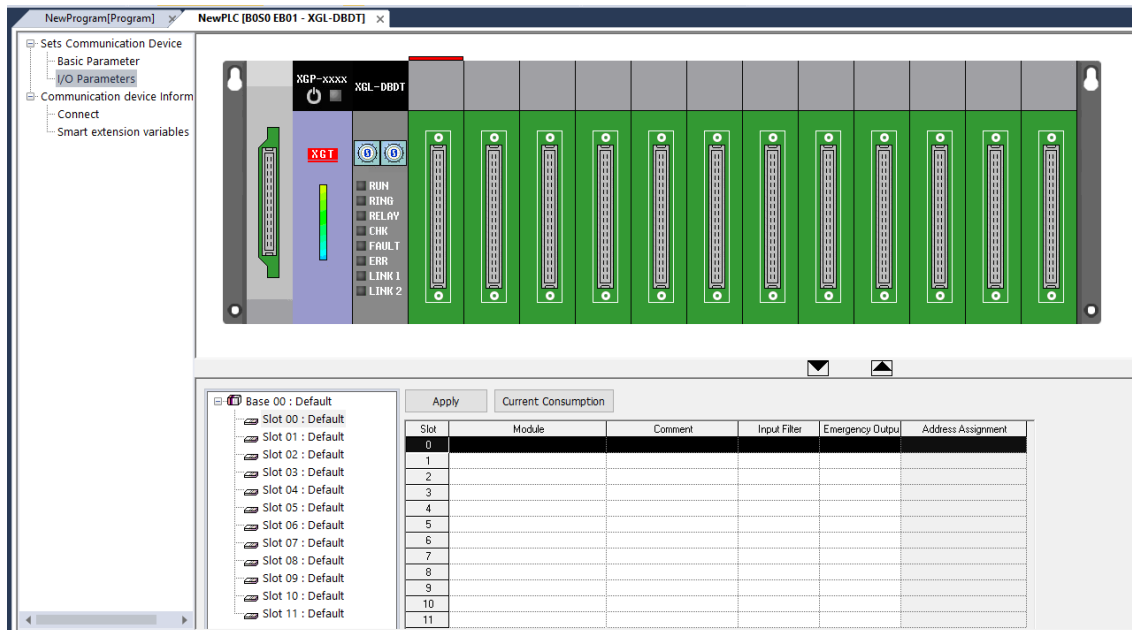

Item	Content
Module	Select the mounted module.
Description	<p>write a comment</p> <ul style="list-style-type: none"> - Select the comment cell you want to last with the left mouse button and create it. - The comment is not stored in the module.
Input filter	Select an input filter value. (Input module/input and output module)
Emergency output	Emergency output can be set. (Output module/input and output module)
Address assignment	The Communication device does not support the function of checking allocation information.

(4) In 'Connection' of Communication device information tree, you can specify connection information (EB number, connection protocol type, station number, IP address, and image) of Communication device.

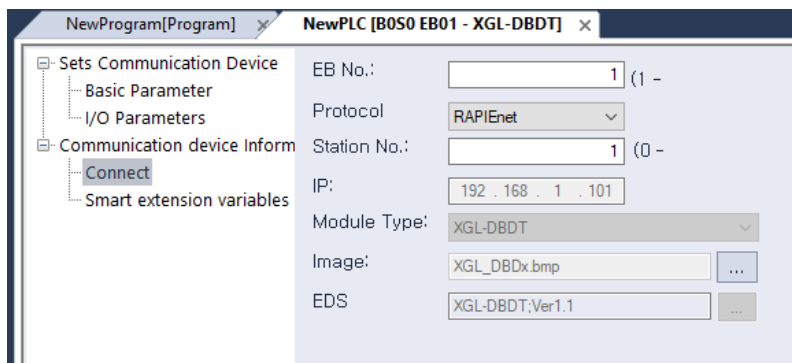

Item	Content
EB No.	Specify the EB number to be assigned to the Communication device.
Protocol type	Specify the protocol type to be used for communication with the Communication device.
Station number	Specify station number set to the Communication device. - Activated when protocol type is RAPIenet.
IP	Specify IP address number set to the Communication device. - Activated when protocol type is EtherNet/IP.
Module type	Specifies the module type of the Communication device. - Module type is automatically assigned when adding a Communication device and cannot be modified.
image	Assigns the image of the Communication device. - Use the desired photo file as the image of the Communication device. - This image is only used in the 'Configure Communication device Connection' function.
EDS information	Assigns the EDS information of the Communication device. - EDS information is automatically assigned when adding a Communication device and cannot be modified.

4.3 Smart Extension Diagnosis Function

Smart extension service provides diagnostic function to check the status of the service. The service status of Smart extension service by using service status, communication module history view, diagnostic variables, Communication device connection configuration, EIP cycle/detailed setting list.

4.3.1 Status by service (Smart extension)

Check the operation status, service count, and error count of the Smart extension service in the service status. (Service-specific status can only be checked while online.)

- (1) Select [Online]-[Communication module setting]-[System diagnosis].

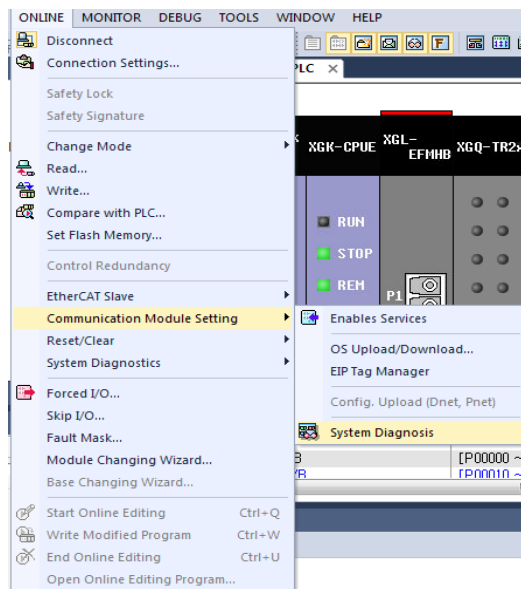

- (2) In the [System Diagnosis] window, right-click the "Ethernet module image area" and select the service-specific status.

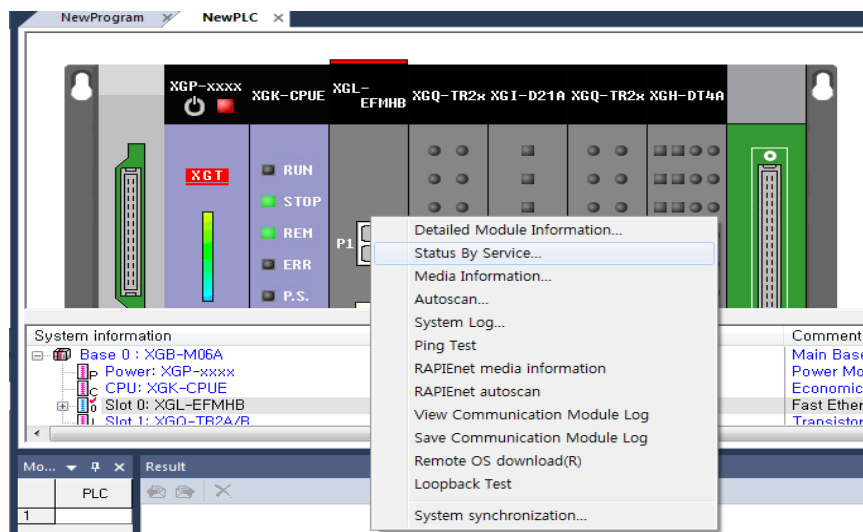

(3) Check the service status of the Smart extension by selecting the [Status by Service]→[Smart Extension] tab.

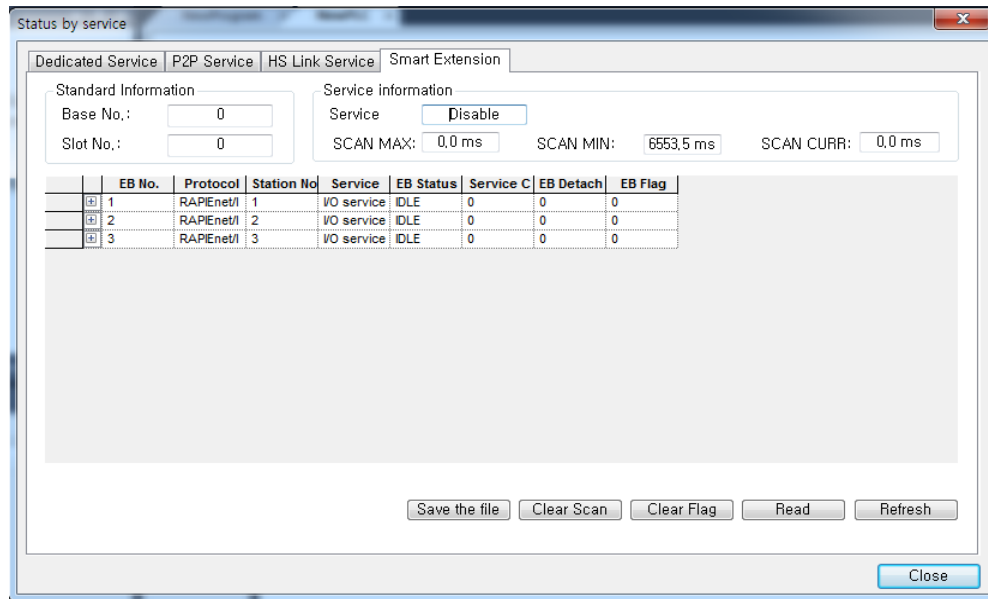

Item	Content																		
Base number	Displays the base number on which the Ethernet module is mounted.																		
Slot number	Displays the slot number on which the Ethernet module is mounted.																		
Service status	Displays the enabled status of the Smart extension service. - Types of service status and descriptions are as follows.																		
	<table border="1"> <thead> <tr> <th>Service status type</th> <th>Description</th> </tr> </thead> <tbody> <tr> <td>IDLE</td> <td>The slave to be controlled is not recognized by the network.</td> </tr> <tr> <td>DETECTING</td> <td>Searching for a Smart extension slave.</td> </tr> <tr> <td>STATE_CFM</td> <td>Smart extension slave has been checked.</td> </tr> <tr> <td>PRM_DONE</td> <td>The parameter download is completed to the slave.</td> </tr> <tr> <td>IO_PRM_MISS_MATCH</td> <td>The I / O list of the parameter and the mounted I / O list on slaver are different.</td> </tr> <tr> <td>WORKING</td> <td>Smart extension service is normally run</td> </tr> <tr> <td>DETACH</td> <td>The Communication device (slave) has been detached during control.</td> </tr> <tr> <td>Disable</td> <td>Link Enable is not specified</td> </tr> </tbody> </table>	Service status type	Description	IDLE	The slave to be controlled is not recognized by the network.	DETECTING	Searching for a Smart extension slave.	STATE_CFM	Smart extension slave has been checked.	PRM_DONE	The parameter download is completed to the slave.	IO_PRM_MISS_MATCH	The I / O list of the parameter and the mounted I / O list on slaver are different.	WORKING	Smart extension service is normally run	DETACH	The Communication device (slave) has been detached during control.	Disable	Link Enable is not specified
	Service status type	Description																	
	IDLE	The slave to be controlled is not recognized by the network.																	
	DETECTING	Searching for a Smart extension slave.																	
	STATE_CFM	Smart extension slave has been checked.																	
	PRM_DONE	The parameter download is completed to the slave.																	
	IO_PRM_MISS_MATCH	The I / O list of the parameter and the mounted I / O list on slaver are different.																	
	WORKING	Smart extension service is normally run																	
DETACH	The Communication device (slave) has been detached during control.																		
Disable	Link Enable is not specified																		
SCAN MAX	Smart extension service displays the maximum scan cycle of the network.																		
SCAN MIN	Smart extension service displays the minimum scan cycle of the network.																		
SCAN CURR	Smart extension service displays the current scan cycle of the network.																		
EB No.	Displays the EB number of the Communication device.																		
Protocol	Displays the protocol type used for connection with the Communication device.																		
Station No/IP	Displays the station number/IP of the Communication device. - Displays the station number when the protocol type is RAPIenet. - Displays the IP address when the protocol type is EtherNet/IP.																		
Service	Displays currently active services. - I/O service: Services provided by Communication devices equipped with Smart extension function -Event service: EtherNet/IP Client Service																		
EB status	Displays the current EB status. - WORKING: The service is operating normally. - IDLE: The service is not working.																		
Service count	Displays the service operation counts currently.																		
Error count	Displays the count of errors that have occurred currently.																		
EB detachment count	Displays the EB detachment counts that have occurred currently.																		
EB flag	Flag is displayed according to the type of error occurred when an error occurs in EB.																		

Slot No. (slot)	Displays the slot number (EB).
Type(slot)	Displays the module type installed in the slot (EB). - For EIP clients, displays the service type.
Status(slot)	Displays the service status of the slot (EB).
Block status(slot)	Display the status of that service block. - This feature is only available for EIP clients.
Error code (Slot)	The error code of the service is displayed. - This feature is only available for EIP clients.
Service count(slot)	The service count of the service is displayed. - This feature is only available for EIP clients.
Error count(Slot)	The error count of the service is displayed. - This feature is only available for EIP clients.
Slot flag (slot)	Flag is displayed according to the type of error occurred when an error occurs in slot.
File save	Saves the current status of Smart extension service as a file.
Clear scan	Initializes the scan information. Initializes the SCAN MAX and SCAN MIN values.
Clear flag	Initialize the EB flag and slot flag (slot). - Error flag history is initialized.
Read continuously	Smart extension service status is updated continuously.

4.3.2 View Communication Module Log

Check the event history and communication history of the Ethernet module by using the communication module history view function of system diagnosis. In the event history, event history such as joining and dropping of communication device nodes and mode switching history of communication module can be checked. In communication history, communication error history such as response waiting time exceeded, CRC error history, etc. can be checked.

(1) Select [Online]-[Communication module setting]-[System diagnosis].

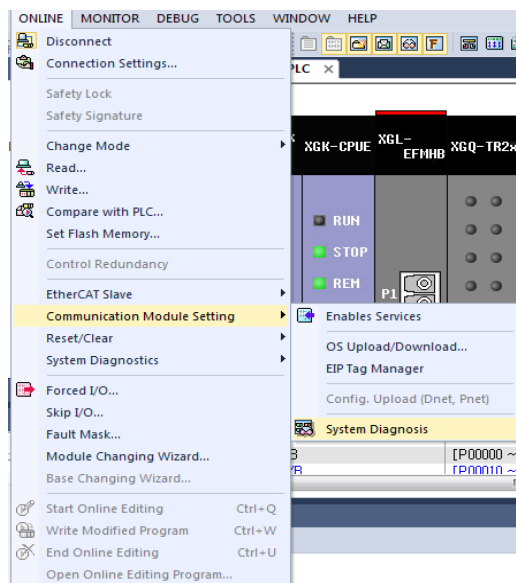

(2) In the [System Diagnosis] window, right-click the "Ethernet module image area" and select the [View communication module log]

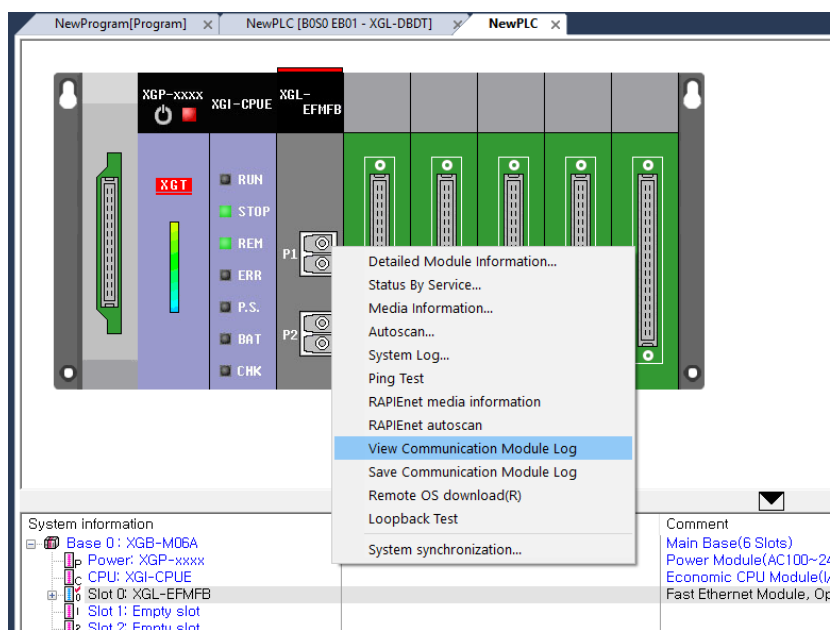

(3) Check [Event history] by selecting the upper event history in [Module log] window.

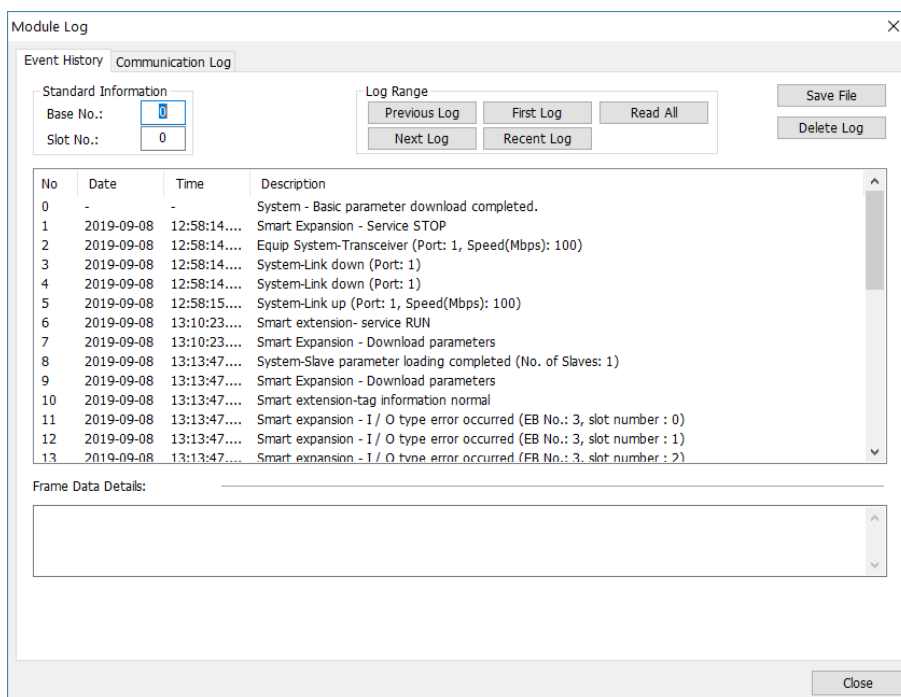

(4) Check the communication error history by selecting [Communication history] at the top of [Module log] window.

Module Log

Event History | Communication Log

Standard Information
 Base No.:
 Slot No.:

Log Range

No	Date	Time	Description
0	2019-09-08	13:04:00....	Smart Expansion - Receive EtherNet/IP Auto Scan Results (VendorID: 259, DeviceType: 12, Produ...
1	2019-09-08	13:13:30....	Smart Expansion - Receive EtherNet/IP Auto Scan Results (VendorID: 259, DeviceType: 12, Produ...
2	2019-09-08	13:13:47....	EtherNet/IP Client: Class 1 connection try (IP Address: 192.168.1.103)
3	2019-09-08	13:13:47....	EtherNet/IP Client: Class1 connection end. (IP Address: 192.168.1.103)
4	2019-09-08	13:13:52....	EtherNet/IP Client: Class 1 connection try (IP Address: 192.168.1.103)
5	2019-09-08	13:13:52....	EtherNet/IP Client: Class1 connection end. (IP Address: 192.168.1.103)

Frame Data Details:

4.4 Smart Extension Service Operation

The following explains how to operate the Smart extension service.

4.4.1 System configuration

System configuration for Smart extension service operation is as follows.

Setting item		Content		Setting program	
Master	Communication module		XGL-EFMFB		XG5000
	Base No.		0		
	Slot number		0		
	TCP/IP setting		IP address	192.168.1.100	
Subnet mask			255.255.255.0		
Gateway address			192.168.1.1		
Slave	1 stages	Station number	01	- (Station switch setting)	
	2 stages	Station number	02		
	3 stages	Station number	03		

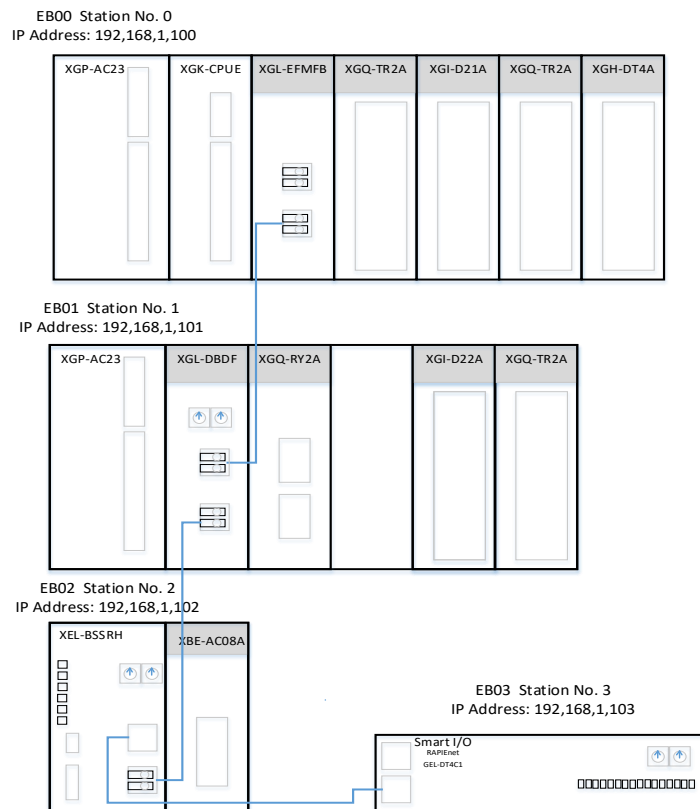

► Using the Smart extension service, the program to turn On the output contact connected to the expansion 1/3 stage

4.4.2 Sets Communication device (Slaves)

Station number or IP setting of slave module is required for Smart extension service operation.

The example sets station number to communicate with RAPIenet.

Sequence	Setting process	Setting method
1	Slave setting	1) Set the station number switch of Communication device to 01, 02, 03 by referring to the system diagram. 2) Refer to “3.4 Station No., IP Address Setting” to set the method other than the station switch.

4.4.3 Ethernet (Master) Setting

Sequence	Setting process	Setting method
2	Ethernet module (Master) registration.	1) [Project]-Open [New Project] and enter the project name, CPU series, CPU type, programming type, and program name. 2) [Project]-[Add Item]-Select [Communication module].
		3) “Add module”and select XGL-EFMB (B) and click “OK” button.

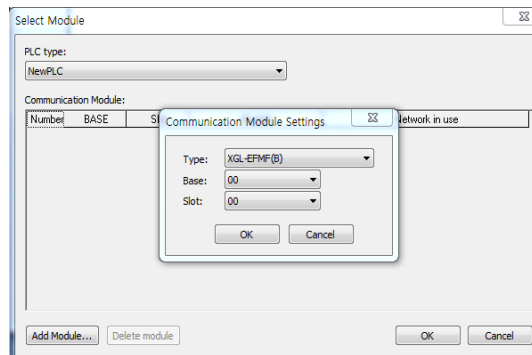
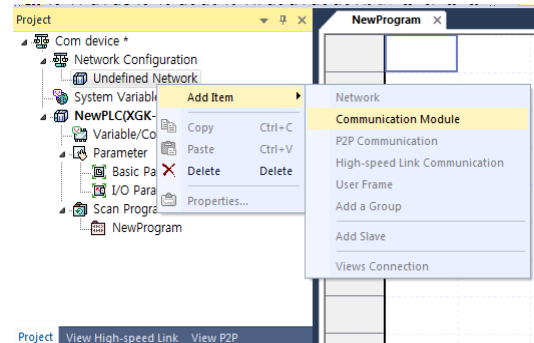
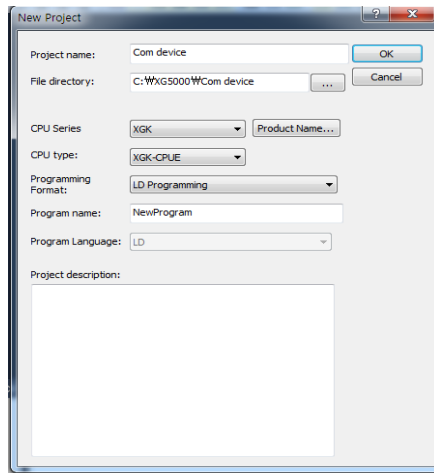

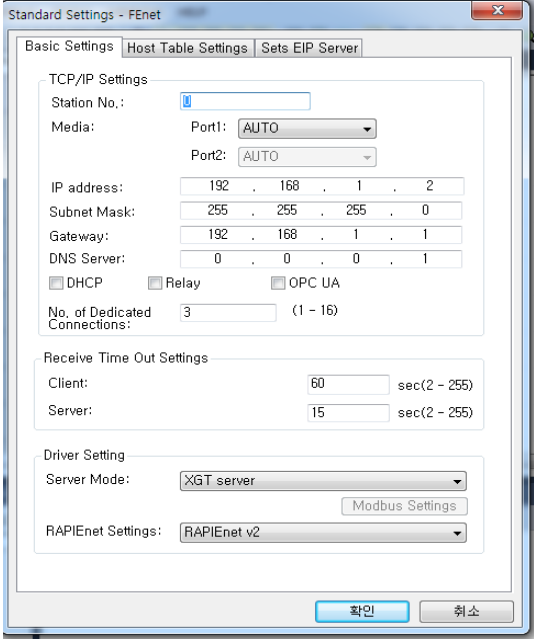
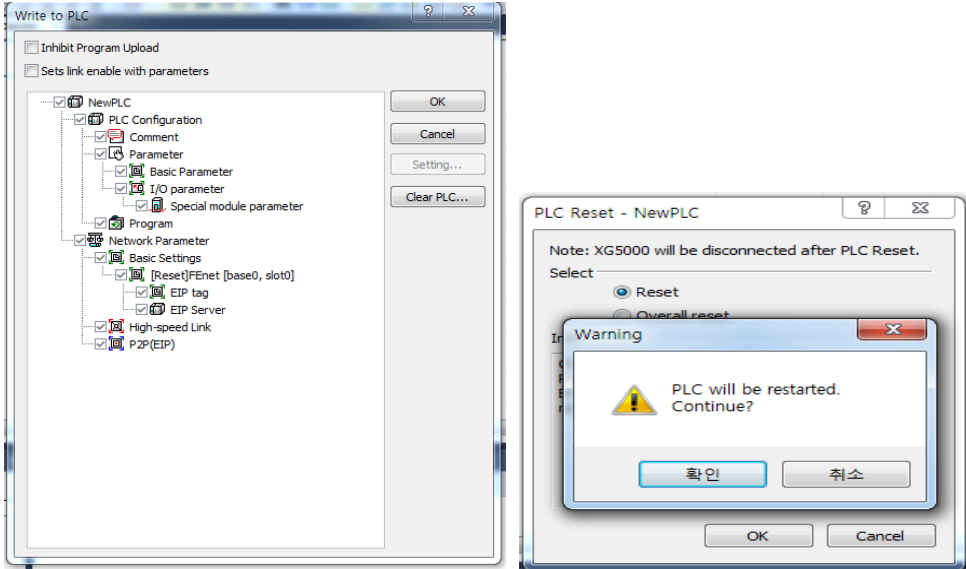
Sequence	Setting process	Setting method
3	Ethernet module basic parameter setting	<p>1) Select (double-click) the Ethernet module in the project tree and enter the following preference items.</p> 
		<p>1) Connect to the PLC and download the standard settings -FNet. 2) After write to PLC, reset PLC to apply the parameters.</p> 

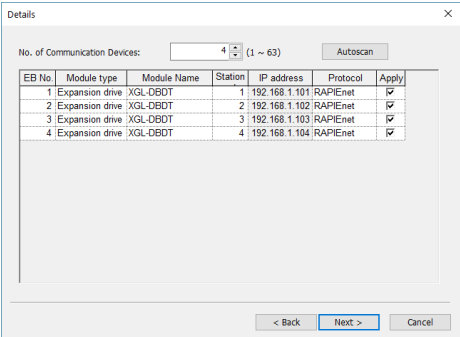
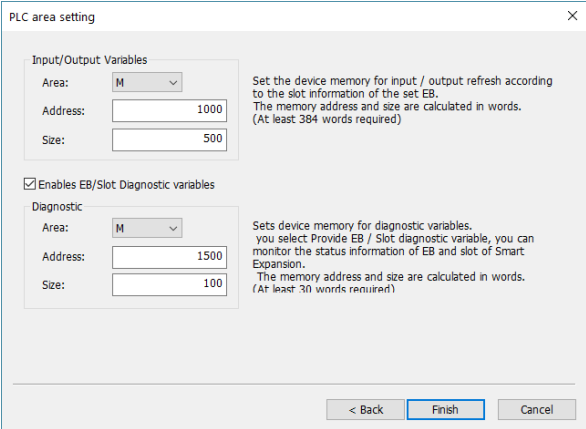
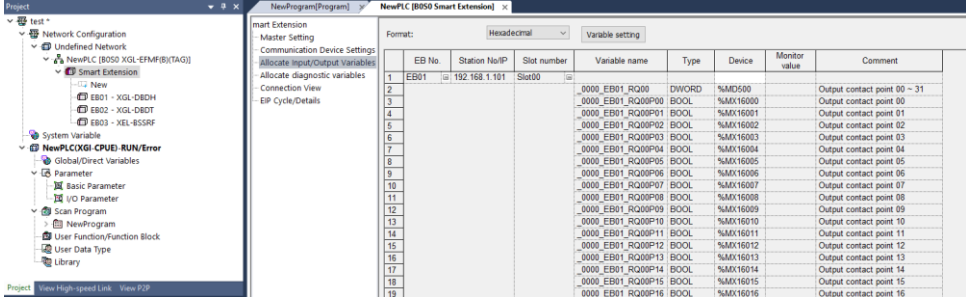
Sequence	Setting process	Setting method
4	Smart extension registration	<p>1) Connect to PLC, right-click Ethernet module in the project tree and select [Add item] → [Smart Extension].</p> <p>2) Click "Auto scan" in Smart extension wizard, and the connected device will be displayed as below.</p>  <p>1) Change the setting value to the initial value set in [PLC area setting] and click "Finish".</p> 
5	Allocate Smart extension input/output variables	<p>1) [Smart Extension] - Open [Input/output variable assignment] and click "Register variable".</p> <p>2) It can be created by referring to the program after registering the variable</p> 

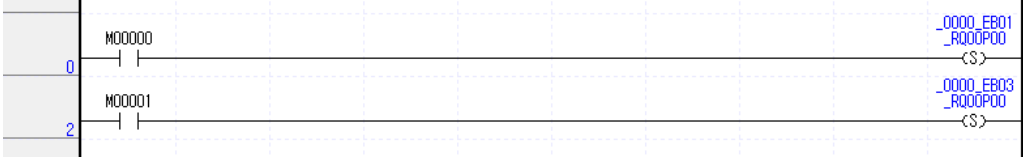
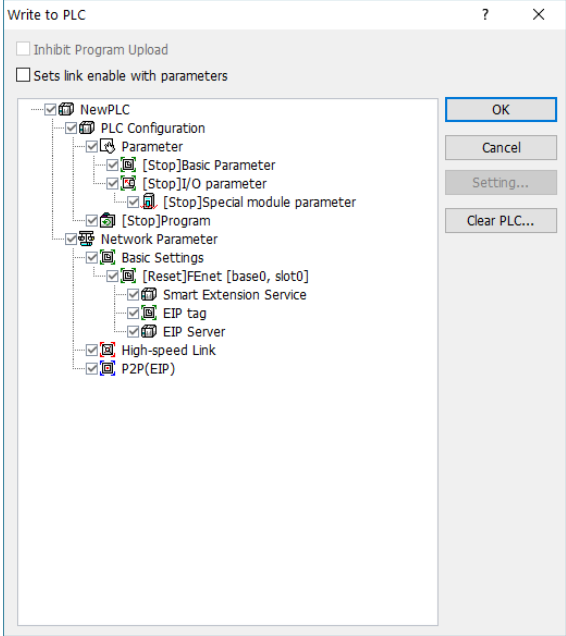
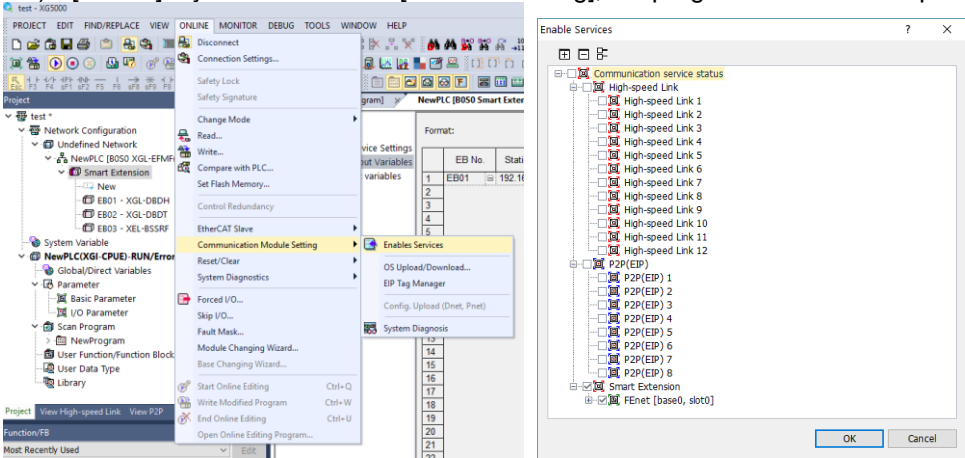
Sequence	Setting process	Setting method
6	programming	<p>1) Make the Scan program. In case of M00000 On, output contact 0 of slot 0 (XGQ-RY2A) mounted in EB01 turns on. In addition, when M00001 contact is on, output No. 0 of Smart I/O block (GEL-DT4C1) turns on.</p> 
7	Program download	<p>1) [online]-Write window Click "OK" button. Then reset the system.</p> 
8	Enable Services	<p>1) Check Smart extension in [Online] → [Communication module setting and diagnosis] -[Service enable] and click "OK" button. 2) [Online]-If you click "Run" in [Mode switching], the program in item 6 will operate.</p> 

4.5 Smart Extension System Configuration

Smart extension service can be used in various system configurations. However, if 1Gbps and 100Mbps media are mixed in the system, it will operate at 100Mbps. In case of optical media, the transceiver should be mounted accordingly.

4.5.1 Typical Configuration



Mix RAPIenet and EtherNet/IP communication for ring/line configuration.

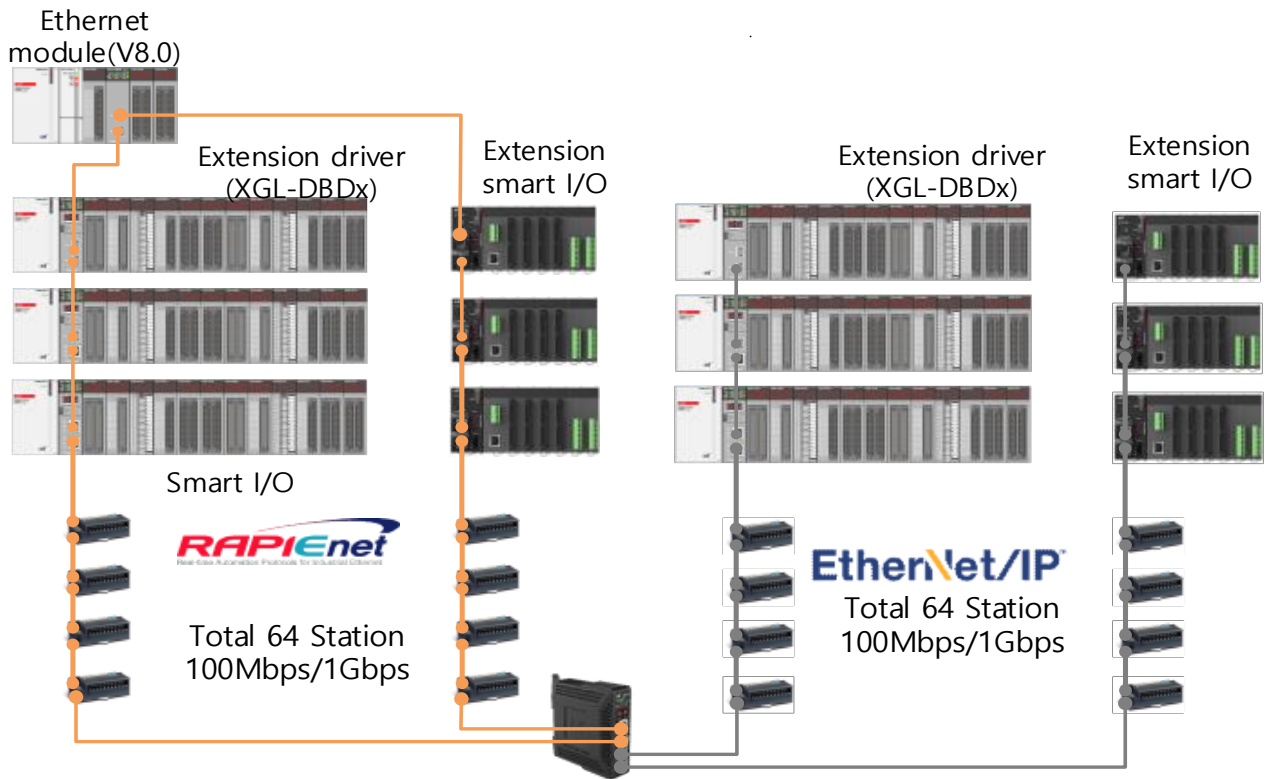

Switch module (MRS) does not support ring type connection in network configuration with only nodes that do not support RAPIEnet . That is, if there is at least one device that supports RAPIEnet other than MRS in MRS Ring, it supports ring type connection.

Notes

(1) When using the EtherNet/IP protocol in the Smart extension service, general-purpose Ethernet switch can be used. However, when using the RAPIEnet protocol, communication is not guaranteed when using the universal switch.

4.5.2 Auto Speed Sync operation

The Smart extension Master and Communication Device Modules provide an Auto Speed Sync function that automatically matches the speed of the two communication ports when the media setting of both communication ports is AUTO. At this time, the communication speed is synchronized to the lower of the communication speeds of the two ports.

When all the conditions below are met, Auto Speed Sync function is activated and the media setting information is completed until the module is reset.

- (1) The media setting on the electrical port is AUTO - Electrical / Mixed module
- (5) When the RAPIEnet setting is RAPIEnet v2, or when the RAPIEnet setting is Disable but the Relay option is Enable.
- (6) When receiving service data (data for refreshing slave I / O module data (refresh data), not setting data such as parameter data) from another company or Ethernet (master).

ex 1) When the link speed of the network is set to 100Mbps by the Auto Speed Sync function, if a node supporting all 1G / 100M is added to the network, the node is connected at 100M speed and the relay function of the neighbour node is also operated. Communication is possible

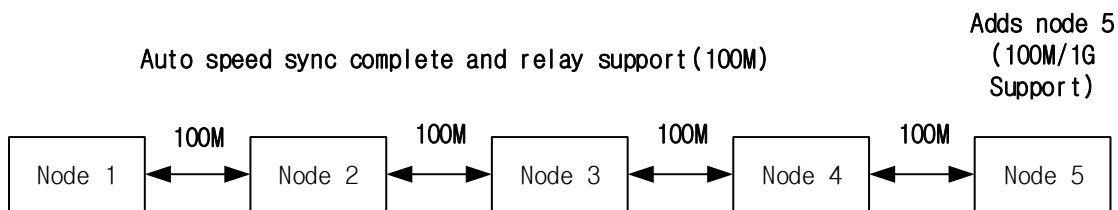

ex 2) When the network's link speed is set to 100Mbps by the Auto Speed Sync function, if a node that supports only 1G is added to the network, communication is not possible because the communication link between neighbouring nodes is not established.

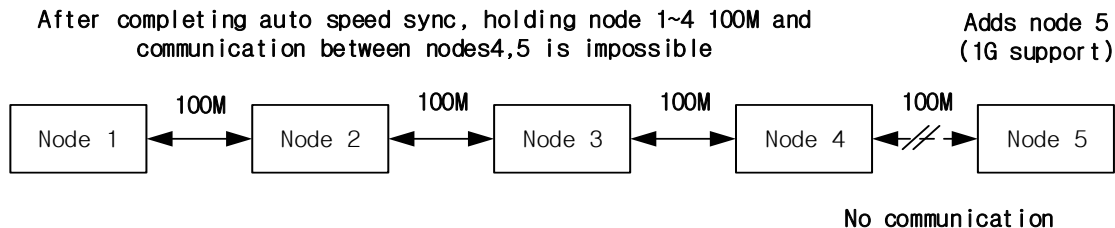

ex 3) When the link speed of the network is set to 1 Gbps by the Auto Speed Sync function, if a node that supports only 100M is added to the network, it is connected to 100M. However, since the relay function of the neighbour node does not work, communication with other nodes except the previous node is impossible.

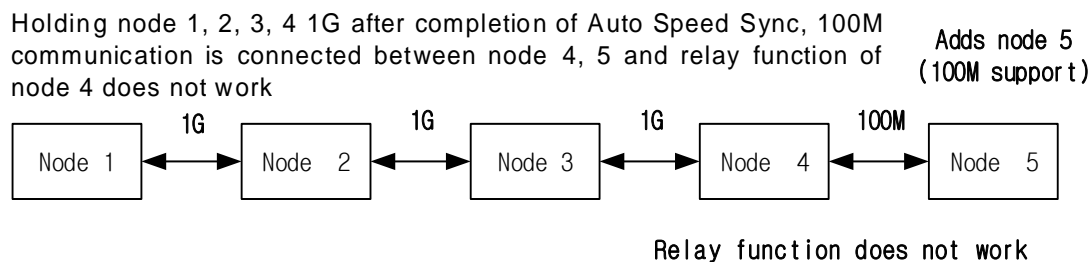

Note

- (1) The optical module determines the link speed according to the Transceiver's 100M or 1G even if the media is set to AUTO. However, in case of the mixing module, if 100M Transceiver is connected to the optical port, if the electrical port is set to AUTO, communication will be made at 100M according to the optical port speed.

Chapter 5 Server function

5.1 Overview

The communication device provides RAPIEnet, EtherNet /IP, Modbus/TCP integrated server functions. Automatically analyses the received message without user setting and generates response frame according to the protocol and sends it.

5.1.1 Assignment data by module

The data allocation method of the expansion module installed in the Communication device uses a fixed data allocation method and a variable data allocation method

(1) Fixed data allocation

The expansion module installed is allocated fixed size data regardless of module type.

Device	Device Size	Assignment data area per slot [Byte]
I (Digital input data)	8 Byte	[Slot no x 8] to [(Slot no + 1) x 8 -1]
Q (Digital output data)	8 Byte	[Slot no x 8] to [(Slot no + 1) x 8 -1]
U (Special module data)	64 byte	[Slot no x 64] to [(Slot no + 1) x 64 -1]

Notes

8 bytes of I/O data and 64 bytes of special data are allocated to the modules installed in the expansion driver/ Smart I/O expansion. Use valid data by referring to the manual. That is, in case of XGI-D22A, 8 bytes are allocated for digital input data, but only 2 bytes are input and the remaining 6 bytes are not used.

(2) Variable(Refresh) data allocation

The data size allocated depends on the type of expansion module installed. The input/output refresh area is allocated according to the available input and output data sizes among the digital input, digital output, and special module data, and the next slot is allocated following the refresh area occupied by the previous slot.

Classification	Size of assignment data
Input refresh	4Byte (Input Header) + Sum of input data sizes of mounted modules (Digital input data, special module data read areas)
Output refresh	Sum of output data sizes of mounted modules (Digital output data, special module data write areas)

1) Assignment data for each expansion module

Large category		Small category	Device Name	Input [Byte]	Output [Byte]	
Expansion drive	Digital module	Digital input module	XGI-D21A	2	0	
			XGI-D22A/B	2	0	
			XGI-D24A/B	4	0	
			XGI-D28A/B	8	0	
			XGI-A12A	2	0	
			XGI-A21A/C	2	0	
			XGI-D21D	2	0	
		Digital output module	XGQ-RY1A	0	2	
			XGQ-RY2A/B	0	2	
			XGQ-TR1C	0	2	
			XGQ-TR2A/B	0	2	
			XGQ-TR4A/B	0	4	
			XGQ-TR8A/B	0	8	
			XGQ-SS2A	0	2	
	Digital Input/output module	XGQ-RY1D	2	2		
	Special module	Analog input module	XGH-DT4A	2	2	
			XGF-AV8A	26	2	
			XGF-AC8A	26	2	
			XGF-AD4S	22	2	
			XGF-AD8A	26	2	
			XGF-AD16A	44	2	
			XGF-AC4H	22	2	
		XGF-AW4S	22	2		
		Analog output module	XGF-DV4A	4	20	
			XGF-DV8A	4	20	
			XGF-DC4A	4	20	
			XGF-DC8A	4	20	
			XGF-DV4S	4	20	
			XGF-DC4S	4	20	
			XGF-DC4H	4	20	
		Analog input/output module	XGF-AH6A	14	10	
		High Speed Counter module	XGF-HO2A	46	4	
XGF-HD2A			46	4		
XGF-HO8A			42	8		
Expansion driver		Special module	Temperature input module	XGF-RD4A	58	2
				XGF-RD4S	58	2
	XGF-TC4S			58	2	
	XGF-RD8A			44	2	
	Process control module	XGF-TC4UD	36	26		
		XGF-TC4RT	36	26		

Large category		Small category	Product Name	Input [Byte]	Output [Byte]
Smart I/O expansion	Digital module	Digital input module	XBE-DC08A	2	0
			XBE-DC16A/B	2	0
			XBE-DC32A	4	0
			XBE-AC08A	2	0
		Digital output module	XBE-TN/TP08A	0	2
			XBE-TN/TP16A	0	2
			XBE-TN/TP32A	0	4
			XBE-RY08A/B	0	2
			XBE-RY16A	0	2
			XBE-DR16A	2	2
	Digital input/output module	XBE-DN32A	2	2	
	Special module	Analog input module	XBF-AD04A	12	2
			XBF-AD08A	22	2
			XBF-AD04C	26	2
		Analog output module	XBF-DV04A	4	10
			XBF-DC04A	4	10
			XBF-DC04B	4	10
			XBF-DV04C	4	10
			XBF-DC04C	4	10
		Analog input/output module	XBF-AH04A	12	6
		RTD input	XBF-RD04A	24	0
			XBF-RD01A	24	0
		TC input	XBF-TC04B	40	2
			XBF-TC04S	40	2
load cell		XBF-LD02S	58	6	
High speed counter module		XBF-HO02A	44	4	
	XBF-HD02A	44	4		

2) Smart I/O block Data allocation size

Large category		Small category	Product Name	Input [Byte]	Output [Byte]
Smart I/O block	Digital input module	GEL-D24C	4	0	
	Digital output module	GEL-RY2C	0	2	
		GEL-TR4C/C1	0	4	
	Digital input-output module	GEL-DT4C/C1	2	2	
	Analog input module	GEL-AC8C	26	2	
		GEL-AV8C	26	2	
	Analog output module	GEL-DC4C	4	20	
		GEL-DV4C	4	20	

5.1.2 Data Allocation Example

The example system configuration below illustrates the data allocation results.

[System configuration]

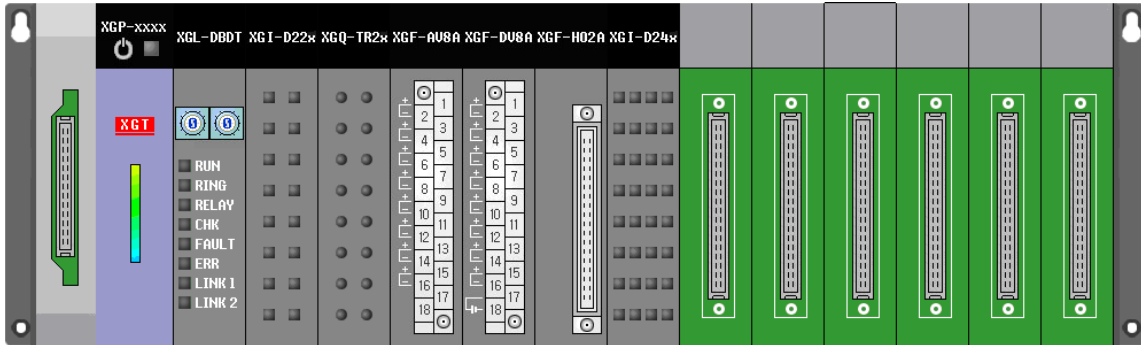

Slot number	Product Name	Description
0	XGI-D22A	DC Input 16 points
1	XGQ-TR2A	TR output 16 points
2	XGF-AV8A	Analog voltage input(8 channel)
3	XGF-DV8A	Analog voltage output(8 channel)
4	XGF-HO2A	High speed counter input(2 channel, OC)
5	XGI-D24A	DC Input 32 points

(1) Fixed data allocation

1) Fixed data allocation result

Slot number	Product Name	I	Q	U
0	XGI-D22A	IB0~IB7	QB0~QB7	UB0~UB63
1	XGQ-TR2A	IB8~IB15	QB8~QB15	UB64~UB127
2	XGF-AV8A	IB16~IB23	QB16~QB23	UB128~UB191
3	XGF-DV8A	IB24~IB31	QB24~QB31	UB192~UB255
4	XGF-HO2A	IB32~IB39	QB32~QB39	UB256~UB319
5	XGI-D24A	IB40~IB47	QB40~QB47	UB320~UB383

2) Detailed contents(Valid allocation area)

< I >

Slot number	Product Name	Address assignment	Variable type	Variable comment
0	XGI-D22A	IB0	BYTE	Input contacts 00 ~ 07
		IB1	BYTE	Input contacts 08 ~ 15
5	XGI-D24A	IB40	BYTE	Input contacts 00 ~ 07
		IB41	BYTE	Input contacts 08 ~ 15
		IB42	BYTE	Input contacts 16 ~ 23
		IB43	BYTE	Input contacts 24 ~ 31

< Q >

Slot number	Product Name	Address assignment	Variable type	Variable comment
1	XGQ-TR2A	QB8	BYTE	Output contacts 00 ~ 07
		QB9	BYTE	Output contacts 08 ~ 15

< U >

Slot number	Product Name	Address assignment	Variable type	Variable comment	R/W
2	XGF-AV8A	UB128.0	BIT	Analog input module: Module error	R
		UB129.7	BIT	Analog input module: Module ready	R
		UB130.0	BIT	Analog input module: CH0 RUN	R
		UB130.1	BIT	Analog input module: CH1 RUN	R
		UB130.2	BIT	Analog input module: CH2 RUN	R
		UB130.3	BIT	Analog input module: CH3 RUN	R
		UB130.4	BIT	Analog input module: CH4 RUN	R
		UB130.5	BIT	Analog input module: CH5 RUN	R
		UB130.6	BIT	Analog input module: CH6 RUN	R
		UB130.7	BIT	Analog input module: CH7 RUN	R
		UB132	WORD	Analog input module: CH0 conversion value	R
		UB134	WORD	Analog input module: CH1 conversion value	R
		UB136	WORD	Analog input module: CH2 conversion value	R
		UB138	WORD	Analog input module: CH3 conversion value	R
		UB140	WORD	Analog input module: CH4 conversion value	R
		UB142	WORD	Analog input module: CH5 conversion value	R
		UB144	WORD	Analog input module: CH6 conversion value	R
		UB146	WORD	Analog input module: CH7 conversion value	R
		UB148.0	BIT	Analog input module: CH0 input disconnection detection	R
		UB148.1	BIT	Analog input module: CH1 input disconnection detection	R
		UB148.2	BIT	Analog input module: CH2 input disconnection detection	R
		UB148.3	BIT	Analog input module: CH3 input disconnection detection	R
		UB148.4	BIT	Analog input module: CH4 input disconnection detection	R
		UB148.5	BIT	Analog input module: CH5 input disconnection detection	R
		UB148.6	BIT	Analog input module: CH6 input disconnection detection	R
		UB148.7	BIT	Analog input module: CH7 input disconnection detection	R
		UB150.0	BIT	Analog input module: Error clear request	W
		UB168.0	BIT	Analog input module: Channel 0 upper limit alarm	R
		UB168.1	BIT	Analog input module: Channel 1 upper limit alarm	R
		UB168.2	BIT	Analog input module: Channel 2 upper limit alarm	R
		UB168.3	BIT	Analog input module: Channel 3 upper limit alarm	R
		UB168.4	BIT	Analog input module: Channel 4 upper limit alarm	R
		UB168.5	BIT	Analog input module: Channel 5 upper limit alarm	R
		UB168.6	BIT	Analog input module: Channel 6 upper limit alarm	R
		UB168.7	BIT	Analog input module: Channel 7 upper limit alarm	R
		UB170.0	BIT	Analog input module: Channel 0 lower limit alarm	R
		UB170.1	BIT	Analog input module: Channel 1 lower limit alarm	R
		UB170.2	BIT	Analog input module: Channel 2 lower limit alarm	R
		UB170.3	BIT	Analog input module: Channel 3 lower limit alarm	R
		UB170.4	BIT	Analog input module: Channel 4 lower limit alarm	R
UB170.5	BIT	Analog input module: Channel 5 lower limit alarm	R		
UB170.6	BIT	Analog input module: Channel 6 lower limit alarm	R		
UB170.7	BIT	Analog input module: Channel 7 lower limit alarm	R		

Slot number	Product Name	Address assignment	Variable type	Variable comment	R/W
3	XGF-DV8A	UB192.0	BIT	Analog output module: Channel 0 error	R
		UB192.1	BIT	Analog output module: Channel 1 error	R
		UB192.2	BIT	Analog output module: Channel 2 error	R
		UB192.3	BIT	Analog output module: Channel 3 error	R
		UB192.4	BIT	Analog output module: Channel 4 error	R
		UB192.5	BIT	Analog output module: Channel 5 error	R
		UB192.6	BIT	Analog output module: Channel 6 error	R
		UB192.7	BIT	Analog output module: Channel 7 error	R
		UB193.7	BIT	Analog output module: Module ready	R
		UB194.0	BIT	Analog output module: CH0 RUN	R
		UB194.1	BIT	Analog output module: CH1 RUN	R
		UB194.2	BIT	Analog output module: CH2 RUN	R
		UB194.3	BIT	Analog output module: CH3 RUN	R
		UB194.4	BIT	Analog output module: CH4 RUN	R
		UB194.5	BIT	Analog output module: CH5 RUN	R
		UB194.6	BIT	Analog output module: CH6 RUN	R
		UB194.7	BIT	Analog output module: CH7 RUN	R
		UB196.0	BIT	Analog output module: Channel 0 output status setting	W
		UB196.1	BIT	Analog output module: Channel 1 output status setting	W
		UB196.2	BIT	Analog output module: Channel 2 output status setting	W
		UB196.3	BIT	Analog output module: Channel 3 output status setting	W
		UB196.4	BIT	Analog output module: Channel 4 output status setting	W
		UB196.5	BIT	Analog output module: Channel 5 output status setting	W
		UB196.6	BIT	Analog output module: Channel 6 output status setting	W
		UB196.7	BIT	Analog output module: Channel 7 output status setting	W
		UB198	WORD	Analog Output module: Channel 0 Input value	W
		UB200	WORD	Analog output module: Channel 1 Input value	W
		UB202	WORD	Analog output module: Channel 2 Input value	W
		UB204	WORD	Analog output module: Channel 3 Input value	W
		UB206	WORD	Analog Output module: Channel 4 Input value	W
UB208	WORD	Analog Output module: Channel 5 Input value	W		
UB210	WORD	Analog output module: Channel 6 Input value	W		
UB212	WORD	Analog output module: Channel 7 Input value	W		

Slot number	Product Name	Address assignment	Variable type	Variable comment	R/W
4	XGF-HO2A	UB256.0	BIT	High speed counter module: CH0 up/down counter status flag	R
		UB256.1	BIT	High speed counter module: Channel 0 external preset command detection flag	R
		UB256.3	BIT	High speed counter module: Channel 0 carry value	R
		UB256.4	BIT	High speed counter module: Channel 0 borrow value	R
		UB256.5	BIT	High speed counter module: Channel 0 auxiliary function status	R
		UB256.6	BIT	High speed counter module: Channel 0 compare output 0 status	R
		UB256.7	BIT	High speed counter module: Channel 0 compare output 1 status	R
		UB257.6	BIT	High speed counter module: Channel 0 error flag	R
		UB257.7	BIT	High speed counter module: Module ready	R
		UB258.0	BIT	High speed counter module: CH1 up/down counter status flag	R
		UB258.1	BIT	High speed counter module: Channel 1 external preset command detection flag	R
		UB258.3	BIT	High speed counter module: Channel 1 carry value	R
		UB258.4	BIT	High speed counter module: Channel 1 borrow value	R
		UB258.5	BIT	High speed counter module: Channel 1 auxiliary function status	R
		UB258.6	BIT	High speed counter module: Channel 1 compare output 0 status	R
		UB258.7	BIT	High speed counter module: Channel 1 compare output 1 status	R
		UB259.6	BIT	High speed counter module: Channel 1 error flag	R
		UB260	WORD	High speed counter module: Channel 0 count value (LWORD)	R
		UB262	WORD	High speed counter module: Channel 0 count value (HWORD)	R
		UB264	WORD	High speed counter module: Channel 0 latch count value (LWORD)	R
		UB266	WORD	High speed counter module: Channel 0 latch count value (HWORD)	R
		UB268	WORD	High speed counter module: Channel 0 sampling count value (LWORD)	R
		UB270	WORD	High speed counter module: Channel 0 sampling count value (HWORD)	R
		UB272	WORD	High speed counter module: Channel 0 input frequency value (LWORD)	R
		UB274	WORD	High speed counter module: Channel 0 input frequency value (HWORD)	R
		UB276	WORD	High speed counter module: Channel 0 Rev./unit time value (LWORD)	R
		UB278	WORD	High speed counter module: Channel 0 Rev./unit time value (HWORD)	R
		UB280	WORD	High speed counter module: Channel 1 count value (LWORD)	R
UB282	WORD	High speed counter module: Channel 1 count value (HWORD)	R		
UB284	WORD	High speed counter module: Channel 1 latch count value (LWORD)	R		
UB286	WORD	High speed counter module: Channel 1 latch count value (HWORD)	R		
UB288	WORD	High speed counter module: Channel 1 sampling count value (LWORD)	R		
UB290	WORD	High speed counter module: Channel 1 sampling count value (HWORD)	R		

		UB292	WORD	High speed counter module: Channel 1 input frequency value (LWORD)	R
		UB294	WORD	High speed counter module: Channel 1 input frequency value (HWORD)	R
		UB296	WORD	High speed counter module: Channel 1 Rev./unit time value (LWORD)	R
		UB298	WORD	High speed counter module: Channel 1 Rev./unit time value (HWORD)	R
		UB302.0	BIT	High speed counter module: Channel 0 enable counter command(level)	W
		UB302.1	BIT	High speed counter module: Channel 0 enable preset command(Edge)	W
		UB302.2	BIT	High speed counter module: Channel 0 up/down counter select command(Level)	W
		UB302.3	BIT	High speed counter module: Channel 0 auxiliary function request(Edge, Level)	W
		UB302.4	BIT	High speed counter module: Channel 0 compare function enable command(Level)	W
		UB302.5	BIT	High speed counter module: Channel 0 compare output signal enable command(Level)	W
		UB302.6	BIT	High speed counter module: Channel 0 compare output 0 equal reset command (Edge)	W
		UB302.7	BIT	High speed counter module: Channel 0 compare output 1 equal reset command (Edge)	W
		UB303.2	BIT	High speed counter module: CH0 carry/borrow reset command(Edge)	W
		UB303.3	BIT	High speed counter module: Channel 0 preset Ext. Input enable command	W
		UB303.4	BIT	High speed counter module: Channel 0 auxiliary function Ext. input enable command	W
		UB303.5	BIT	High speed counter module: Channel 0 Ext. Input preset reset command	W
		UB304.0	BIT	High speed counter module: Channel 1 enable counter command(level)	W
		UB304.1	BIT	High speed counter module: Channel 1 enable preset command(Edge)	W
		UB304.2	BIT	High speed counter module: Channel 1 up/down counter select command(Level)	W
		UB304.3	BIT	High speed counter module: Channel 1 auxiliary function enable command(Edge, Level)	W
		UB304.4	BIT	High speed counter module: Channel 1 compare function enable command(Level)	W
		UB304.5	BIT	High speed counter module: Channel 1 compare output signal enable command(Level)	W
		UB304.6	BIT	High speed counter module: Channel 0 compare output 0 equal reset command (Edge)	W
		UB304.7	BIT	High speed counter module: Channel 1 compare output 1 equal reset command (Edge)	W

		UB305.2	BIT	High speed counter module: Channel 1 carry/borrow reset command(Edge)	W
		UB305.3	BIT	High speed counter module: Channel 1 preset Ext. Input enable command	W
		UB305.4	BIT	High speed counter module: Channel 1 auxiliary Ext. Input enable command	W
		UB305.5	BIT	High speed counter module: Channel 1 Ext. Input preset reset command	W

(2) Variable(Refresh) data allocation

1) Variable(refresh) data allocation result

Slot number	Product Name	Input size [Byte]	Output size [Byte]	Input Refresh [Byte offset]	Output Refresh [Byte offset]
-	Input Header	4	0	0~3	-
0	XGI-D22A	2	0	4~5	-
1	XGQ-TR2A	0	2	-	0~1
2	XGF-AV8A	26	2	6~31	2~3
3	XGF-DV8A	4	20	32~35	4~23
4	XGF-HO2A	46	4	36~81	24~27
5	XGI-D24A	4	0	82~85	-
-	Totals	86	28	-	-

The first 4 bytes (input header) of the input refresh area are the LED status information. For the LED status information, refer to Appendix A.4.

2) Detailed contents

< Input Refresh >

Slot number	Product Name	BYTE offset	Variable type	Variable comment
-	-	0~3	BYTE	Input Header
0	XGI-D22A	4~5	WORD	Input contacts 00 ~ 15
2	XGF-AV8A	6.0	BIT	Analog input module: Module error
		7.7	BIT	Analog input module: Module ready
		8.0	BIT	Analog input module: CH0 RUN
		8.1	BIT	Analog input module: CH1 RUN
		8.2	BIT	Analog input module: CH2 RUN
		8.3	BIT	Analog input module: CH3 RUN
		8.4	BIT	Analog input module: CH4 RUN
		8.5	BIT	Analog input module: CH5 RUN
		8.6	BIT	Analog input module: CH6 RUN
		8.7	BIT	Analog input module: CH7 RUN
		10~11	WORD	Analog input module: CH0 conversion value
		12~13	WORD	Analog input module: CH1 conversion value
		14~15	WORD	Analog input module: CH2 conversion value
		16~17	WORD	Analog input module: CH3 conversion value
		18~19	WORD	Analog input module: CH4 conversion value
		20~21	WORD	Analog input module: CH5 conversion value
		22~23	WORD	Analog input module: CH6 conversion value
		24~25	WORD	Analog input module: CH7 conversion value
		26.0	BIT	Analog input module: CH0 input disconnection detection
		26.1	BIT	Analog input module: CH1 input disconnection detection
		26.2	BIT	Analog input module: CH2 input disconnection detection
		26.3	BIT	Analog input module: CH3 input disconnection detection
		26.4	BIT	Analog input module: CH4 input disconnection detection
		26.5	BIT	Analog input module: CH5 input disconnection detection
		26.6	BIT	Analog input module: CH6 input disconnection detection
		26.7	BIT	Analog input module: CH7 input disconnection detection
		28.0	BIT	Analog input module: Channel 0 upper limit alarm
		28.1	BIT	Analog input module: Channel 1 upper limit alarm
		28.2	BIT	Analog input module: Channel 2 upper limit alarm
		28.3	BIT	Analog input module: Channel 3 upper limit alarm
		28.4	BIT	Analog input module: Channel 4 upper limit alarm
		28.5	BIT	Analog input module: Channel 5 upper limit alarm
28.6	BIT	Analog input module: Channel 6 upper limit alarm		
28.7	BIT	Analog input module: Channel 7 upper limit alarm		
30.0	BIT	Analog input module: Channel 0 lower limit alarm		
30.1	BIT	Analog input module: Channel 1 lower limit alarm		
30.2	BIT	Analog input module: Channel 2 lower limit alarm		
30.3	BIT	Analog input module: Channel 3 lower limit alarm		
30.4	BIT	Analog input module: Channel 4 lower limit alarm		
30.5	BIT	Analog input module: Channel 5 lower limit alarm		
30.6	BIT	Analog input module: Channel 6 lower limit alarm		
30.7	BIT	Analog input module: Channel 7 lower limit alarm		

Slot number	Product Name	BYTE offset	Variable type	Variable comment
3	XGF-DV8A	32.0	BIT	Analog output module: Channel 0 error
		32.1	BIT	Analog output module: Channel 1 error
		32.2	BIT	Analog output module: Channel 2 error
		32.3	BIT	Analog output module: Channel 3 error
		32.4	BIT	Analog output module: Channel 4 error
		32.5	BIT	Analog output module: Channel 5 error
		32.6	BIT	Analog output module: Channel 6 error
		32.7	BIT	Analog output module: Channel 7 error
		33.7	BIT	Analog output module: Module ready
		34.0	BIT	Analog output module: CH0 RUN
		34.1	BIT	Analog output module: CH1 RUN
		34.2	BIT	Analog output module: CH2 RUN
		34.3	BIT	Analog output module: CH3 RUN
		34.4	BIT	Analog output module: CH4 RUN
		34.5	BIT	Analog output module: CH5 RUN
		34.6	BIT	Analog output module: CH6 RUN
		34.7	BIT	Analog output module: CH7 RUN
4	XGF-HO2A	36.0	BIT	High speed counter module: CH0 up/down counter status flag
		36.1	BIT	High speed counter module: Channel 0 external preset command detection flag
		36.3	BIT	High speed counter module: Channel 0 carry value
		36.4	BIT	High speed counter module: Channel 0 borrow value
		36.5	BIT	High speed counter module: Channel 0 auxiliary function status
		36.6	BIT	High speed counter module: Channel 0 compare output 0 status
		36.7	BIT	High speed counter module: Channel 0 compare output 1 status
		37.6	BIT	High speed counter module: Channel 0 error flag
		37.7	BIT	High speed counter module: Module ready
		38.0	BIT	High speed counter module: CH1 up/down counter status flag
		38.1	BIT	High speed counter module: Channel 1 external preset command detection flag
		38.3	BIT	High speed counter module: Channel 1 carry value
		38.4	BIT	High speed counter module: Channel 1 borrow value
		38.5	BIT	High speed counter module: Channel 1 auxiliary function status
		38.6	BIT	High speed counter module: Channel 1 compare output 0 status
		38.7	BIT	High speed counter module: Channel 1 compare output 1 status
		39.6	BIT	High speed counter module: Channel 1 error flag
		40~41	WORD	High speed counter module: Channel 0 count value (LWORD)
		42~43	WORD	High speed counter module: Channel 0 count value (HWORD)
		44~45	WORD	High speed counter module: Channel 0 latch count value (LWORD)
		46~47	WORD	High speed counter module: Channel 0 latch count value (HWORD)
		48~49	WORD	High speed counter module: Channel 0 sampling count value (LWORD)
		50~51	WORD	High speed counter module: Channel 0 sampling count value (HWORD)
52~53	WORD	High speed counter module: Channel 0 input frequency value (LWORD)		

		54~55	WORD	High speed counter module: Channel 0 input frequency value (HWORD)
		56~57	WORD	High speed counter module: Channel 0 Rev./unit time value (LWORD)
		58~59	WORD	High speed counter module: Channel 0 Rev./unit time value (HWORD)
		60~61	WORD	High speed counter module: Channel 1 count value (LWORD)
		62~63	WORD	High speed counter module: Channel 1 count value (HWORD)
		64~65	WORD	High speed counter module: Channel 1 latch count value (LWORD)
		66~67	WORD	High speed counter module: Channel 1 latch count value (HWORD)
		68~69	WORD	High speed counter module: Channel 1 sampling count value (LWORD)
		70~71	WORD	High speed counter module: Channel 1 sampling count value (HWORD)
		72~73	WORD	High speed counter module: Channel 1 input frequency value (LWORD)
		74~75	WORD	High speed counter module: Channel 1 input frequency value (HWORD)
		76~77	WORD	High speed counter module: Channel 1 Rev./unit time value (LWORD)
		78~79	WORD	High speed counter module: Channel 1 Rev./unit time value (HWORD)
		80~81	WORD	Reserved
5	XGI-D24A	82~83	WORD	Input contacts 00 ~ 15
		84~85	WORD	Input contacts 16 ~ 31

< Output Refresh >

Slot number	Product Name	BYTE offset	Variable type	Variable comment
1	XGQ-TR2A	0~1	WORD	Output contacts 00 ~ 15
2	XGF-AV8A	2.0	BIT	Analog input module: Error clear request
3	XGF-DV8A	4.0	BIT	Analog output module: Channel 0 output status setting
		4.1	BIT	Analog output module: Channel 1 output status setting
		4.2	BIT	Analog output module: Channel 2 output status setting
		4.3	BIT	Analog output module: Channel 3 output status setting
		4.4	BIT	Analog Output module: Channel 4 output status setting
		4.5	BIT	Analog output module: Channel 5 output status setting
		4.6	BIT	Analog output module: Channel 6 output status setting
		4.7	BIT	Analog output module: Channel 7 output status setting
		6~7	WORD	Analog output module: Channel 0 Input value
		8~9	WORD	Analog output module: Channel 1 Input value
		10~11	WORD	Analog output module: Channel 2 Input value
		12~13	WORD	Analog output module: Channel 3 Input value
		14~15	WORD	Analog output module: Channel 4 Input value
		16~17	WORD	Analog Output module: Channel 5 Input value
		18~19	WORD	Analog output module: Channel 6 Input value
20~21	WORD	Analog output module: Channel 7 Input value		
22~23	WORD	Reserved		

4	XGF-HO2A	24.0	BIT	High speed counter module: Channel 0 enable counter command(level)
		24.1	BIT	High speed counter module: Channel 0 enable preset command(Edge)
		24.2	BIT	High speed counter module: Channel 0 up/down counter select command(Level)
		24.3	BIT	High speed counter module: Channel 0 auxiliary function request(Edge, Level)
		24.4	BIT	High speed counter module: Channel 0 compare function enable command(Level)
		24.5	BIT	High speed counter module: Channel 0 compare output signal enable command(Level)
		24.6	BIT	High speed counter module: Channel 0 compare output 0 equal reset command (Edge)
		24.7	BIT	High speed counter module: Channel 0 compare output 1 equal reset command (Edge)
		25.2	BIT	High speed counter module: Channel 0 carry/borrow reset command(Edge)
		25.3	BIT	High speed counter module: Channel 0 preset Ext. Input enable command
		25.4	BIT	High speed counter module: Channel 0 auxiliary function Ext. input enable command
		25.5	BIT	High speed counter module: Channel 0 Ext. Input preset reset command
		26.0	BIT	High speed counter module: Channel 1 enable counter command(level)
		26.1	BIT	High speed counter module: Channel 1 enable preset command(Edge)
		26.2	BIT	High speed counter module: Channel 1 up/down counter select command(Level)
		26.3	BIT	High speed counter module: Channel 1 auxiliary function enable command(Edge, Level)
		26.4	BIT	High speed counter module: Channel 1 compare function enable command(Level)
		26.5	BIT	High speed counter module: Channel 1 compare output signal enable command(Level)
		26.6	BIT	High speed counter module: Channel 0 compare output 0 equal reset command (Edge)
		26.7	BIT	High speed counter module: Channel 1 compare output 1 equal reset command (Edge)
		27.2	BIT	High speed counter module: Channel 1 carry/borrow reset command(Edge)
		27.3	BIT	High speed counter module: Channel 1 preset Ext. Input enable command
		27.4	BIT	High speed counter module: Channel 1 auxiliary Ext. Input enable command
27.5	BIT	High speed counter module: Channel 1 Ext. Input preset reset command		

5.2 RAPIEnet Server function

5.2.1 Overview

(1) RAPIEnet Features

- Supports the IEEE 802.3 standard.
- It can be configured with 64 stations including maximum master module.
- Supports ring and line (daisy chain) topology to configure the network in the field and supports dual function in ring topology configuration.
- Provides station number conflict alarm function.
- Provides cable distance measurement when using electric cable.
- IP setting is not necessary, and module setting can be done simply by setting station number.

5.2.2 Data display type

The RAPIEnet server function supports fixed data allocation.

(1) Format: % [position prefix] [size prefix] n1.n2.n3

Classification	Prefix	Meaning
Position	I	Input data
	Q	Output data
	U	Special module data
Size	X	1 bit
	B	1 Byte(8 Bits)
	W	1 Word(16 Bits)
	D	1 Double word(32 Bits)
	L	1 Long word(64 Bits)
n1.n2.n3	n1	Base number (starting from 0)
	n2	Slot number (starting from 0)
	n3	The n3th data (starting with 0) according to [size prefix]

(2) Example of data setting

The description is based on the system in the Data Allocation Example.

Slot number	Product Name	I	Q	U
0	XGI-D22A	%IW0.0.0	-	-
1	XGQ-TR2A	-	%QW0.1.0	-
2	XGF-AV8A	-	-	%UW0.2.0~%UW0.2.11 %UW0.2.20~%UW0.2.21
3	XGF-DV8A	-	-	%UW0.3.0~%UW0.3.11
4	XGF-HO2A	-	-	%UW0.4.0~%UW0.4.24
5	XGI-D24A	%IW0.5.0~%IW0.5.1	-	-

5.2.3 Diagnosis data display type

(1) Data allocation

Device area	Content	Device Size
F	System flag	2,048 byte

(2) Format:% [position prefix] [size prefix] n1

Classification	Prefix	Meaning
Position	F	System flag
Size	X	1 bit
	B	1 Byte(8 Bits)
	W	1 Word(16 Bits)
	D	1 Double word(32 Bits)
	L	1 Long word(64 Bits)
n1	n1	Offset (starting with 0) according to [size prefix]

Notes

For the meaning of each data of system flag, refer to Appendix A.2.1 Special Relay (F) List.

5.2.4 Server operation

(1) System configuration

Describes system configuration and parameter setting for RAPIEnet service operation.

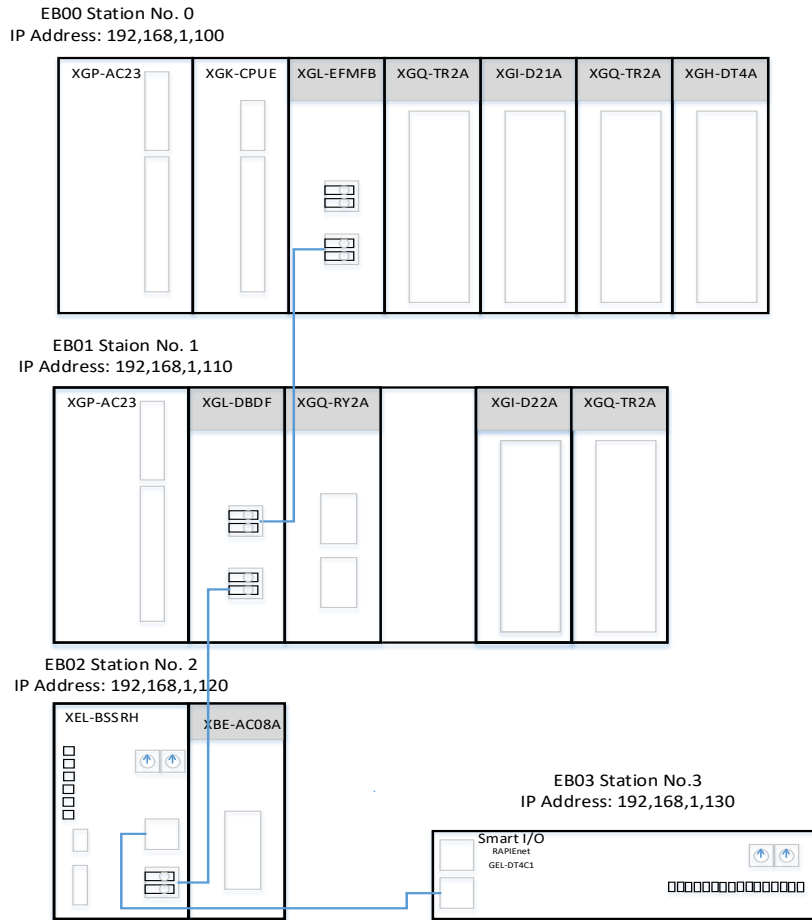

Setting item		Content		Setting program		
Ethernet module (Master)	Master Setting		XGL-EFMFB		XG5000	
	Base No.		0			
	Slot number		0			
	Station number		0			
	TCP/IP setting		IP Address	192.168.1.100		
			Subnet Mask	255.255.255.0		
			Gateway Address	192.168.1.1		
	P2P channel setting		RAPIEnet client			
	P2P start condition		_T100MS			
P2P method		Continuous				
Data type		Byte				
Communication Device (Server)	1 stages	Module parameter settings		IP Address	192.168.1.110	XG5000
				Subnet Mask	255.255.255.0	
				Gateway Address	192.168.1.1	
				Station number	1	
		Read area		Device	%IB0.0.0	
		Save area		Device	D00100	
Size	8					

	2 stages	Module parameter settings	IP Address	192.168.1.120	XG5000
			Subnet Mask	255.255.255.0	
			Gateway Address	192.168.1.1	
			Station number	2	
		Read area	Device	D00200	
	Save area	Device	%IB0.0.0		
	Size			8	
	3 stages	Module parameter settings	IP Address	192.168.1.130	XG5000
			Subnet Mask	255.255.255.0	
			Gateway Address	192.168.1.1	
Station number			3		
Read area		Device	D00200		
Save area		Device	%QB0.0.0		
Size			8		

(2) Slaver setting

1) Basic parameter setting

Use XG5000 to set the basic parameters of the server as shown in the table of system configuration.

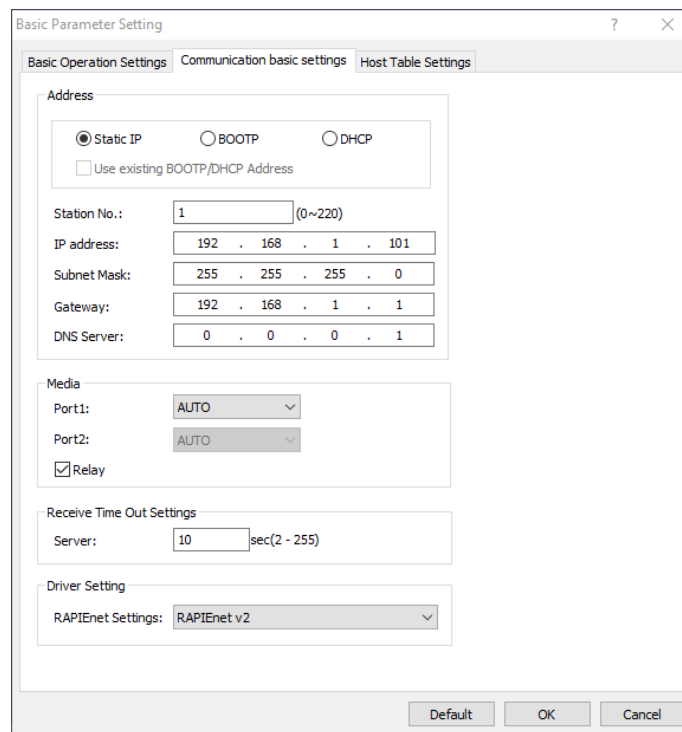

2) I/O Parameter Setting

Execute I/O synchronization in [XG5000] - [Online] - [Diagnostics] - [I/O Information] window.

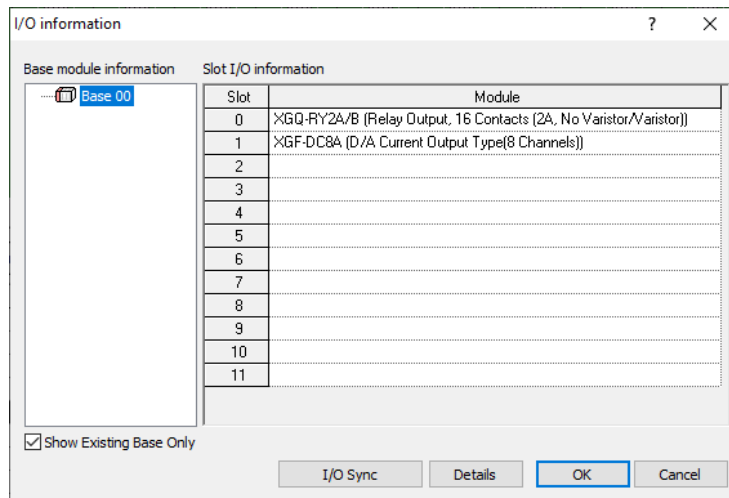

3) Parameter download

After setting the P2P parameters, download the parameters to the PLC CPU and start the P2P service. After selecting [Online]-> [Write] in XG5000 menu window, select basic setting, P2P parameter and press OK to complete parameter download.

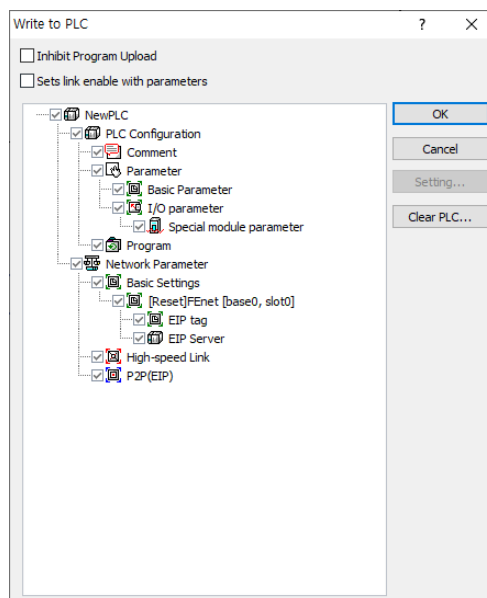

4) Enable service [XG5000] → [Online] → [Communication module setting] → [Service enable] enable P2P service set in Modbus / TCP.

(3) Ethernet module(Master) setting

This example is based on using XGL-EFMM (B) for RAPIenet service operation as a client module.

[Basic parameter setting]

Use XG5000 to set the basic parameters of the slave as shown in the table of system configuration. Refer to Ethernet User's Manual for detailed setting method.

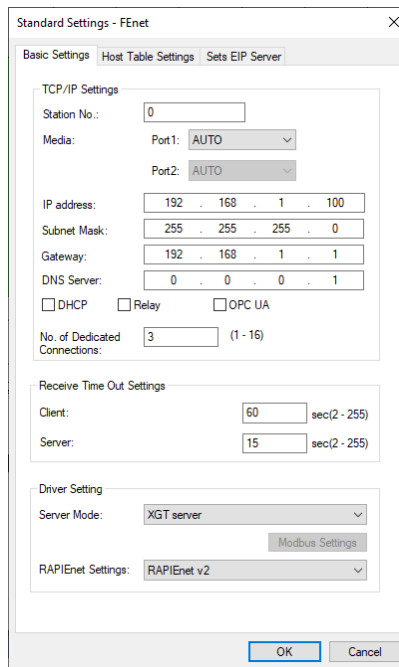

1) [P2P setting]

After adding P2P communication, set P2P channel and P2P block parameters.

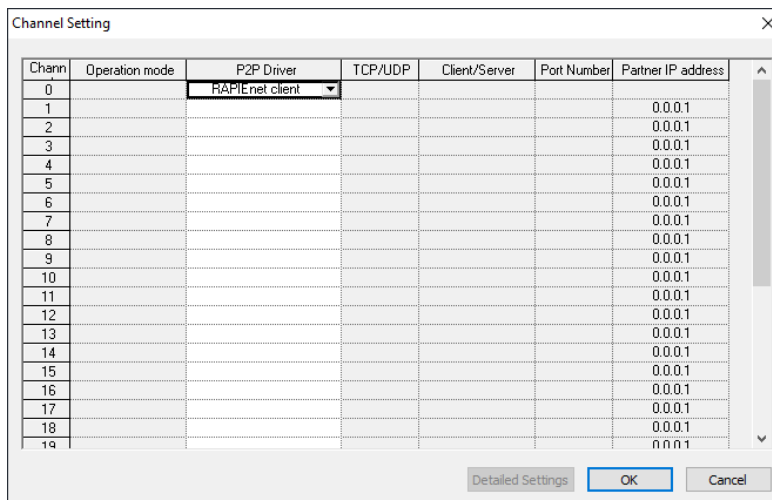
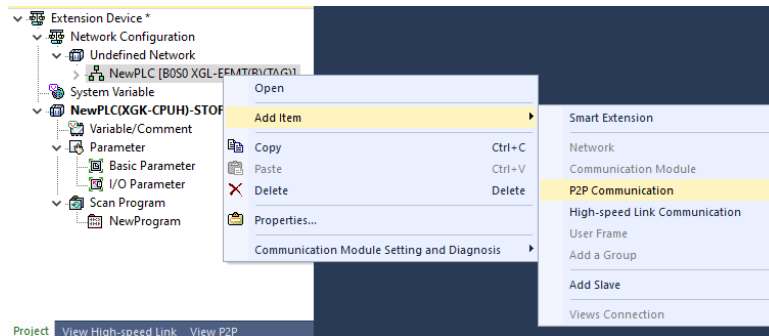

2) P2P block setting

Set the relative PLC detail setting, read area and storage area in the variable setting of the Expansion driver.

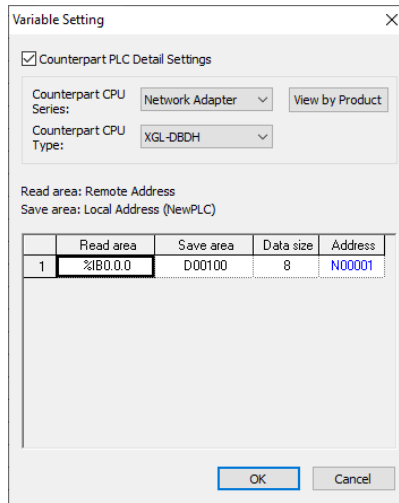

Set the relative PLC detail setting, read area and storage area in the variable setting of the Smart I/O expansion.

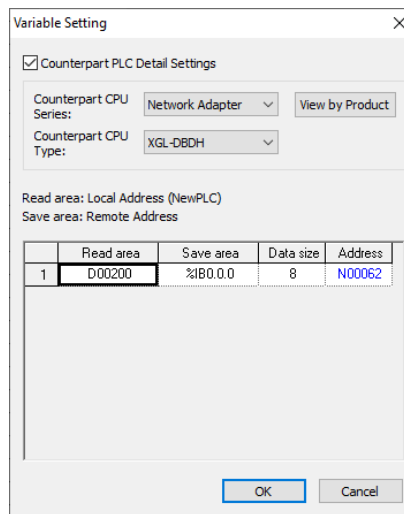

Set the relative PLC detail setting, read area and storage area in the variable setting of the Smart I/O block.

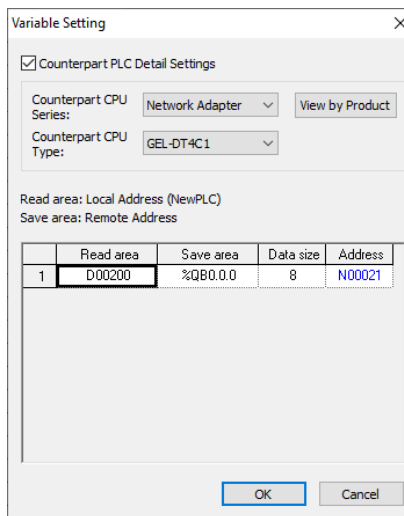

Item	Content
Counterpart CPU series	Select the counterpart CPU series to connect to.

Counterpart PLC detail settings	Counterpart CPU type	Selects the detailed CPU, communication module type.
	View by product	It is linked to the related user's manual.
P2P read	Read area	Setting the data area of the communication device to read.
	Save area	Read device area of communication device and save it to device area of Ethernet (client).
Write P2P	Read area	Specifies the device area of the CPU module on which the Ethernet (client) is mounted.
	Save area	Save data of Ethernet (client) to device area of communication device.
Data size		Enter the size of data to read and storage area.
Address		This is the parameter area automatically assigned according to the P2P number. It is filled with the station number, read area, storage area, size, etc. entered by the user.

Complete the P2P block input as shown below.

Index	E-mail	Ch	Driver Setting	Header	P2P function	Conditional flag	Command type	Data Type	No. of variables	Data size	Destination station	Destination station number	Frame	Setting	Variable setting contents
0		0	RAPiEnet client		READ	_T100MS		BYTE	1		<input checked="" type="checkbox"/>	1		Setting	Number:1, Destination Station Number: XGL-DBDH READ1:%IB0.0.0.SAVE1:D00100.SIZE1:8
1		0	RAPiEnet client		WRITE	_T100MS		BYTE	1		<input checked="" type="checkbox"/>	2		Setting	Number:1, Destination Station Number: GEL-TR4C1 READ1:0.00200.SAVE1:%QB0.0.0.SIZE1:8
2		0	RAPiEnet client		WRITE	_T100MS		BYTE	1		<input checked="" type="checkbox"/>	3		Setting	Number:1, Destination Station Number: GEL-DT4C1 READ1:0.00200.SAVE1:%QB0.0.0.SIZE1:8

Notes

(1) If the communication device is not set in the details area of the external PLC, normal data transmission/reception will not be performed.

3) Downloading parameter

When the P2P parameter setting is completed, you need to download the parameters to the PLC CPU and start the P2P service. After selecting [Online]-> [Write] in XG5000 menu window, select basic setting, P2P parameter and press OK to complete parameter download.

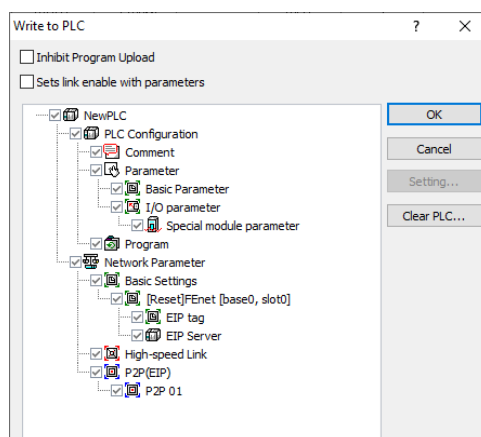

4) Enable services

Enable P2P service with Modbus/TCP set via [XG5000] - [Online] - [Communication module setting] - [Service enable].

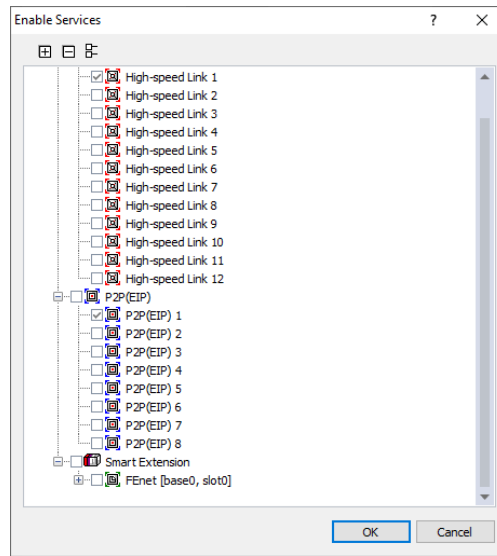

5.2.5 Check service operation

[System diagnostic information check]

Check through the P2P service in the service status of [XG5000] - [Online] - [Communication module setting] - [System Diagnosis].

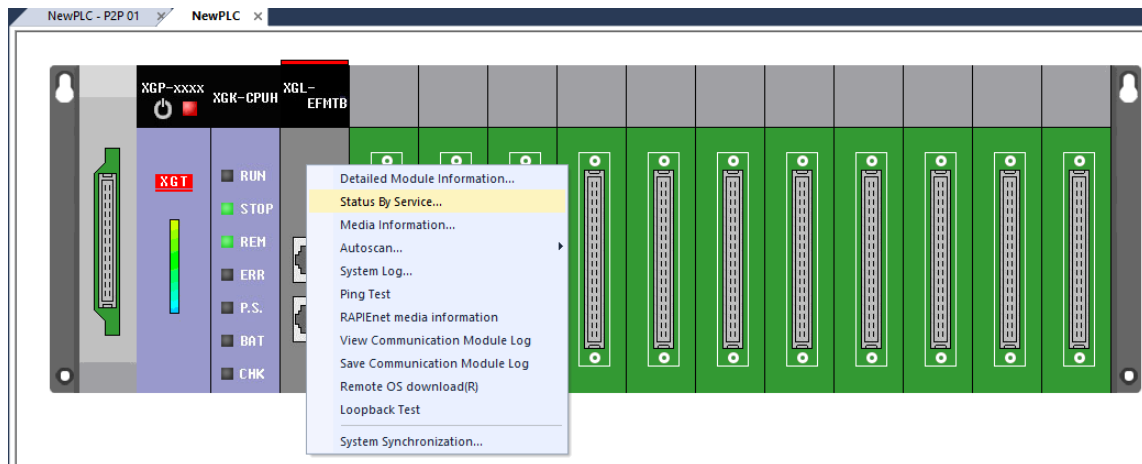

In the [Status by Service] window, you can confirm that the P2P service works normally.

Status by service

Dedicated Service P2P Service HS Link Service Smart Extension

Standard Information

Base No.:

Slot No.:

Service information

Parameter existence: Block in services:

Parameter task status:

Communication Diagnostics

Block number	Channel number	Connection Status	Packets per second	Service count	Error count	Block status
0	0	CONNECT	5	458	0	OK(0x0000)
1	0	CONNECT	5	458	0	OK(0x0000)
2	0	CONNECT	5	458	0	OK(0x0000)

Details:

5.3 EtherNet /IP server functions

5.3.1 Overview

EtherNet/IP is a protocol that puts Common Industrial Protocol (CIP: Common Industrial Protocol such as DeviceNet, ControlNet, CompoNet, etc.) to the upper layer to the open protocol Ethernet. EtherNet /IP therefore enables DeviceNet, ControlNet, and CompoNet product developers, system integrators and users to apply the same objects and profiles to ensure interoperability between multi-vendor and sub-network devices.

Communication devices provide EtherNet/IP protocol server services.

(1) EtherNet/IP Operation

EtherNet/IP communication methods can be divided into implicit communication method and explicit communication method, and they are divided into client and server functions respectively. Communication devices provide implicit cycle communication server and explicit non-cycle communication server function.

- Cycle Communication (Implicit)

The implication of the Implicit Message in the periodic communication is implicit message, meaning that the header contains the least information except the corresponding data on the frame, meaning that the frame itself does not know the meaning of the data. Therefore, the header information is simple, so the frame can be processed quickly to process the data. EtherNet/IP establishes a connection between the client and the server with parameters for this data transfer. The client requests the connection and receives the requested data. The server receives the request and transmits the data to the requested packet interval (RPI) according to the desired method (Unicast/Multicast). It's possible. Therefore, the Client will set the Consumed Tag and the Server will set the Produced Tag

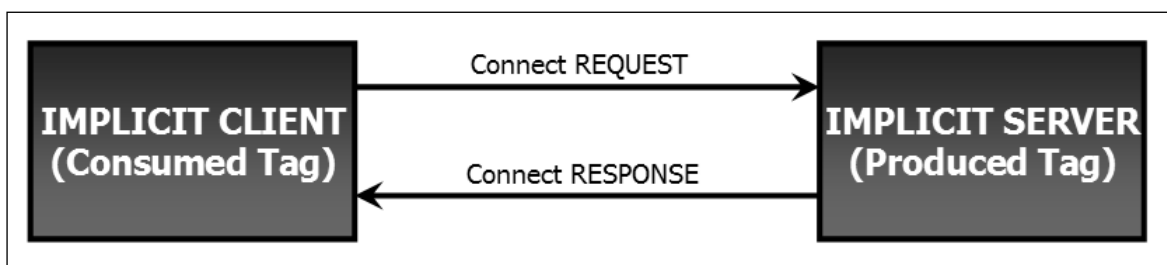

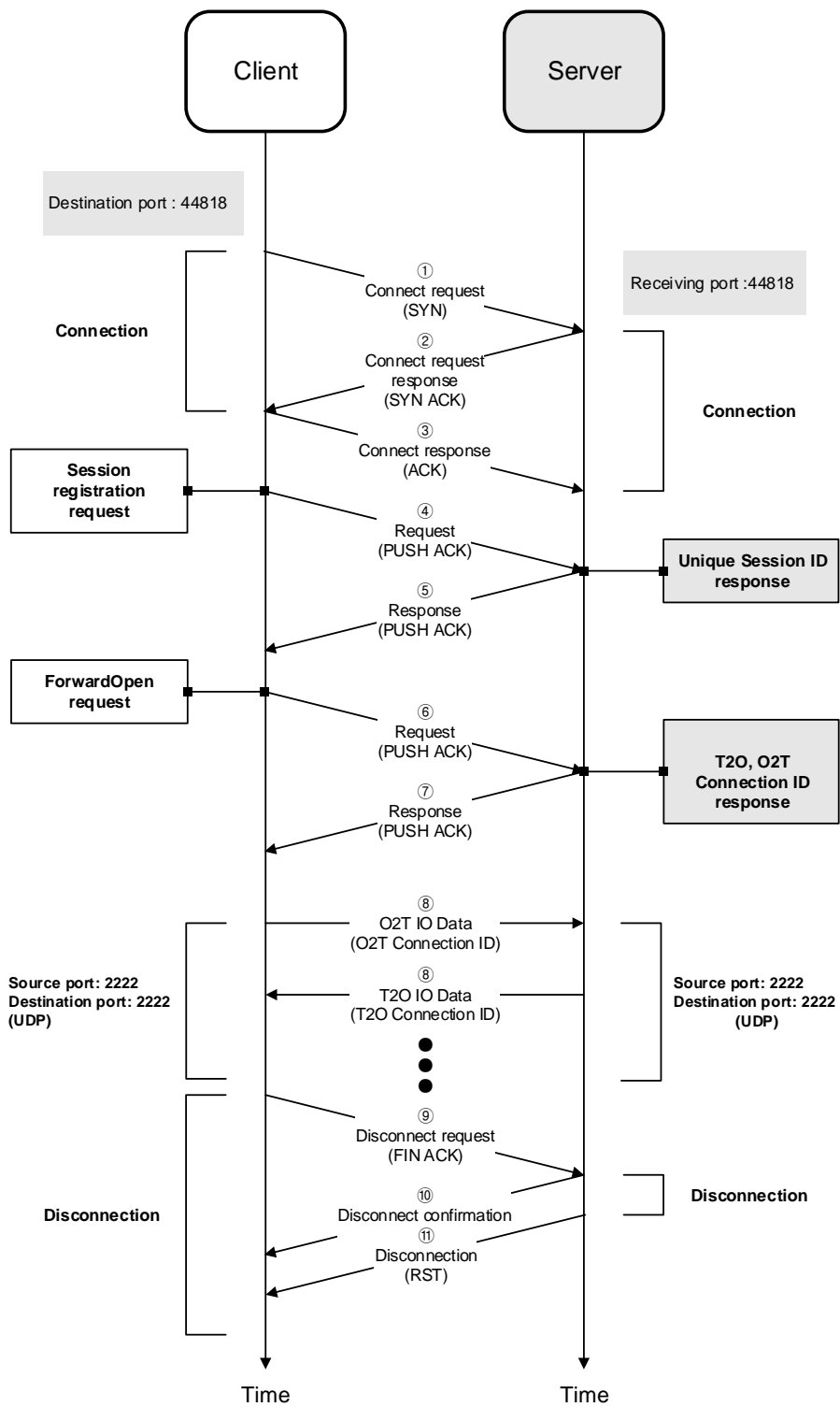

Cycle communication operation sequence

Notes

1) Implicit Client also generates data by Implicit Server. Depending on the type, the server can set the timeout as the period of the data to be provided by the client, or it can output to its own module using the data provided by the client.

• Non-periodic communication (Explicit)

The meaning of the explicit message provided by the non-periodic communication is a explicit message meaning a message containing all the information that can interpret the data in the corresponding data frame. Therefore, even if it takes some time to analyse the frame, if the desired message is sent without parameter setting process, the server interprets the frame and sends the response. It is mainly used for non-cycle data monitoring.

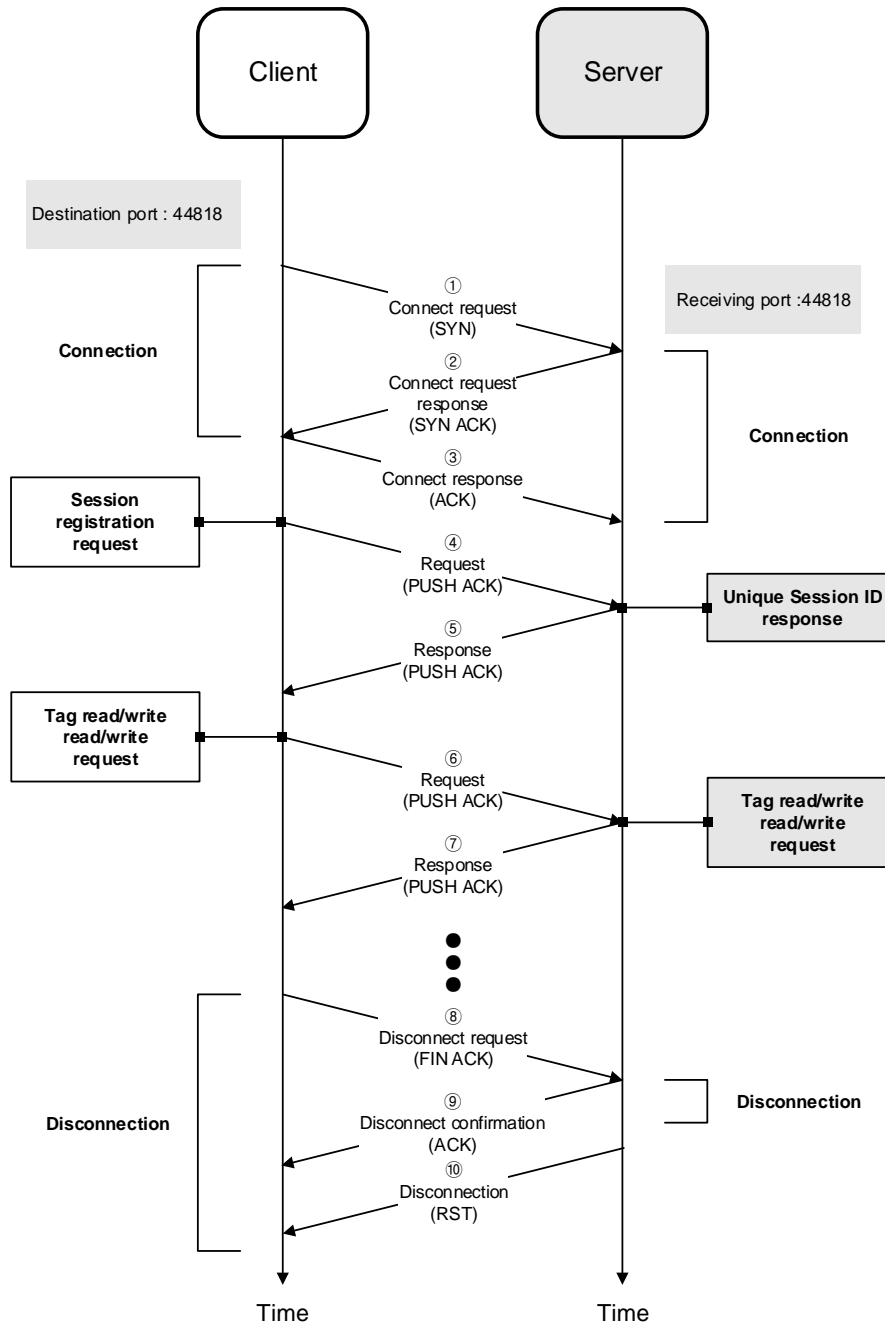

Non-cycle communication operation sequence

(2) EDS file

The EDS (Electrical Description Script) file is a manual for the device, which includes vendor ID, product type, version information, and connection information. It is based on setting the EDS file of the expansion device (EtherNet /IP slave) in the EtherNet /IP master module. EDS file can be downloaded from LS ELECTRIC website .(<http://www.lselectric.co.kr/>)

1) I/O type

- In/Out: If there is both input data and output data
- Input only: If there is only input data
- EO analog + Digital IO: XEL-BSSB Compatibility mode (Supports Smart I/O expansion only)
- IO analog + Digital I: XEL-BSSB Compatibility mode (Supports Smart I/O expansion only)
- LO analog + Digital I: XEL-BSSB Compatibility mode (Supports Smart I/O expansion only)

5.3.2 Data display type

EtherNet/IP server function uses a fixed data allocation method and a variable data allocation method.

I/O refresh data area (variable data allocation method) for cycle communication and non-cycle communication-read/write and fixed allocation data area for non-cycle communication-tag read/tag write are provided.

5.1.2The description is based on the system in the Data Allocation Example.

(1) Cycle communication

The data allocation for each expansion module is shown in the table below.

Slot number	Product name	Input size [Byte]	Output size [Byte]	Input refresh [Byte offset]	Output refresh [Byte offset]
-	Input Header	4	0	0~3	-
0	XGI-D22A	2	0	4~5	-
1	XGQ-TR2A	0	2	-	0~1
2	XGF-AV8A	26	2	6~31	2~3
3	XGF-DV8A	4	20	32~35	4~23
4	XGF-HO2A	46	4	36~81	24~27
5	XGI-D24A	4	0	82~85	-
-	Totals	86	28	-	-

(2) Non-cycle communication-read/write

1) Read/write communication parameters information

Content	Input data read	Output data write	Output data read
Service code	14 (0x0E)	16 (0x10)	14 (0x0E)
Class	04 (0x04)	04 (0x04)	04 (0x04)
Instance	161 (0xA1)	162 (0xA2)	162 (0xA2)
Attribute	03 (0x03)	03 (0x03)	03 (0x03)

2) Data allocation by expansion module

The data allocation for each expansion module is shown in the table cycle communication. (Input data :86 Bytes, output data:28 Bytes)

(3) Non-cycle communication-tag read/tag write

1) Format: [Device Name] [Size Prefix] [Offset]

Classification	Prefix	Meaning	Note
Device name	I	Digital input data	-
	Q	Digital output data	-
	U	Analog /special module data	-
	F	System flag ^{Note1}	-
Size prefix	X	BOOL(C1) ^{Note2}	1 bit size
	B	SINT(C2) ^{≠ 2} , USINT(C6), BYTE(D1)	1 Byte size (8 bits)
	W	INT(C3) ^{≠ 2} , UINT(C7), WORD(D2)	1 Word size(16 Bits)
	D	DINT(C4) ^{≠ 2} , UDINT(C8), DWORD(D3), REAL(CA)	1 Double word size (32 bits)
	L	LINT(C5) ^{≠ 2} , ULINT(C9), LWORD(D4), LREAL(CB)	1 Long word size (64 bits)
Offset	X	xxxxy ^{Note3}	1 bit offset
	B	xxxx ^{Note4}	1 Byte offset (8 bits)
	W	xxxx ^{Note4}	1 Word offset(16 Bits)
	D	xxxx ^{Note4}	1 Double word offset (32 bits)
	L	xxxx ^{Note4}	1 Long word offset (64 bits)

Note 1) For the meaning of each data of system flag, refer to Appendix A.2.1 Special Relay (F) List.

Note2) In the case of a tag write request, it responds with the same type as the requested type, In case of a tag read request, the type is not specified in the request frame. Therefore, it is fixed as BOOL (C1), SINT (C2), INT (C3), DINT (C4) and LINT(C5)

Note3) xxxx: Word offset, y: Bit offset of xxxx word

Note 4) xxxx: offset of the size prefix

2) Example

QX0001F F bit of the 1st word of digital output data
 IW00010 10th word of digital input area

3) Data allocation by expansion module

Slot number	Product Name	I	Q	U
0	XGI-D22A	IB0~IB7	QB0~QB7	UB0~UB63
1	XGQ-TR2A	IB8~IB15	QB8~QB15	UB64~UB127
2	XGF-AV8A	IB16~IB23	QB16~QB23	UB128~UB191
3	XGF-DV8A	IB24~IB31	QB24~QB31	UB192~UB255
4	XGF-HO2A	IB32~IB39	QB32~QB39	UB256~UB319
5	XGI-D24A	IB40~IB47	QB40~QB47	UB320~UB383

5.3.3 Server operation

(1) System configuration

System configuration and parameter setting for performing EtherNet/IP service operation are explained based on the use of the master module. Detailed system configuration is as follows.

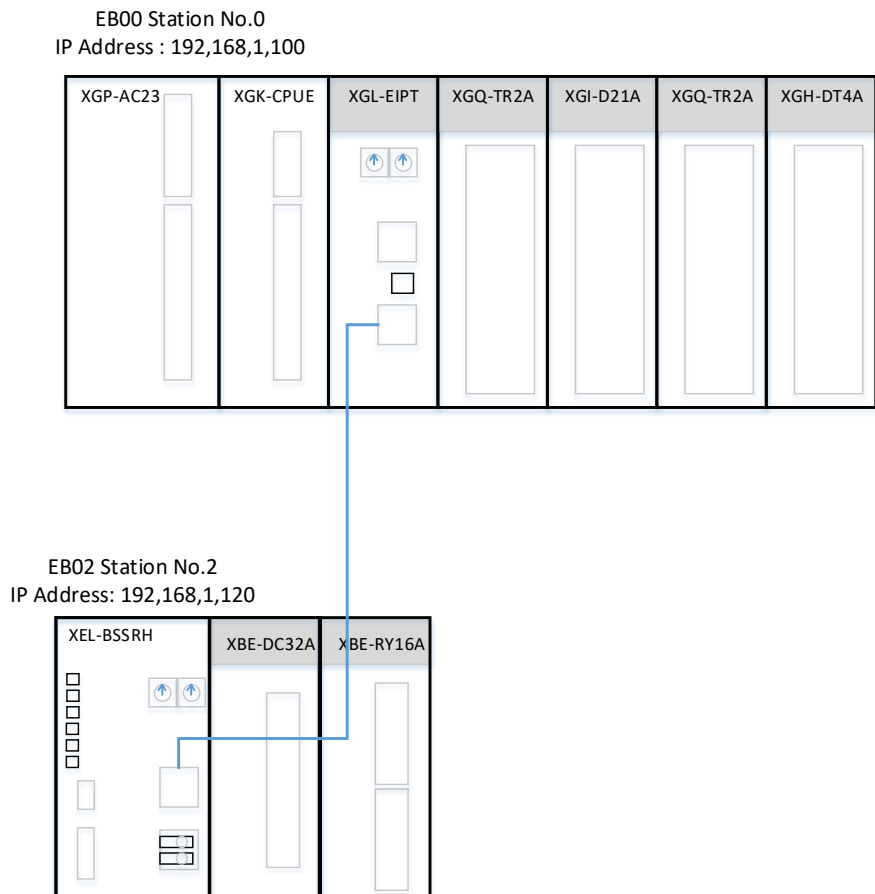

Setting item		Content		Setting program	
EtherNet/IP (Client)	Master setting		XGL-EIPT		XG5000
	Base No.		0		
	Slot No.		0		
	TCP/IP setting		IP address	192.168.1.100	
			Subnet mask	255.255.255.0	
			Gateway address	192.168.1.1	
	EIP Configuration and Channel		EIP network configuration		
	P2P start condition		_T100MS		
P2P method		Continuous			
Data type		WORD			
Smart I/O expansion (Server)	1 stages	Module parameter settings	IP address	192.168.1.120	XG5000
			Subnet mask	255.255.255.0	
			Gateway address	192.168.1.1	
			Station number	2	
		Input	8 byte	M0300	
Output :	2 byte	M0500			

(2) Server setting

[Basic parameter setting]

Use XG5000 to set the basic parameters of the slave as shown in the table of system configuration.

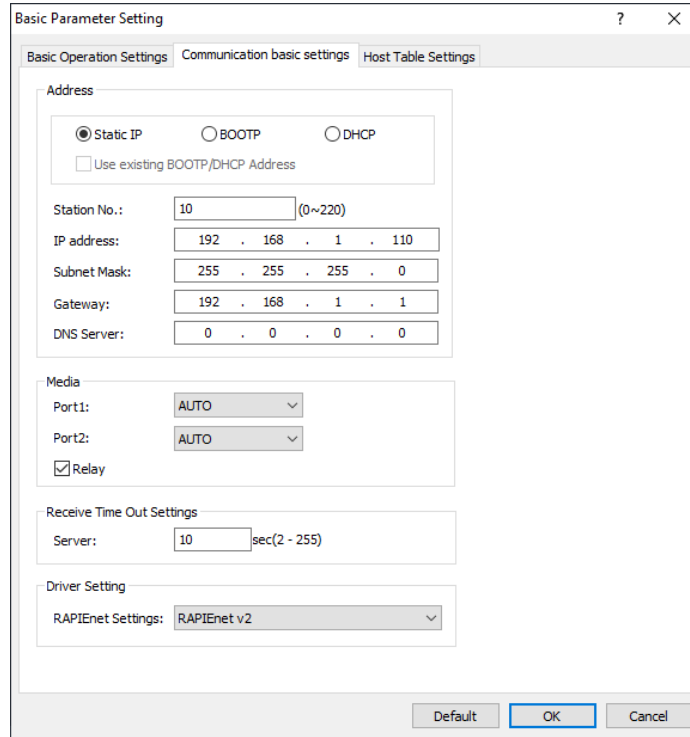

[I/O Parameter Setting]

Execute I/O synchronization in [XG5000] - [Online] - [Diagnostics] - [I/O Information] window.

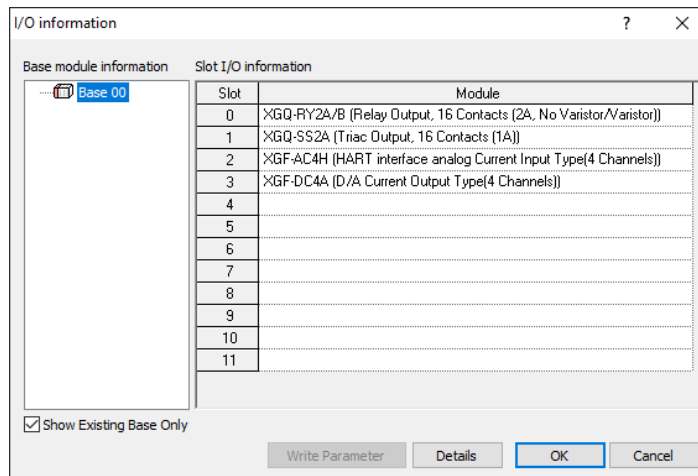

(3) Client setting

The following explanation is based on the example of using XGL-EIPT as a client module for EtherNet/IP service operation.

[Basic parameter setting]

Use XG5000 to set the basic parameters of XGL-EIPT as shown in the table of system configuration.

Please refer to the XGL-EIPT user's manual.

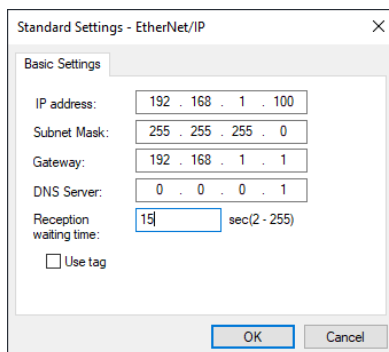

1) P2P setting

After adding P2P communication, set EIP configuration (P2P channel) and P2P block parameters.

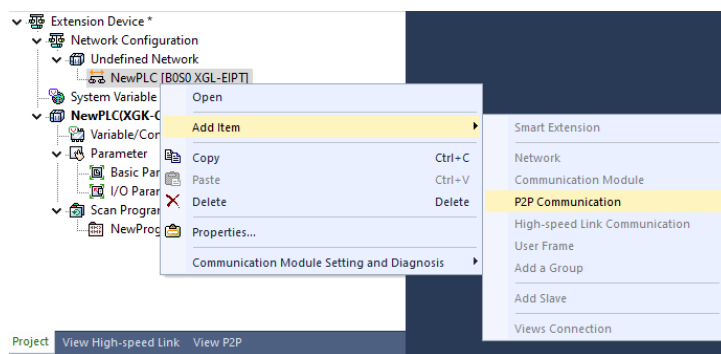

Click EIP configuration (Channel setting) and drag the information of the expansion device from the EDS information to add it to the screen.

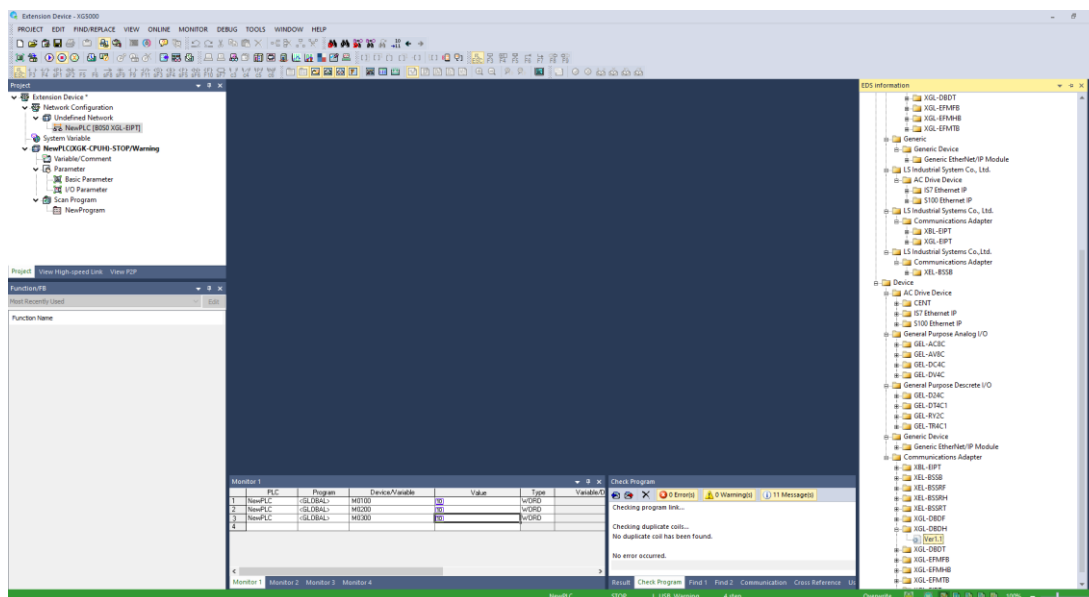

Set the EDS channel of the applicable expansion device.

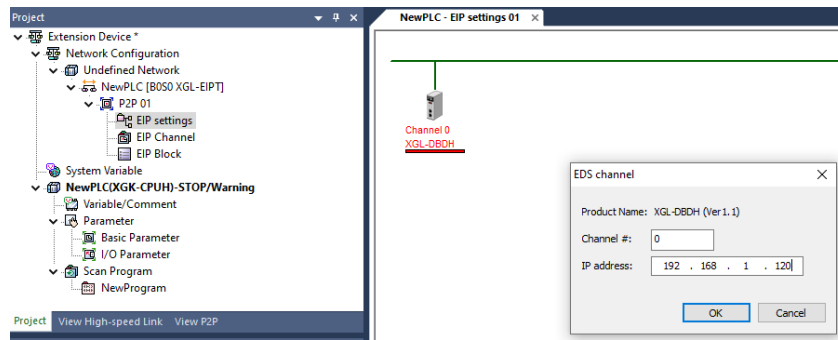

2) Tag settings

Click [Project]-[EtherNet/IP (OPC UA) Tag Settings] and the following screen appears. Parameter setting data size is set by I/O module installed in the Smart I/O expansion.

Mounting location	Model name	I/O Refresh size	Parameter setting	Device
Slot 0	XBE-D32A	4 Byte	T20 Size(Input) : 4 + 4 Byte	M00300
Slot 1	XBE-RY16A	2 Byte	O2T Size(output): 2 bytes	M00500

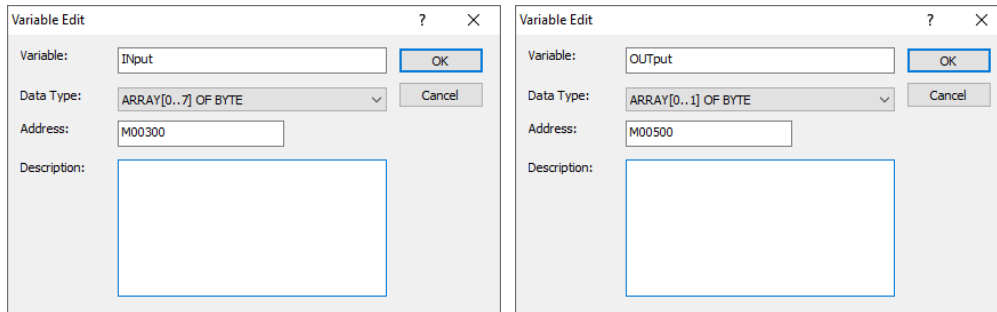

3) P2P block setting

Index	Ch	Operation mode	I/O type	Connection type	Function	Parameter	Parameter contents	Conditional flag	Transmission period(ms)	Timeout	Data Type	tag settings		
												Local tag	Remote tag	Data count
0	0	Implicit Client	0.In/Out	Multicast		Parameter	T20 Input Size:8 O2T Output Size:2		20	1. RPI x8	ARRAY[0..7] OF BYTE	INput/M00300		8
1		Implicit Client							20		ARRAY[0..1] OF BYTE	OUTput/M00500		2

Notes

- (1) Among 8 bytes (4 words) of M00300 set by local tag, LED display information input of Smart I/O expansion is used and information of input module is received by remaining 2 Word, that is, M00302 ~ M00303.
- (2) 2 Bytes (1 Word) data of M00500 set by the local tag is output to the output module (XBE-RY16A).

4) Setting parameter

Click the parameter to set.

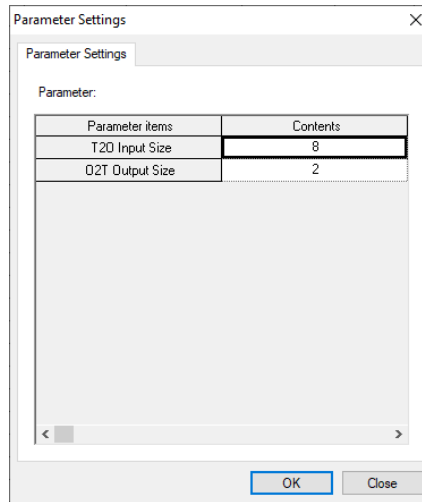

Click the local tag to select the variable registered as a tag.

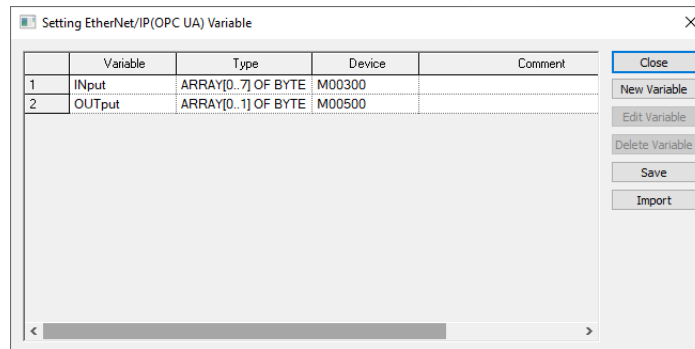

(4) Downloading parameter

When the P2P parameter setting is completed, you need to download the parameters to the PLC CPU and start the P2P service.

After selecting [Online] - [Write] in XG5000 menu window, select basic setting, P2P parameter and press OK to complete parameter download.

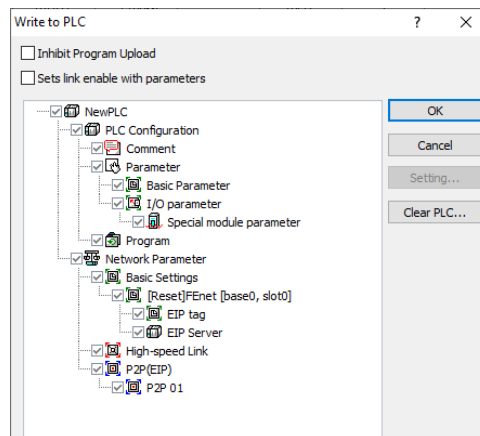

(5) Enable services

Enable P2P service with EtherNet/IP set via [XG5000] - [Online] - [Communication module setting] - [Service enable].

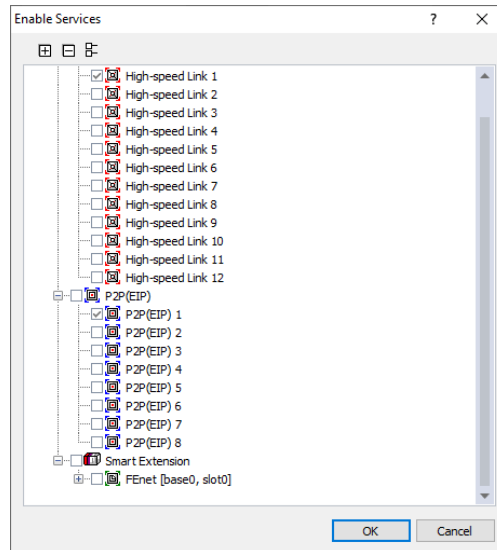

(6) Check Service Operation

Check through the EIP service in the service status of [XG5000] → [Online] → [Communication module setting] → [System Diagnosis].

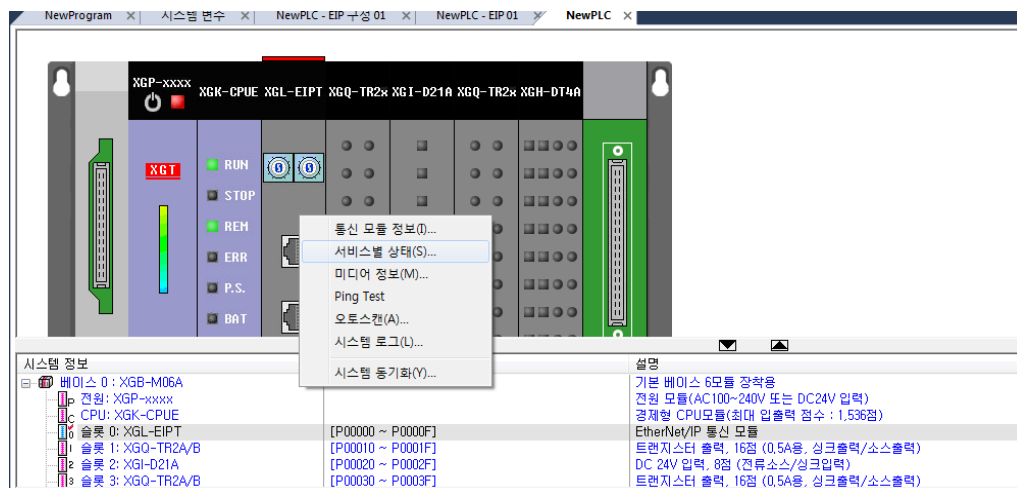

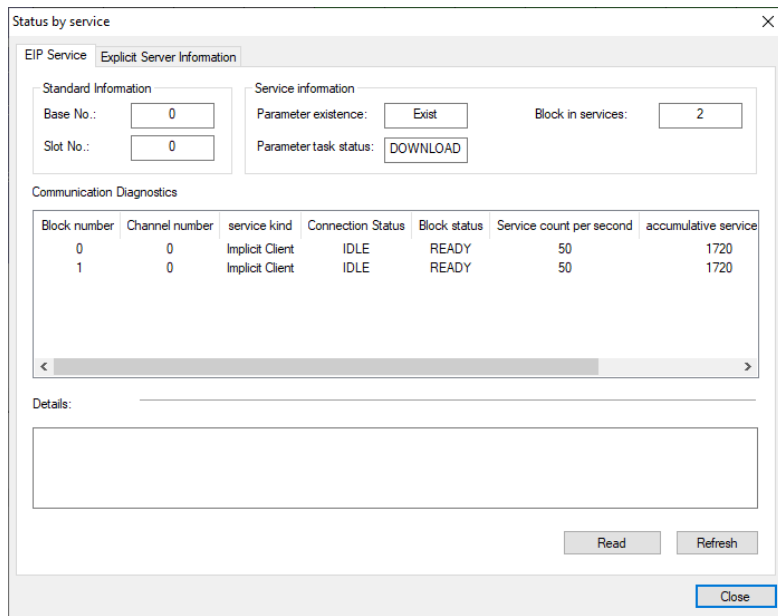

Notes

XEL-BSSRx can be used as an alternative to existing XEL-BSSB products.
Refer to Smart I/O user's manual for how to use XEL-BSSA.

5.4 Modbus/TCP server function

5.4.1 Overview

The Modbus/TCP protocol is the function to read and write data using the function code.

The Modbus/TCP frame consists of MAC, IP Header, TCP header and Modbus ADU for the Ethernet communication.

5.4.2 Modbus/ TCP communication parameter setting

Modbus data address format is composed of the following combinations.

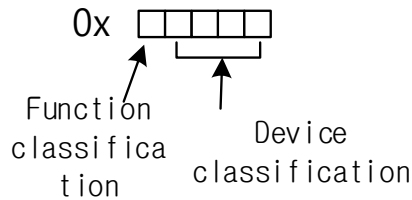

(1) Function-specific data address

The most significant digit of the data address is the part that is referenced by the master in order to create the Modbus function code, which is separated from the Modbus address on the actual frame. The Modbus address on the frame will only show the part indicated by XXXX.

Code	Function code name	Address	Note
01	Read output contact status (Read Coil Status)	0XXXX (bit-output)	Read bit
02	Read Input Status	1XXXX (bit-input)	Read bit
03	Read Holding Registers	4XXXX (word-output)	Read word
04	Read Input Registers	3XXXX (word-input)	Read word
05	Force Single Coil	0XXXX (bit-output)	Write bit
06	Preset Single Register	4XXXX (word-output)	Write word
15	Force Multiple Coils	0XXXX (bit-output)	Write bit
16	Preset Multiple Register	4XXXX (word-output)	Write word

(2) Modbus data address by device

The table below shows the Modbus addresses by device.

Device	Data address		Function code		Note
	Word type	Bit type	Word type	Bit type	
I ^{Note1}	0x0400~	0x4000~	04	02	
Q ^{Note1}	0x0400~	0x4000~	03,06,16,23	01,05,15	
U ^{Note1}	0x0600~	0x6000~	03,06,16,23	01,05,15	
F (Read Only) ^{Note3}	0x0800~	0x8000~	04	02,	
F (Read/Write) ^{Note3}	0x0A00~	0xA000~	03,06,16,23	01,05,15	
Input Refresh ^{Note2}	0x0200~	0x2000~	04	02,	
Output Refresh ^{Note2}	0x0200~	0x2000~	03,06,16,23	01,05,15	

Note1) I, Q, and U devices use fixed data allocation.

Note2) the input/output refresh area uses a variable data allocation method. The first 4 bytes of Input Refresh are added to the LED status information by default. Please be careful when calculating your address. For the LED status information, refer to Appendix A.4.

Note 3) for the meaning of each data of system flag, refer to Appendix A.2.1 Special relay (F) List.

(3) Example of data setting

5.1.2 The description is based on the system in the Data Allocation Example.

Slot number	Product Name	Input device (I)	Output device (Q)	Special module device(Q)
0	XGI-D22A	IW0		
1	XGQ-TR2A		QW4	
2	XGF-AV8A			UW64~UW75 UW84~UW85
3	XGF-DV8A			UW96~UW107
4	XGF-HO2A			UW128~UW152
5	XGI-D24A	IW20~IW21		

<Read area/Storage area parameter example>

Read 4th output contact of slot 0 (XGI-D22A) Input bit read (1) + data address (I device bit start address (4000) + offset) = 0x14004

Write 15th output contact of slot 1 (XGQ-TR2A): Write output bit (0) + data address (Q device bit start address (4000) + offset) = 0x0404F

Read CH0 conversion value of slot 2 (XGF-AV8A): U device word read (4) + data address (U device word start address (600) + offset) = 0x40642

Write CH1 output data of slot 3 (XGF-DV8A): U device word write(4) + data address (U device word start address (600) + offset) = 0x40663

5.4.3 Service operation

(1) System configuration

System configuration and parameter setting for performing Modbus/TCP service operation are explained based on the use of the master module. Detailed system configuration is as follows.

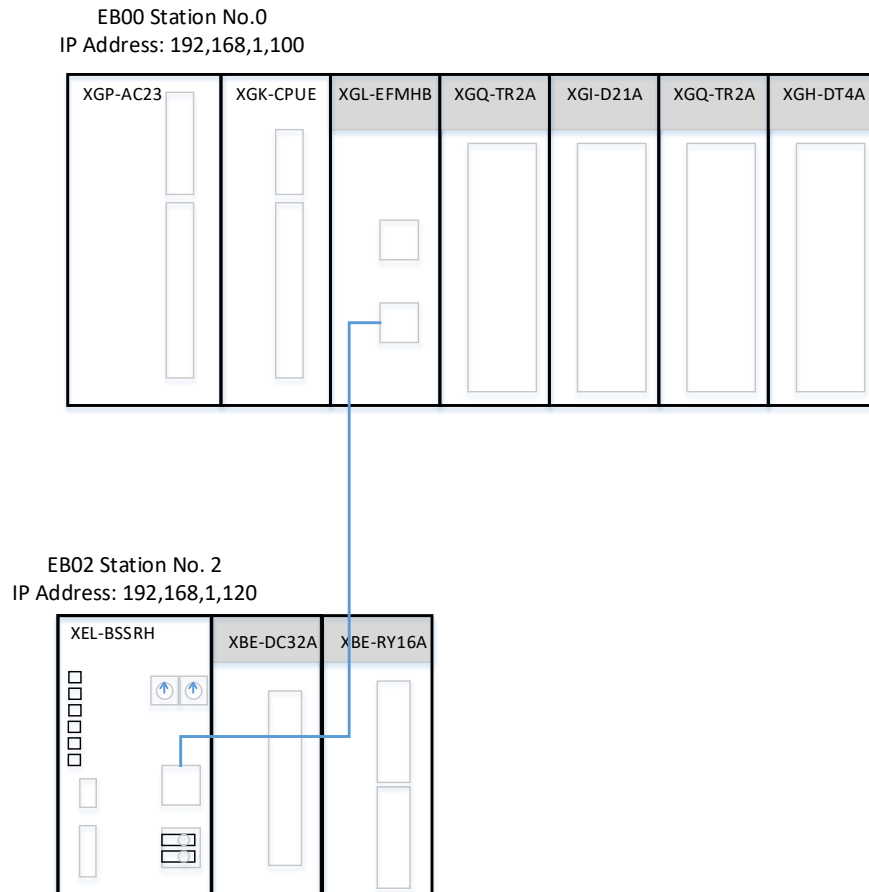

Setting item		Content		Setting program		
Ethernet module (Client)	Ethernet module		XGL-EFMHB		XG5000	
	Base No.		0			
	Slot No.		0			
	TCP/IP setting		IP address	192.168.1.100		
			Subnet mask	255.255.255.0		
			Gateway address	192.168.1.1		
	P2P channel setting		Modbus/TCP client			
	P2P start condition		_T100MS			
P2P method		Continuous				
Data type		Word				
Smart I/O expansion (Server)	1 stages	Module parameter settings		IP address	192.168.1.120	XG5000
				Subnet mask	255.255.255.0	
				Gateway address	192.168.1.1	
				Station number	2	
		Input	1 Word	M0010		
Output :	1 Word	M0020				

(2) Smart I/O expansion (Server) setting

[Basic parameter setting]

Use XG5000 to set the basic parameters of the server as the above system configuration.

When assigning fixed IP, the station number switch of communication device should be set to '00'.

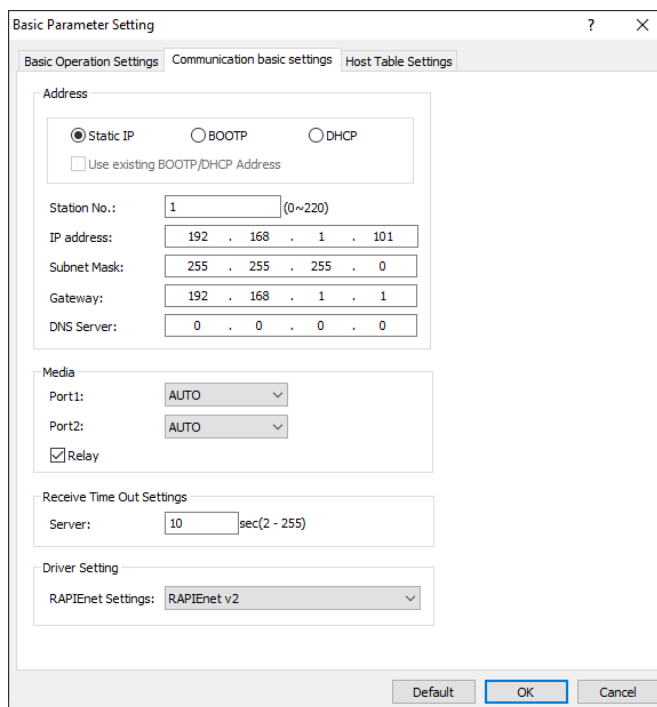

[I/O Parameter Setting]

Execute I/O synchronization in [XG5000] - [Online] - [Diagnostics] - [I/O Information] window.

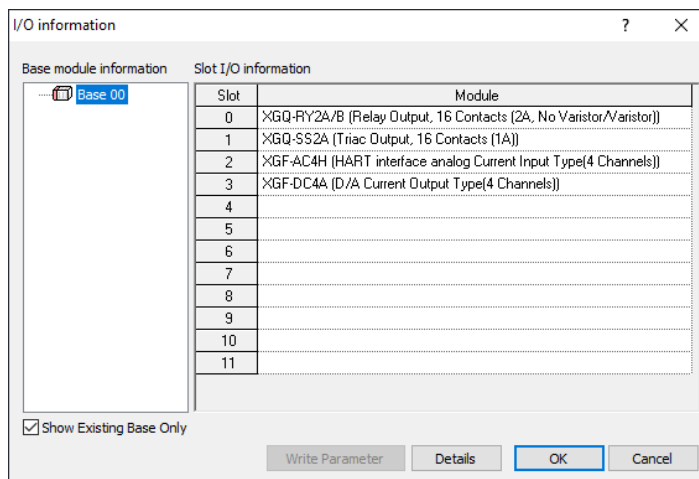

(3) Ethernet module (Client) setting

Modbus/TCP Service operation example is explained based on the application.

1) Basic parameter setting

Use XG5000 to set the basic settings of XGL-EFMTB to the same as the system configuration.

Add P2P and enter the IP address in the standard settings.

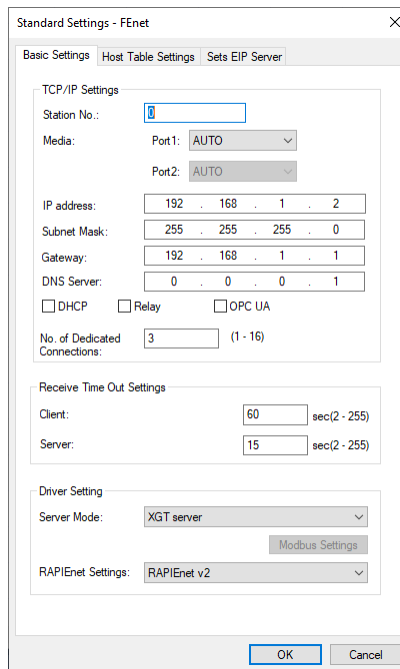

2) P2P channel setting

Enter the address of the Expansion adapter (server) as shown below.

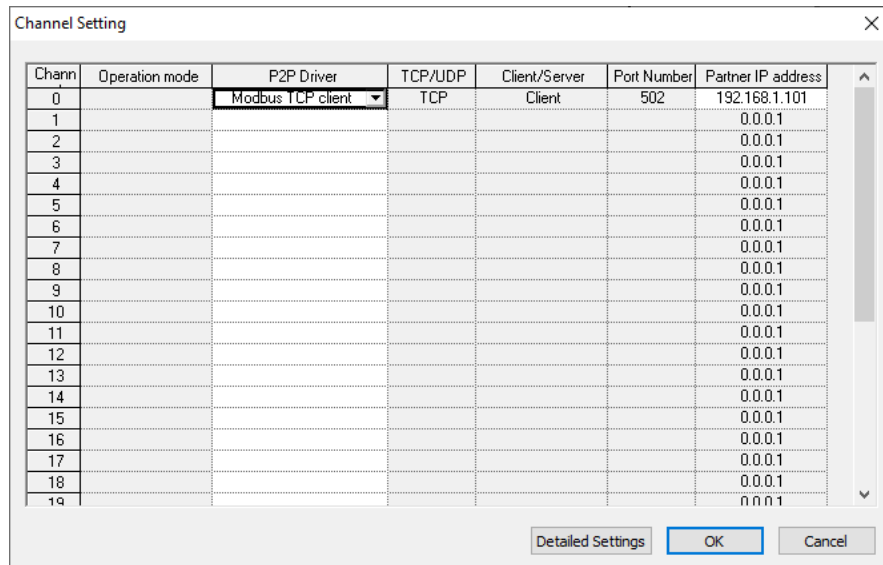

3) P2P block setting

After adding P2P communication, set EIP configuration (P2P channel) P2P block parameters.

Mounting location	Model name	I/O Refresh size	I/O area	Device
Slot 0	XBE-D32A	2Word	0x30202	M00010
Slot 1	XBE-RY16A	1Word	0x40200	M00020

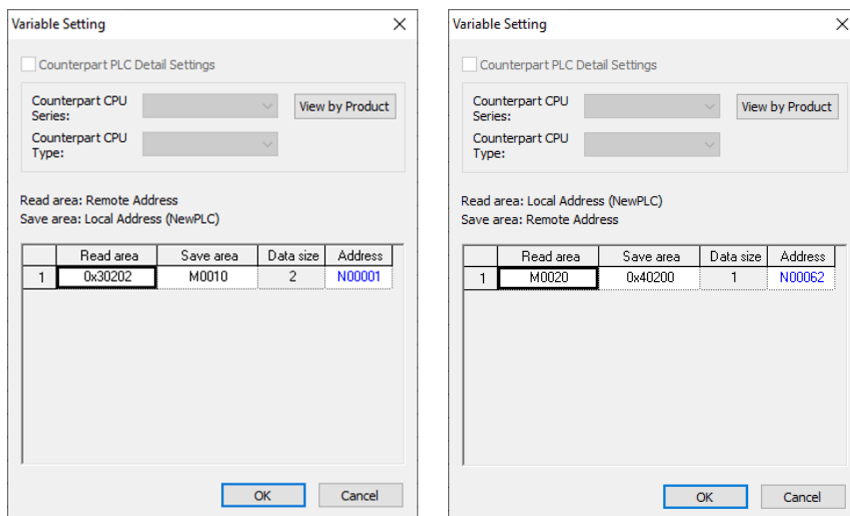

Notes

(1) Read data of input module from 0x30202 to 2 Word and save in M0010. From 0x30200 to 0x30201, the first 4 bytes of the input refresh contain the LED status information.

(2) Output 1 Word data of M0020 to the output module (XBE-RY16A)

Set the P2P Block.

Index	E-mail	Ch	Driver Setting	Header	P2P function	Conditional flag	Command type	Data Type	No. of variables	Data size	Destination station	Destination station number	Frame	Setting	Variable setting contents
0	<input type="checkbox"/>	0	Modbus TCP client		READ	_T100MS	1. Single	WORD	1		<input checked="" type="checkbox"/>	0		Setting	Number:1 READ1:0x30202.SAVE1:M0010.SIZE:2
1	<input type="checkbox"/>	0	Modbus TCP client		WRITE	_T100MS	1. Single	WORD	1		<input checked="" type="checkbox"/>	0		Setting	Number:1 READ1:M0020.SAVE1:0x40200.SIZE:1

(4) Downloading parameter

When the P2P parameter setting is completed, you need to download the parameters to the PLC CPU and start the P2P service. After selecting [Online]-[Write] in XG5000 menu window, select basic setting, P2P parameter and press OK to complete parameter download.

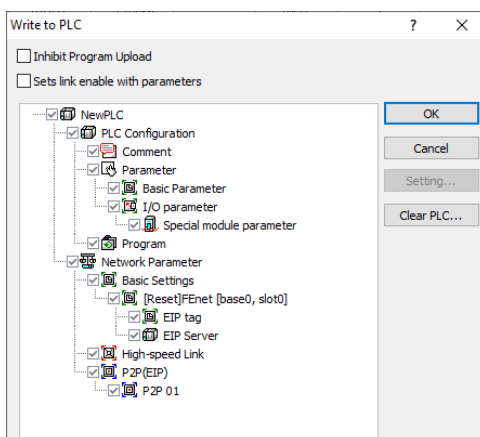

(5) Enable services

Enable P2P service with Modbus/TCP set via [XG5000] - [Online] - [Communication module setting] - [Service enable].

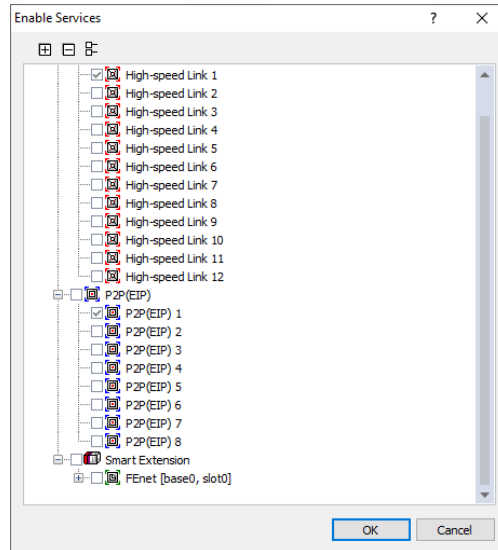

(6) Check Service Operation

Enable P2P service with Modbus/TCP set via [XG5000] → [Online] → [Communication module setting] → [Service enable].

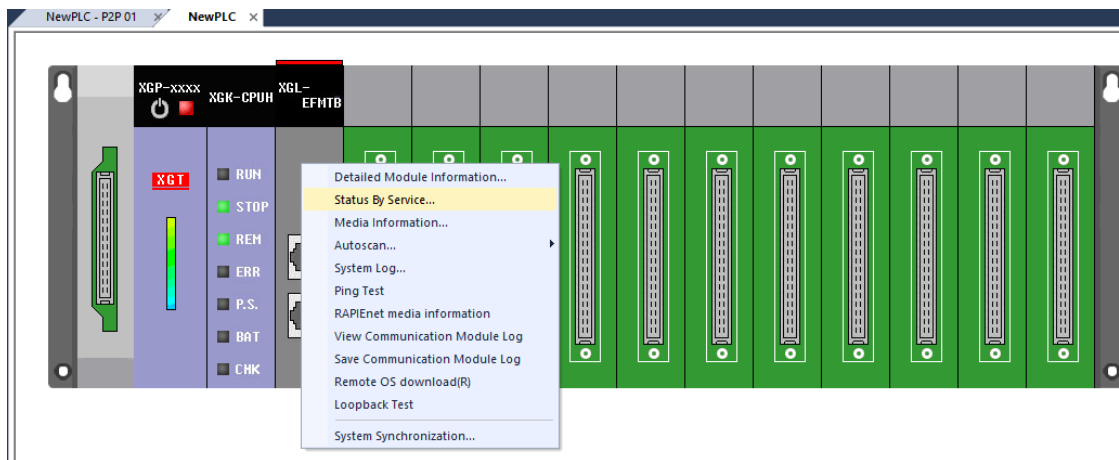

P2P service normal operation can be confirmed.

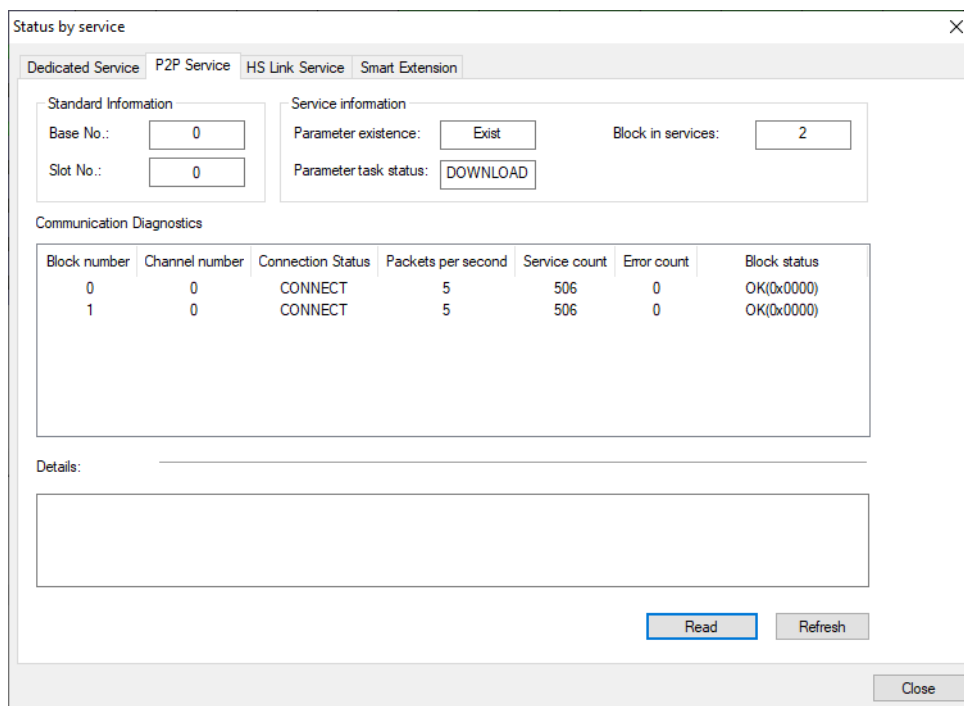

Notes

- (1) XEL-BSSRx can be used as an alternative to existing XEL-BSSA products.
- (2) Refer to Smart I/O user's manual for how to use XEL-BSSA.

5.5 Ethernet System Configuration

The Ethernet system can be connected to the public network with the open protocols Modbus/TCP and Ethernet/IP. Therefore, on-site PLC system access is possible by using GLOFA VIEW (latest: InfoU, XP, iXP) of wide area monitoring system 1,2. In addition, a local monitoring system directly connected to the site network allows access to on-site PLC systems.

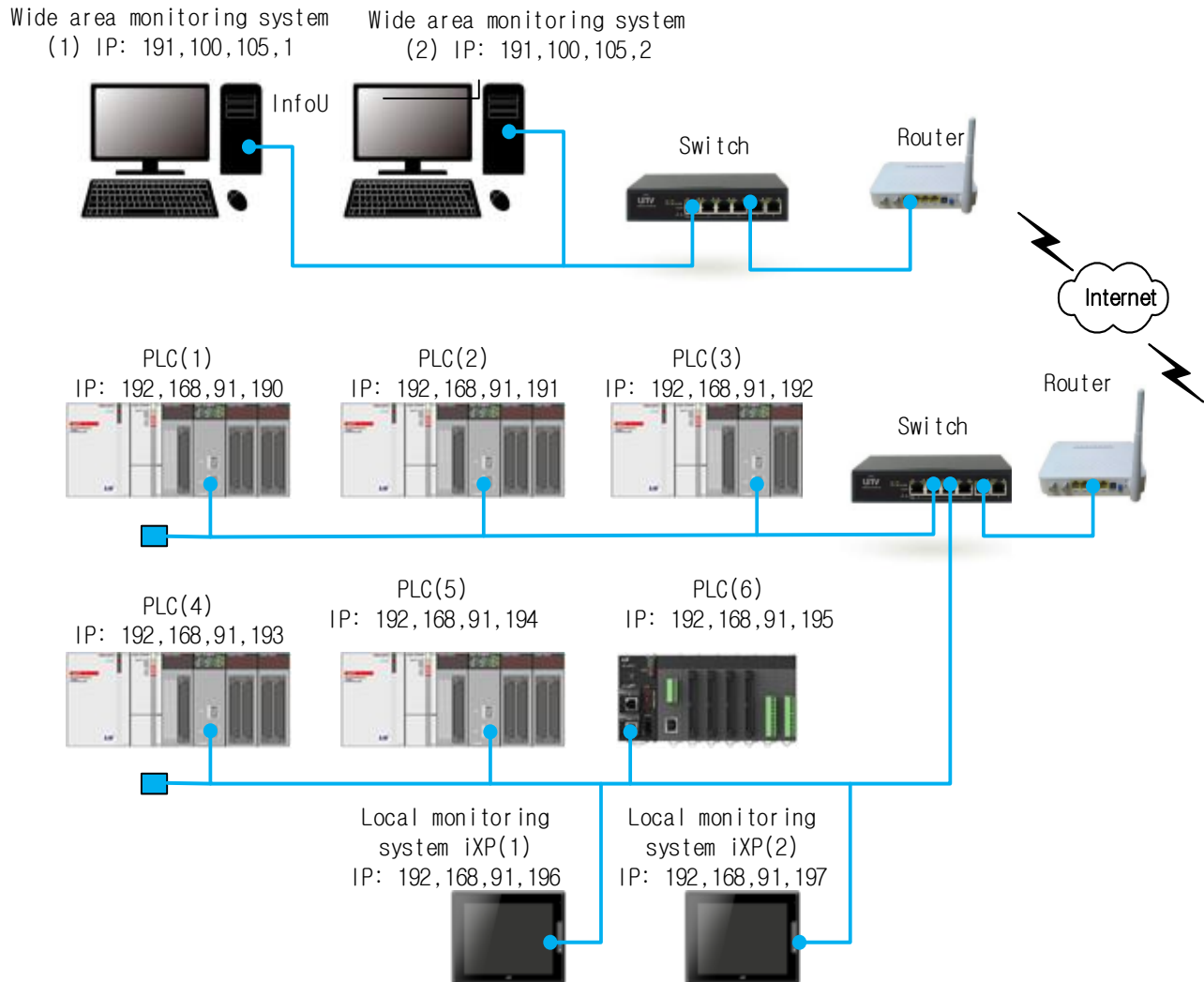

5.6 Modbus/ TCP protocol configuration

5.6.1 Modbus/TCP operation

The Modbus/TCP server operates in the following time sequence.

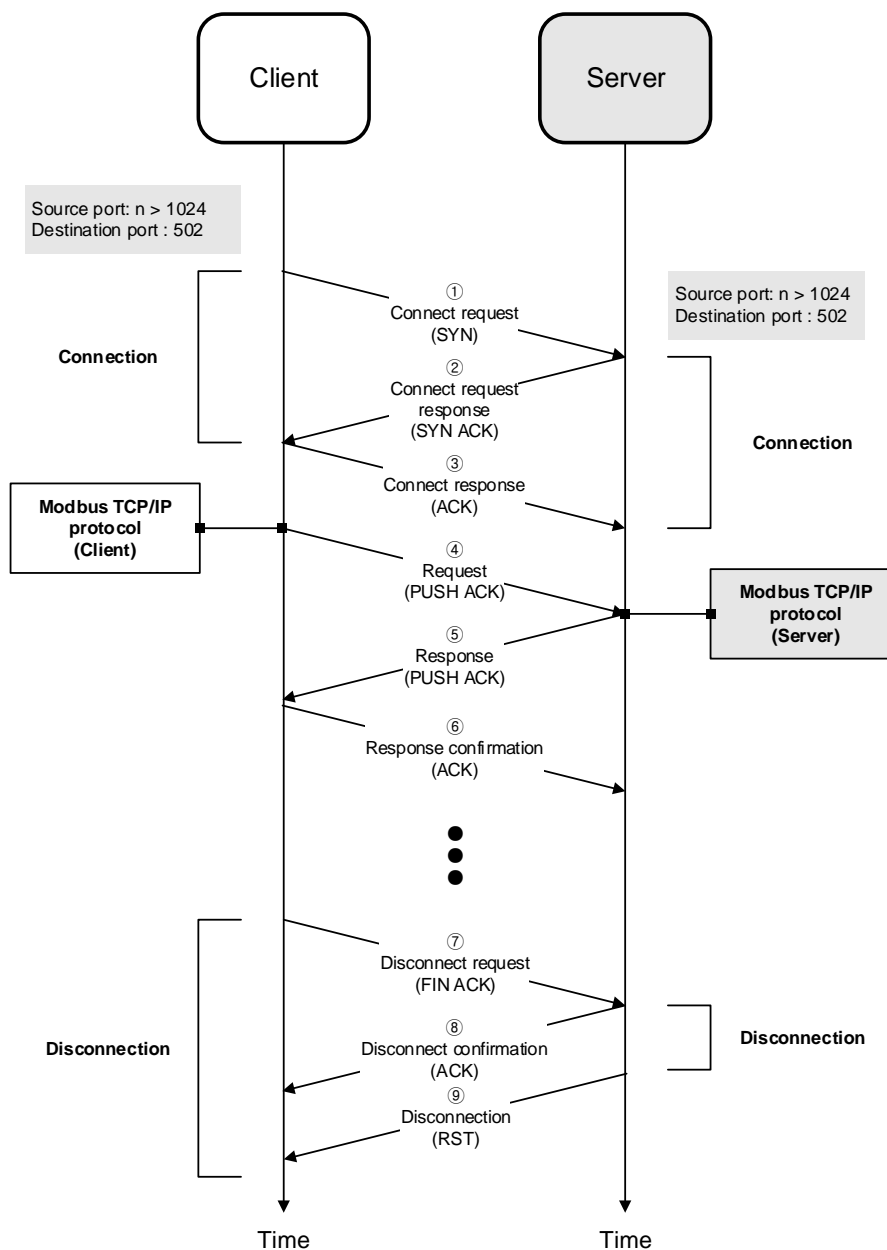

• Connection

The client transmits the request for connection ① to the server and the server transmits the response to the request for connection ②.

The connection port number of the Modbus/ TCP protocol is 502.

The client sends the response for the confirmation of connection ③.

When steps ① to ③ are completed, the connection between the client and the server will be established.

• Modbus/TCP server

After the connection is established, the client transmits ④ a request frame according to the Modbus/ TCP protocol.

The server transmits a response ⑤ to the request frame.

The client transmits the confirmation of the response ⑥.

• Disconnection

The client transmits the request for disconnection ⑦.

The server transmits the confirmation of disconnection ⑧ and terminates the connection ⑨.

(1) Modbus/TCP frame structure

- Modbus/TCP frame structure

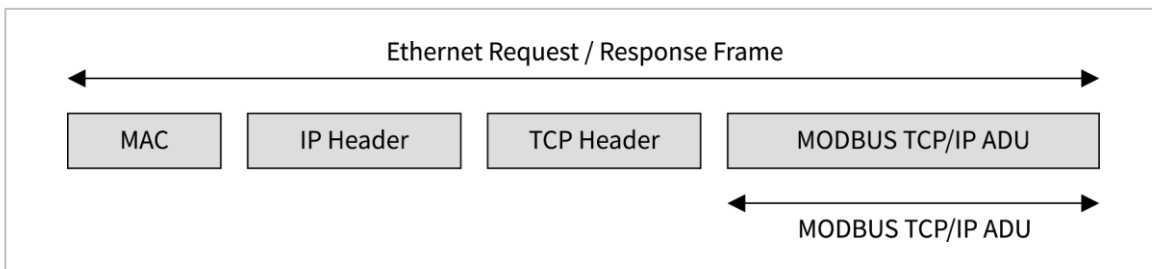

- Modbus ADU structure

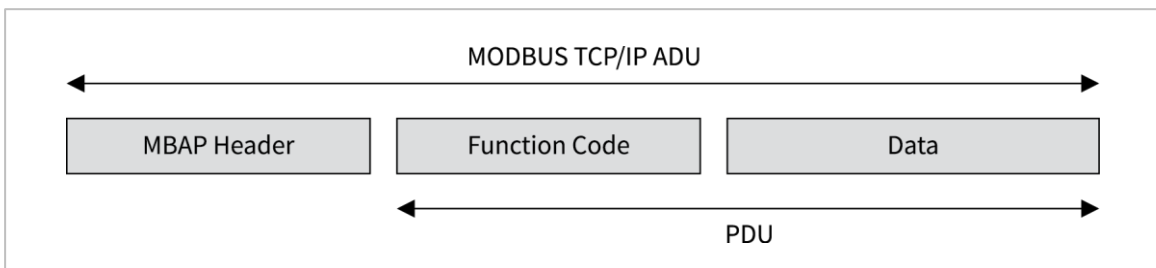

- Modbus MBAP structure

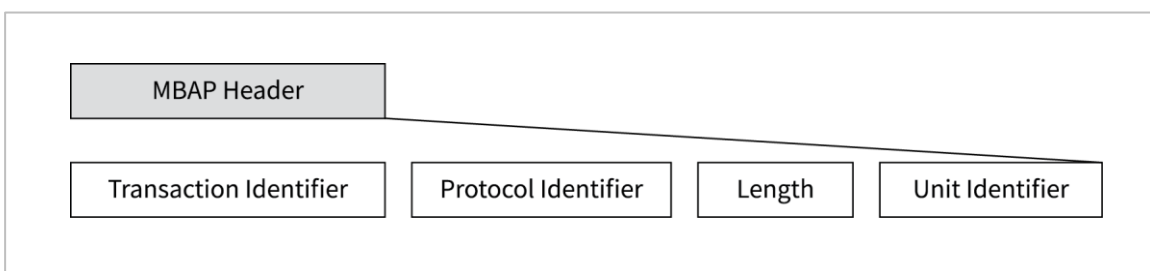

Notes

- (1) ADU: Application Data Unit
- (2) MBAP: Modbus Application Protocol
- (3) PDU: Protocol Data Unit

5.6.2 Modbus TCP function code list and frame structure

(1) Modbus/TCP function code list

Classification of function code	Function	Modbus transcription
Function Code 01 (h01)	Read bit output	Read Coils
Function Code 02 (h02)	Read bit input	Read Discrete Inputs
Function Code 03 (h03)	Read output word	Read Holding Registers
Function Code 04 (h04)	Read input word	Read Input Registers
Function Code 05 (h05)	Write bit output	Write single Coil
Function Code 06 (h06)	Write word output	Write Single Register
Function Code 15 (h0F)	Write output bit continuously	Write Multiple Coils
Function Code 16 (h10)	Write output word continuously	Write Multiple Registers

(2) Frame structure

1) [Function code h01: Read bit output (Read Coils)]

· Request

Classification	Size	Range
Function code	1 Byte	h01
Start address	2 Byte	h0000 ~ hFFFF
Number of coils	2 Byte	h0001 ~ h07D0 (2,000 bits)

· Response

Classification	Size	Range
Function code	1 Byte	h01
Number of bytes	2 Byte	N
Coil status	n byte	n = N or N + 1

· Error

Classification	Size	Range
Function code	1 Byte	h81 (function code + h80)
Exception code	1 bytes	h01, h02, h03, h04

· Example

Request frame		Response frame	
Classification	HEX	Classification	HEX
Function code	h01	Function code	h01
Start address (upper byte)	h00	Number of bytes	h03
Start address (lower byte)	h13	Coil status (27-20)	hCD
Number of coils (upper byte)	h00	Coil status (36-28)	h6B
Number of coils (lower byte)	h13	Coil status (38-36)	h05

2) [Function code h02 :Read bit input (Read Discrete Inputs)]

· Request

Classification	Size	Range
Function code	1 Byte	h02
Start address	2 Byte	h0000 ~ hFFFF
Number of inputs	2 Bytes	h0001 ~ h07D0 (2,000 bits)

· Response

Classification	Size	Range
Function code	1 Byte	h01
Number of bytes	2 Byte	N
Input status	N x 1 byte	-

· Error

Classification	Size	Range
Function code	1 Byte	h82 (function code + h80)
Exception code	1 bytes	h01, h02, h03, h04

· Example

Request frame		Response frame	
Classification	HEX	Classification	HEX
Function code	h02	Function code	h02
Start address (upper byte)	h00	Start address (upper byte)	h00
Start address (lower byte)	hC4	Start address (lower byte)	hC4
Input status (upper byte)	h00	Input status (upper byte)	h00
Number of coils (lower byte)	h16	Number of coils (lower byte)	h16

3) [Function code h03:Read output word(Read Holding Registers)]

· Request

Classification	Size	Range
Function code	1 Byte	h03
Start address	2 Byte	h0000 ~ hFFFF
Number of inputs	2 Bytes	h0001 ~ h007D (125 words)

· Response

Classification	Size	Range
Function code	1 Byte	h01
Number of bytes	2 Byte	2 x N
Input status	N x 2 bytes	-

· Error

Classification	Size	Range
Function code	1 Byte	h83 (function code + h80)
Exception code	1 bytes	h01, h02, h03, h04

· Example

Request frame		Response frame	
Classification	HEX	Classification	HEX

Function code	h03	Function code	h03
Start address (upper byte)	h00	Number of bytes	h06
Start address (lower byte)	h6B	Word status (108)	h02
Number of words (upper byte)	h00	Word status (108)	h2B
Number of words (lower byte)	h03	Word status (109)	h00
		Word status (109)	h00
		Word status (110)	h00
		Word status (110)	h64

4) [Function code h04:Read **input word**(Read Input Registers)]

· Request

Classification	Size	Range
Function code	1 Byte	h04
Start address	2 Byte	h0000 ~ hFFFF
Number of inputs	2 Bytes	h0001 ~ h007D (125 words)

· Response

Classification	Size	Range
Function code	1 Bytes	h04
Number of bytes	2 Bytes	2 x N
Input status	N x 2 bytes	-

· Error

Classification	Size	Range
Function code	1 Bytes	h84 (function code + h80)
Exception code	1 bytes	h01, h02, h03, h04

· Example

Request frame		Response frame	
Classification	HEX	Classification	HEX
Function code	h04	Function code	h04
Start address (upper byte)	h00	Number of bytes	h02
Start address (lower byte)	h08	Word status (108)	h00
Number of words (upper byte)	h00	Word status (108)	h0A
Number of words (lower byte)	h01		

5) [Function code h05:Write bit output(Write Single Coil)]

· Request

Classification	Size	Range
Function code	1 Bytes	h05
Start address	2 Bytes	h0000 ~ hFFFF
Input value	2 Bytes	h0000 or hFF0D

· Response

Classification	Size	Range
Function code	1 Bytes	h05
Number of bytes	2 Bytes	h0000 ~ hFFFF

Input status	2 Bytes	h0000 or hFF00
--------------	---------	----------------

· Error

Classification	Size	Range
Function code	1 Byte	h85 (function code + h80)
Exception code	1 bytes	h01, h02, h03, h04

· Example

Request frame		Response frame	
Classification	HEX	Classification	HEX
Function code	h02	Function code	h02
Start address (upper byte)	h00	Start address (upper byte)	h00
Start address (lower byte)	hC4	Start address (lower byte)	hC4
Input status (upper byte)	h00	Input status (upper byte)	h00
Number of coils (lower byte)	h16	Number of coils (lower byte)	h16

6) • Function code h0F:Write output word continuously (Write Multiple Registers)

· Request

Classification	Size	Range
Function code	1 Byte	h0F
Start address	2 Byte	h0000 ~ hFFFF
Number of output	2 Byte	h0001 ~ h07BD
Number of bytes	1 Byte	N
Output value	N x 1 byte	

· Response

Classification	Size	Range
Function code	1 Byte	h0F
Number of bytes	2 Bytes	h0000 ~ hFFFF
Input status	2 Byte	h0001 ~ h07B0

· Error

Classification	Size	Range
Function code	1 Byte	h8F (function code + h80)
Exception code	1 bytes	h01, h02, h03, h04

· Example

Request frame		Response frame	
Classification	HEX	Classification	HEX
Function code	h0F	Function code	h0F
Start address (upper byte)	h00	Start address (upper byte)	h00
Start address (lower byte)	h13	Start address (lower byte)	h13
Number of output (upper byte)	h00	Number of output (upper byte)	h00
Number of output (lower byte)	h0A	Number of output (lower byte)	h0A
Number of bytes	h02		
Output value (upper byte)	hCD		
Output value (lower byte)	h01		

7) [Function code h06:Write word output(Write Single Register)]

· Request

Classification	Size	Range
Function code	1 Byte	h06
Start address	2 Byte	h0000 ~ hFFFF
Output value	2 Byte	h0000 or hFFFF

· Response

Classification	Size	Range
Function code	1 Byte	h06
Start address	2 Byte	h0000 ~ hFFFF
Output value	2 Byte	h0000 or hFFFF

· Error

Classification	Size	Range
Function code	1 Byte	h86 (function code + h80)
Exception code	1 bytes	h01, h02, h03, h04

· Example

Request frame		Response frame	
Classification	HEX	Classification	HEX
Function code	h06	Function code	h06
Start address (upper byte)	h00	Start address (upper byte)	h00
Start address (lower byte)	h01	Start address (lower byte)	h01
Input status (upper byte)	h00	Input status (upper byte)	h00

8) [Function code h10: Write Multiple Registers

· Request

Classification	Size	Range
Function code	1 Byte	h10
Start address	2 Byte	h0000 ~ hFFFF
Number of output	2 Byte	h0001 or h07D8
Number of bytes	1 Byte	2 x N
Output value	N x 2 bytes	Value

· Response

Classification	Size	Range
Function code	1 Byte	h10
Number of bytes	2 Byte	h0000 ~ hFFFF
Number of output	2 Byte	h0001 ~ h007B

· Error

Classification	Size	Range
Function code	1 bytes	h90 (function code + h80)
Exception code	1 bytes	h01, h02, h03, h04

· Example

Request frame		Response frame	
Classification	HEX	Classification	HEX

Function code	h10	Function code	h01
Start address (upper byte)	h00	Start address (upper byte)	h00
Start address (lower byte)	h01	Start address (lower byte)	h01
Number of output (upper byte)	h00	Number of output (upper byte)	h00
Number of output (lower byte)	h02	Number of output (lower byte)	h02
Number of bytes	h04		
Output value (upper byte)	h00		
Output value (lower byte)	h0A		
Output value (upper byte)	h01		
Output value (lower byte)	h02		

5.7 Ethernet System Configuration

The Ethernet system can be connected to the public network with the open protocols Modbus/TCP and Ethernet/IP. Therefore, on-site PLC system access is possible by using GLOFA VIEW (latest: InfoU, XP, iXP) of wide area monitoring system 1,2. In addition, a local monitoring system directly connected to the site network allows access to on-site PLC systems.

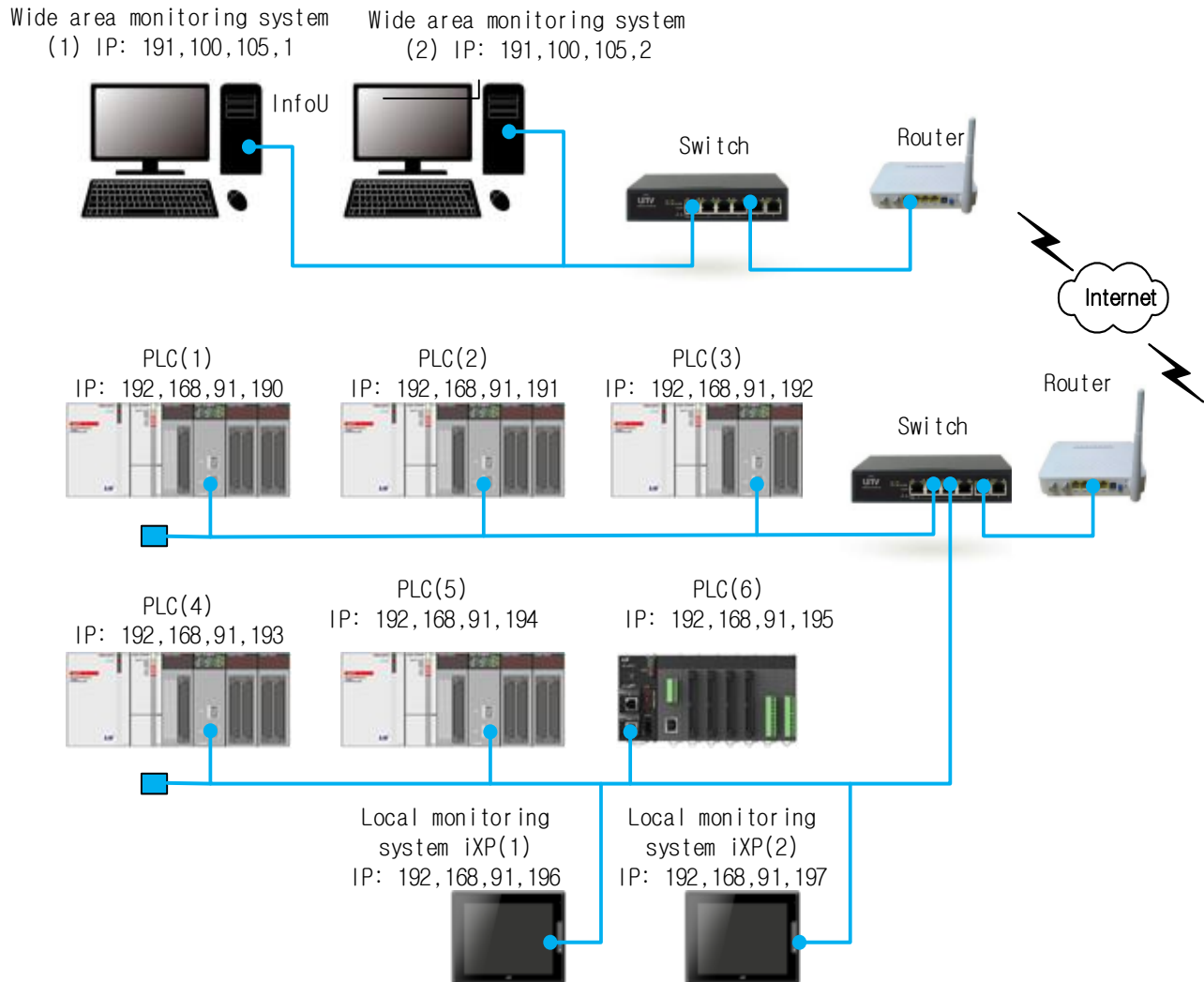

Chapter 6 Troubleshooting

An explanation of how to check the causes of a failure or an error that may occur during system operation and measures. The following procedure can be used to check the status of the Communication device product. In order to judge the abnormal condition of the module, please take the necessary steps in order to solve the problem.

6.1 Confirmation by LED of Communication Module

To check the fault or status of the module, check the status of the communication module according to the lighting status of the LED.

6.1.1 Abnormal operation display of Expansion driver

Please check the table below according to the LED on the front of the module.

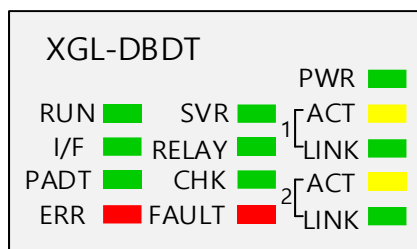

LED contents	Error contents	Solution	
		When connecting to our own master	When connecting a third party master
PWR	LED Off	Check if the power supply is abnormal.	
RUN	LED Off	1) Check the master's mode. (CPU mode on the master side is STOP)	-
	LED flickers	1) Master's Smart Extension Service Check the Enable status.	-
ERR	LED On	1) Check that I / O module mounting configuration is the same as the set value. 2) Check I / O module mounting and dismounting 3) Check the CPU error status.	
CHK	LED flickers	1) Check the cable connection. (RING connection → LINE connection)	
	LED On	1) Check the status of POWER modules when setting the dual base.	
FAULT	ON	1) Check if there is a device with the same IP and station number on the network.	

6.1.2 Abnormal operation display of Smart I/O expansion

Please check the table below according to the LED on the front of the module.

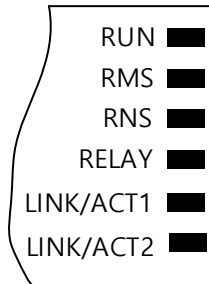

LED contents	Error contents	Solution
RUN	LED Off	Check if the power supply is abnormal.
	LED flickers	1) Occurs when there is a data transmission delay. Check the cable connection.
RMS (Module Status)	Green flicker	1) Check the basic parameter and communication parameter setting. 2) Check the IO synchronization and module parameter settings.
	Red flicker	1) Check the basic parameter and communication parameter setting. 2) Check the speed setting between ports
	RED On	1) Check for hardware failure
RNS (Network Status)	Green flicker	1) Product is initial state. 2) Check the cable connection. 3) Check the basic parameter and communication parameter setting. Check if basic parameters of FEnet module are normally configured by using XG5000. 4) Check if the function block / command input is made normally. 5) Check if the media connection is working properly. 6) Check if P2P link enable (allowed) of XG5000 menu is set.
	Red flicker	1) Check if the module number and IP address of the network modules are duplicated. 2) Check for unnecessary network send / receive data. 3) Check the cable connection.
	RED On	1) Check station No and IP address of the network modules are duplicated.

6.1.3 Abnormal operation display of Smart I / O block

Please check the table below according to the LED on the front of the module.



LED contents	Error contents	Solution	
		When connecting to our own master	When connecting a third party master
STATUS	RED On	1) Check the error by remote connection to Smart I / O block.	

6.2 Module Error by XG5000

6.2.1 Error check in XG5000

By XG5000 program, you can monitor the communication module abnormally. After connecting to CPU port, check through [Online] → [Diagnostics] → [PLC History] on [PLC Error/warning] of XG5000.

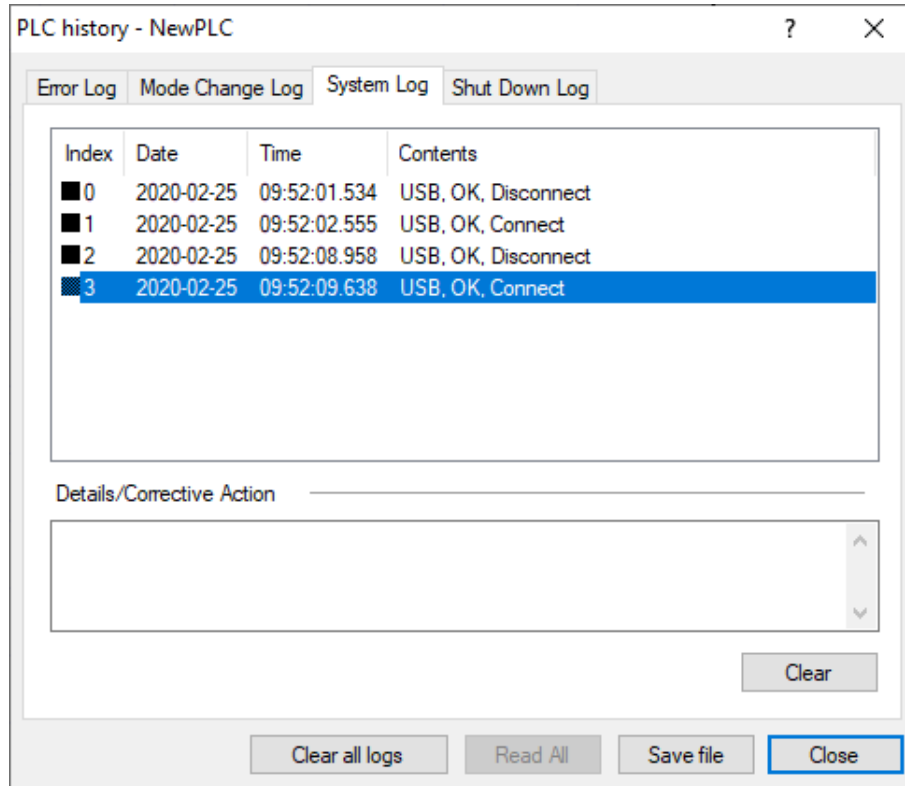

If the module has a hardware error or an interface error with an I / O module mounted on the same base, the LED of the communication module itself is abnormal. With XG5000, you can get status information briefly. The above figure is error / warning information that can be checked through [PLC History] of [Online] menu of XG5000.

6.3 Troubleshooting by Error

Troubleshooting method is to check the error history of XG5000 and LED status of Communication device module and then take measures.

6.3.1 Troubleshooting

(1) Extension driver module PWR LED Off: Hardware error Hardware error

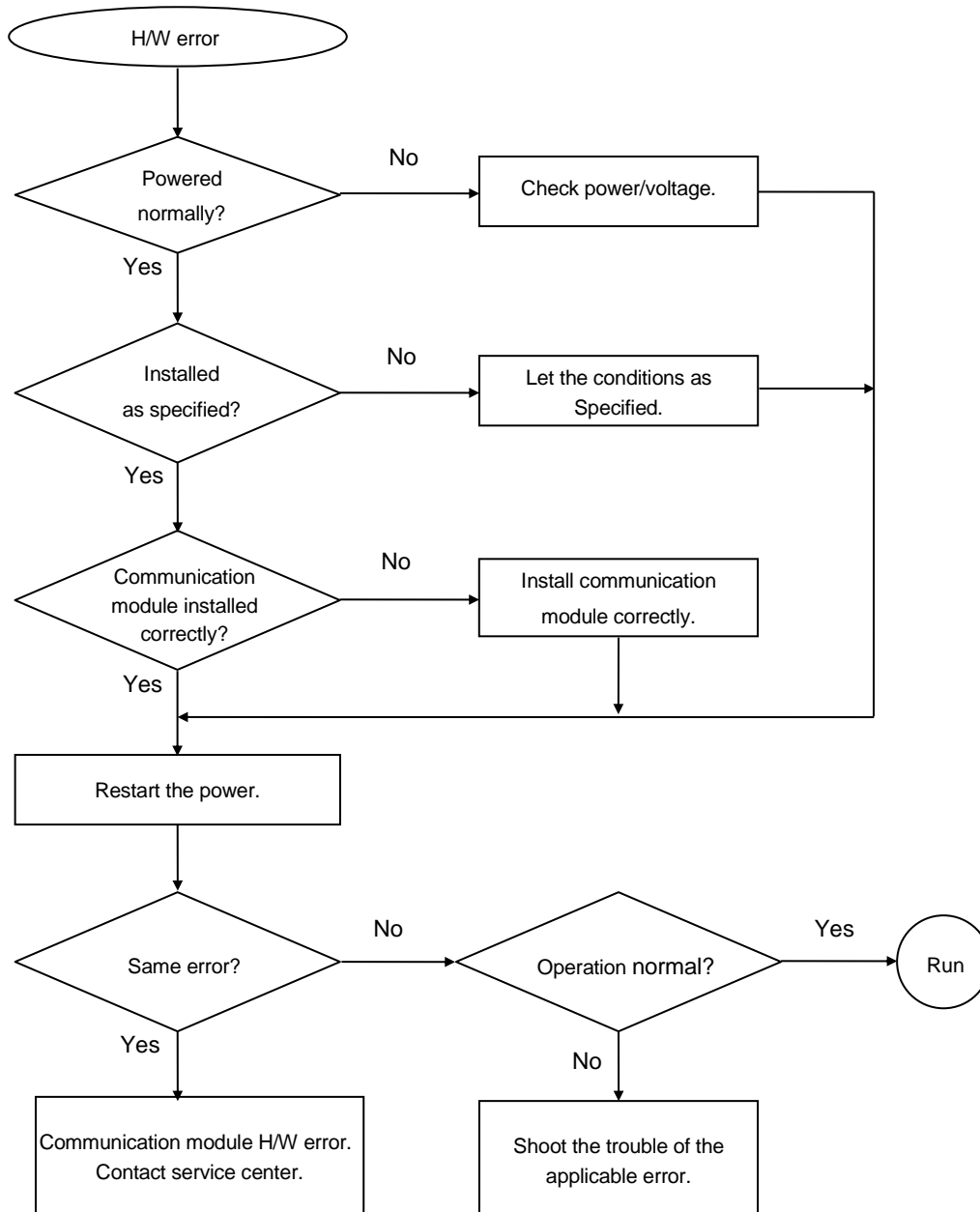

(2) Smart I/O expansion module RMS RED LED On - Device Hardware error

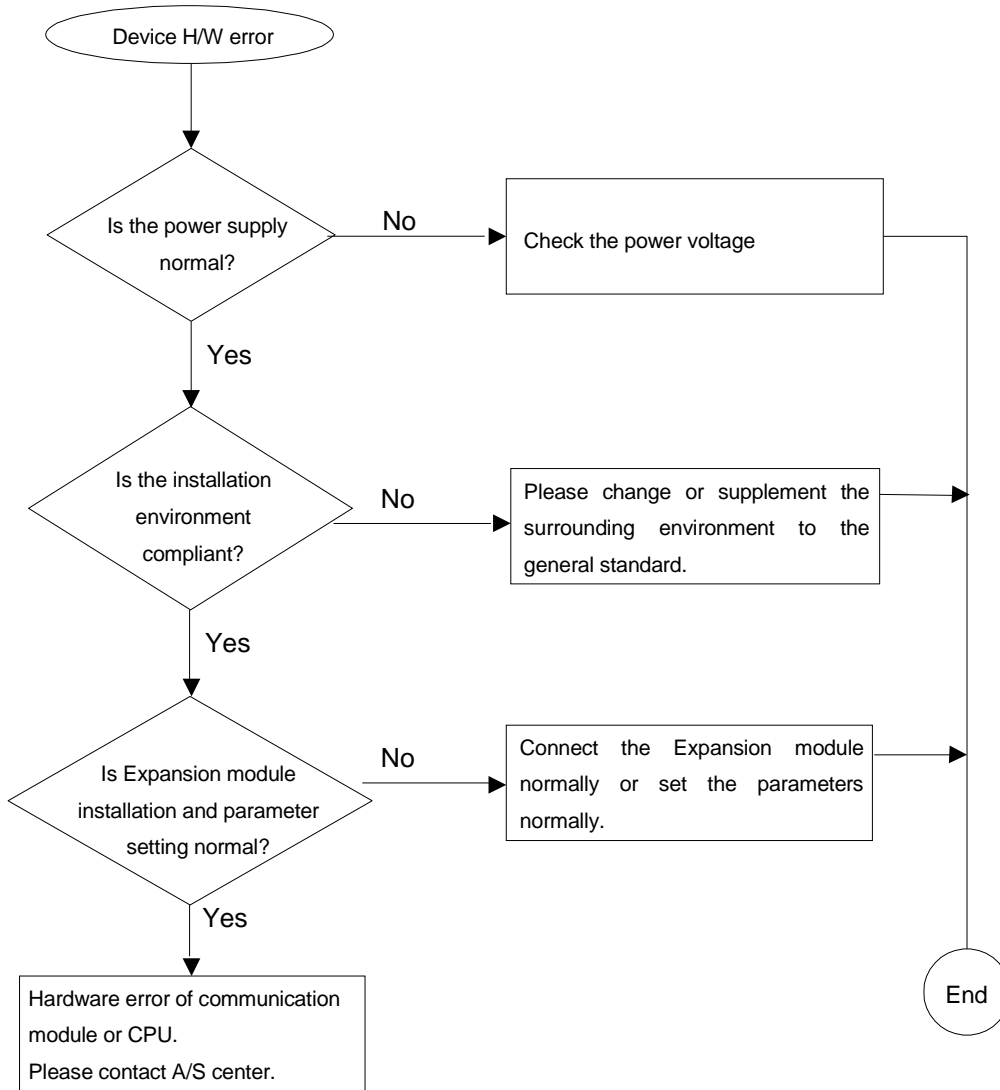

Chapter 7 EMC Standard

7.1 The Requirements for Compliance with EMC Standards

The EMC Directive specifies the products must “be so constructed that they do not cause excessive electromagnetic interference (emissions) and are not unduly affected by electromagnetic interference (immunity)”. The applicable products are requested to meet these requirements. This section summarizes the precautions on conformance to the EMC Directive of the machinery assembled using XGT PLC series. The details of these precautions are based on the requirements and the applicable standards control. However, LSIS will not guarantee that the overall machinery manufactured according to the details conforms to the below-described directives. The method of conformance to the EMC directive and the judgment on whether or not the machinery conforms to the EMC Directive must be determined finally by the manufacturer of the machinery

7.1.1 EMC Standard

The standards applicable to the EMC Directive are listed below.

Specifications	Test item	Test details	Standard value
EN50081-2	EN55011 Radiated noise * 2	Electromagnetic emissions from the product are measured	30~230 MHz QP : 50 dB μ V/m * 1 230~1000 MHz QP : 57 dB μ V/m
	EN55011 Conducted EM noise	Electromagnetic emissions from the product to the power line is measured.	150~500 kHz QP : 79 dB Mean : 66 dB 500~230 MHz QP : 73 dB Mean : 60 dB
EN61131-2	EN61000-4-2 Electrostatic immunity	Immunity test in which static electricity is applied to the case of the equipment	15 kV Aerial discharge 8 kV Contact discharge
	EN61000-4-4 Fast transient burst noise	Immunity test in which burst noise is applied to the power line and signal lines	Power line: 2 kV Digital I/O : 1 kV Analog I/O, signal lines: 1 kV
	EN61000-4-3 Radiated field AM modulation	Immunity test in which field is irradiated to the product	10Vm, 26~1000 MHz 80%AM modulation @ 1 kHz
	EN61000-4-12 Damped oscillatory wave immunity	Immunity Testing of Fluctuating Damped Oscillation in Electric Power Line	Power line: 1 kV Digital I/O (24V or higher): 1 kV

* 1: QP: Quasi-peak value, Mean: Average value

* 2: The PLC is an open type device (device installed to another device) and must be installed in a control panel.

The test was conducted while installed in the panel.

7.1.2 Panel

The PLC is an open type device (device installed to another device) and must be installed in a control panel. This is needed to prevent electric shock by touching XGT PLC and reduce the PLC generated noise.

Install the XGT PLC in a metallic panel to reduce PLC generated EMI (Electro-magnetic interference)

The specifications for the control panel are as follows.

(1) Control Panel

The PLC control panel must have the following features.

- 1) Use SPCC (Cold Rolled Mild Steel) for the control panel.
- 2) The steel plate should be thicker than 1.6mm.
- 3) Use isolating transformers to protect the power supply from external surge voltage.
- 4) The control panel must have a structure which the radio waves does not leak out. For example, make the door as a box-structure so that the panel body and the door are overlapped each other. This structure reduces the surge voltage generate by PLC.
- 5) To ensure good electrical contact with the control panel or base plate, mask painting and weld so that good surface contact can be made between the panel and plate.

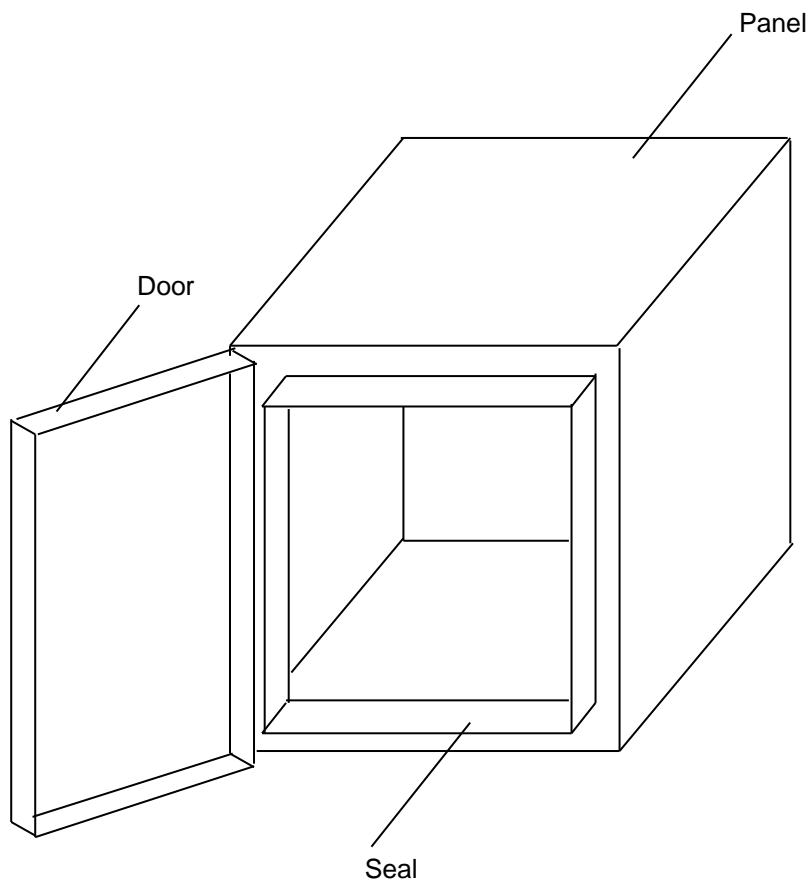

(2) Power and ground wiring

Grounding and power wiring of the PLC should be carried out as follows.

- 1) Ground the control panel with a short and thick grounding wire so that a low impedance can be secured at a high frequency.
- 2) The FG terminal plays the role of passing noise that is generated inside the PLC to the ground. Therefore, use a grounding wire that has as low impedance as possible.
- 3) The grounding wire can generate a noise, so grounding with a short and thick grounding wire prevents such wire from acting as an antenna.
- 4) Attach ferrite core to the power cable as shown in the figure below in order to secure the compliance to the CE specification.

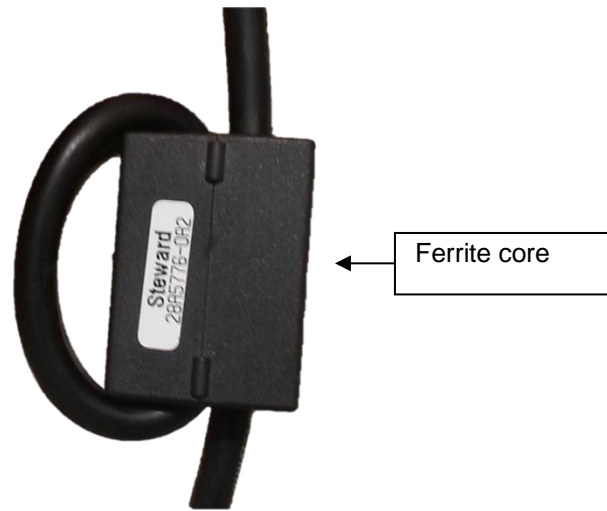

[Product for reference - Ferrite core]

Manufacturer	Model name of product	External dimension (mm)				Maximum diameter of cable (mm)	Note
		A	B	C	D		
Laird	28A3851-0A2	30.00	13.00	33.70	30.00	12.85	www.lairdtech.com
Laird	28A5776-0A2	29.20	20.00	42.00	42.00	19.40	www.lairdtech.com
Coilmaster	C2L RU130B	31.50	13.00	33.00	31.50	13.00	www.coilmaster.com.tw
TDK	ZCAT3035-1330	30.00	13.00	34.00	30.00	13.00	www.tdk.com

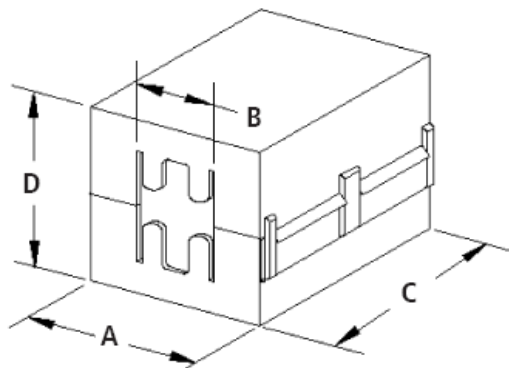

7.2 Requirement to Conform the Low-voltage Directive

The low-voltage directive requires each device that operates with the power supply ranging from 50V to 1000VAC and 75V to 1500VDC to satisfy the safety requirements. Cautions and installation and wiring of the XGT PLC series to conform to the low-voltage directive are described in this section. However, LSIS will not guarantee that the overall machinery manufactured according to the details conforms to the below-described directives. The method of conformance to the EMC directive and compliance to the EMC Directive must be determined by the manufacturer of the machinery.

7.2.1 Standards applicable to Communication device

The Communication device complies with EN6100-1 (safety of equipment used in measurement and control laboratories. Communication device have been developed in accordance with the above standards for modules operating at rated voltage of AC50V / DC75V or higher.

7.2.2 Selection of Communication device

(1) Smart I/O extension

The rated voltage of the adapter is the rated DC24V or less, so it is not included in the target of low-voltage directive.

(2) I/O module

The I/O modules whose rated voltage is AC110/220V series have dangerous voltages (peak 42.4V or higher) inside, so CE mark-compliant models feature enhanced insulation between the primary and secondary windings. I/O modules of the rated DC24V or less are not included in the target range of low-voltage directive.

(3) Special and communication modules

The rated voltage of special and communication modules is less than DC24V, so these modules are not included in the target of low-voltage directive.

Appendix

A.1 Describes of terms

Describes the terms used in the user's manual

(1) Module

Devices, such as I / O boards, as standardized elements with certain functions that make up a system.

(2) I/O image area

Saves I / O information to PLC internal memory area to display I / O status.

(3) Auto-MDIX(Automatic Medium Dependent Interface Crossover) The type of Ethernet cable is divided into Crossover Cable (TX-RX, RX-TX) and Straight Cable (TX-TX, RX-RX), where the TX / RX is interchanged based on TX / RX. Communication of each network device is possible through connection of TX (node A) -RX (node B) / RX (node A) -TX (node B), so it is impossible to communicate with Straight Cable. However, if there is a function that can electrically exchange TX and RX in the connected node, it is possible to communicate with each other using a straight cable, which is called Auto-MDIX.

(4) Auto-Negotiation

Ethernet is the process by which Ethernet devices exchange information about performance, such as operation speed and duplex mode.

- 1) Find out why connection was denied
- 2) Determine the performance of your network equipment
- 3) Change connection speed

(5) ARP(Address Resolution Protocol)

Protocol to search for MAC address by means of correspondent IP address on the Ethernet LAN

(6) Bridge

A device used to connect two networks so to be operated as one network. Bridge is used not only to connect two different types of networks but also to divide one big network into two small networks in order to increase the performance

(7) Client

A user of the network service, or a computer or program (mainly the one requesting services) using other computer's resource.

(8) CSMA/CD(Carrier Sense Multiple Access with Collision Detection)

Each client checks if there is any sign prior to transmission of data to the network (Carrier Sense) and then sends its data when the network is empty. At this time, all the clients have the equal right to send (Multiple Access). If two or more clients send data, collision may occur. The client who detects the collision tries to send again in a specific time.

(9) DHCP(Dynamic Host Configuration Protocol)

Communication protocol IP standard for automatically allocating and managing setting information necessary for executing TCP / IP communication. Provides uniform management of IP addresses in telecommunication networks in TCP / IP environments.

(10) DNS(Domain Name System)

A method used to convert alphabetic Domain Name on the Internet to its identical Internet number (namely, IP address).

(11) Dot Address

Shows IP address of '100.100.100.100', where each figure is displayed in decimal with 1 byte occupied respectively for 4 bytes in total.

(12) Duplex

It means duplex communication that can send / receive in both directions. Separate the send and receive paths so that they can operate without being affected by each other.

(13) EDS file

Abbreviation for Electronic Data Sheets, a file containing information about the device and its communication settings.

(14) E-mail address

The address of the user with login account for the specific machine connected via the Internet. Usually user's ID @ domain name (machine name) is assigned. In other words, it will be like hjee@microsoft.com, where @ is called as 'at' displayed with shift+2 pressed on the keyboard. The letters at the back of @ are for the domain name of specific company (school, institute,..) connected with the Internet, and the letters in front of @ are for the user ID registered in the machine. The last letters of the domain name are for the highest level. USA generally uses the following abbreviation as specified below, and Korea uses .kr to stand for Korea. com : usually for companies) / .edu : usually for educational organizations such as universities. / .ac(academy) is mostly used in Korea / .gov : for governmental organizations. For example, nasa.gov is for NASA (government) / .mil : military related sites. For example, af.mil is for USA air force (military)/ .org : private organizations / .au : Australia / .uk : the United Kingdom / .ca : Canada / .kr : Korea / .jp : Japan / .fr : France / .tw : Taiwan, etc.

(15) Ethernet

A representative LAN connection system (IEEE 802.3) developed by Xerox, Intel and DEC of America which can send about 10Mbps and use the packet of 1.5kB. Since Ethernet can allow various types of computers to be connected as one via the network, it has been called a pronoun of LAN as a universal standard with various products available, not limited to some specific companies

(16) Explicit Messaging

In addition to the explicit message and data, this message contains all the information that can be interpreted in the frame.

(XGT EtherNet / IP module provides non-cycle client communication)

(17) FDDI(Fiber Distributed Data Interface)

Based on optical cable, provides 100Mbps, Shared Media Network as Dual Ring method, Token Passing is done in two-way. Max 200Km distance for entire network, Max 2Km between Nodes, Max 500 nodes. Generally, this used as Backbone Network.

(18) FTP(File Transfer Protocol)

An application program used to transfer files between computers among application programs providing TCP/IP protocol. If an account is allowed to the computer to log in, fast log in the computer is available wherever the computer is so to copy files.

(19) Gateway

Software/Hardware used to translate for two different protocols to work together, which is equivalent to the gateway necessary to exchange information with the different system.

(20) Header

Part of the packet including self station number, correspondent station number and error checking area.

(21) HTML

Hypertext Markup Language, standard language of WWW. In other words, it is a language system to prepare Hypertext documents. The document made of HTML can be viewed through the web browser

(22) HTTP

Hypertext Transfer Protocol, standard protocol of WWW. It is a protocol supporting the hypermedia system.

(23) ICMP(Internet Control Message Protocol)

An extended protocol of IP address used to create error messages and test packets to control the Internet.

(24) Implicit Messaging

Implicit messages and messages with minimal header information other than data.

(XGT EtherNet / IP module provides cycle client / cycle server communication)

(25) IEEE 802.3

IEEE 802.3 specifies standards for CSMA/CD based Ethernet Exactly it is a LAN based on CSMA/CD (Carrier Sense Multiple Access with Collision Detection) Ethernet designed by IEEE 802.3 group, which is classified into detailed projects as specified below.

1) IEEE P802.3 - 10G Base T study Group

2) IEEE P802.3ah - Ethernet in the First Mile Task Force

IEEE P802.3ak - 10G Base-CX4 Task Force. Both IEEE 802.3 and Ethernet are broadband networks using the CSMA / CD scheme and have a common feature that is implemented in the network interface card hardware.

(26) IP(Internet Protocol)

Protocol at the network layer for the Internet

(27) IP Address

Address of respective computers on the Internet made of figures binary of 32 bits (4 bytes) to distinguish the applicable machine on the Internet. Classified into 2 sections, network distinguishing address and host distinguishing address. The network address and the host address is respectively divided into class A, B and C based on the bits allotted. IP address since it shall be unique all over the world, shall be decided not optionally but as assigned by NIC(Network Information Center) of the applicable district when joining the Internet. In Korea, KRNIC(Korea Network Information Center) is in charge of this work. Ex.) 165.244.149.190

(28) ISO(International Organization for Standardization)

A subsidiary organization of UN establishing and managing the international standards

(29) LAN(Local Area Network)

Called also as local area communication network or district information communication network, which allows lots of computers to exchange data with each other as connected though communication cable within a limited area such as in an office or a building.

(30) MAC(Medium Access Control)

A method used to decide which device should use the network during given time on the broadcast network.

(31) Node

Each computer connected with the network is called Node.

(32) Packet

package of data which is the basic unit used to send through the network. Usually the package is made of several tens or hundreds of bytes with the header attached in front to which its destination and other necessary information are added.

(33) PORT number

Used to classify the applications on TCP/UDP. Ex.) 21/tcp : Telet

(34) PPP(Point-to-Point Protocol)

Phone communication protocol which allows packet transmission in connecting with the Internet. In other words, normal phone cable and modem can be used for the computer to connect through TCP/IP with this most general Internet protocol.

Similar to SLIP, however with modern communication protocol factors such as error detection and data compression, it demonstrates more excellent performance than SLIP.

(35) Protocol

Contains regulations related with mutual information transmission method between computers connected with each other through the network. The protocol may specify detailed interface between machines in Low level (for example, which bit/byte should go out through the line) or high level of message exchange regulations as files are transferred through the Internet.

(36) Reset

This is function used when you want to initialize the communication module to clear the error.

Select [Online] [Reset/clear] [PLC reset] in the XG5000

If you execute this function, PLC will restart

(37) RPI

Abbreviation for Requested Packet Interval, which means to send packet.

(XGT EtherNet / IP module is provided in transmission cycle)

(38) Router

A device used to transfer the data packet between the networks. It sends the data packet to its final destination, waits if the network is congested, or decides which LAN is good to connect to at the LAN junction. Namely, it is a special computer/software used to control the two or more networks connected.

(39) Server

The side which passively responds to the client's request and shares its resources.

(40) Tag

Name tag, in other word named variable.

(41) TCP (Transmission Control Protocol)

A transport layer protocol for the Internet

- Data Tx/Rx through connection

- Multiplexing
- Transmission reliable
- Emergent data transmission supported

(42) TCP/IP (Transmission Control Protocol/Internet Protocol)

Transmission protocol used for communication among different kinds of computers, which makes the communication available between general PC and medium host, IBM PC and MAC, and medium or large-sized different types of computer. It is also used as a general term for information transmission protocol between computer networks including FTP, Telnet, SMTP, etc. TCP divides data into packets to send through IP and the packets sent will be united back together through TCP.

(43) Telnet

It means remote login via Internet. To login to remote host via TELNET, account of that host is necessary. But for some hosts providing public service, you can connect without account.

(44) Token Ring

As short-distance network using Token to connect to network having physical ring structure, one of the Node connection methods at network. If node sending data gets Token, then node gets right to send message packet. Realistically structured examples are IEEE 802.5, ProNet-1080 and FDDI. Terms called Token is used as IEEE 802.5

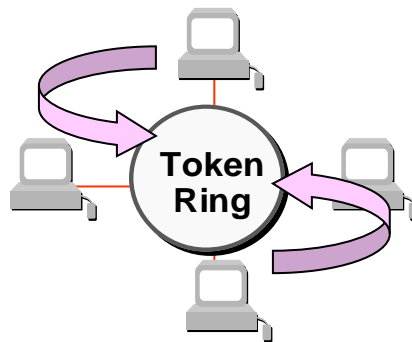

(45) UDP (User Datagram Protocol)

A transport layer protocol for the Internet

- High speed communication because of communication without connection
- Multiplexing
- Lower reliability than TCP in transmission (Tough data doesn't arrive, it doesn't send data again).

(46) Watchdog Timer

It is a function to set the predetermined execution time of the program and to generate an alarm when the processing is not completed within the specified time, indicating that there is an error in the PLC operation.

(47) FDDI (Fiber Distributed Data Interface)

Based on optical cable, provides 100Mbps, Shared Media Network as Dual Ring method, Token Passing is done in two-way. Max 200Km distance for entire network, Max 2Km between Nodes, Max 500 nodes. Generally, this used as Backbone Network.

(48) Ethernet Transceiver

A device designed to connect a computer or electronic device to a network that enables the transmit or transmission of messages.

(49) Media Converter

In most cases, it is a device that acts as a transceiver. It is a device that converts the electrical signal used in the UTP network to the light wavelength used in the optical fiber cable.

(50) Auto crossover: This function detects direct cable / cross cable automatically and connects communication.

(51) Relay: This function is used to send the frame received at the port to the opposite port.

(52) Communication device: It is a term that generally refers to extension driver, Smart I/O expansion and Smart I / O block. It is also used as a communication device.

A.2 List of flags

A.2.1 Special Relay(F) List

Word ^{Note1}	Bit ^{Note2}	type	Variable	Description
F000~1	-	DWORD		Display PLC mode and operation state
-	F0000	BIT	_RUN	RUN Status
-	F0001	BIT	_TEST	STOP Status
-	F0002	BIT	_ERROR	ERROR Status
-	F0006	BIT	_REMOTE_CON	Remote control mode
-	F0012	BIT	_SKIP_ON	I/O skip execution
-	F0013	BIT	_EMASK_ON	Executing fault mask
F002~3	-	DWORD		System Error status
	F0021	BIT	_IO_TYER	Module type mismatch error state
	F0022	BIT	_IO_DEER	Module detachment error status
	F0023	BIT	_FUSE_ER	Fuse cutoff error status
	F0028	BIT	_BPRM_ER	Basic parameter error status
	F0029	BIT	_IOPRM_ER	IO configuration parameter error status
	F002A	BIT	_SPPRM_ER	Parameter error in Characteristics module status
	F002B	BIT	_CPPRM_ER	Parameter error in communication module status
	F002F	BIT	_BASE_POWER_ER	Base power error status
	F0031	BIT	_BASE_INFO_ER	Base information error status
F004~5	-	DWORD		System warning status
	F005D	BIT	_BASE_POWER_WAR	Base power error status
F007		WORD	_CPU_TYPE	Module type information
F008~9		DWORD	_OS_VER	Module version
F010~11		DWORD	_OS_VER_PATCH	Module patch version
F012~13		DWORD	_OS_DATE	OS date
F014		WORD	_REFRESH_MAX	Max. refresh time
F015		WORD	_REFRESH_MIN	Min. refresh time
F016		WORD	_REFRESH_CUR	Current refresh time
F017		WORD	_AC_F_CNT	AC FAIL error count.
F018~19		DWORD	_BASE_EMASK_INFO	Base fault mask information
F020~21		DWORD	_BASE_SKIP_INFO	Base Skip information
F022~029		WORD[0..7]	_SLOT_EMASK_INFO	Slot Fault Mask information
F030~037		WORD[0..7]	_SLOT_SKIP_INFO	Slot Skip information

Word ^{Note1}	Bit ^{Note2}	type	Variable	Description
F038		WORD	_IO_TYER_N	Module type mismatch slot number
F039		WORD	_IO_DEER_N	Module detached slot number
F040		WORD	_FUSE_ER_N	Fuse cutoff slot number
F041		WORD	_IO_RWER_N	Slot number where IO module reading or writing error occurred
F042		WORD	_IP_IFER_N	Slot number where special or communication module reading or writing error occurred
F044~51		WORD[0..7]	_IO_TYERR	Module type mismatch error
F052~59		WORD[0..7]	_IO_DEERR	Module detachment error
F060~67		WORD[0..7]	_FUSE_ERR	Fuse cutoff error
F068~75		WORD[0..7]	_IO_RWERR	IO module reading or writing error
F076~83		WORD[0..7]	_IP_IFERR	Special or communication module reading or writing error
F084~87		DWORD[0..1]	_MEDIA_TOTAL_ERR_CNT	Increase when Media TX/RX error occurs
F088~91		DWORD[0..1]	_MEDIA_TX_ERR_CNT	Increase when Media TX error occurs
F092~95		DWORD[0..1]	_MEDIA_RX_ERR_CNT	Increase when Media TX error occurs
F096~99		DWORD[0..1]	_MEDIA_RX_FCS_ERR_CNT	Increase when CRC(Cyclic Redundancy Check) error occurs during Media TX error
F100~127		WORD[0..7]	_BASE_INFO	Base information
F128		WORD	_SOE_READ_LOG_CNT	Number of SOE events read by the user
F129		WORD	_SOE_READ_LOG_ROTATE	SOE event rotate information read by the user
F130		WORD	_SOE_LOG_CNT	SOE event occurrence count
F131		WORD	_SOE_LOG_ROTATE	SOE event rotate information
F132~133		DWORD	_AC_FAIL_CNT	AC FAIL log count
F134~135		DWORD	_ERR_HIS_CNT	Error log count
F136~137		DWORD	_MOD_HIS_CNT	MOD log count
F138~139		DWORD	_SYS_HIS_CNT	SYSTEM log count
F140~141		DWORD	_LOG_ROTATE	Log rotate information.
F142		WORD	_FLASH_STATE	Flash writing status information
F148~149		DWORD	_CPU_SYS_STATE	System status of CPU
F150~151		DWORD	_CPU_CNF_ER	CPU System Error status
F152~153		DWORD	_CPU_CNF_WAR	CPU System warning status

Note1) The word address is in Fxxx format, where xxx represents a decimal word offset.

Note2) The bit address is in Fxxxxy format, where xxx is the decimal word offset and y is the hexadecimal number of the bit position (0 to F) of the xxx word.

A.3 Special module U Device/Refresh data list

A.3.1 Extension Drive mounting module

(1) XGF-AV8A

1) U Device

Input/output	Variable	type	Device	Comment
Input	XGF-AV8A_ERR	BIT	Uxy.00.0	Analog input module: Module error
Input	XGF-AV8A_RDY	BIT	Uxy.00.F	Analog input module: Module ready
Input	XGF-AV8A_CH0_ACT	BIT	Uxy.01.0	Analog input module: CH0 RUN
Input	XGF-AV8A_CH1_ACT	BIT	Uxy.01.1	Analog input module: CH1 RUN
Input	XGF-AV8A_CH2_ACT	BIT	Uxy.01.2	Analog input module: CH2 RUN
Input	XGF-AV8A_CH3_ACT	BIT	Uxy.01.3	Analog input module: CH3 RUN
Input	XGF-AV8A_CH4_ACT	BIT	Uxy.01.4	Analog input module: CH4 RUN
Input	XGF-AV8A_CH5_ACT	BIT	Uxy.01.5	Analog input module: CH5 RUN
Input	XGF-AV8A_CH6_ACT	BIT	Uxy.01.6	Analog input module: CH6 RUN
Input	XGF-AV8A_CH7_ACT	BIT	Uxy.01.7	Analog input module: CH7 RUN
Input	XGF-AV8A_CH0_IDD	BIT	Uxy.10.0	Analog input module: CH0 input disconnection detection
Input	XGF-AV8A_CH1_IDD	BIT	Uxy.10.1	Analog input module: CH1 input disconnection detection
Input	XGF-AV8A_CH2_IDD	BIT	Uxy.10.2	Analog input module: CH2 input disconnection detection
Input	XGF-AV8A_CH3_IDD	BIT	Uxy.10.3	Analog input module: CH3 input disconnection detection
Input	XGF-AV8A_CH4_IDD	BIT	Uxy.10.4	Analog input module: CH4 input disconnection detection
Input	XGF-AV8A_CH5_IDD	BIT	Uxy.10.5	Analog input module: CH5 input disconnection detection
Input	XGF-AV8A_CH6_IDD	BIT	Uxy.10.6	Analog input module: CH6 input disconnection detection
Input	XGF-AV8A_CH7_IDD	BIT	Uxy.10.7	Analog input module: CH7 input disconnection detection
Output	XGF-AV8A_ERR_CLR	BIT	Uxy.11.0	Analog input module: Error clear request
Input	XGF-AV8A_CH0_HOOR	BIT	Uxy.20.0	Analog input module: Channel 0 upper limit alarm
Input	XGF-AV8A_CH1_HOOR	BIT	Uxy.20.1	Analog input module: Channel 1 upper limit alarm
Input	XGF-AV8A_CH2_HOOR	BIT	Uxy.20.2	Analog input module: Channel 2 upper limit alarm
Input	XGF-AV8A_CH3_HOOR	BIT	Uxy.20.3	Analog input module: Channel 3 upper limit alarm
Input	XGF-AV8A_CH4_HOOR	BIT	Uxy.20.4	Analog input module: Channel 4 upper limit alarm
Input	XGF-AV8A_CH5_HOOR	BIT	Uxy.20.5	Analog input module: Channel 5 upper limit alarm
Input	XGF-AV8A_CH6_HOOR	BIT	Uxy.20.6	Analog input module: Channel 6 upper limit alarm
Input	XGF-AV8A_CH7_HOOR	BIT	Uxy.20.7	Analog input module: Channel 7 upper limit alarm
Input	XGF-AV8A_CH0_LOOR	BIT	Uxy.21.0	Analog input module: Channel 0 lower limit alarm
Input	XGF-AV8A_CH1_LOOR	BIT	Uxy.21.1	Analog input module: Channel 1 lower limit alarm
Input	XGF-AV8A_CH2_LOOR	BIT	Uxy.21.2	Analog input module: Channel 2 lower limit alarm
Input	XGF-AV8A_CH3_LOOR	BIT	Uxy.21.3	Analog input module: Channel 3 lower limit alarm
Input	XGF-AV8A_CH4_LOOR	BIT	Uxy.21.4	Analog input module: Channel 4 lower limit alarm
Input	XGF-AV8A_CH5_LOOR	BIT	Uxy.21.5	Analog input module: Channel 5 lower limit alarm
Input	XGF-AV8A_CH6_LOOR	BIT	Uxy.21.6	Analog input module: Channel 6 lower limit alarm
Input	XGF-AV8A_CH7_LOOR	BIT	Uxy.21.7	Analog input module: Channel 7 lower limit alarm
Input	XGF-AV8A_CH0_DATA	WORD	Uxy.02	Analog input module: CH0 conversion value
Input	XGF-AV8A_CH1_DATA	WORD	Uxy.03	Analog input module: CH1 conversion value
Input	XGF-AV8A_CH2_DATA	WORD	Uxy.04	Analog input module: CH2 conversion value
Input	XGF-AV8A_CH3_DATA	WORD	Uxy.05	Analog input module: CH3 conversion value

Input	XGF-AV8A_CH4_DATA	WORD	Uxy.06	Analog input module: CH4 conversion value
Input	XGF-AV8A_CH5_DATA	WORD	Uxy.07	Analog input module: CH5 conversion value
Input	XGF-AV8A_CH6_DATA	WORD	Uxy.08	Analog input module: CH6 conversion value
Input	XGF-AV8A_CH7_DATA	WORD	Uxy.09	Analog input module: CH7 conversion value

2) Refresh data

<Input>

Input/output	Variable	type	Word(16BIT) Offset	Comment
Input	XGF-AV8A_ERR	BIT	0.0	Analog input module: Module error
Input	XGF-AV8A_RDY	BIT	0.F	Analog input module: Module ready
Input	XGF-AV8A_CH0_ACT	BIT	1.0	Analog input module: CH0 RUN
Input	XGF-AV8A_CH1_ACT	BIT	1.1	Analog input module: CH1 RUN
Input	XGF-AV8A_CH2_ACT	BIT	1.2	Analog input module: CH2 RUN
Input	XGF-AV8A_CH3_ACT	BIT	1.3	Analog input module: CH3 RUN
Input	XGF-AV8A_CH4_ACT	BIT	1.4	Analog input module: CH4 RUN
Input	XGF-AV8A_CH5_ACT	BIT	1.5	Analog input module: CH5 RUN
Input	XGF-AV8A_CH6_ACT	BIT	1.6	Analog input module: CH6 RUN
Input	XGF-AV8A_CH7_ACT	BIT	1.7	Analog input module: CH7 RUN
Input	XGF-AV8A_CH0_DATA	WORD	2	Analog input module: CH0 conversion value
Input	XGF-AV8A_CH1_DATA	WORD	3	Analog input module: CH1 conversion value
Input	XGF-AV8A_CH2_DATA	WORD	4	Analog input module: CH2 conversion value
Input	XGF-AV8A_CH3_DATA	WORD	5	Analog input module: CH3 conversion value
Input	XGF-AV8A_CH4_DATA	WORD	6	Analog input module: CH4 conversion value
Input	XGF-AV8A_CH5_DATA	WORD	7	Analog input module: CH5 conversion value
Input	XGF-AV8A_CH6_DATA	WORD	8	Analog input module: CH6 conversion value
Input	XGF-AV8A_CH7_DATA	WORD	9	Analog input module: CH7 conversion value
Input	XGF-AV8A_CH0_IDD	BIT	10.0	Analog input module: CH0 input disconnection detection
Input	XGF-AV8A_CH1_IDD	BIT	10.1	Analog input module: CH1 input disconnection detection
Input	XGF-AV8A_CH2_IDD	BIT	10.2	Analog input module: CH2 input disconnection detection
Input	XGF-AV8A_CH3_IDD	BIT	10.3	Analog input module: CH3 input disconnection detection
Input	XGF-AV8A_CH4_IDD	BIT	10.4	Analog input module: CH4 input disconnection detection
Input	XGF-AV8A_CH5_IDD	BIT	10.5	Analog input module: CH5 input disconnection detection
Input	XGF-AV8A_CH6_IDD	BIT	10.6	Analog input module: CH6 input disconnection detection
Input	XGF-AV8A_CH7_IDD	BIT	10.7	Analog input module: CH7 input disconnection detection
Input	XGF-AV8A_CH0_HOOR	BIT	11.0	Analog input module: Channel 0 upper limit alarm
Input	XGF-AV8A_CH1_HOOR	BIT	11.1	Analog input module: Channel 1 upper limit alarm
Input	XGF-AV8A_CH2_HOOR	BIT	11.2	Analog input module: Channel 2 upper limit alarm
Input	XGF-AV8A_CH3_HOOR	BIT	11.3	Analog input module: Channel 3 upper limit alarm
Input	XGF-AV8A_CH4_HOOR	BIT	11.4	Analog input module: Channel 4 upper limit alarm
Input	XGF-AV8A_CH5_HOOR	BIT	11.5	Analog input module: Channel 5 upper limit alarm
Input	XGF-AV8A_CH6_HOOR	BIT	11.6	Analog input module: Channel 6 upper limit alarm
Input	XGF-AV8A_CH7_HOOR	BIT	11.7	Analog input module: Channel 7 upper limit alarm
Input	XGF-AV8A_CH0_LOOR	BIT	12.0	Analog input module: Channel 0 lower limit alarm
Input	XGF-AV8A_CH1_LOOR	BIT	12.1	Analog input module: Channel 1 lower limit alarm
Input	XGF-AV8A_CH2_LOOR	BIT	12.2	Analog input module: Channel 2 lower limit alarm
Input	XGF-AV8A_CH3_LOOR	BIT	12.3	Analog input module: Channel 3 lower limit alarm
Input	XGF-AV8A_CH4_LOOR	BIT	12.4	Analog input module: Channel 4 lower limit alarm

Appendix

Input	XGF-AV8A_CH5_LOOR	BIT	12.5	Analog input module: Channel 5 lower limit alarm
Input	XGF-AV8A_CH6_LOOR	BIT	12.6	Analog input module: Channel 6 lower limit alarm
Input	XGF-AV8A_CH7_LOOR	BIT	12.7	Analog input module: Channel 7 lower limit alarm

<Output>

Input/output	Variable	type	Word(16BIT) Offset	Comment
Output	XGF-AV8A_ERR_CLR	BIT	0.0	Analog input module: Error clear request

(2) XGF-AC8A

1) U Device

Input/output	Variable	type	Device	Comment
Input	XGF-AC8A_ERR	BIT	Uxy.00.0	Analog input module: Module error
Input	XGF-AC8A_RDY	BIT	Uxy.00.F	Analog input module: Module ready
Input	XGF-AC8A_CH0_ACT	BIT	Uxy.01.0	Analog input module: CH0 RUN
Input	XGF-AC8A_CH1_ACT	BIT	Uxy.01.1	Analog input module: CH1 RUN
Input	XGF-AC8A_CH2_ACT	BIT	Uxy.01.2	Analog input module: CH2 RUN
Input	XGF-AC8A_CH3_ACT	BIT	Uxy.01.3	Analog input module: CH3 RUN
Input	XGF-AC8A_CH4_ACT	BIT	Uxy.01.4	Analog input module: CH4 RUN
Input	XGF-AC8A_CH5_ACT	BIT	Uxy.01.5	Analog input module: CH5 RUN
Input	XGF-AC8A_CH6_ACT	BIT	Uxy.01.6	Analog input module: CH6 RUN
Input	XGF-AC8A_CH7_ACT	BIT	Uxy.01.7	Analog input module: CH7 RUN
Input	XGF-AC8A_CH0_IDD	BIT	Uxy.10.0	Analog input module: CH0 input disconnection detection
Input	XGF-AC8A_CH1_IDD	BIT	Uxy.10.1	Analog input module: CH1 input disconnection detection
Input	XGF-AC8A_CH2_IDD	BIT	Uxy.10.2	Analog input module: CH2 input disconnection detection
Input	XGF-AC8A_CH3_IDD	BIT	Uxy.10.3	Analog input module: CH3 input disconnection detection
Input	XGF-AC8A_CH4_IDD	BIT	Uxy.10.4	Analog input module: CH4 input disconnection detection
Input	XGF-AC8A_CH5_IDD	BIT	Uxy.10.5	Analog input module: CH5 input disconnection detection
Input	XGF-AC8A_CH6_IDD	BIT	Uxy.10.6	Analog input module: CH6 input disconnection detection
Input	XGF-AC8A_CH7_IDD	BIT	Uxy.10.7	Analog input module: CH7 input disconnection detection
Output	XGF-AC8A_ERR_CLR	BIT	Uxy.11.0	Analog input module: Error clear request
Input	XGF-AC8A_CH0_HOOR	BIT	Uxy.20.0	Analog input module: Channel 0 upper limit alarm
Input	XGF-AC8A_CH1_HOOR	BIT	Uxy.20.1	Analog input module: Channel 1 upper limit alarm
Input	XGF-AC8A_CH2_HOOR	BIT	Uxy.20.2	Analog input module: Channel 2 upper limit alarm
Input	XGF-AC8A_CH3_HOOR	BIT	Uxy.20.3	Analog input module: Channel 3 upper limit alarm
Input	XGF-AC8A_CH4_HOOR	BIT	Uxy.20.4	Analog input module: Channel 4 upper limit alarm
Input	XGF-AC8A_CH5_HOOR	BIT	Uxy.20.5	Analog input module: Channel 5 upper limit alarm
Input	XGF-AC8A_CH6_HOOR	BIT	Uxy.20.6	Analog input module: Channel 6 upper limit alarm
Input	XGF-AC8A_CH7_HOOR	BIT	Uxy.20.7	Analog input module: Channel 7 upper limit alarm
Input	XGF-AC8A_CH0_LOOR	BIT	Uxy.21.0	Analog input module: Channel 0 lower limit alarm
Input	XGF-AC8A_CH1_LOOR	BIT	Uxy.21.1	Analog input module: Channel 1 lower limit alarm
Input	XGF-AC8A_CH2_LOOR	BIT	Uxy.21.2	Analog input module: Channel 2 lower limit alarm
Input	XGF-AC8A_CH3_LOOR	BIT	Uxy.21.3	Analog input module: Channel 3 lower limit alarm
Input	XGF-AC8A_CH4_LOOR	BIT	Uxy.21.4	Analog input module: Channel 4 lower limit alarm
Input	XGF-AC8A_CH5_LOOR	BIT	Uxy.21.5	Analog input module: Channel 5 lower limit alarm
Input	XGF-AC8A_CH6_LOOR	BIT	Uxy.21.6	Analog input module: Channel 6 lower limit alarm
Input	XGF-AC8A_CH7_LOOR	BIT	Uxy.21.7	Analog input module: Channel 7 lower limit alarm

Input	XGF-AC8A_CH0_DATA	WORD	Uxy.02	Analog input module: CH0 conversion value
Input	XGF-AC8A_CH1_DATA	WORD	Uxy.03	Analog input module: CH1 conversion value
Input	XGF-AC8A_CH2_DATA	WORD	Uxy.04	Analog input module: CH2 conversion value
Input	XGF-AC8A_CH3_DATA	WORD	Uxy.05	Analog input module: CH3 conversion value
Input	XGF-AC8A_CH4_DATA	WORD	Uxy.06	Analog input module: CH4 conversion value
Input	XGF-AC8A_CH5_DATA	WORD	Uxy.07	Analog input module: CH5 conversion value
Input	XGF-AC8A_CH6_DATA	WORD	Uxy.08	Analog input module: CH6 conversion value
Input	XGF-AC8A_CH7_DATA	WORD	Uxy.09	Analog input module: CH7 conversion value

2) Refresh data

<Input>

Input/output	Variable	type	Word(16BIT) Offset	Comment
Input	XGF-AC8A_ERR	BIT	0.0	Analog input module: Module error
Input	XGF-AC8A_RDY	BIT	0.F	Analog input module: Module ready
Input	XGF-AC8A_CH0_ACT	BIT	1.0	Analog input module: CH0 RUN
Input	XGF-AC8A_CH1_ACT	BIT	1.1	Analog input module: CH1 RUN
Input	XGF-AC8A_CH2_ACT	BIT	1.2	Analog input module: CH2 RUN
Input	XGF-AC8A_CH3_ACT	BIT	1.3	Analog input module: CH3 RUN
Input	XGF-AC8A_CH4_ACT	BIT	1.4	Analog input module: CH4 RUN
Input	XGF-AC8A_CH5_ACT	BIT	1.5	Analog input module: CH5 RUN
Input	XGF-AC8A_CH6_ACT	BIT	1.6	Analog input module: CH6 RUN
Input	XGF-AC8A_CH7_ACT	BIT	1.7	Analog input module: CH7 RUN
Input	XGF-AC8A_CH0_DATA	WORD	2	Analog input module: CH0 conversion value
Input	XGF-AC8A_CH1_DATA	WORD	3	Analog input module: CH1 conversion value
Input	XGF-AC8A_CH2_DATA	WORD	4	Analog input module: CH2 conversion value
Input	XGF-AC8A_CH3_DATA	WORD	5	Analog input module: CH3 conversion value
Input	XGF-AC8A_CH4_DATA	WORD	6	Analog input module: CH4 conversion value
Input	XGF-AC8A_CH5_DATA	WORD	7	Analog input module: CH5 conversion value
Input	XGF-AC8A_CH6_DATA	WORD	8	Analog input module: CH6 conversion value
Input	XGF-AC8A_CH7_DATA	WORD	9	Analog input module: CH7 conversion value
Input	XGF-AC8A_CH0_IDD	BIT	10.0	Analog input module: CH0 input disconnection detection
Input	XGF-AC8A_CH1_IDD	BIT	10.1	Analog input module: CH1 input disconnection detection
Input	XGF-AC8A_CH2_IDD	BIT	10.2	Analog input module: CH2 input disconnection detection
Input	XGF-AC8A_CH3_IDD	BIT	10.3	Analog input module: CH3 input disconnection detection
Input	XGF-AC8A_CH4_IDD	BIT	10.4	Analog input module: CH4 input disconnection detection
Input	XGF-AC8A_CH5_IDD	BIT	10.5	Analog input module: CH5 input disconnection detection
Input	XGF-AC8A_CH6_IDD	BIT	10.6	Analog input module: CH6 input disconnection detection
Input	XGF-AC8A_CH7_IDD	BIT	10.7	Analog input module: CH7 input disconnection detection
Input	XGF-AC8A_CH0_HOOR	BIT	11.0	Analog input module: Channel 0 upper limit alarm
Input	XGF-AC8A_CH1_HOOR	BIT	11.1	Analog input module: Channel 1 upper limit alarm
Input	XGF-AC8A_CH2_HOOR	BIT	11.2	Analog input module: Channel 2 upper limit alarm
Input	XGF-AC8A_CH3_HOOR	BIT	11.3	Analog input module: Channel 3 upper limit alarm
Input	XGF-AC8A_CH4_HOOR	BIT	11.4	Analog input module: Channel 4 upper limit alarm
Input	XGF-AC8A_CH5_HOOR	BIT	11.5	Analog input module: Channel 5 upper limit alarm
Input	XGF-AC8A_CH6_HOOR	BIT	11.6	Analog input module: Channel 6 upper limit alarm
Input	XGF-AC8A_CH7_HOOR	BIT	11.7	Analog input module: Channel 7 upper limit alarm
Input	XGF-AC8A_CH0_LOOR	BIT	12.0	Analog input module: Channel 0 lower limit alarm

Appendix

Input	XGF-AC8A_CH1_LOOR	BIT	12.1	Analog input module: Channel 1 lower limit alarm
Input	XGF-AC8A_CH2_LOOR	BIT	12.2	Analog input module: Channel 2 lower limit alarm
Input	XGF-AC8A_CH3_LOOR	BIT	12.3	Analog input module: Channel 3 lower limit alarm
Input	XGF-AC8A_CH4_LOOR	BIT	12.4	Analog input module: Channel 4 lower limit alarm
Input	XGF-AC8A_CH5_LOOR	BIT	12.5	Analog input module: Channel 5 lower limit alarm
Input	XGF-AC8A_CH6_LOOR	BIT	12.6	Analog input module: Channel 6 lower limit alarm
Input	XGF-AC8A_CH7_LOOR	BIT	12.7	Analog input module: Channel 7 lower limit alarm

<Output>

Input/output	Variable	type	Word(16BIT) Offset	Comment
Output	XGF-AC8A_ERR_CLR	BIT	0.0	Analog input module: Error clear request

(3) XGF-AD8A

1) U Device

Input/output	Variable	type	Device	Comment
Input	XGF-AD8A_ERR	BIT	Uxy.00.0	Analog input module: Module error
Input	XGF-AD8A_RDY	BIT	Uxy.00.F	Analog input module: Module ready
Input	XGF-AD8A_CH0_ACT	BIT	Uxy.01.0	Analog input module: CH0 RUN
Input	XGF-AD8A_CH1_ACT	BIT	Uxy.01.1	Analog input module: CH1 RUN
Input	XGF-AD8A_CH2_ACT	BIT	Uxy.01.2	Analog input module: CH2 RUN
Input	XGF-AD8A_CH3_ACT	BIT	Uxy.01.3	Analog input module: CH3 RUN
Input	XGF-AD8A_CH4_ACT	BIT	Uxy.01.4	Analog input module: CH4 RUN
Input	XGF-AD8A_CH5_ACT	BIT	Uxy.01.5	Analog input module: CH5 RUN
Input	XGF-AD8A_CH6_ACT	BIT	Uxy.01.6	Analog input module: CH6 RUN
Input	XGF-AD8A_CH7_ACT	BIT	Uxy.01.7	Analog input module: CH7 RUN
Input	XGF-AD8A_CH0_IDD	BIT	Uxy.10.0	Analog input module: CH0 input disconnection detection
Input	XGF-AD8A_CH1_IDD	BIT	Uxy.10.1	Analog input module: CH1 input disconnection detection
Input	XGF-AD8A_CH2_IDD	BIT	Uxy.10.2	Analog input module: CH2 input disconnection detection
Input	XGF-AD8A_CH3_IDD	BIT	Uxy.10.3	Analog input module: CH3 input disconnection detection
Input	XGF-AD8A_CH4_IDD	BIT	Uxy.10.4	Analog input module: CH4 input disconnection detection
Input	XGF-AD8A_CH5_IDD	BIT	Uxy.10.5	Analog input module: CH5 input disconnection detection
Input	XGF-AD8A_CH6_IDD	BIT	Uxy.10.6	Analog input module: CH6 input disconnection detection
Input	XGF-AD8A_CH7_IDD	BIT	Uxy.10.7	Analog input module: CH7 input disconnection detection
Output	XGF-AD8A_ERR_CLR	BIT	Uxy.11.0	Analog input module: Error clear request
Input	XGF-AD8A_CH0_HOOR	BIT	Uxy.20.0	Analog input module: Channel 0 upper limit alarm
Input	XGF-AD8A_CH1_HOOR	BIT	Uxy.20.1	Analog input module: Channel 1 upper limit alarm
Input	XGF-AD8A_CH2_HOOR	BIT	Uxy.20.2	Analog input module: Channel 2 upper limit alarm
Input	XGF-AD8A_CH3_HOOR	BIT	Uxy.20.3	Analog input module: Channel 3 upper limit alarm
Input	XGF-AD8A_CH4_HOOR	BIT	Uxy.20.4	Analog input module: Channel 4 upper limit alarm
Input	XGF-AD8A_CH5_HOOR	BIT	Uxy.20.5	Analog input module: Channel 5 upper limit alarm
Input	XGF-AD8A_CH6_HOOR	BIT	Uxy.20.6	Analog input module: Channel 6 upper limit alarm
Input	XGF-AD8A_CH7_HOOR	BIT	Uxy.20.7	Analog input module: Channel 7 upper limit alarm
Input	XGF-AD8A_CH0_LOOR	BIT	Uxy.21.0	Analog input module: Channel 0 lower limit alarm
Input	XGF-AD8A_CH1_LOOR	BIT	Uxy.21.1	Analog input module: Channel 1 lower limit alarm
Input	XGF-AD8A_CH2_LOOR	BIT	Uxy.21.2	Analog input module: Channel 2 lower limit alarm
Input	XGF-AD8A_CH3_LOOR	BIT	Uxy.21.3	Analog input module: Channel 3 lower limit alarm

Input	XGF-AD8A_CH4_LOOR	BIT	Uxy.21.4	Analog input module: Channel 4 lower limit alarm
Input	XGF-AD8A_CH5_LOOR	BIT	Uxy.21.5	Analog input module: Channel 5 lower limit alarm
Input	XGF-AD8A_CH6_LOOR	BIT	Uxy.21.6	Analog input module: Channel 6 lower limit alarm
Input	XGF-AD8A_CH7_LOOR	BIT	Uxy.21.7	Analog input module: Channel 7 lower limit alarm
Input	XGF-AD8A_CH0_DATA	WORD	Uxy.02	Analog input module: CH0 conversion value
Input	XGF-AD8A_CH1_DATA	WORD	Uxy.03	Analog input module: CH1 conversion value
Input	XGF-AD8A_CH2_DATA	WORD	Uxy.04	Analog input module: CH2 conversion value
Input	XGF-AD8A_CH3_DATA	WORD	Uxy.05	Analog input module: CH3 conversion value
Input	XGF-AD8A_CH4_DATA	WORD	Uxy.06	Analog input module: CH4 conversion value
Input	XGF-AD8A_CH5_DATA	WORD	Uxy.07	Analog input module: CH5 conversion value
Input	XGF-AD8A_CH6_DATA	WORD	Uxy.08	Analog input module: CH6 conversion value
Input	XGF-AD8A_CH7_DATA	WORD	Uxy.09	Analog input module: CH7 conversion value

2) Refresh data

<Input>

Input/Output	Variable	type	Device	Comment
Input	XGF-AD8A_ERR	BIT	0.0	Analog input module: Module error
Input	XGF-AD8A_RDY	BIT	00.F	Analog input module: Module ready
Input	XGF-AD8A_CH0_ACT	BIT	1.0	Analog input module: CH0 RUN
Input	XGF-AD8A_CH1_ACT	BIT	1.1	Analog input module: CH1 RUN
Input	XGF-AD8A_CH2_ACT	BIT	1.2	Analog input module: CH2 RUN
Input	XGF-AD8A_CH3_ACT	BIT	1.3	Analog input module: CH3 RUN
Input	XGF-AD8A_CH4_ACT	BIT	1.4	Analog input module: CH4 RUN
Input	XGF-AD8A_CH5_ACT	BIT	1.5	Analog input module: CH5 RUN
Input	XGF-AD8A_CH6_ACT	BIT	1.6	Analog input module: CH6 RUN
Input	XGF-AD8A_CH7_ACT	BIT	1.7	Analog input module: CH7 RUN
Input	XGF-AD8A_CH0_DATA	WORD	2	Analog input module: CH0 conversion value
Input	XGF-AD8A_CH1_DATA	WORD	3	Analog input module: CH1 conversion value
Input	XGF-AD8A_CH2_DATA	WORD	4	Analog input module: CH2 conversion value
Input	XGF-AD8A_CH3_DATA	WORD	5	Analog input module: CH3 conversion value
Input	XGF-AD8A_CH4_DATA	WORD	6	Analog input module: CH4 conversion value
Input	XGF-AD8A_CH5_DATA	WORD	7	Analog input module: CH5 conversion value
Input	XGF-AD8A_CH6_DATA	WORD	8	Analog input module: CH6 conversion value
Input	XGF-AD8A_CH7_DATA	WORD	9	Analog input module: CH7 conversion value
Input	XGF-AD8A_CH0_IDD	BIT	10.0	Analog input module: CH0 input disconnection detection
Input	XGF-AD8A_CH1_IDD	BIT	10.1	Analog input module: CH1 input disconnection detection
Input	XGF-AD8A_CH2_IDD	BIT	10.2	Analog input module: CH2 input disconnection detection
Input	XGF-AD8A_CH3_IDD	BIT	10.3	Analog input module: CH3 input disconnection detection
Input	XGF-AD8A_CH4_IDD	BIT	10.4	Analog input module: CH4 input disconnection detection
Input	XGF-AD8A_CH5_IDD	BIT	10.5	Analog input module: CH5 input disconnection detection
Input	XGF-AD8A_CH6_IDD	BIT	10.6	Analog input module: CH6 input disconnection detection
Input	XGF-AD8A_CH7_IDD	BIT	10.7	Analog input module: CH7 input disconnection detection
Input	XGF-AD8A_CH0_HOOR	BIT	11.0	Analog input module: Channel 0 upper limit alarm
Input	XGF-AD8A_CH1_HOOR	BIT	11.1	Analog input module: Channel 1 upper limit alarm
Input	XGF-AD8A_CH2_HOOR	BIT	11.2	Analog input module: Channel 2 upper limit alarm
Input	XGF-AD8A_CH3_HOOR	BIT	11.3	Analog input module: Channel 3 upper limit alarm
Input	XGF-AD8A_CH4_HOOR	BIT	11.4	Analog input module: Channel 4 upper limit alarm

Appendix

Input	XGF-AD8A_CH5_HOOR	BIT	11.5	Analog input module: Channel 5 upper limit alarm
Input	XGF-AD8A_CH6_HOOR	BIT	11.6	Analog input module: Channel 6 upper limit alarm
Input	XGF-AD8A_CH7_HOOR	BIT	11.7	Analog input module: Channel 7 upper limit alarm
Input	XGF-AD8A_CH0_LOOR	BIT	12.0	Analog input module: Channel 0 lower limit alarm
Input	XGF-AD8A_CH1_LOOR	BIT	12.1	Analog input module: Channel 1 lower limit alarm
Input	XGF-AD8A_CH2_LOOR	BIT	12.2	Analog input module: Channel 2 lower limit alarm
Input	XGF-AD8A_CH3_LOOR	BIT	12.3	Analog input module: Channel 3 lower limit alarm
Input	XGF-AD8A_CH4_LOOR	BIT	12.4	Analog input module: Channel 4 lower limit alarm
Input	XGF-AD8A_CH5_LOOR	BIT	12.5	Analog input module: Channel 5 lower limit alarm
Input	XGF-AD8A_CH6_LOOR	BIT	12.6	Analog input module: Channel 6 lower limit alarm
Input	XGF-AD8A_CH7_LOOR	BIT	12.7	Analog input module: Channel 7 lower limit alarm

<Output>

Input/output	Variable	type	Device	Comment
Output	XGF-AD8A_ERR_CLR	BIT	0.0	Analog input module: Error clear request

(4) XGF-AD16A

1) U Device

Input/output	Variable	type	Device	Comment
Input	XGF-AD16A_ERR	BIT	Uxy.00.0	Analog input module: Module error
Input	XGF-AD16A_RDY	BIT	Uxy.00.F	Analog input module: Module ready
Input	XGF-AD16A_CH0_ACT	BIT	Uxy.01.0	Analog input module: CH0 RUN
Input	XGF-AD16A_CH1_ACT	BIT	Uxy.01.1	Analog input module: CH1 RUN
Input	XGF-AD16A_CH2_ACT	BIT	Uxy.01.2	Analog input module: CH2 RUN
Input	XGF-AD16A_CH3_ACT	BIT	Uxy.01.3	Analog input module: CH3 RUN
Input	XGF-AD16A_CH4_ACT	BIT	Uxy.01.4	Analog input module: CH4 RUN
Input	XGF-AD16A_CH5_ACT	BIT	Uxy.01.5	Analog input module: CH5 RUN
Input	XGF-AD16A_CH6_ACT	BIT	Uxy.01.6	Analog input module: CH6 RUN
Input	XGF-AD16A_CH7_ACT	BIT	Uxy.01.7	Analog input module: CH7 RUN
Input	XGF-AD16A_CH8_ACT	BIT	Uxy.01.8	Analog input module: CH8 RUN
Input	XGF-AD16A_CH9_ACT	BIT	Uxy.01.9	Analog input module: CH9 RUN
Input	XGF-AD16A_CH10_ACT	BIT	Uxy.01.A	Analog input module: CH10 RUN
Input	XGF-AD16A_CH11_ACT	BIT	Uxy.01.B	Analog input module: CH11 RUN
Input	XGF-AD16A_CH12_ACT	BIT	Uxy.01.C	Analog input module: CH12 RUN
Input	XGF-AD16A_CH13_ACT	BIT	Uxy.01.D	Analog input module: CH13 RUN
Input	XGF-AD16A_CH14_ACT	BIT	Uxy.01.E	Analog input module: CH14 RUN
Input	XGF-AD16A_CH15_ACT	BIT	Uxy.01.F	Analog input module: CH15 RUN
Input	XGF-AD16A_CH0_DATA	WORD	Uxy.02	Analog input module: CH0 conversion value
Input	XGF-AD16A_CH1_DATA	WORD	Uxy.03	Analog input module: CH1 conversion value
Input	XGF-AD16A_CH2_DATA	WORD	Uxy.04	Analog input module: CH2 conversion value
Input	XGF-AD16A_CH3_DATA	WORD	Uxy.05	Analog input module: CH3 conversion value
Input	XGF-AD16A_CH4_DATA	WORD	Uxy.06	Analog input module: CH4 conversion value
Input	XGF-AD16A_CH5_DATA	WORD	Uxy.07	Analog input module: CH5 conversion value
Input	XGF-AD16A_CH6_DATA	WORD	Uxy.08	Analog input module: CH6 conversion value
Input	XGF-AD16A_CH7_DATA	WORD	Uxy.09	Analog input module: CH7 conversion value
Input	XGF-AD16A_CH8_DATA	WORD	Uxy.10	Analog input module: CH8 conversion value

Input	XGF-AD16A_CH9_DATA	WORD	Uxy.11	Analog input module: CH9 conversion value
Input	XGF-AD16A_CH10_DATA	WORD	Uxy.12	Analog input module: CH10 conversion value
Input	XGF-AD16A_CH11_DATA	WORD	Uxy.13	Analog input module: CH11 conversion value
Input	XGF-AD16A_CH12_DATA	WORD	Uxy.14	Analog input module: CH12 conversion value
Input	XGF-AD16A_CH13_DATA	WORD	Uxy.15	Analog input module: CH13 conversion value
Input	XGF-AD16A_CH14_DATA	WORD	Uxy.16	Analog input module: CH14 conversion value
Input	XGF-AD16A_CH15_DATA	WORD	Uxy.17	Analog input module: CH15 conversion value
Input	XGF-AD16A_CH0_IDD	BIT	Uxy.18.0	Analog input module: CH0 input disconnection detection
Input	XGF-AD16A_CH1_IDD	BIT	Uxy.18.1	Analog input module: CH1 input disconnection detection
Input	XGF-AD16A_CH2_IDD	BIT	Uxy.18.2	Analog input module: CH2 input disconnection detection
Input	XGF-AD16A_CH3_IDD	BIT	Uxy.18.3	Analog input module: CH3 input disconnection detection
Input	XGF-AD16A_CH4_IDD	BIT	Uxy.18.4	Analog input module: CH4 input disconnection detection
Input	XGF-AD16A_CH5_IDD	BIT	Uxy.18.5	Analog input module: CH5 input disconnection detection
Input	XGF-AD16A_CH6_IDD	BIT	Uxy.18.6	Analog input module: CH6 input disconnection detection
Input	XGF-AD16A_CH7_IDD	BIT	Uxy.18.7	Analog input module: CH7 input disconnection detection
Input	XGF-AD16A_CH8_IDD	BIT	Uxy.18.8	Analog input module: CH8 input disconnection detection
Input	XGF-AD16A_CH9_IDD	BIT	Uxy.18.9	Analog input module: CH9 input disconnection detection
Input	XGF-AD16A_CH10_IDD	BIT	Uxy.18.A	Analog input module: CH10 input disconnection detection
Input	XGF-AD16A_CH11_IDD	BIT	Uxy.18.B	Analog input module: CH11 input disconnection detection
Input	XGF-AD16A_CH12_IDD	BIT	Uxy.18.C	Analog input module: CH12 input disconnection detection
Input	XGF-AD16A_CH13_IDD	BIT	Uxy.18.D	Analog input module: CH13 input disconnection detection
Input	XGF-AD16A_CH14_IDD	BIT	Uxy.18.E	Analog input module: CH14 input disconnection detection
Input	XGF-AD16A_CH15_IDD	BIT	Uxy.18.F	Analog input module: CH15 input disconnection detection
Input	XGF-AD16A_ERR_CLR	BIT	Uxy.19.0	Analog input module: Error clear request (Reserved)
Input	XGF-AD16A_CH0_HOOR	BIT	Uxy.20.0	Analog input module: Channel 0 upper limit alarm
Input	XGF-AD16A_CH1_HOOR	BIT	Uxy.20.1	Analog input module: Channel 1 upper limit alarm
Input	XGF-AD16A_CH2_HOOR	BIT	Uxy.20.2	Analog input module: Channel 2 upper limit alarm
Input	XGF-AD16A_CH3_HOOR	BIT	Uxy.20.3	Analog input module: Channel 3 upper limit alarm
Input	XGF-AD16A_CH4_HOOR	BIT	Uxy.20.4	Analog input module: Channel 4 upper limit alarm
Input	XGF-AD16A_CH5_HOOR	BIT	Uxy.20.5	Analog input module: Channel 5 upper limit alarm
Input	XGF-AD16A_CH6_HOOR	BIT	Uxy.20.6	Analog input module: Channel 6 upper limit alarm
Input	XGF-AD16A_CH7_HOOR	BIT	Uxy.20.7	Analog input module: Channel 7 upper limit alarm
Input	XGF-AD16A_CH8_HOOR	BIT	Uxy.20.8	Analog input module: Channel 8 upper limit alarm
Input	XGF-AD16A_CH9_HOOR	BIT	Uxy.20.9	Analog input module: Channel 9 upper limit alarm
Input	XGF-AD16A_CH10_HOOR	BIT	Uxy.20.A	Analog input module: Channel 10 upper limit alarm
Input	XGF-AD16A_CH11_HOOR	BIT	Uxy.20.B	Analog input module: Channel 11 upper limit alarm
Input	XGF-AD16A_CH12_HOOR	BIT	Uxy.20.C	Analog input module: Channel 12 upper limit alarm
Input	XGF-AD16A_CH13_HOOR	BIT	Uxy.20.D	Analog input module: Channel 13 upper limit alarm
Input	XGF-AD16A_CH14_HOOR	BIT	Uxy.20.E	Analog input module: Channel 14 upper limit alarm
Input	XGF-AD16A_CH15_HOOR	BIT	Uxy.20.F	Analog input module: Channel 15 upper limit alarm
Input	XGF-AD16A_CH0_LOOR	BIT	Uxy.21.0	Analog input module: Channel 0 lower limit alarm
Input	XGF-AD16A_CH1_LOOR	BIT	Uxy.21.1	Analog input module: Channel 1 lower limit alarm
Input	XGF-AD16A_CH2_LOOR	BIT	Uxy.21.2	Analog input module: Channel 2 lower limit alarm
Input	XGF-AD16A_CH3_LOOR	BIT	Uxy.21.3	Analog input module: Channel 3 lower limit alarm
Input	XGF-AD16A_CH4_LOOR	BIT	Uxy.21.4	Analog input module: Channel 4 lower limit alarm
Input	XGF-AD16A_CH5_LOOR	BIT	Uxy.21.5	Analog input module: Channel 5 lower limit alarm
Input	XGF-AD16A_CH6_LOOR	BIT	Uxy.21.6	Analog input module: Channel 6 lower limit alarm

Appendix

Input	XGF-AD16A_CH7_LOOR	BIT	Uxy.21.7	Analog input module: Channel 7 lower limit alarm
Input	XGF-AD16A_CH8_LOOR	BIT	Uxy.21.8	Analog input module: Channel 8 lower limit alarm
Input	XGF-AD16A_CH9_LOOR	BIT	Uxy.21.9	Analog input module: Channel 9 lower limit alarm
Input	XGF-AD16A_CH10_LOOR	BIT	Uxy.21.A	Analog input module: Channel 10 lower limit alarm
Input	XGF-AD16A_CH11_LOOR	BIT	Uxy.21.B	Analog input module: Channel 11 lower limit alarm
Input	XGF-AD16A_CH12_LOOR	BIT	Uxy.21.C	Analog input module: Channel 12 lower limit alarm
Input	XGF-AD16A_CH13_LOOR	BIT	Uxy.21.D	Analog input module: Channel 13 lower limit alarm
Input	XGF-AD16A_CH14_LOOR	BIT	Uxy.21.E	Analog input module: Channel 14 lower limit alarm
Input	XGF-AD16A_CH15_LOOR	BIT	Uxy.21.F	Analog input module: Channel 15 lower limit alarm
Output	XGF-AD16A_ERR_CRT	BIT	Uxy.22.0	Analog input module: Error clear request (V1.02)

2) Refresh data

<Input>

Input/output	Variable	type	Word(16BIT) Offset	Comment
Input	XGF-AD16A_ERR	BIT	0.0	Analog input module: Module error
Input	XGF-AD16A_RDY	BIT	0.F	Analog input module: Module ready
Input	XGF-AD16A_CH0_ACT	BIT	1.0	Analog input module: CH0 RUN
Input	XGF-AD16A_CH1_ACT	BIT	1.1	Analog input module: CH1 RUN
Input	XGF-AD16A_CH2_ACT	BIT	1.2	Analog input module: CH2 RUN
Input	XGF-AD16A_CH3_ACT	BIT	1.3	Analog input module: CH3 RUN
Input	XGF-AD16A_CH4_ACT	BIT	1.4	Analog input module: CH4 RUN
Input	XGF-AD16A_CH5_ACT	BIT	1.5	Analog input module: CH5 RUN
Input	XGF-AD16A_CH6_ACT	BIT	1.6	Analog input module: CH6 RUN
Input	XGF-AD16A_CH7_ACT	BIT	1.7	Analog input module: CH7 RUN
Input	XGF-AD16A_CH8_ACT	BIT	1.8	Analog input module: CH8 RUN
Input	XGF-AD16A_CH9_ACT	BIT	1.9	Analog input module: CH9 RUN
Input	XGF-AD16A_CH10_ACT	BIT	1.A	Analog input module: CH10 RUN
Input	XGF-AD16A_CH11_ACT	BIT	1.B	Analog input module: CH11 RUN
Input	XGF-AD16A_CH12_ACT	BIT	1.C	Analog input module: CH12 RUN
Input	XGF-AD16A_CH13_ACT	BIT	1.D	Analog input module: CH13 RUN
Input	XGF-AD16A_CH14_ACT	BIT	1.E	Analog input module: CH14 RUN
Input	XGF-AD16A_CH15_ACT	BIT	1.F	Analog input module: CH15 RUN
Input	XGF-AD16A_CH0_DATA	WORD	2	Analog input module: CH0 conversion value
Input	XGF-AD16A_CH1_DATA	WORD	3	Analog input module: CH1 conversion value
Input	XGF-AD16A_CH2_DATA	WORD	4	Analog input module: CH2 conversion value
Input	XGF-AD16A_CH3_DATA	WORD	5	Analog input module: CH3 conversion value
Input	XGF-AD16A_CH4_DATA	WORD	6	Analog input module: CH4 conversion value
Input	XGF-AD16A_CH5_DATA	WORD	7	Analog input module: CH5 conversion value
Input	XGF-AD16A_CH6_DATA	WORD	8	Analog input module: CH6 conversion value
Input	XGF-AD16A_CH7_DATA	WORD	9	Analog input module: CH7 conversion value
Input	XGF-AD16A_CH8_DATA	WORD	10	Analog input module: CH8 conversion value
Input	XGF-AD16A_CH9_DATA	WORD	11	Analog input module: CH9 conversion value
Input	XGF-AD16A_CH10_DATA	WORD	12	Analog input module: CH10 conversion value
Input	XGF-AD16A_CH11_DATA	WORD	13	Analog input module: CH11 conversion value
Input	XGF-AD16A_CH12_DATA	WORD	14	Analog input module: CH12 conversion value
Input	XGF-AD16A_CH13_DATA	WORD	15	Analog input module: CH13 conversion value
Input	XGF-AD16A_CH14_DATA	WORD	16	Analog input module: CH14 conversion value

Input	XGF-AD16A_CH15_DATA	WORD	17	Analog input module: CH15 conversion value
Input	XGF-AD16A_CH0_IDD	BIT	18.0	Analog input module: CH0 input disconnection detection
Input	XGF-AD16A_CH1_IDD	BIT	18.1	Analog input module: CH1 input disconnection detection
Input	XGF-AD16A_CH2_IDD	BIT	18.2	Analog input module: CH2 input disconnection detection
Input	XGF-AD16A_CH3_IDD	BIT	18.3	Analog input module: CH3 input disconnection detection
Input	XGF-AD16A_CH4_IDD	BIT	18.4	Analog input module: CH4 input disconnection detection
Input	XGF-AD16A_CH5_IDD	BIT	18.5	Analog input module: CH5 input disconnection detection
Input	XGF-AD16A_CH6_IDD	BIT	18.6	Analog input module: CH6 input disconnection detection
Input	XGF-AD16A_CH7_IDD	BIT	18.7	Analog input module: CH7 input disconnection detection
Input	XGF-AD16A_CH8_IDD	BIT	18.8	Analog input module: CH8 input disconnection detection
Input	XGF-AD16A_CH9_IDD	BIT	18.9	Analog input module: CH9 input disconnection detection
Input	XGF-AD16A_CH10_IDD	BIT	18.A	Analog input module: CH10 input disconnection detection
Input	XGF-AD16A_CH11_IDD	BIT	18.B	Analog input module: CH11 input disconnection detection
Input	XGF-AD16A_CH12_IDD	BIT	18.C	Analog input module: CH12 input disconnection detection
Input	XGF-AD16A_CH13_IDD	BIT	18.D	Analog input module: CH13 input disconnection detection
Input	XGF-AD16A_CH14_IDD	BIT	18.E	Analog input module: CH14 input disconnection detection
Input	XGF-AD16A_CH15_IDD	BIT	18.F	Analog input module: CH15 input disconnection detection
Input	XGF-AD16A_ERR_CLR	BIT	19.0	Analog input module: Error clear request (Reserved)
Input	XGF-AD16A_CH0_HOOR	BIT	20.0	Analog input module: Channel 0 upper limit alarm
Input	XGF-AD16A_CH1_HOOR	BIT	20.1	Analog input module: Channel 1 upper limit alarm
Input	XGF-AD16A_CH2_HOOR	BIT	20.2	Analog input module: Channel 2 upper limit alarm
Input	XGF-AD16A_CH3_HOOR	BIT	20.3	Analog input module: Channel 3 upper limit alarm
Input	XGF-AD16A_CH4_HOOR	BIT	20.4	Analog input module: Channel 4 upper limit alarm
Input	XGF-AD16A_CH5_HOOR	BIT	20.5	Analog input module: Channel 5 upper limit alarm
Input	XGF-AD16A_CH6_HOOR	BIT	20.6	Analog input module: Channel 6 upper limit alarm
Input	XGF-AD16A_CH7_HOOR	BIT	20.7	Analog input module: Channel 7 upper limit alarm
Input	XGF-AD16A_CH8_HOOR	BIT	20.8	Analog input module: Channel 8 upper limit alarm
Input	XGF-AD16A_CH9_HOOR	BIT	20.9	Analog input module: Channel 9 upper limit alarm
Input	XGF-AD16A_CH10_HOOR	BIT	20.A	Analog input module: Channel 10 upper limit alarm
Input	XGF-AD16A_CH11_HOOR	BIT	20.B	Analog input module: Channel 11 upper limit alarm
Input	XGF-AD16A_CH12_HOOR	BIT	20.C	Analog input module: Channel 12 upper limit alarm
Input	XGF-AD16A_CH13_HOOR	BIT	20.D	Analog input module: Channel 13 upper limit alarm
Input	XGF-AD16A_CH14_HOOR	BIT	20.E	Analog input module: Channel 14 upper limit alarm
Input	XGF-AD16A_CH15_HOOR	BIT	20.F	Analog input module: Channel 15 upper limit alarm
Input	XGF-AD16A_CH0_LOOR	BIT	21.0	Analog input module: Channel 0 lower limit alarm
Input	XGF-AD16A_CH1_LOOR	BIT	21.1	Analog input module: Channel 1 lower limit alarm
Input	XGF-AD16A_CH2_LOOR	BIT	21.2	Analog input module: Channel 2 lower limit alarm
Input	XGF-AD16A_CH3_LOOR	BIT	21.3	Analog input module: Channel 3 lower limit alarm
Input	XGF-AD16A_CH4_LOOR	BIT	21.4	Analog input module: Channel 4 lower limit alarm
Input	XGF-AD16A_CH5_LOOR	BIT	21.5	Analog input module: Channel 5 lower limit alarm
Input	XGF-AD16A_CH6_LOOR	BIT	21.6	Analog input module: Channel 6 lower limit alarm
Input	XGF-AD16A_CH7_LOOR	BIT	21.7	Analog input module: Channel 7 lower limit alarm
Input	XGF-AD16A_CH8_LOOR	BIT	21.8	Analog input module: Channel 8 lower limit alarm
Input	XGF-AD16A_CH9_LOOR	BIT	21.9	Analog input module: Channel 9 lower limit alarm
Input	XGF-AD16A_CH10_LOOR	BIT	21.A	Analog input module: Channel 10 lower limit alarm
Input	XGF-AD16A_CH11_LOOR	BIT	21.B	Analog input module: Channel 11 lower limit alarm
Input	XGF-AD16A_CH12_LOOR	BIT	21.C	Analog input module: Channel 12 lower limit alarm
Input	XGF-AD16A_CH13_LOOR	BIT	21.D	Analog input module: Channel 13 lower limit alarm
Input	XGF-AD16A_CH14_LOOR	BIT	21.E	Analog input module: Channel 14 lower limit alarm

Appendix

Input	XGF-AD16A_CH15_LOOR	BIT	21.F	Analog input module: Channel 15 lower limit alarm
-------	---------------------	-----	------	---

<Output>

Input/output	Variable	type	Word(16BIT) Offset	Comment
Output	XGF-AD16A_ERR_CRT	BIT	0.0	Analog input module: Error clear request (V1.02)

(5) XGF-AD4S

1) U Device

Input/output	Variable	type	Device	Comment
Input	XGF-AD4S_ERR	BIT	Uxy.00.0	Isolated Analog input module: Module error
Input	XGF-AD4S_RDY	BIT	Uxy.00.F	Isolated Analog input module: Module ready
Input	XGF-AD4S_CH0_ACT	BIT	Uxy.01.0	Isolated Analog input module: CH0 RUN
Input	XGF-AD4S_CH1_ACT	BIT	Uxy.01.1	Isolated Analog input module: CH1 RUN
Input	XGF-AD4S_CH2_ACT	BIT	Uxy.01.2	Isolated Analog input module: CH2 RUN
Input	XGF-AD4S_CH3_ACT	BIT	Uxy.01.3	Isolated Analog input module: CH3 RUN
Input	XGF-AD4S_CH0_DATA	WORD	Uxy.02	Isolated Analog input module: CH0 conversion value
Input	XGF-AD4S_CH1_DATA	WORD	Uxy.03	Isolated Analog input module: CH1 conversion value
Input	XGF-AD4S_CH2_DATA	WORD	Uxy.04	Isolated Analog input module: CH2 conversion value
Input	XGF-AD4S_CH3_DATA	WORD	Uxy.05	Isolated Analog input module: CH3 conversion value
Input	XGF-AD4S_CH0_PAHH	BIT	Uxy.08.0	Isolated Analog input module: CH0 process alarm HH
Input	XGF-AD4S_CH0_PAH	BIT	Uxy.08.1	Isolated Analog input module: CH0 process alarm H
Input	XGF-AD4S_CH0_PAL	BIT	Uxy.08.2	Isolated Analog input module: CH0 process alarm lower limit
Input	XGF-AD4S_CH0_PALL	BIT	Uxy.08.3	Isolated Analog input module: CH0 process alarm LL
Input	XGF-AD4S_CH1_PAHH	BIT	Uxy.08.4	Isolated Analog input module: CH1 process alarm HH
Input	XGF-AD4S_CH1_PAH	BIT	Uxy.08.5	Isolated Analog input module: CH1 process alarm H
Input	XGF-AD4S_CH1_PAL	BIT	Uxy.08.6	Isolated Analog input module: CH1 process alarm lower limit
Input	XGF-AD4S_CH1_PALL	BIT	Uxy.08.7	Isolated Analog input module: CH1 process alarm LL
Input	XGF-AD4S_CH2_PAHH	BIT	Uxy.08.8	Isolated Analog input module: CH2 process alarm HH
Input	XGF-AD4S_CH2_PAH	BIT	Uxy.08.9	Isolated Analog input module: CH2 process alarm H
Input	XGF-AD4S_CH2_PAL	BIT	Uxy.08.A	Isolated Analog input module: CH2 process alarm lower limit
Input	XGF-AD4S_CH2_PALL	BIT	Uxy.08.B	Isolated Analog input module: CH2 process alarm LL
Input	XGF-AD4S_CH3_PAHH	BIT	Uxy.08.C	Isolated Analog input module: CH3 process alarm HH
Input	XGF-AD4S_CH3_PAH	BIT	Uxy.08.D	Isolated Analog input module: CH3 process alarm H
Input	XGF-AD4S_CH3_PAL	BIT	Uxy.08.E	Isolated Analog input module: CH3 process alarm lower limit
Input	XGF-AD4S_CH3_PALL	BIT	Uxy.08.F	Isolated Analog input module: CH3 process alarm LL
Input	XGF-AD4S_CH0_RAHH	BIT	Uxy.09.0	Isolated Analog input module: CH0 Rate Alarm High limit
Input	XGF-AD4S_CH0_RAL	BIT	Uxy.09.1	Isolated Analog input module: CH0 Rate Alarm Lower limit
Input	XGF-AD4S_CH1_RAHH	BIT	Uxy.09.2	Isolated Analog input module: CH1 Rate Alarm High limit
Input	XGF-AD4S_CH1_RAL	BIT	Uxy.09.3	Isolated Analog input module: CH1 Rate Alarm Lower limit
Input	XGF-AD4S_CH2_RAHH	BIT	Uxy.09.4	Isolated Analog input module: CH2 Rate Alarm High limit
Input	XGF-AD4S_CH2_RAL	BIT	Uxy.09.5	Isolated Analog input module: CH2 Rate Alarm Lower limit

Input	XGF-AD4S_CH3_RAHH	BIT	Uxy.09.6	Isolated Analog input module: CH3 Rate Alarm High limit
Input	XGF-AD4S_CH3_RAL	BIT	Uxy.09.7	Isolated Analog input module: CH3 Rate Alarm Lower limit
Input	XGF-AD4S_CH0_IDD	BIT	Uxy.10.0	Isolated Analog input module: CH0 input disconnection detection
Input	XGF-AD4S_CH1_IDD	BIT	Uxy.10.1	Isolated Analog input module: CH1 input disconnection detection
Input	XGF-AD4S_CH2_IDD	BIT	Uxy.10.2	Isolated Analog input module: CH2 input disconnection detection
Input	XGF-AD4S_CH3_IDD	BIT	Uxy.10.3	Isolated Analog input module: CH3 input disconnection detection
Output	XGF-AD4S_ERR_CLR	BIT	Uxy.11.0	Isolated Analog input module: Error clear request

2) Refresh data

<Input>

Input/output	Variable	type	Word(16BIT) Offset	Comment
Input	XGF-AD4S_ERR	BIT	0.0	Isolated Analog input module: Module error
Input	XGF-AD4S_RDY	BIT	0.F	Isolated Analog input module: Module ready
Input	XGF-AD4S_CH0_ACT	BIT	1.0	Isolated Analog input module: CH0 RUN
Input	XGF-AD4S_CH1_ACT	BIT	1.1	Isolated Analog input module: CH1 RUN
Input	XGF-AD4S_CH2_ACT	BIT	1.2	Isolated Analog input module: CH2 RUN
Input	XGF-AD4S_CH3_ACT	BIT	1.3	Isolated Analog input module: CH3 RUN
Input	XGF-AD4S_CH0_DATA	WORD	2	Isolated Analog input module: CH0 conversion value
Input	XGF-AD4S_CH1_DATA	WORD	3	Isolated Analog input module: CH1 conversion value
Input	XGF-AD4S_CH2_DATA	WORD	4	Isolated Analog input module: CH2 conversion value
Input	XGF-AD4S_CH3_DATA	WORD	5	Isolated Analog input module: CH3 conversion value
Input		WORD	6	Reserved
Input		WORD	7	Reserved
Input	XGF-AD4S_CH0_PAHH	BIT	8.0	Isolated Analog input module: CH0 process alarm HH
Input	XGF-AD4S_CH0_PAH	BIT	8.1	Isolated Analog input module: CH0 process alarm H
Input	XGF-AD4S_CH0_PAL	BIT	8.2	Isolated Analog input module: CH0 process alarm lower limit
Input	XGF-AD4S_CH0_PALL	BIT	8.3	Isolated Analog input module: CH0 process alarm LL
Input	XGF-AD4S_CH1_PAHH	BIT	8.4	Isolated Analog input module: CH1 process alarm HH
Input	XGF-AD4S_CH1_PAH	BIT	8.5	Isolated Analog input module: CH1 process alarm H
Input	XGF-AD4S_CH1_PAL	BIT	8.6	Isolated Analog input module: CH1 process alarm lower limit
Input	XGF-AD4S_CH1_PALL	BIT	8.7	Isolated Analog input module: CH1 process alarm LL
Input	XGF-AD4S_CH2_PAHH	BIT	8.8	Isolated Analog input module: CH2 process alarm HH
Input	XGF-AD4S_CH2_PAH	BIT	8.9	Isolated Analog input module: CH2 process alarm H
Input	XGF-AD4S_CH2_PAL	BIT	8.A	Isolated Analog input module: CH2 process alarm lower limit
Input	XGF-AD4S_CH2_PALL	BIT	8.B	Isolated Analog input module: CH2 process alarm LL
Input	XGF-AD4S_CH3_PAHH	BIT	8.C	Isolated Analog input module: CH3 process alarm HH
Input	XGF-AD4S_CH3_PAH	BIT	8.D	Isolated Analog input module: CH3 process alarm H
Input	XGF-AD4S_CH3_PAL	BIT	8.E	Isolated Analog input module: CH3 process alarm lower limit
Input	XGF-AD4S_CH3_PALL	BIT	8.F	Isolated Analog input module: CH3 process alarm LL
Input	XGF-AD4S_CH0_RAHH	BIT	9.0	Isolated Analog input module: CH0 Rate Alarm High limit
Input	XGF-AD4S_CH0_RAL	BIT	9.1	Isolated Analog input module: CH0 Rate Alarm Lower limit
Input	XGF-AD4S_CH1_RAHH	BIT	9.2	Isolated Analog input module: CH1 Rate Alarm High limit
Input	XGF-AD4S_CH1_RAL	BIT	9.3	Isolated Analog input module: CH1 Rate Alarm Lower limit
Input	XGF-AD4S_CH2_RAHH	BIT	9.4	Isolated Analog input module: CH2 Rate Alarm High limit
Input	XGF-AD4S_CH2_RAL	BIT	9.5	Isolated Analog input module: CH2 Rate Alarm Lower limit
Input	XGF-AD4S_CH3_RAHH	BIT	9.6	Isolated Analog input module: CH3 Rate Alarm High limit

Appendix

Input	XGF-AD4S_CH3_RAL	BIT	9.7	Isolated Analog input module: CH3 Rate Alarm Lower limit
Input	XGF-AD4S_CH0_IDD	BIT	10.0	Isolated Analog input module: CH0 input disconnection detection
Input	XGF-AD4S_CH1_IDD	BIT	10.1	Isolated Analog input module: CH1 input disconnection detection
Input	XGF-AD4S_CH2_IDD	BIT	10.2	Isolated Analog input module: CH2 input disconnection detection
Input	XGF-AD4S_CH3_IDD	BIT	10.3	Isolated Analog input module: CH3 input disconnection detection

<Output>

Input/output	Variable	type	Word(16BIT) Offset	Comment
Output	XGF-AD4S_ERR_CLR	BIT	0.0	Isolated Analog input module: Error clear request

(6) XGF-AW4S

1) U Device

Input/output	Variable	type	Device	Comment
Input	XGF-AW4SERR	BIT	Uxy.00.0	2-Wire Analog Input Module: Module error
Input	XGF-AW4SRDY	BIT	Uxy.00.F	2-Wire Analog Input Module: Module ready
Input	XGF-AW4SCH0_ACT	BIT	Uxy.01.0	2-Wire Analog Input Module: CH0 RUN
Input	XGF-AW4SCH1_ACT	BIT	Uxy.01.1	2-Wire Analog Input Module: CH1 RUN
Input	XGF-AW4SCH2_ACT	BIT	Uxy.01.2	2-Wire Analog Input Module: CH2 RUN
Input	XGF-AW4SCH3_ACT	BIT	Uxy.01.3	2-Wire Analog Input Module: CH3 RUN
Input	XGF-AW4SCH0_DATA	WORD	Uxy.02	2-Wire Analog Input Module: CH0 conversion value
Input	XGF-AW4SCH1_DATA	WORD	Uxy.03	2-Wire Analog Input Module: CH1 conversion value
Input	XGF-AW4SCH2_DATA	WORD	Uxy.04	2-Wire Analog Input Module: CH2 conversion value
Input	XGF-AW4SCH3_DATA	WORD	Uxy.05	2-Wire Analog Input Module: CH3 conversion value
Input	XGF-AW4SCH0_PALL	BIT	Uxy.08.0	2-Wire Analog Input Module: CH0 process alarm LL
Input	XGF-AW4SCH0_PAL	BIT	Uxy.08.1	2-Wire Analog Input Module: CH0 process alarm lower limit
Input	XGF-AW4SCH0_PAH	BIT	Uxy.08.2	2-Wire Analog Input Module: CH0 process alarm H
Input	XGF-AW4SCH0_PAHH	BIT	Uxy.08.3	2-Wire Analog Input Module: CH0 process alarm HH
Input	XGF-AW4SCH1_PALL	BIT	Uxy.08.4	2-Wire Analog Input Module: CH1 process alarm LL
Input	XGF-AW4SCH1_PAL	BIT	Uxy.08.5	2-Wire Analog Input Module: CH1 process alarm lower limit
Input	XGF-AW4SCH1_PAH	BIT	Uxy.08.6	2-Wire Analog Input Module: CH1 process alarm H
Input	XGF-AW4SCH1_PAHH	BIT	Uxy.08.7	2-Wire Analog Input Module: CH1 process alarm HH
Input	XGF-AW4SCH2_PALL	BIT	Uxy.08.8	2-Wire Analog Input Module: CH2 process alarm LL
Input	XGF-AW4SCH2_PAL	BIT	Uxy.08.9	2-Wire Analog Input Module: CH2 process alarm lower limit
Input	XGF-AW4SCH2_PAH	BIT	Uxy.08.A	2-Wire Analog Input Module: CH2 process alarm H
Input	XGF-AW4SCH2_PAHH	BIT	Uxy.08.B	2-Wire Analog Input Module: CH2 process alarm HH
Input	XGF-AW4SCH3_PALL	BIT	Uxy.08.C	2-Wire Analog Input Module: CH3 process alarm LL
Input	XGF-AW4SCH3_PAL	BIT	Uxy.08.D	2-Wire Analog Input Module: CH3 process alarm lower limit
Input	XGF-AW4SCH3_PAH	BIT	Uxy.08.E	2-Wire Analog Input Module: CH3 process alarm H
Input	XGF-AW4SCH3_PAHH	BIT	Uxy.08.F	2-Wire Analog Input Module: CH3 process alarm HH
Input	XGF-AW4SCH0_RAL	BIT	Uxy.09.0	2-Wire Analog Input Module: CH0 Rate Alarm Lower limit
Input	XGF-AW4SCH0_RAH	BIT	Uxy.09.1	2-Wire Analog Input Module: CH0 Rate Alarm High limit
Input	XGF-AW4SCH1_RAL	BIT	Uxy.09.2	2-Wire Analog Input Module: CH1 Rate Alarm Lower limit
Input	XGF-AW4SCH1_RAH	BIT	Uxy.09.3	2-Wire Analog Input Module: CH1 Rate Alarm High limit
Input	XGF-AW4SCH2_RAL	BIT	Uxy.09.4	2-Wire Analog Input Module: CH2 Rate Alarm Lower limit
Input	XGF-AW4SCH2_RAH	BIT	Uxy.09.5	2-Wire Analog Input Module: CH2 Rate Alarm High limit
Input	XGF-AW4SCH3_RAL	BIT	Uxy.09.6	2-Wire Analog Input Module: CH3 Rate Alarm Lower limit
Input	XGF-AW4SCH3_RAH	BIT	Uxy.09.7	2-Wire Analog Input Module: CH3 Rate Alarm High limit

Input	XGF-AW4SCH0_IDD	BIT	Uxy.10.0	2-Wire Analog Input Module: CH0 input disconnection detection
Input	XGF-AW4SCH1_IDD	BIT	Uxy.10.1	2-Wire Analog Input Module: CH1 input disconnection detection
Input	XGF-AW4SCH2_IDD	BIT	Uxy.10.2	2-Wire Analog Input Module: CH2 input disconnection detection
Input	XGF-AW4SCH3_IDD	BIT	Uxy.10.3	2-Wire Analog Input Module: CH3 input disconnection detection
Output	XGF-AW4SERR_CLR	BIT	Uxy.11.0	2-Wire Analog Input Module: Error clear request

2) Refresh data

<Input>

Input/output	Variable	type	Word(16BIT) Offset	Comment
Input	XGF-AW4SERR	BIT	0.0	2-Wire Analog Input Module: Module error
Input	XGF-AW4SRDY	BIT	0.F	2-Wire Analog Input Module: Module ready
Input	XGF-AW4SCH0_ACT	BIT	1.0	2-Wire Analog Input Module: CH0 RUN
Input	XGF-AW4SCH1_ACT	BIT	1.1	2-Wire Analog Input Module: CH1 RUN
Input	XGF-AW4SCH2_ACT	BIT	1.2	2-Wire Analog Input Module: CH2 RUN
Input	XGF-AW4SCH3_ACT	BIT	1.3	2-Wire Analog Input Module: CH3 RUN
Input	XGF-AW4SCH0_DATA	WORD	2	2-Wire Analog Input Module: CH0 conversion value
Input	XGF-AW4SCH1_DATA	WORD	3	2-Wire Analog Input Module: CH1 conversion value
Input	XGF-AW4SCH2_DATA	WORD	4	2-Wire Analog Input Module: CH2 conversion value
Input	XGF-AW4SCH3_DATA	WORD	5	2-Wire Analog Input Module: CH3 conversion value
Input		WORD	6	Reserved
Input		WORD	7	Reserved
Input	XGF-AW4SCH0_PALL	BIT	8.0	2-Wire Analog Input Module: CH0 process alarm LL
Input	XGF-AW4SCH0_PAL	BIT	8.1	2-Wire Analog Input Module: CH0 process alarm lower limit
Input	XGF-AW4SCH0_PAH	BIT	8.2	2-Wire Analog Input Module: CH0 process alarm H
Input	XGF-AW4SCH0_PAHH	BIT	8.3	2-Wire Analog Input Module: CH0 process alarm HH
Input	XGF-AW4SCH1_PALL	BIT	8.4	2-Wire Analog Input Module: CH1 process alarm LL
Input	XGF-AW4SCH1_PAL	BIT	8.5	2-Wire Analog Input Module: CH1 process alarm lower limit
Input	XGF-AW4SCH1_PAH	BIT	8.6	2-Wire Analog Input Module: CH1 process alarm H
Input	XGF-AW4SCH1_PAHH	BIT	8.7	2-Wire Analog Input Module: CH1 process alarm HH
Input	XGF-AW4SCH2_PALL	BIT	8.8	2-Wire Analog Input Module: CH2 process alarm LL
Input	XGF-AW4SCH2_PAL	BIT	8.9	2-Wire Analog Input Module: CH2 process alarm lower limit
Input	XGF-AW4SCH2_PAH	BIT	8.A	2-Wire Analog Input Module: CH2 process alarm H
Input	XGF-AW4SCH2_PAHH	BIT	8.B	2-Wire Analog Input Module: CH2 process alarm HH
Input	XGF-AW4SCH3_PALL	BIT	8.C	2-Wire Analog Input Module: CH3 process alarm LL
Input	XGF-AW4SCH3_PAL	BIT	8.D	2-Wire Analog Input Module: CH3 process alarm lower limit
Input	XGF-AW4SCH3_PAH	BIT	8.E	2-Wire Analog Input Module: CH3 process alarm H
Input	XGF-AW4SCH3_PAHH	BIT	8.F	2-Wire Analog Input Module: CH3 process alarm HH
Input	XGF-AW4SCH0_RAL	BIT	9.0	2-Wire Analog Input Module: CH0 Rate Alarm Lower limit
Input	XGF-AW4SCH0_RAH	BIT	9.1	2-Wire Analog Input Module: CH0 Rate Alarm High limit
Input	XGF-AW4SCH1_RAL	BIT	9.2	2-Wire Analog Input Module: CH1 Rate Alarm Lower limit
Input	XGF-AW4SCH1_RAH	BIT	9.3	2-Wire Analog Input Module: CH1 Rate Alarm High limit
Input	XGF-AW4SCH2_RAL	BIT	9.4	2-Wire Analog Input Module: CH2 Rate Alarm Lower limit
Input	XGF-AW4SCH2_RAH	BIT	9.5	2-Wire Analog Input Module: CH2 Rate Alarm High limit
Input	XGF-AW4SCH3_RAL	BIT	9.6	2-Wire Analog Input Module: CH3 Rate Alarm Lower limit
Input	XGF-AW4SCH3_RAH	BIT	9.7	2-Wire Analog Input Module: CH3 Rate Alarm High limit
Input	XGF-AW4SCH0_IDD	BIT	10.0	2-Wire Analog Input Module: CH0 input disconnection detection
Input	XGF-AW4SCH1_IDD	BIT	10.1	2-Wire Analog Input Module: CH1 input disconnection detection

Appendix

Input	XGF-AW4SCH2_IDD	BIT	10.2	2-Wire Analog Input Module: CH2 input disconnection detection
Input	XGF-AW4SCH3_IDD	BIT	10.3	2-Wire Analog Input Module: CH3 input disconnection detection

<Output>

Input/Output	Variable	type	Word(16BIT) Offset	Comment
Output	XGF-AW4SERR_CLR	BIT	0.0	2-Wire Analog Input Module: Error clear request

(7) XGF-DV4A

1) U Device

Input/output	Variable	type	Device	Comment
Input	XGF-DV4A_CH0_ERR	BIT	Uxy.00.0	Analog Output module: Channel 0 error
Input	XGF-DV4A_CH1_ERR	BIT	Uxy.00.1	Analog Output module: Channel 1 error
Input	XGF-DV4A_CH2_ERR	BIT	Uxy.00.2	Analog Output module: Channel 2 error
Input	XGF-DV4A_CH3_ERR	BIT	Uxy.00.3	Analog Output module: Channel 3 error
Input	XGF-DV4A_RDY	BIT	Uxy.00.F	Analog Output module: Module ready
Input	XGF-DV4A_CH0_ACT	BIT	Uxy.01.0	Analog Output module: CH0 RUN
Input	XGF-DV4A_CH1_ACT	BIT	Uxy.01.1	Analog Output module: CH1 RUN
Input	XGF-DV4A_CH2_ACT	BIT	Uxy.01.2	Analog Output module: CH2 RUN
Input	XGF-DV4A_CH3_ACT	BIT	Uxy.01.3	Analog Output module: CH3 RUN
Output	XGF-DV4A_CH0_OUTEN	BIT	Uxy.02.0	Analog Output module: Channel 0 output status setting
Output	XGF-DV4A_CH1_OUTEN	BIT	Uxy.02.1	Analog Output module: Channel 1 output status setting
Output	XGF-DV4A_CH2_OUTEN	BIT	Uxy.02.2	Analog Output module: Channel 2 output status setting
Output	XGF-DV4A_CH3_OUTEN	BIT	Uxy.02.3	Analog Output module: Channel 3 output status setting
Output	XGF-DV4A_CH0_DATA	WORD	Uxy.03	Analog Output module: Channel 0 Input value
Output	XGF-DV4A_CH1_DATA	WORD	Uxy.04	Analog Output module: Channel 1 Input value
Output	XGF-DV4A_CH2_DATA	WORD	Uxy.05	Analog Output module: Channel 2 Input value
Output	XGF-DV4A_CH3_DATA	WORD	Uxy.06	Analog Output module: Channel 3 Input value

2) Refresh data

<Input>

Input/output	Variable	type	Word(16BIT) Offset	Comment
Input	XGF-DV4A_CH0_ERR	BIT	0.0	Analog Output module: Channel 0 error
Input	XGF-DV4A_CH1_ERR	BIT	0.1	Analog Output module: Channel 1 error
Input	XGF-DV4A_CH2_ERR	BIT	0.2	Analog Output module: Channel 2 error
Input	XGF-DV4A_CH3_ERR	BIT	0.3	Analog Output module: Channel 3 error
Input	XGF-DV4A_RDY	BIT	0.F	Analog Output module: Module ready
Input	XGF-DV4A_CH0_ACT	BIT	1.0	Analog Output module: CH0 RUN
Input	XGF-DV4A_CH1_ACT	BIT	1.1	Analog Output module: CH1 RUN
Input	XGF-DV4A_CH2_ACT	BIT	1.2	Analog Output module: CH2 RUN
Input	XGF-DV4A_CH3_ACT	BIT	1.3	Analog Output module: CH3 RUN

<Output>

Input/output	Variable	type	Word(16BIT) Offset	Comment
Output	XGF-DV4A_CH0_OUTEN	BIT	0.0	Analog Output module: Channel 0 output status setting
Output	XGF-DV4A_CH1_OUTEN	BIT	0.1	Analog Output module: Channel 1 output status setting

Output	XGF-DV4A_CH2_OUTEN	BIT	0.2	Analog Output module: Channel 2 output status setting
Output	XGF-DV4A_CH3_OUTEN	BIT	0.3	Analog Output module: Channel 3 output status setting
Output	XGF-DV4A_CH0_DATA	WORD	1	Analog Output module: Channel 0 Input value
Output	XGF-DV4A_CH1_DATA	WORD	2	Analog Output module: Channel 1 Input value
Output	XGF-DV4A_CH2_DATA	WORD	3	Analog Output module: Channel 2 Input value
Output	XGF-DV4A_CH3_DATA	WORD	4	Analog Output module: Channel 3 Input value
Output		WORD	5	Reserved
Output		WORD	6	Reserved
Output		WORD	7	Reserved
Output		WORD	8	Reserved
Output		Word	9	Reserved

(8) XGF-DC4A

1) U Device

Input/output	Variable	type	Device	Comment
Input	XGF-DC4A_CH0_ERR	BIT	Uxy.00.0	Analog Output module: Channel 0 error
Input	XGF-DC4A_CH1_ERR	BIT	Uxy.00.1	Analog Output module: Channel 1 error
Input	XGF-DC4A_CH2_ERR	BIT	Uxy.00.2	Analog Output module: Channel 2 error
Input	XGF-DC4A_CH3_ERR	BIT	Uxy.00.3	Analog Output module: Channel 3 error
Input	XGF-DC4A_RDY	BIT	Uxy.00.F	Analog Output module: Module ready
Input	XGF-DC4A_CH0_ACT	BIT	Uxy.01.0	Analog Output module: CH0 RUN
Input	XGF-DC4A_CH1_ACT	BIT	Uxy.01.1	Analog Output module: CH1 RUN
Input	XGF-DC4A_CH2_ACT	BIT	Uxy.01.2	Analog Output module: CH2 RUN
Input	XGF-DC4A_CH3_ACT	BIT	Uxy.01.3	Analog Output module: CH3 RUN
Output	XGF-DC4A_CH0_OUTEN	BIT	Uxy.02.0	Analog Output module: Channel 0 output status setting
Output	XGF-DC4A_CH1_OUTEN	BIT	Uxy.02.1	Analog Output module: Channel 1 output status setting
Output	XGF-DC4A_CH2_OUTEN	BIT	Uxy.02.2	Analog Output module: Channel 2 output status setting
Output	XGF-DC4A_CH3_OUTEN	BIT	Uxy.02.3	Analog Output module: Channel 3 output status setting
Output	XGF-DC4A_CH0_DATA	WORD	Uxy.03	Analog Output module: Channel 0 Input value
Output	XGF-DC4A_CH1_DATA	WORD	Uxy.04	Analog Output module: Channel 1 Input value
Output	XGF-DC4A_CH2_DATA	WORD	Uxy.05	Analog Output module: Channel 2 Input value
Output	XGF-DC4A_CH3_DATA	WORD	Uxy.06	Analog Output module: Channel 3 Input value

2) Refresh data

<Input>

Input/output	Variable	type	Word(16BIT) Offset	Comment
Input	XGF-DC4A_CH0_ERR	BIT	0.0	Analog Output module: Channel 0 error
Input	XGF-DC4A_CH1_ERR	BIT	0.1	Analog Output module: Channel 1 error
Input	XGF-DC4A_CH2_ERR	BIT	0.2	Analog Output module: Channel 2 error
Input	XGF-DC4A_CH3_ERR	BIT	0.3	Analog Output module: Channel 3 error
Input	XGF-DC4A_RDY	BIT	0.F	Analog Output module: Module ready
Input	XGF-DC4A_CH0_ACT	BIT	1.0	Analog Output module: CH0 RUN
Input	XGF-DC4A_CH1_ACT	BIT	1.1	Analog Output module: CH1 RUN

Appendix

Input	XGF-DC4A_CH2_ACT	BIT	1.2	Analog Output module: CH2 RUN
Input	XGF-DC4A_CH3_ACT	BIT	1.3	Analog Output module: CH3 RUN

<Output>

Input/output	Variable	type	Word(16BIT) Offset	Comment
Output	XGF-DC4A_CH0_OUTEN	BIT	0.0	Analog Output module: Channel 0 output status setting
Output	XGF-DC4A_CH1_OUTEN	BIT	0.1	Analog Output module: Channel 1 output status setting
Output	XGF-DC4A_CH2_OUTEN	BIT	0.2	Analog Output module: Channel 2 output status setting
Output	XGF-DC4A_CH3_OUTEN	BIT	0.3	Analog Output module: Channel 3 output status setting
Output	XGF-DC4A_CH0_DATA	Word	1	Analog Output module: Channel 0 Input value
Output	XGF-DC4A_CH1_DATA	WORD	2	Analog Output module: Channel 1 Input value
Output	XGF-DC4A_CH2_DATA	WORD	3	Analog Output module: Channel 2 Input value
Output	XGF-DC4A_CH3_DATA	WORD	4	Analog Output module: Channel 3 Input value
Output		WORD	5	Reserved
Output		WORD	6	Reserved
Output		WORD	7	Reserved
Output		WORD	8	Reserved
Output		WORD	9	Reserved

(9) XGF-DV8A

1) U Device

Input/output	Variable	type	Device	Comment
Input	XGF-DV8A_CH0_ERR	BIT	Uxy.00.0	Analog Output module: Channel 0 error
Input	XGF-DV8A_CH1_ERR	BIT	Uxy.00.1	Analog Output module: Channel 1 error
Input	XGF-DV8A_CH2_ERR	BIT	Uxy.00.2	Analog Output module: Channel 2 error
Input	XGF-DV8A_CH3_ERR	BIT	Uxy.00.3	Analog Output module: Channel 3 error
Input	XGF-DV8A_CH4_ERR	BIT	Uxy.00.4	Analog Output module: Channel 4 error
Input	XGF-DV8A_CH5_ERR	BIT	Uxy.00.5	Analog Output module: Channel 5 error
Input	XGF-DV8A_CH6_ERR	BIT	Uxy.00.6	Analog Output module: Channel 6 error
Input	XGF-DV8A_CH7_ERR	BIT	Uxy.00.7	Analog Output module: Channel 7 error
Input	XGF-DV8A_RDY	BIT	Uxy.00.F	Analog Output module: Module ready
Input	XGF-DV8A_CH0_ACT	BIT	Uxy.01.0	Analog Output module: CH0 RUN
Input	XGF-DV8A_CH1_ACT	BIT	Uxy.01.1	Analog Output module: CH1 RUN
Input	XGF-DV8A_CH2_ACT	BIT	Uxy.01.2	Analog Output module: CH2 RUN
Input	XGF-DV8A_CH3_ACT	BIT	Uxy.01.3	Analog Output module: CH3 RUN
Input	XGF-DV8A_CH4_ACT	BIT	Uxy.01.4	Analog Output module: CH4 RUN
Input	XGF-DV8A_CH5_ACT	BIT	Uxy.01.5	Analog Output module: CH5 RUN
Input	XGF-DV8A_CH6_ACT	BIT	Uxy.01.6	Analog Output module: CH6 RUN
Input	XGF-DV8A_CH7_ACT	BIT	Uxy.01.7	Analog Output module: CH7 RUN
Output	XGF-DV8A_CH0_OUTEN	BIT	Uxy.02.0	Analog Output module: Channel 0 output status setting
Output	XGF-DV8A_CH1_OUTEN	BIT	Uxy.02.1	Analog Output module: Channel 1 output status setting
Output	XGF-DV8A_CH2_OUTEN	BIT	Uxy.02.2	Analog Output module: Channel 2 output status setting
Output	XGF-DV8A_CH3_OUTEN	BIT	Uxy.02.3	Analog Output module: Channel 3 output status setting

Output	XGF-DV8A_CH4_OUTEN	BIT	Uxy.02.4	Analog Output module: Channel 4 output status setting
Output	XGF-DV8A_CH5_OUTEN	BIT	Uxy.02.5	Analog Output module: Channel 5 output status setting
Output	XGF-DV8A_CH6_OUTEN	BIT	Uxy.02.6	Analog Output module: Channel 6 output status setting
Output	XGF-DV8A_CH7_OUTEN	BIT	Uxy.02.7	Analog Output module: Channel 7 output status setting
Output	XGF-DV8A_CH0_DATA	Word	Uxy.03	Analog Output module: Channel 0 Input value
Output	XGF-DV8A_CH1_DATA	WORD	Uxy.04	Analog Output module: Channel 1 Input value
Output	XGF-DV8A_CH2_DATA	WORD	Uxy.05	Analog Output module: Channel 2 Input value
Output	XGF-DV8A_CH3_DATA	WORD	Uxy.06	Analog Output module: Channel 3 Input value
Output	XGF-DV8A_CH4_DATA	WORD	Uxy.07	Analog Output module: Channel 4 Input value
Output	XGF-DV8A_CH5_DATA	WORD	Uxy.08	Analog Output module: Channel 5 Input value
Output	XGF-DV8A_CH6_DATA	Word	Uxy.09	Analog Output module: Channel 6 Input value
Output	XGF-DV8A_CH7_DATA	WORD	Uxy.10	Analog Output module: Channel 7 Input value

2) Refresh data

<Input>

Input/output	Variable	type	Word(16BIT) Offset	Comment
Input	XGF-DV8A_CH0_ERR	BIT	0.0	Analog Output module: Channel 0 error
Input	XGF-DV8A_CH1_ERR	BIT	0.1	Analog Output module: Channel 1 error
Input	XGF-DV8A_CH2_ERR	BIT	0.2	Analog Output module: Channel 2 error
Input	XGF-DV8A_CH3_ERR	BIT	0.3	Analog Output module: Channel 3 error
Input	XGF-DV8A_CH4_ERR	BIT	0.4	Analog Output module: Channel 4 error
Input	XGF-DV8A_CH5_ERR	BIT	0.5	Analog Output module: Channel 5 error
Input	XGF-DV8A_CH6_ERR	BIT	0.6	Analog Output module: Channel 6 error
Input	XGF-DV8A_CH7_ERR	BIT	0.7	Analog Output module: Channel 7 error
Input	XGF-DV8A_RDY	BIT	0.F	Analog Output module: Module ready
Input	XGF-DV8A_CH0_ACT	BIT	1.0	Analog Output module: CH0 RUN
Input	XGF-DV8A_CH1_ACT	BIT	1.1	Analog Output module: CH1 RUN
Input	XGF-DV8A_CH2_ACT	BIT	1.2	Analog Output module: CH2 RUN
Input	XGF-DV8A_CH3_ACT	BIT	1.3	Analog Output module: CH3 RUN
Input	XGF-DV8A_CH4_ACT	BIT	1.4	Analog Output module: CH4 RUN
Input	XGF-DV8A_CH5_ACT	BIT	1.5	Analog Output module: CH5 RUN
Input	XGF-DV8A_CH6_ACT	BIT	1.6	Analog Output module: CH6 RUN
Input	XGF-DV8A_CH7_ACT	BIT	1.7	Analog Output module: CH7 RUN

<Output>

Input/Output	Variable	type	Word(16BIT) Offset	Comment
Output	XGF-DV8A_CH0_OUTEN	BIT	0.0	Analog Output module: Channel 0 output status setting
Output	XGF-DV8A_CH1_OUTEN	BIT	0.1	Analog Output module: Channel 1 output status setting
Output	XGF-DV8A_CH2_OUTEN	BIT	0.2	Analog Output module: Channel 2 output status setting
Output	XGF-DV8A_CH3_OUTEN	BIT	0.3	Analog Output module: Channel 3 output status setting

Appendix

Output	XGF-DV8A_CH4_OUTEN	BIT	0.4	Analog Output module: Channel 4 output status setting
Output	XGF-DV8A_CH5_OUTEN	BIT	0.5	Analog Output module: Channel 5 output status setting
Output	XGF-DV8A_CH6_OUTEN	BIT	0.6	Analog Output module: Channel 6 output status setting
Output	XGF-DV8A_CH7_OUTEN	BIT	0.7	Analog Output module: Channel 7 output status setting
Output	XGF-DV8A_CH0_DATA	WORD	1	Analog Output module: Channel 0 Input value
Output	XGF-DV8A_CH1_DATA	WORD	2	Analog Output module: Channel 1 Input value
Output	XGF-DV8A_CH2_DATA	WORD	3	Analog Output module: Channel 2 Input value
Output	XGF-DV8A_CH3_DATA	WORD	4	Analog Output module: Channel 3 Input value
Output	XGF-DV8A_CH4_DATA	WORD	5	Analog Output module: Channel 4 Input value
Output	XGF-DV8A_CH5_DATA	WORD	6	Analog Output module: Channel 5 Input value
Output	XGF-DV8A_CH6_DATA	WORD	7	Analog Output module: Channel 6 Input value
Output	XGF-DV8A_CH7_DATA	WORD	8	Analog Output module: Channel 7 Input value
Output		WORD	9	Reserved

(10) XGF-DC8A

1) U Device

Input/Output	Variable	type	Device	Comment
Input	XGF-DC8A_CH0_ERR	BIT	Uxy.00.0	Analog Output module: Channel 0 error
Input	XGF-DC8A_CH1_ERR	BIT	Uxy.00.1	Analog Output module: Channel 1 error
Input	XGF-DC8A_CH2_ERR	BIT	Uxy.00.2	Analog Output module: Channel 2 error
Input	XGF-DC8A_CH3_ERR	BIT	Uxy.00.3	Analog Output module: Channel 3 error
Input	XGF-DC8A_CH4_ERR	BIT	Uxy.00.4	Analog Output module: Channel 4 error
Input	XGF-DC8A_CH5_ERR	BIT	Uxy.00.5	Analog Output module: Channel 5 error
Input	XGF-DC8A_CH6_ERR	BIT	Uxy.00.6	Analog Output module: Channel 6 error
Input	XGF-DC8A_CH7_ERR	BIT	Uxy.00.7	Analog Output module: Channel 7 error
Input	XGF-DC8A_RDY	BIT	Uxy.00.F	Analog Output module: Module ready
Input	XGF-DC8A_CH0_ACT	BIT	Uxy.01.0	Analog Output module: CH0 RUN
Input	XGF-DC8A_CH1_ACT	BIT	Uxy.01.1	Analog Output module: CH1 RUN
Input	XGF-DC8A_CH2_ACT	BIT	Uxy.01.2	Analog Output module: CH2 RUN
Input	XGF-DC8A_CH3_ACT	BIT	Uxy.01.3	Analog Output module: CH3 RUN
Input	XGF-DC8A_CH4_ACT	BIT	Uxy.01.4	Analog Output module: CH4 RUN
Input	XGF-DC8A_CH5_ACT	BIT	Uxy.01.5	Analog Output module: CH5 RUN
Input	XGF-DC8A_CH6_ACT	BIT	Uxy.01.6	Analog Output module: CH6 RUN
Input	XGF-DC8A_CH7_ACT	BIT	Uxy.01.7	Analog Output module: CH7 RUN
Output	XGF-DC8A_CH0_OUTEN	BIT	Uxy.02.0	Analog Output module: Channel 0 output status setting
Output	XGF-DC8A_CH1_OUTEN	BIT	Uxy.02.1	Analog Output module: Channel 1 output status setting
Output	XGF-DC8A_CH2_OUTEN	BIT	Uxy.02.2	Analog Output module: Channel 2 output status setting
Output	XGF-DC8A_CH3_OUTEN	BIT	Uxy.02.3	Analog Output module: Channel 3 output status setting
Output	XGF-DC8A_CH4_OUTEN	BIT	Uxy.02.4	Analog Output module: Channel 4 output status setting
Output	XGF-DC8A_CH5_OUTEN	BIT	Uxy.02.5	Analog Output module: Channel 5 output status setting

Output	XGF-DC8A_CH6_OUTEN	BIT	Uxy.02.6	Analog Output module: Channel 6 output status setting
Output	XGF-DC8A_CH7_OUTEN	BIT	Uxy.02.7	Analog Output module: Channel 7 output status setting
Output	XGF-DC8A_CH0_DATA	WORD	Uxy.03	Analog Output module: Channel 0 Input value
Output	XGF-DC8A_CH1_DATA	WORD	Uxy.04	Analog Output module: Channel 1 Input value
Output	XGF-DC8A_CH2_DATA	WORD	Uxy.05	Analog Output module: Channel 2 Input value
Output	XGF-DC8A_CH3_DATA	WORD	Uxy.06	Analog Output module: Channel 3 Input value
Output	XGF-DC8A_CH4_DATA	WORD	Uxy.07	Analog Output module: Channel 4 Input value
Output	XGF-DC8A_CH5_DATA	WORD	Uxy.08	Analog Output module: Channel 5 Input value
Output	XGF-DC8A_CH6_DATA	WORD	Uxy.09	Analog Output module: Channel 6 Input value
Output	XGF-DC8A_CH7_DATA	WORD	Uxy.10	Analog Output module: Channel 7 Input value

2) Refresh data

<Input>

Input/Output	Variable	type	Word(16BIT) Offset	Comment
Input	XGF-DC8A_CH0_ERR	BIT	0.0	Analog Output module: Channel 0 error
Input	XGF-DC8A_CH1_ERR	BIT	0.1	Analog Output module: Channel 1 error
Input	XGF-DC8A_CH2_ERR	BIT	0.2	Analog Output module: Channel 2 error
Input	XGF-DC8A_CH3_ERR	BIT	0.3	Analog Output module: Channel 3 error
Input	XGF-DC8A_CH4_ERR	BIT	0.4	Analog Output module: Channel 4 error
Input	XGF-DC8A_CH5_ERR	BIT	0.5	Analog Output module: Channel 5 error
Input	XGF-DC8A_CH6_ERR	BIT	0.6	Analog Output module: Channel 6 error
Input	XGF-DC8A_CH7_ERR	BIT	0.7	Analog Output module: Channel 7 error
Input	XGF-DC8A_RDY	BIT	0.F	Analog Output module: Module ready
Input	XGF-DC8A_CH0_ACT	BIT	1.0	Analog Output module: CH0 RUN
Input	XGF-DC8A_CH1_ACT	BIT	1.1	Analog Output module: CH1 RUN
Input	XGF-DC8A_CH2_ACT	BIT	1.2	Analog Output module: CH2 RUN
Input	XGF-DC8A_CH3_ACT	BIT	1.3	Analog Output module: CH3 RUN
Input	XGF-DC8A_CH4_ACT	BIT	1.4	Analog Output module: CH4 RUN
Input	XGF-DC8A_CH5_ACT	BIT	1.5	Analog Output module: CH5 RUN
Input	XGF-DC8A_CH6_ACT	BIT	1.6	Analog Output module: CH6 RUN
Input	XGF-DC8A_CH7_ACT	BIT	1.7	Analog Output module: CH7 RUN

<Output>

Input/Output	Variable	type	Word(16BIT) Offset	Comment
Output	XGF-DC8A_CH0_OUTEN	BIT	0.0	Analog Output module: Channel 0 output status setting
Output	XGF-DC8A_CH1_OUTEN	BIT	0.1	Analog Output module: Channel 1 output status setting
Output	XGF-DC8A_CH2_OUTEN	BIT	0.2	Analog Output module: Channel 2 output status setting

Appendix

Output	XGF-DC8A_CH3_OUTEN	BIT	0.3	Analog Output module: Channel 3 output status setting
Output	XGF-DC8A_CH4_OUTEN	BIT	0.4	Analog Output module: Channel 4 output status setting
Output	XGF-DC8A_CH5_OUTEN	BIT	0.5	Analog Output module: Channel 5 output status setting
Output	XGF-DC8A_CH6_OUTEN	BIT	0.6	Analog Output module: Channel 6 output status setting
Output	XGF-DC8A_CH7_OUTEN	BIT	0.7	Analog Output module: Channel 7 output status setting
Output	XGF-DC8A_CH0_DATA	WORD	1	Analog Output module: Channel 0 Input value
Output	XGF-DC8A_CH1_DATA	WORD	2	Analog Output module: Channel 1 Input value
Output	XGF-DC8A_CH2_DATA	WORD	3	Analog Output module: Channel 2 Input value
Output	XGF-DC8A_CH3_DATA	WORD	4	Analog Output module: Channel 3 Input value
Output	XGF-DC8A_CH4_DATA	WORD	5	Analog Output module: Channel 4 Input value
Output	XGF-DC8A_CH5_DATA	WORD	6	Analog Output module: Channel 5 Input value
Output	XGF-DC8A_CH6_DATA	WORD	7	Analog Output module: Channel 6 Input value
Output	XGF-DC8A_CH7_DATA	WORD	8	Analog Output module: Channel 7 Input value
Output		WORD	9	Reserved

(11) XGF-DV4S

1) U Device

Input/Output	Variable	type	Device	Comment
Input	XGF-DV4S_CH0_ERR	BIT	Uxy.00.0	Isolated Analog Output module: Channel 0 error
Input	XGF-DV4S_CH1_ERR	BIT	Uxy.00.1	Isolated Analog Output module: Channel 1 error
Input	XGF-DV4S_CH2_ERR	BIT	Uxy.00.2	Isolated Analog Output module: Channel 2 error
Input	XGF-DV4S_CH3_ERR	BIT	Uxy.00.3	Isolated Analog Output module: Channel 3 error
Input	XGF-DV4S_RDY	BIT	Uxy.00.F	Isolated Analog Output module: Module ready
Input	XGF-DV4S_CH0_ACT	BIT	Uxy.01.0	Isolated Analog Output module: CH0 RUN
Input	XGF-DV4S_CH1_ACT	BIT	Uxy.01.1	Isolated Analog Output module: CH1 RUN
Input	XGF-DV4S_CH2_ACT	BIT	Uxy.01.2	Isolated Analog Output module: CH2 RUN
Input	XGF-DV4S_CH3_ACT	BIT	Uxy.01.3	Isolated Analog Output module: CH3 RUN
Output	XGF-DV4S_CH0_OUTEN	BIT	Uxy.02.0	Isolated Analog Output module: Channel 0 output status setting
Output	XGF-DV4S_CH1_OUTEN	BIT	Uxy.02.1	Isolated Analog Output module: Channel 1 output status setting
Output	XGF-DV4S_CH2_OUTEN	BIT	Uxy.02.2	Isolated Analog Output module: Channel 2 output status setting
Output	XGF-DV4S_CH3_OUTEN	BIT	Uxy.02.3	Isolated Analog Output module: Channel 3 output status setting
Output	XGF-DV4S_CH0_DATA	WORD	Uxy.03	Isolated Analog Output module: Channel 0 Input value
Output	XGF-DV4S_CH1_DATA	WORD	Uxy.04	Isolated Analog Output module: Channel 1 Input value
Output	XGF-DV4S_CH2_DATA	WORD	Uxy.05	Isolated Analog Output module: Channel 2 Input value
Output	XGF-DV4S_CH3_DATA	WORD	Uxy.06	Isolated Analog Output module: Channel 3 Input value

2) Refresh data

<Input>

Input/Output	Variable	type	Word(16BIT) Offset	Comment
Input	XGF-DV4S_CH0_ERR	BIT	0.0	Isolated Analog Output module: Channel 0 error
Input	XGF-DV4S_CH1_ERR	BIT	0.1	Isolated Analog Output module: Channel 1 error

Input	XGF-DV4S_CH2_ERR	BIT	0.2	Isolated Analog Output module: Channel 2 error
Input	XGF-DV4S_CH3_ERR	BIT	0.3	Isolated Analog Output module: Channel 3 error
Input	XGF-DV4S_RDY	BIT	0.F	Isolated Analog Output module: Module ready
Input	XGF-DV4S_CH0_ACT	BIT	1.0	Isolated Analog Output module: CH0 RUN
Input	XGF-DV4S_CH1_ACT	BIT	1.1	Isolated Analog Output module: CH1 RUN
Input	XGF-DV4S_CH2_ACT	BIT	1.2	Isolated Analog Output module: CH2 RUN
Input	XGF-DV4S_CH3_ACT	BIT	1.3	Isolated Analog Output module: CH3 RUN

<Output>

Input/Output	Variable	type	Word(16BIT) Offset	Comment
Output	XGF-DV4S_CH0_OUTEN	BIT	0.0	Isolated Analog Output module: Channel 0 output status setting
Output	XGF-DV4S_CH1_OUTEN	BIT	0.1	Isolated Analog Output module: Channel 1 output status setting
Output	XGF-DV4S_CH2_OUTEN	BIT	0.2	Isolated Analog Output module: Channel 2 output status setting
Output	XGF-DV4S_CH3_OUTEN	BIT	0.3	Isolated Analog Output module: Channel 3 output status setting
Output	XGF-DV4S_CH0_DATA	WORD	1	Isolated Analog Output module: Channel 0 Input value
Output	XGF-DV4S_CH1_DATA	WORD	2	Isolated Analog Output module: Channel 1 Input value
Output	XGF-DV4S_CH2_DATA	WORD	3	Isolated Analog Output module: Channel 2 Input value
Output	XGF-DV4S_CH3_DATA	WORD	4	Isolated Analog Output module: Channel 3 Input value
Output		WORD	5	Reserved
Output		WORD	6	Reserved
Output		WORD	7	Reserved
Output		WORD	8	Reserved
Output		WORD	9	Reserved

(12) XGF-DC4S

1) U Device

Input/Output	Variable	type	Device	Comment
Input	XGF-DC4S_CH0_ERR	BIT	Uxy.00.0	Isolated Analog Output module: Channel 0 error
Input	XGF-DC4S_CH1_ERR	BIT	Uxy.00.1	Isolated Analog Output module: Channel 1 error
Input	XGF-DC4S_CH2_ERR	BIT	Uxy.00.2	Isolated Analog Output module: Channel 2 error
Input	XGF-DC4S_CH3_ERR	BIT	Uxy.00.3	Isolated Analog Output module: Channel 3 error
Input	XGF-DC4S_RDY	BIT	Uxy.00.F	Isolated Analog Output module: Module ready
Input	XGF-DC4S_CH0_ACT	BIT	Uxy.01.0	Isolated Analog Output module: CH0 RUN
Input	XGF-DC4S_CH1_ACT	BIT	Uxy.01.1	Isolated Analog Output module: CH1 RUN
Input	XGF-DC4S_CH2_ACT	BIT	Uxy.01.2	Isolated Analog Output module: CH2 RUN
Input	XGF-DC4S_CH3_ACT	BIT	Uxy.01.3	Isolated Analog Output module: CH3 RUN
Output	XGF-DC4S_CH0_OUTEN	BIT	Uxy.02.0	Isolated Analog Output module: Channel 0 output status setting
Output	XGF-DC4S_CH1_OUTEN	BIT	Uxy.02.1	Isolated Analog Output module: Channel 1 output status setting
Output	XGF-DC4S_CH2_OUTEN	BIT	Uxy.02.2	Isolated Analog Output module: Channel 2 output status setting
Output	XGF-DC4S_CH3_OUTEN	BIT	Uxy.02.3	Isolated Analog Output module: Channel 3 output status setting

Appendix

Output	XGF-DC4S_CH0_DATA	WORD	Uxy.03	Isolated Analog Output module: Channel 0 Input value
Output	XGF-DC4S_CH1_DATA	WORD	Uxy.04	Isolated Analog Output module: Channel 1 Input value
Output	XGF-DC4S_CH2_DATA	WORD	Uxy.05	Isolated Analog Output module: Channel 2 Input value
Output	XGF-DC4S_CH3_DATA	WORD	Uxy.06	Isolated Analog Output module: Channel 3 Input value

2) Refresh data

<Input>

Input/Output	Variable	type	Word(16BIT) Offset	Comment
Input	XGF-DC4S_CH0_ERR	BIT	0.0	Isolated Analog Output module: Channel 0 error
Input	XGF-DC4S_CH1_ERR	BIT	0.1	Isolated Analog Output module: Channel 1 error
Input	XGF-DC4S_CH2_ERR	BIT	0.2	Isolated Analog Output module: Channel 2 error
Input	XGF-DC4S_CH3_ERR	BIT	0.3	Isolated Analog Output module: Channel 3 error
Input	XGF-DC4S_RDY	BIT	0.F	Isolated Analog Output module: Module ready
Input	XGF-DC4S_CH0_ACT	BIT	1.0	Isolated Analog Output module: CH0 RUN
Input	XGF-DC4S_CH1_ACT	BIT	1.1	Isolated Analog Output module: CH1 RUN
Input	XGF-DC4S_CH2_ACT	BIT	1.2	Isolated Analog Output module: CH2 RUN
Input	XGF-DC4S_CH3_ACT	BIT	1.3	Isolated Analog Output module: CH3 RUN

<Output>

Input/Output	Variable	type	Word(16BIT) Offset	Comment
Output	XGF-DC4S_CH0_OUTEN	BIT	0.0	Isolated Analog Output module: Channel 0 output status setting
Output	XGF-DC4S_CH1_OUTEN	BIT	0.1	Isolated Analog Output module: Channel 1 output status setting
Output	XGF-DC4S_CH2_OUTEN	BIT	0.2	Isolated Analog Output module: Channel 2 output status setting
Output	XGF-DC4S_CH3_OUTEN	BIT	0.3	Isolated Analog Output module: Channel 3 output status setting
Output	XGF-DC4S_CH0_DATA	WORD	1	Isolated Analog Output module: Channel 0 Input value
Output	XGF-DC4S_CH1_DATA	WORD	2	Isolated Analog Output module: Channel 1 Input value
Output	XGF-DC4S_CH2_DATA	WORD	3	Isolated Analog Output module: Channel 2 Input value
Output	XGF-DC4S_CH3_DATA	WORD	4	Isolated Analog Output module: Channel 3 Input value
Output	-	WORD	5	Reserved
Output	-	WORD	6	Reserved
Output	-	WORD	7	Reserved
Output	-	WORD	8	Reserved
Output	-	WORD	9	Reserved

(13) XGF-AH6A

1) U Device

Input/Output	Variable	type	Device	Comment
Input	XGF-AH6A_AD0_ERR	BIT	Uxy.00.0	Analog IO Module: Input Channel 0 error
Input	XGF-AH6A_AD1_ERR	BIT	Uxy.00.1	Analog IO Module: Input Channel 1 error
Input	XGF-AH6A_AD2_ERR	BIT	Uxy.00.2	Analog IO Module: Input Channel 2 error
Input	XGF-AH6A_AD3_ERR	BIT	Uxy.00.3	Analog IO Module: Input Channel 3 error
Input	XGF-AH6A_DA0_ERR	BIT	Uxy.00.4	Analog IO Module: Output Channel 0 error

Input	XGF-AH6A_DA1_ERR	BIT	Uxy.00.5	Analog IO Module: Output Channel 1 error
Input	XGF-AH6A_RDY	BIT	Uxy.00.F	Analog IO Module: Module ready
Input	XGF-AH6A_AD0_ACT	BIT	Uxy.01.0	Analog IO Module: Input Channel 0 Running
Input	XGF-AH6A_AD1_ACT	BIT	Uxy.01.1	Analog IO Module: Input Channel 1 Running
Input	XGF-AH6A_AD2_ACT	BIT	Uxy.01.2	Analog IO Module: Input Channel 2 Running
Input	XGF-AH6A_AD3_ACT	BIT	Uxy.01.3	Analog IO Module: Input Channel 3 Running
Input	XGF-AH6A_DA0_ACT	BIT	Uxy.01.4	Analog IO Module: Output Channel 0 Running
Input	XGF-AH6A_DA1_ACT	BIT	Uxy.01.5	Analog IO Module: Output Channel 1 Running
Input	XGF-AH6A_AD0_IDD	BIT	Uxy.06.0	Analog IO Module: Input Channel 0 Disconnection Flag
Input	XGF-AH6A_AD1_IDD	BIT	Uxy.06.1	Analog IO Module: Input Channel 1 Disconnection Flag
Input	XGF-AH6A_AD2_IDD	BIT	Uxy.06.2	Analog IO Module: Input Channel 2 Disconnection Flag
Input	XGF-AH6A_AD3_IDD	BIT	Uxy.06.3	Analog IO Module: Input Channel 3 Disconnection Flag
Output	XGF-AH6A_ERR_CLR	BIT	Uxy.07.0	Analog IO Module: Error clear request
Output	XGF-AH6A_DA0_OUTEN	BIT	Uxy.08.0	Analog IO Module: Channel 0 output status setting
Output	XGF-AH6A_DA1_OUTEN	BIT	Uxy.08.1	Analog IO Module: Channel 1 output status setting
Input	XGF-AH6A_AD0_DATA	WORD	Uxy.02	Analog IO Module: Input Channel 0 Digital Output Data
Input	XGF-AH6A_AD1_DATA	WORD	Uxy.03	Analog IO Module: Input Channel 1 Digital Output Data
Input	XGF-AH6A_AD2_DATA	WORD	Uxy.04	Analog IO Module: Input Channel 2 Digital Output Data
Input	XGF-AH6A_AD3_DATA	WORD	Uxy.05	Analog IO Module: Input Channel 3 Digital Output Data
Output	XGF-AH6A_DA0_DATA	WORD	Uxy.09	Analog IO Module: Output Channel 0 Digital Input Data
Output	XGF-AH6A_DA1_DATA	Word	Uxy.10	Analog IO Module: Output Channel 1 Digital Input Data

2) Refresh data

<Input>

Input/Output	Variable	type	Word(16BIT) Offset	Comment
Input	XGF-AH6A_AD0_ERR	BIT	0.0	Analog IO Module: Input Channel 0 error
Input	XGF-AH6A_AD1_ERR	BIT	0.1	Analog IO Module: Input Channel 1 error
Input	XGF-AH6A_AD2_ERR	BIT	0.2	Analog IO Module: Input Channel 2 error
Input	XGF-AH6A_AD3_ERR	BIT	0.3	Analog IO Module: Input Channel 3 error
Input	XGF-AH6A_DA0_ERR	BIT	0.4	Analog IO Module: Output Channel 0 error
Input	XGF-AH6A_DA1_ERR	BIT	0.5	Analog IO Module: Output Channel 1 error
Input	XGF-AH6A_RDY	BIT	0.F	Analog IO Module: Module ready
Input	XGF-AH6A_AD0_ACT	BIT	1.0	Analog IO Module: Input Channel 0 Running
Input	XGF-AH6A_AD1_ACT	BIT	1.1	Analog IO Module: Input Channel 1 Running
Input	XGF-AH6A_AD2_ACT	BIT	1.2	Analog IO Module: Input Channel 2 Running
Input	XGF-AH6A_AD3_ACT	BIT	1.3	Analog IO Module: Input Channel 3 Running
Input	XGF-AH6A_DA0_ACT	BIT	1.4	Analog IO Module: Output Channel 0 Running
Input	XGF-AH6A_DA1_ACT	BIT	1.5	Analog IO Module: Output Channel 1 Running
Input	XGF-AH6A_AD0_DATA	WORD	2	Analog IO Module: Input Channel 0 Digital Output Data
Input	XGF-AH6A_AD1_DATA	WORD	3	Analog IO Module: Input Channel 1 Digital Output Data
Input	XGF-AH6A_AD2_DATA	WORD	4	Analog IO Module: Input Channel 2 Digital Output Data
Input	XGF-AH6A_AD3_DATA	WORD	5	Analog IO Module: Input Channel 3 Digital Output Data
Input	XGF-AH6A_AD0_IDD	BIT	6.0	Analog IO Module: Input Channel 0 Disconnection Flag
Input	XGF-AH6A_AD1_IDD	BIT	6.1	Analog IO Module: Input Channel 1 Disconnection Flag
Input	XGF-AH6A_AD2_IDD	BIT	6.2	Analog IO Module: Input Channel 2 Disconnection Flag
Input	XGF-AH6A_AD3_IDD	BIT	6.3	Analog IO Module: Input Channel 3 Disconnection Flag

<Output>

Appendix

Input/Output	Variable	type	Word(16BIT) Offset	Comment
Output	XGF-AH6A_ERR_CLR	BIT	0.0	Analog IO Module: Error clear request
Output	XGF-AH6A_DA0_OUTEN	BIT	1.0	Analog IO Module: Channel 0 output status setting
Output	XGF-AH6A_DA1_OUTEN	BIT	1.1	Analog IO Module: Channel 1 output status setting
Output	XGF-AH6A_DA0_DATA	WORD	2	Analog IO Module: Output Channel 0 Digital Input Data
Output	XGF-AH6A_DA1_DATA	WORD	3	Analog IO Module: Output Channel 1 Digital Input Data
Output		WORD	4	Reserved

(14) XGF-AC4H

1) U Device

Input/Output	Variable	type	Device	Comment
Input	XGF-AC4H_ERR	BIT	Uxy.00.0	HART Analog Input Module: Module error
Input	XGF-AC4H_RDY	BIT	Uxy.00.F	HART Analog Input Module: Module ready
Input	XGF-AC4H_CH0_ACT	BIT	Uxy.01.0	HART Analog Input Module: CH0 RUN
Input	XGF-AC4H_CH1_ACT	BIT	Uxy.01.1	HART Analog Input Module: CH1 RUN
Input	XGF-AC4H_CH2_ACT	BIT	Uxy.01.2	HART Analog Input Module: CH2 RUN
Input	XGF-AC4H_CH3_ACT	BIT	Uxy.01.3	HART Analog Input Module: CH3 RUN
Input	XGF-AC4H_CH0_PAHH	BIT	Uxy.08.0	HART Analog Input Module: CH0 process alarm HH
Input	XGF-AC4H_CH0_PAH	BIT	Uxy.08.1	HART Analog Input Module: CH0 process alarm H
Input	XGF-AC4H_CH0_PAL	BIT	Uxy.08.2	HART Analog Input Module: CH0 process alarm lower limit
Input	XGF-AC4H_CH0_PALL	BIT	Uxy.08.3	HART Analog Input Module: CH0 process alarm LL
Input	XGF-AC4H_CH1_PAHH	BIT	Uxy.08.4	HART Analog Input Module: CH1 process alarm HH
Input	XGF-AC4H_CH1_PAH	BIT	Uxy.08.5	HART Analog Input Module: CH1 process alarm H
Input	XGF-AC4H_CH1_PAL	BIT	Uxy.08.6	HART Analog Input Module: CH1 process alarm lower limit
Input	XGF-AC4H_CH1_PALL	BIT	Uxy.08.7	HART Analog Input Module: CH1 process alarm LL
Input	XGF-AC4H_CH2_PAHH	BIT	Uxy.08.8	HART Analog Input Module: CH2 process alarm HH
Input	XGF-AC4H_CH2_PAH	BIT	Uxy.08.9	HART Analog Input Module: CH2 process alarm H
Input	XGF-AC4H_CH2_PAL	BIT	Uxy.08.A	HART Analog Input Module: CH2 process alarm lower limit
Input	XGF-AC4H_CH2_PALL	BIT	Uxy.08.B	HART Analog Input Module: CH2 process alarm LL
Input	XGF-AC4H_CH3_PAHH	BIT	Uxy.08.C	HART Analog Input Module: CH3 process alarm HH
Input	XGF-AC4H_CH3_PAH	BIT	Uxy.08.D	HART Analog Input Module: CH3 process alarm H
Input	XGF-AC4H_CH3_PAL	BIT	Uxy.08.E	HART Analog Input Module: CH3 process alarm lower limit
Input	XGF-AC4H_CH3_PALL	BIT	Uxy.08.F	HART Analog Input Module: CH3 process alarm LL
Input	XGF-AC4H_CH0_RAH	BIT	Uxy.09.0	HART Analog Input Module: CH0 Rate Alarm High limit
Input	XGF-AC4H_CH0_RAL	BIT	Uxy.09.1	HART Analog Input Module: CH0 Rate Alarm Lower limit
Input	XGF-AC4H_CH1_RAH	BIT	Uxy.09.2	HART Analog Input Module: CH1 Rate Alarm High limit
Input	XGF-AC4H_CH1_RAL	BIT	Uxy.09.3	HART Analog Input Module: CH1 Rate Alarm Lower limit
Input	XGF-AC4H_CH2_RAH	BIT	Uxy.09.4	HART Analog Input Module: CH2 Rate Alarm High limit
Input	XGF-AC4H_CH2_RAL	BIT	Uxy.09.5	HART Analog Input Module: CH2 Rate Alarm Lower limit
Input	XGF-AC4H_CH3_RAH	BIT	Uxy.09.6	HART Analog Input Module: CH3 Rate Alarm High limit
Input	XGF-AC4H_CH3_RAL	BIT	Uxy.09.7	HART Analog Input Module: CH3 Rate Alarm Lower limit
Input	XGF-AC4H_CH0_IDD	BIT	Uxy.10.0	HART Analog Input Module: CH0 input Disconnection Flag
Input	XGF-AC4H_CH1_IDD	BIT	Uxy.10.1	HART Analog Input Module: CH1 input disconnection detection
Input	XGF-AC4H_CH2_IDD	BIT	Uxy.10.2	HART Analog Input Module: CH2 input disconnection detection
Input	XGF-AC4H_CH3_IDD	BIT	Uxy.10.3	HART Analog Input Module: CH3 input disconnection detection
Input	XGF-	BIT	Uxy.10.8	HART Analog Input Module: Channel 0 HART Communication Error

	AC4H_CH0_HARTERR			Flag
Input	XGF-AC4H_CH1_HARTERR	BIT	Uxy.10.9	HART Analog Input Module: Channel 1 HART Communication Error Flag
Input	XGF-AC4H_CH2_HARTERR	BIT	Uxy.10.A	HART Analog Input Module: Channel 2 HART Communication Error Flag
Input	XGF-AC4H_CH3_HARTERR	BIT	Uxy.10.B	HART Analog Input Module: Channel 3 HART Communication Error Flag
Output	XGF-AC4H_ERR_CLR	BIT	Uxy.11.0	HART Analog Input Module: Error clear request
Input	XGF-AC4H_CH0_DATA	WORD	Uxy.02	HART Analog Input Module: CH0 conversion value
Input	XGF-AC4H_CH1_DATA	WORD	Uxy.03	HART Analog Input Module: CH1 conversion value
Input	XGF-AC4H_CH2_DATA	WORD	Uxy.04	HART Analog Input Module: CH2 conversion value
Input	XGF-AC4H_CH3_DATA	WORD	Uxy.05	HART Analog Input Module: CH3 conversion value

2) Refresh data

<Input>

Input/Output	Variable	type	Word(16BIT) Offset	Comment
Input	XGF-AC4H_ERR	BIT	0.0	HART Analog Input Module: Module error
Input	XGF-AC4H_RDY	BIT	0.F	HART Analog Input Module: Module ready
Input	XGF-AC4H_CH0_ACT	BIT	1.0	HART Analog Input Module: CH0 RUN
Input	XGF-AC4H_CH1_ACT	BIT	1.1	HART Analog Input Module: CH1 RUN
Input	XGF-AC4H_CH2_ACT	BIT	1.2	HART Analog Input Module: CH2 RUN
Input	XGF-AC4H_CH3_ACT	BIT	1.3	HART Analog Input Module: CH3 RUN
Input	XGF-AC4H_CH0_DATA	WORD	2	HART Analog Input Module: CH0 conversion value
Input	XGF-AC4H_CH1_DATA	WORD	3	HART Analog Input Module: CH1 conversion value
Input	XGF-AC4H_CH2_DATA	Word	4	HART Analog Input Module: CH2 conversion value
Input	XGF-AC4H_CH3_DATA	WORD	5	HART Analog Input Module: CH3 conversion value
Input	-	WORD	6	Reserved
Input	-	WORD	7	Reserved
Input	XGF-AC4H_CH0_PAHH	BIT	8.0	HART Analog Input Module: CH0 process alarm HH
Input	XGF-AC4H_CH0_PAH	BIT	8.1	HART Analog Input Module: CH0 process alarm H
Input	XGF-AC4H_CH0_PAL	BIT	8.2	HART Analog Input Module: CH0 process alarm lower limit
Input	XGF-AC4H_CH0_PALL	BIT	8.3	HART Analog Input Module: CH0 process alarm LL
Input	XGF-AC4H_CH1_PAHH	BIT	8.4	HART Analog Input Module: CH1 process alarm HH
Input	XGF-AC4H_CH1_PAH	BIT	8.5	HART Analog Input Module: CH1 process alarm H
Input	XGF-AC4H_CH1_PAL	BIT	8.6	HART Analog Input Module: CH1 process alarm lower limit
Input	XGF-AC4H_CH1_PALL	BIT	8.7	HART Analog Input Module: CH1 process alarm LL
Input	XGF-AC4H_CH2_PAHH	BIT	8.8	HART Analog Input Module: CH2 process alarm HH
Input	XGF-AC4H_CH2_PAH	BIT	8.9	HART Analog Input Module: CH2 process alarm H
Input	XGF-AC4H_CH2_PAL	BIT	8.A	HART Analog Input Module: CH2 process alarm lower limit
Input	XGF-AC4H_CH2_PALL	BIT	8.B	HART Analog Input Module: CH2 process alarm LL
Input	XGF-AC4H_CH3_PAHH	BIT	8.C	HART Analog Input Module: CH3 process alarm HH
Input	XGF-AC4H_CH3_PAH	BIT	8.D	HART Analog Input Module: CH3 process alarm H
Input	XGF-AC4H_CH3_PAL	BIT	8.E	HART Analog Input Module: CH3 process alarm lower limit
Input	XGF-AC4H_CH3_PALL	BIT	8.F	HART Analog Input Module: CH3 process alarm LL
Input	XGF-AC4H_CH0_RAHH	BIT	9.0	HART Analog Input Module: CH0 Rate Alarm High limit
Input	XGF-AC4H_CH0_RAL	BIT	9.1	HART Analog Input Module: CH0 Rate Alarm Lower limit
Input	XGF-AC4H_CH1_RAHH	BIT	9.2	HART Analog Input Module: CH1 Rate Alarm High limit

Appendix

Input	XGF-AC4H_CH1_RAL	BIT	9.3	HART Analog Input Module: CH1 Rate Alarm Lower limit
Input	XGF-AC4H_CH2_RAHA	BIT	9.4	HART Analog Input Module: CH2 Rate Alarm High limit
Input	XGF-AC4H_CH2_RAL	BIT	9.5	HART Analog Input Module: CH2 Rate Alarm Lower limit
Input	XGF-AC4H_CH3_RAHA	BIT	9.6	HART Analog Input Module: CH3 Rate Alarm High limit
Input	XGF-AC4H_CH3_RAL	BIT	9.7	HART Analog Input Module: CH3 Rate Alarm Lower limit
Input	XGF-AC4H_CH0_IDD	BIT	10.0	HART Analog Input Module: CH0 input Disconnection Flag
Input	XGF-AC4H_CH1_IDD	BIT	10.1	HART Analog Input Module: CH1 input disconnection detection
Input	XGF-AC4H_CH2_IDD	BIT	10.2	HART Analog Input Module: CH2 input disconnection detection
Input	XGF-AC4H_CH3_IDD	BIT	10.3	HART Analog Input Module: CH3 input disconnection detection
Input	XGF-AC4H_CH0_HARTERR	BIT	10.8	HART Analog Input Module: Channel 0 HART Communication Error Flag
Input	XGF-AC4H_CH1_HARTERR	BIT	10.9	HART Analog Input Module: Channel 1 HART Communication Error Flag
Input	XGF-AC4H_CH2_HARTERR	BIT	10.A	HART Analog Input Module: Channel 2 HART Communication Error Flag
Input	XGF-AC4H_CH3_HARTERR	BIT	10.B	HART Analog Input Module: Channel 3 HART Communication Error Flag

<Output>

Input/Output	Variable	type	Word(16BIT) Offset	Comment
Output	XGF-AC4H_ERR_CLR	BIT	0.0	HART Analog Input Module: Error clear request

(15) XGF-DC4H

1) U Device

Input/Output	Variable	Type	Device	Comment
Input	XGF-DC4H_CH0_ERR	BIT	Uxy.00.0	HART Analog output module: Channel 0 error
Input	XGF-DC4H_CH1_ERR	BIT	Uxy.00.1	HART Analog output module: Channel 1 error
Input	XGF-DC4H_CH2_ERR	BIT	Uxy.00.2	HART Analog output module: Channel 2 error
Input	XGF-DC4H_CH3_ERR	BIT	Uxy.00.3	HART Analog output module: Channel 3 error
Input	XGF-DC4H_CH0_HARTERR	BIT	Uxy.00.8	HART Analog output module: Channel 0 HART Communication Error Flag
Input	XGF-DC4H_CH1_HARTERR	BIT	Uxy.00.9	HART Analog output module: Channel 1 HART Communication Error Flag
Input	XGF-DC4H_CH2_HARTERR	BIT	Uxy.00.A	HART Analog output module: Channel 2 HART Communication Error Flag
Input	XGF-DC4H_CH3_HARTERR	BIT	Uxy.00.B	HART Analog output module: Channel 3 HART Communication Error Flag
Input	XGF-DC4H_RDY	BIT	Uxy.00.F	HART Analog output module: Module ready
Input	XGF-DC4H_CH0_ACT	BIT	Uxy.01.0	HART Analog output module: CH0 RUN
Input	XGF-DC4H_CH1_ACT	BIT	Uxy.01.1	HART Analog output module: CH1 RUN
Input	XGF-DC4H_CH2_ACT	BIT	Uxy.01.2	HART Analog output module: CH2 RUN
Input	XGF-DC4H_CH3_ACT	BIT	Uxy.01.3	HART Analog output module: CH3 RUN
Input	XGF-DC4H_CH0_OUTH	BIT	Uxy.01.8	HART Analog output module: Channel 0 output high limit
Input	XGF-DC4H_CH0_OUTL	BIT	Uxy.01.9	HART Analog output module: Channel 0 output lower limit
Input	XGF-DC4H_CH1_OUTH	BIT	Uxy.01.A	HART Analog output module: Channel 1 output high limit
Input	XGF-DC4H_CH1_OUTL	BIT	Uxy.01.B	HART Analog output module: Channel 1 output lower limit
Input	XGF-DC4H_CH2_OUTH	BIT	Uxy.01.C	HART Analog output module: Channel 2 output high limit
Input	XGF-DC4H_CH2_OUTL	BIT	Uxy.01.D	HART Analog output module: Channel 2 output lower limit

Input	XGF-DC4H_CH3_OUTH	BIT	Uxy.01.E	HART Analog output module: Channel 3 output high limit
Input	XGF-DC4H_CH3_OUTL	BIT	Uxy.01.F	HART Analog output module: Channel 3 output lower limit
Output	XGF-DC4H_CH0_OUTEN	BIT	Uxy.02.0	HART Analog output module: Channel 0 output status setting
Output	XGF-DC4H_CH1_OUTEN	BIT	Uxy.02.1	HART Analog output module: Channel 1 output status setting
Output	XGF-DC4H_CH2_OUTEN	BIT	Uxy.02.2	HART Analog output module: Channel 2 output status setting
Output	XGF-DC4H_CH3_OUTEN	BIT	Uxy.02.3	HART Analog output module: Channel 3 output status setting
Output	XGF-DC4H_CH0_DATA	Word	Uxy.03	HART Analog output module: Channel 0 Input value
Output	XGF-DC4H_CH1_DATA	Word	Uxy.04	HART Analog output module: Channel 1 Input value
Output	XGF-DC4H_CH2_DATA	Word	Uxy.05	HART Analog output module: Channel 2 Input value
Output	XGF-DC4H_CH3_DATA	Word	Uxy.06	HART Analog output module: Channel 3 Input value

2) Refresh data

<Input>

Input/Output	Variable	Type	Word(16BIT) Offset	Comment
Input	XGF-DC4H_CH0_ERR	BIT	0.0	HART Analog output module: Channel 0 error
Input	XGF-DC4H_CH1_ERR	BIT	0.1	HART Analog output module: Channel 1 error
Input	XGF-DC4H_CH2_ERR	BIT	0.2	HART Analog output module: Channel 2 error
Input	XGF-DC4H_CH3_ERR	BIT	0.3	HART Analog output module: Channel 3 error
Input	XGF-DC4H_CH0_HARTERR	BIT	0.8	HART Analog output module: Channel 0 HART Communication Error Flag
Input	XGF-DC4H_CH1_HARTERR	BIT	0.9	HART Analog output module: Channel 1 HART Communication Error Flag
Input	XGF-DC4H_CH2_HARTERR	BIT	0.A	HART Analog output module: Channel 2 HART Communication Error Flag
Input	XGF-DC4H_CH3_HARTERR	BIT	0.B	HART Analog output module: Channel 3 HART Communication Error Flag
Input	XGF-DC4H_RDY	BIT	0.F	HART Analog output module: Module ready
Input	XGF-DC4H_CH0_ACT	BIT	1.0	HART Analog output module: CH0 RUN
Input	XGF-DC4H_CH1_ACT	BIT	1.1	HART Analog output module: CH1 RUN
Input	XGF-DC4H_CH2_ACT	BIT	1.2	HART Analog output module: CH2 RUN
Input	XGF-DC4H_CH3_ACT	BIT	1.3	HART Analog output module: CH3 RUN
Input	XGF-DC4H_CH0_OUTH	BIT	1.8	HART Analog output module: Channel 0 output high limit
Input	XGF-DC4H_CH0_OUTL	BIT	1.9	HART Analog output module: Channel 0 output lower limit
Input	XGF-DC4H_CH1_OUTH	BIT	1.A	HART Analog output module: Channel 1 output high limit
Input	XGF-DC4H_CH1_OUTL	BIT	1.B	HART Analog output module: Channel 1 output lower limit
Input	XGF-DC4H_CH2_OUTH	BIT	1.C	HART Analog output module: Channel 2 output high limit
Input	XGF-DC4H_CH2_OUTL	BIT	1.D	HART Analog output module: Channel 2 output lower limit
Input	XGF-DC4H_CH3_OUTH	BIT	1.E	HART Analog output module: Channel 3 output high limit
Input	XGF-DC4H_CH3_OUTL	BIT	1.F	HART Analog output module: Channel 3 output lower limit

<Output>

Input/Output	Variable	Type	Word(16BIT) Offset	Comment
Output	XGF-DC4H_CH0_OUTEN	BIT	0.0	HART Analog output module: Channel 0 output status setting
Output	XGF-DC4H_CH1_OUTEN	BIT	0.1	HART Analog output module: Channel 1 output status setting

Appendix

Output	XGF-DC4H_CH2_OUTEN	BIT	0.2	HART Analog output module: Channel 2 output status setting
Output	XGF-DC4H_CH3_OUTEN	BIT	0.3	HART Analog output module: Channel 3 output status setting
Output	XGF-DC4H_CH0_DATA	Word	1	HART Analog output module: Channel 0 Input value
Output	XGF-DC4H_CH1_DATA	Word	2	HART Analog output module: Channel 1 Input value
Output	XGF-DC4H_CH2_DATA	Word	3	HART Analog output module: Channel 2 Input value
Output	XGF-DC4H_CH3_DATA	Word	4	HART Analog output module: Channel 3 Input value
Output		WORD	5	Reserved
Output		WORD	6	Reserved
Output		WORD	7	Reserved
Output		WORD	8	Reserved
Output		WORD	9	Reserved

(16) XGF-HO2A

1) U Device

Input/Output	Variable	Type	Device	Comment
Input	XGF-HO2A_CH0_DN	BIT	Uxy.00.0	High Speed Counter Module: CH0 up/down counter status flag
Input	XGF-HO2A_CH0_EXTPRE	BIT	Uxy.00.1	High Speed Counter Module: Channel 0 external preset command detection flag
Input	XGF-HO2A_CH0_CRY	BIT	Uxy.00.3	High Speed Counter Module: Channel 0 carry value
Input	XGF-HO2A_CH0_BRW	BIT	Uxy.00.4	High Speed Counter Module: Channel 0 borrow value
Input	XGF-HO2A_CH0_AUXING	BIT	Uxy.00.5	High Speed Counter Module: Channel 0 auxiliary function status
Input	XGF-HO2A_CH0_CMPOUT0	BIT	Uxy.00.6	High Speed Counter Module: Channel 0 compare output 0 status
Input	XGF-HO2A_CH0_CMPOUT1	BIT	Uxy.00.7	High Speed Counter Module: Channel 0 compare output 1 status
Input	XGF-HO2A_CH0_ERR	BIT	Uxy.00.E	High Speed Counter Module: Channel 0 error flag
Input	XGF-HO2A_RDY	BIT	Uxy.00.F	High Speed Counter Module: Module ready
Input	XGF-HO2A_CH1_DN	BIT	Uxy.01.0	High Speed Counter Module: CH1 up/down counter status flag
Input	XGF-HO2A_CH1_EXTPRE	BIT	Uxy.01.1	High Speed Counter Module: Channel 1 external preset command detection flag
Input	XGF-HO2A_CH1_CRY	BIT	Uxy.01.3	High Speed Counter Module: Channel 1 carry value
Input	XGF-HO2A_CH1_BRW	BIT	Uxy.01.4	High Speed Counter Module: Channel 1 borrow value
Input	XGF-HO2A_CH1_AUXING	BIT	Uxy.01.5	High Speed Counter Module: Channel 1 auxiliary function status
Input	XGF-HO2A_CH1_CMPOUT0	BIT	Uxy.01.6	High Speed Counter Module: Channel 1 compare output 0 status
Input	XGF-HO2A_CH1_CMPOUT1	BIT	Uxy.01.7	High Speed Counter Module: Channel 1 compare output 1 status
Input	XGF-HO2A_CH1_ERR	BIT	Uxy.01.E	High Speed Counter Module: Channel 1 error flag
Output	XGF-HO2A_CH0_CNTEN	BIT	Uxy.23.0	High Speed Counter Module: Channel 0 enable counter command(level)
Output	XGF-HO2A_CH0_PREEN	BIT	Uxy.23.1	High Speed Counter Module: Channel 0 enable preset command(Edge)
Output	XGF-HO2A_CH0_DWNCNT	BIT	Uxy.23.2	High Speed Counter Module: Channel 0 up/down counter select command(Level)

Output	XGF-HO2A_CH0_AUXEN	BIT	Uxy.23.3	High Speed Counter Module: Channel 0 auxiliary function request(Edge,Level)
Output	XGF-HO2A_CH0_CMPEN	BIT	Uxy.23.4	High Speed Counter Module: Channel 0 compare function enable command(Level)
Output	XGF-HO2A_CH0_OUTEN	BIT	Uxy.23.5	High Speed Counter Module: Channel 0 compare output signal enable command(Level)
Output	XGF-HO2A_CH0_EQ0RST	BIT	Uxy.23.6	High Speed Counter Module: Channel 0 compare output 0 equal reset command (Edge)
Output	XGF-HO2A_CH0_EQ1RST	BIT	Uxy.23.7	High Speed Counter Module: Channel 0 compare output 1 equal reset command (Edge)
Output	XGF-HO2A_CH0_CRYBRW_RST	BIT	Uxy.23.A	High Speed Counter Module: Channel 0 carry/borrow reset command(Edge)
Output	XGF-HO2A_CH0_EXTPST_EN	BIT	Uxy.23.B	High Speed Counter Module: Channel 0 preset Ext. Input enable command
Output	XGF-HO2A_CH0_EXTAUX_EN	BIT	Uxy.23.C	High Speed Counter Module: Channel 0 auxiliary function Ext. input enable command
Output	XGF-HO2A_CH0_EXTPST_RST	BIT	Uxy.23.D	High Speed Counter Module: Channel 0 Ext. Input preset reset command
Output	XGF-HO2A_CH1_CNTEN	BIT	Uxy.24.0	High Speed Counter Module: Channel 1 enable counter command(level)
Output	XGF-HO2A_CH1_PREEN	BIT	Uxy.24.1	High Speed Counter Module: Channel 1 enable preset command(Edge)
Output	XGF-HO2A_CH1_DWNCNT	BIT	Uxy.24.2	High Speed Counter Module: Channel 1 up/down counter select command(Level)
Output	XGF-HO2A_CH1_AUXEN	BIT	Uxy.24.3	High Speed Counter Module: Channel 1 auxiliary function enable command(Edge,Level)
Output	XGF-HO2A_CH1_CMPEN	BIT	Uxy.24.4	High Speed Counter Module: Channel 1 compare function enable command(Level)
Output	XGF-HO2A_CH1_OUTEN	BIT	Uxy.24.5	High Speed Counter Module: Channel 1 compare output signal enable command(Level)
Output	XGF-HO2A_CH1_EQ0RST	BIT	Uxy.24.6	High Speed Counter Module: Channel 0 compare output 0 equal reset command (Edge)
Output	XGF-HO2A_CH1_EQ1RST	BIT	Uxy.24.7	High Speed Counter Module: Channel 1 compare output 0 equal reset command (Edge)
Output	XGF-HO2A_CH1_CRYBRW_RST	BIT	Uxy.24.A	High Speed Counter Module: Channel 1 carry/borrow reset command(Edge)
Output	XGF-HO2A_CH1_EXTPST_EN	BIT	Uxy.24.B	High Speed Counter Module: Channel 1 preset Ext. Input enable command
Output	XGF-HO2A_CH1_EXTAUX_EN	BIT	Uxy.24.C	High Speed Counter Module: Channel 1 auxiliary Ext. Input enable command
Output	XGF-HO2A_CH1_EXTPST_RST	BIT	Uxy.24.D	High Speed Counter Module: Channel 1 Ext. Input preset reset command
Input	XGF-HO2A_CH0_CNT_LV	Word	Uxy.02	High Speed Counter Module: Channel 0 count value (LWORD)
Input	XGF-HO2A_CH0_CNT_HV	Word	Uxy.03	High Speed Counter Module: Channel 0 count value (HWORD)
Input	XGF-HO2A_CH0_LTH_LV	Word	Uxy.04	High Speed Counter Module: Channel 0 latch count value (LWORD)
Input	XGF-HO2A_CH0_LTH_HV	Word	Uxy.05	High Speed Counter Module: Channel 0 latch count value

Appendix

				(HWORD)
Input	XGF-HO2A_CH0_RNG_LV	Word	Uxy.06	High Speed Counter Module: Channel 0 sampling count value (LWORD)
Input	XGF-HO2A_CH0_RNG_HV	Word	Uxy.07	High Speed Counter Module: Channel 0 sampling count value (HWORD)
Input	XGF-HO2A_CH0_FRQ_LV	Word	Uxy.08	High Speed Counter Module: Channel 0 input frequency value (LWORD)
Input	XGF-HO2A_CH0_FRQ_HV	Word	Uxy.09	High Speed Counter Module: Channel 0 input frequency value (HWORD)
Input	XGF-HO2A_CH0_RPU_LV	Word	Uxy.10	High Speed Counter Module: Channel 0 Rev./unit time value (LWORD)
Input	XGF-HO2A_CH0_RPU_HV	Word	Uxy.11	High Speed Counter Module: Channel 0 Rev./unit time value (HWORD)
Input	XGF-HO2A_CH1_CNT_LV	Word	Uxy.12	High Speed Counter Module: Channel 1 count value (LWORD)
Input	XGF-HO2A_CH1_CNT_HV	Word	Uxy.13	High Speed Counter Module: Channel 1 count value (HWORD)
Input	XGF-HO2A_CH1_LTH_LV	Word	Uxy.14	High Speed Counter Module: Channel 1 latch count value (LWORD)
Input	XGF-HO2A_CH1_LTH_HV	Word	Uxy.15	High Speed Counter Module: Channel 1 latch count value (HWORD)
Input	XGF-HO2A_CH1_RNG_LV	Word	Uxy.16	High Speed Counter Module: Channel 1 sampling count value (LWORD)
Input	XGF-HO2A_CH1_RNG_HV	Word	Uxy.17	High Speed Counter Module: Channel 1 sampling count value (HWORD)
Input	XGF-HO2A_CH1_FRQ_LV	Word	Uxy.18	High Speed Counter Module: Channel 1 input frequency value (LWORD)
Input	XGF-HO2A_CH1_FRQ_HV	Word	Uxy.19	High Speed Counter Module: Channel 1 input frequency value (HWORD)
Input	XGF-HO2A_CH1_RPU_LV	Word	Uxy.20	High Speed Counter Module: Channel 1 Rev./unit time value (LWORD)
Input	XGF-HO2A_CH1_RPU_HV	Word	Uxy.21	High Speed Counter Module: Channel 1 Rev./unit time value (HWORD)

2) Refresh data

<Input>

Input/Output	Variable	Type	Word(16BIT) Offset	Comment
Input	XGF-HO2A_CH0_DN	BIT	0.0	High Speed Counter Module: CH0 up/down counter status flag
Input	XGF-HO2A_CH0_EXTPRE	BIT	0.1	High Speed Counter Module: Channel 0 external preset command detection flag
Input	XGF-HO2A_CH0_CRY	BIT	0.3	High Speed Counter Module: Channel 0 carry value
Input	XGF-HO2A_CH0_BRW	BIT	0.4	High Speed Counter Module: Channel 0 borrow value
Input	XGF-HO2A_CH0_AUXING	BIT	0.5	High Speed Counter Module: Channel 0 auxiliary function status
Input	XGF-HO2A_CH0_CMPOUT0	BIT	0.6	High Speed Counter Module: Channel 0 compare output 0 status
Input	XGF-	BIT	0.7	High Speed Counter Module: Channel 0 compare output

	HO2A_CH0_CMPOUT1			1 status
Input	XGF-HO2A_CH0_ERR	BIT	0.E	High Speed Counter Module: Channel 0 error flag
Input	XGF-HO2A_RDY	BIT	0.F	High Speed Counter Module: Module ready
Input	XGF-HO2A_CH1_DN	BIT	1.0	High Speed Counter Module: CH1 up/down counter status flag
Input	XGF-HO2A_CH1_EXTPRE	BIT	1.1	High Speed Counter Module: Channel 1 external preset command detection flag
Input	XGF-HO2A_CH1_CRY	BIT	1.3	High Speed Counter Module: Channel 1 carry value
Input	XGF-HO2A_CH1_BRW	BIT	1.4	High Speed Counter Module: Channel 1 borrow value
Input	XGF-HO2A_CH1_AUXING	BIT	1.5	High Speed Counter Module: Channel 1 auxiliary function status
Input	XGF-HO2A_CH1_CMPOUT0	BIT	1.6	High Speed Counter Module: Channel 1 compare output 0 status
Input	XGF-HO2A_CH1_CMPOUT1	BIT	1.7	High Speed Counter Module: Channel 1 compare output 1 status
Input	XGF-HO2A_CH1_ERR	BIT	1.E	High Speed Counter Module: Channel 1 error flag
Input	XGF-HO2A_CH0_CNT_LV	Word	2	High Speed Counter Module: Channel 0 count value (LWORD)
Input	XGF-HO2A_CH0_CNT_HV	Word	3	High Speed Counter Module: Channel 0 count value (HWORD)
Input	XGF-HO2A_CH0_LTH_LV	Word	4	High Speed Counter Module: Channel 0 latch count value (LWORD)
Input	XGF-HO2A_CH0_LTH_HV	Word	5	High Speed Counter Module: Channel 0 latch count value (HWORD)
Input	XGF-HO2A_CH0_RNG_LV	Word	6	High Speed Counter Module: Channel 0 sampling count value (LWORD)
Input	XGF-HO2A_CH0_RNG_HV	Word	7	High Speed Counter Module: Channel 0 sampling count value (HWORD)
Input	XGF-HO2A_CH0_FRQ_LV	Word	8	High Speed Counter Module: Channel 0 input frequency value (LWORD)
Input	XGF-HO2A_CH0_FRQ_HV	Word	9	High Speed Counter Module: Channel 0 input frequency value (HWORD)
Input	XGF-HO2A_CH0_RPU_LV	Word	10	High Speed Counter Module: Channel 0 Rev./unit time value (LWORD)
Input	XGF-HO2A_CH0_RPU_HV	Word	11	High Speed Counter Module: Channel 0 Rev./unit time value (HWORD)
Input	XGF-HO2A_CH1_CNT_LV	Word	12	High Speed Counter Module: Channel 1 count value (LWORD)
Input	XGF-HO2A_CH1_CNT_HV	Word	13	High Speed Counter Module: Channel 1 count value (HWORD)
Input	XGF-HO2A_CH1_LTH_LV	Word	14	High Speed Counter Module: Channel 1 latch count value (LWORD)
Input	XGF-HO2A_CH1_LTH_HV	Word	15	High Speed Counter Module: Channel 1 latch count value (HWORD)
Input	XGF-HO2A_CH1_RNG_LV	Word	16	High Speed Counter Module: Channel 1 sampling count value (LWORD)
Input	XGF-HO2A_CH1_RNG_HV	Word	17	High Speed Counter Module: Channel 1 sampling count value (HWORD)
Input	XGF-HO2A_CH1_FRQ_LV	Word	18	High Speed Counter Module: Channel 1 input frequency

Appendix

				value (LWORD)
Input	XGF-HO2A_CH1_FRQ_HV	Word	19	High Speed Counter Module: Channel 1 input frequency value (HWORD)
Input	XGF-HO2A_CH1_RPU_LV	Word	20	High Speed Counter Module: Channel 1 Rev./unit time value (LWORD)
Input	XGF-HO2A_CH1_RPU_HV	Word	21	High Speed Counter Module: Channel 1 Rev./unit time value (HWORD)
Input		WORD	22	Reserved

<Output>

Input/Output	Variable	Type	Word(16BIT) Offset	Comment
Output	XGF-HO2A_CH0_CNTEN	BIT	0.0	High Speed Counter Module: Channel 0 enable counter command(level)
Output	XGF-HO2A_CH0_PREEN	BIT	0.1	High Speed Counter Module: Channel 0 enable preset command(Edge)
Output	XGF-HO2A_CH0_DWNCNT	BIT	0.2	High Speed Counter Module: Channel 0 up/down counter select command(Level)
Output	XGF-HO2A_CH0_AUXEN	BIT	0.3	High Speed Counter Module: Channel 0 auxiliary function request(Edge,Level)
Output	XGF-HO2A_CH0_CMPEN	BIT	0.4	High Speed Counter Module: Channel 0 compare function enable command(Level)
Output	XGF-HO2A_CH0_OUTEN	BIT	0.5	High Speed Counter Module: Channel 0 compare output signal enable command(Level)
Output	XGF-HO2A_CH0_EQ0RST	BIT	0.6	High Speed Counter Module: Channel 0 compare output 0 equal reset command (Edge)
Output	XGF-HO2A_CH0_EQ1RST	BIT	0.7	High Speed Counter Module: Channel 0 compare output 1 equal reset command (Edge)
Output	XGF-HO2A_CH0_CRYBRW_RST	BIT	0.A	High Speed Counter Module: Channel 0 carry/borrow reset command(Edge)
Output	XGF-HO2A_CH0_EXTPST_EN	BIT	0.B	High Speed Counter Module: Channel 0 preset Ext. Input enable command
Output	XGF-HO2A_CH0_EXTAUX_EN	BIT	0.C	High Speed Counter Module: Channel 0 auxiliary function Ext. input enable command
Output	XGF-HO2A_CH0_EXTPST_RST	BIT	0.D	High Speed Counter Module: Channel 0 Ext. Input preset reset command
Output	XGF-HO2A_CH1_CNTEN	BIT	1.0	High Speed Counter Module: Channel 1 enable counter command(level)
Output	XGF-HO2A_CH1_PREEN	BIT	1.1	High Speed Counter Module: Channel 1 enable preset command(Edge)
Output	XGF-HO2A_CH1_DWNCNT	BIT	1.2	High Speed Counter Module: Channel 1 up/down counter select command(Level)
Output	XGF-HO2A_CH1_AUXEN	BIT	1.3	High Speed Counter Module: Channel 1 auxiliary function enable command(Edge,Level)
Output	XGF-HO2A_CH1_CMPEN	BIT	1.4	High Speed Counter Module: Channel 1 compare function enable command(Level)
Output	XGF-HO2A_CH1_OUTEN	BIT	1.5	High Speed Counter Module: Channel 1 compare output signal enable command(Level)
Output	XGF-HO2A_CH1_EQ0RST	BIT	1.6	High Speed Counter Module: Channel 0 compare output 0 equal reset command (Edge)

Output	XGF-HO2A_CH1_EQ1RST	BIT	1.7	High Speed Counter Module: Channel 1 compare output 0 equal reset command (Edge)
Output	XGF-HO2A_CH1_CRYBRW_RST	BIT	1.A	High Speed Counter Module: Channel 1 carry/borrow reset command(Edge)
Output	XGF-HO2A_CH1_EXTPST_EN	BIT	1.B	High Speed Counter Module: Channel 1 preset Ext. Input enable command
Output	XGF-HO2A_CH1_EXTAUX_EN	BIT	1.C	High Speed Counter Module: Channel 1 auxiliary Ext. Input enable command
Output	XGF-HO2A_CH1_EXTPST_RST	BIT	1.D	High Speed Counter Module: Channel 1 Ext. Input preset reset command

(17) XGF-HD2A

1) U Device

Input/Output	Variable	Type	Device	Comment
Input	XGF-HD2A_CH0_DN	BIT	Uxy.00.0	High Speed Counter Module: CH0 up/down counter status flag
Input	XGF-HD2A_CH0_EXTPRE	BIT	Uxy.00.1	High Speed Counter Module: Channel 0 external preset command detection flag
Input	XGF-HD2A_CH0_CRY	BIT	Uxy.00.3	High Speed Counter Module: Channel 0 carry value
Input	XGF-HD2A_CH0_BRW	BIT	Uxy.00.4	High Speed Counter Module: Channel 0 borrow value
Input	XGF-HD2A_CH0_AUXING	BIT	Uxy.00.5	High Speed Counter Module: Channel 0 auxiliary function status
Input	XGF-HD2A_CH0_CMPOUT0	BIT	Uxy.00.6	High Speed Counter Module: Channel 0 compare output 0 status
Input	XGF-HD2A_CH0_CMPOUT1	BIT	Uxy.00.7	High Speed Counter Module: Channel 0 compare output 1 status
Input	XGF-HD2A_CH0_ERR	BIT	Uxy.00.E	High Speed Counter Module: Channel 0 error flag
Input	XGF-HD2A_RDY	BIT	Uxy.00.F	High Speed Counter Module: Module ready
Input	XGF-HD2A_CH1_DN	BIT	Uxy.01.0	High Speed Counter Module: CH1 up/down counter status flag
Input	XGF-HD2A_CH1_EXTPRE	BIT	Uxy.01.1	High Speed Counter Module: Channel 1 external preset command detection flag
Input	XGF-HD2A_CH1_CRY	BIT	Uxy.01.3	High Speed Counter Module: Channel 1 carry value
Input	XGF-HD2A_CH1_BRW	BIT	Uxy.01.4	High Speed Counter Module: Channel 1 borrow value
Input	XGF-HD2A_CH1_AUXING	BIT	Uxy.01.5	High Speed Counter Module: Channel 1 auxiliary function status
Input	XGF-HD2A_CH1_CMPOUT0	BIT	Uxy.01.6	High Speed Counter Module: Channel 1 compare output 0 status
Input	XGF-HD2A_CH1_CMPOUT1	BIT	Uxy.01.7	High Speed Counter Module: Channel 1 compare output 1 status
Input	XGF-HD2A_CH1_ERR	BIT	Uxy.01.E	High Speed Counter Module: Channel 1 error flag
Output	XGF-HD2A_CH0_CNTEN	BIT	Uxy.23.0	High Speed Counter Module: Channel 0 enable counter command(level)
Output	XGF-HD2A_CH0_PREEN	BIT	Uxy.23.1	High Speed Counter Module: Channel 0 enable preset command(Edge)
Output	XGF-HD2A_CH0_DWNCNT	BIT	Uxy.23.2	High Speed Counter Module: Channel 0 up/down counter select command(Level)
Output	XGF-HD2A_CH0_AUXEN	BIT	Uxy.23.3	High Speed Counter Module: Channel 0 auxiliary function

Appendix

				request(Edge,Level)
Output	XGF-HD2A_CH0_CMPEN	BIT	Uxy.23.4	High Speed Counter Module: Channel 0 compare function enable command(Level)
Output	XGF-HD2A_CH0_OUTEN	BIT	Uxy.23.5	High Speed Counter Module: Channel 0 compare output signal enable command(Level)
Output	XGF-HD2A_CH0_EQ0RST	BIT	Uxy.23.6	High Speed Counter Module: Channel 0 compare output 0 equal reset command (Edge)
Output	XGF-HD2A_CH0_EQ1RST	BIT	Uxy.23.7	High Speed Counter Module: Channel 0 compare output 1 equal reset command (Edge)
Output	XGF-HD2A_CH0_CRYBRW_RST	BIT	Uxy.23.A	High Speed Counter Module: Channel 0 carry/borrow reset command(Edge)
Output	XGF-HD2A_CH0_EXTPST_EN	BIT	Uxy.23.B	High Speed Counter Module: Channel 0 preset Ext. Input enable command
Output	XGF-HD2A_CH0_EXTAUX_EN	BIT	Uxy.23.C	High Speed Counter Module: Channel 0 auxiliary function Ext. input enable command
Output	XGF-HD2A_CH0_EXTPST_RST	BIT	Uxy.23.D	High Speed Counter Module: Channel 0 Ext. Input preset reset command
Output	XGF-HD2A_CH1_CNTEN	BIT	Uxy.24.0	High Speed Counter Module: Channel 1 enable counter command(level)
Output	XGF-HD2A_CH1_PREEN	BIT	Uxy.24.1	High Speed Counter Module: Channel 1 enable preset command(Edge)
Output	XGF-HD2A_CH1_DWNCNT	BIT	Uxy.24.2	High Speed Counter Module: Channel 1 up/down counter select command(Level)
Output	XGF-HD2A_CH1_AUXEN	BIT	Uxy.24.3	High Speed Counter Module: Channel 1 auxiliary function enable command(Edge,Level)
Output	XGF-HD2A_CH1_CMPEN	BIT	Uxy.24.4	High Speed Counter Module: Channel 1 compare function enable command(Level)
Output	XGF-HD2A_CH1_OUTEN	BIT	Uxy.24.5	High Speed Counter Module: Channel 1 compare output signal enable command(Level)
Output	XGF-HD2A_CH1_EQ0RST	BIT	Uxy.24.6	High Speed Counter Module: Channel 0 compare output 0 equal reset command (Edge)
Output	XGF-HD2A_CH1_EQ1RST	BIT	Uxy.24.7	High Speed Counter Module: Channel 1 compare output 0 equal reset command (Edge)
Output	XGF-HD2A_CH1_CRYBRW_RST	BIT	Uxy.24.A	High Speed Counter Module: Channel 1 carry/borrow reset command(Edge)
Output	XGF-HD2A_CH1_EXTPST_EN	BIT	Uxy.24.B	High Speed Counter Module: Channel 1 preset Ext. Input enable command
Output	XGF-HD2A_CH1_EXTAUX_EN	BIT	Uxy.24.C	High Speed Counter Module: Channel 1 auxiliary Ext. Input enable command
Output	XGF-HD2A_CH1_EXTPST_RST	BIT	Uxy.24.D	High Speed Counter Module: Channel 1 Ext. Input preset reset command
Input	XGF-HD2A_CH0_CNT_LV	Word	Uxy.02	High Speed Counter Module: Channel 0 count value (LWORD)
Input	XGF-HD2A_CH0_CNT_HV	Word	Uxy.03	High Speed Counter Module: Channel 0 count value (HWORD)
Input	XGF-HD2A_CH0_LTH_LV	Word	Uxy.04	High Speed Counter Module: Channel 0 latch count value (LWORD)
Input	XGF-HD2A_CH0_LTH_HV	Word	Uxy.05	High Speed Counter Module: Channel 0 latch count value (HWORD)

Input	XGF-HD2A_CH0_RNG_LV	Word	Uxy.06	High Speed Counter Module: Channel 0 sampling count value (LWORD)
Input	XGF-HD2A_CH0_RNG_HV	Word	Uxy.07	High Speed Counter Module: Channel 0 sampling count value (HWORD)
Input	XGF-HD2A_CH0_FRQ_LV	Word	Uxy.08	High Speed Counter Module: Channel 0 input frequency value (LWORD)
Input	XGF-HD2A_CH0_FRQ_HV	Word	Uxy.09	High Speed Counter Module: Channel 0 input frequency value (HWORD)
Input	XGF-HD2A_CH0_RPU_LV	Word	Uxy.10	High Speed Counter Module: Channel 0 Rev./unit time value (LWORD)
Input	XGF-HD2A_CH0_RPU_HV	Word	Uxy.11	High Speed Counter Module: Channel 0 Rev./unit time value (HWORD)
Input	XGF-HD2A_CH1_CNT_LV	Word	Uxy.12	High Speed Counter Module: Channel 1 count value (LWORD)
Input	XGF-HD2A_CH1_CNT_HV	Word	Uxy.13	High Speed Counter Module: Channel 1 count value (HWORD)
Input	XGF-HD2A_CH1_LTH_LV	Word	Uxy.14	High Speed Counter Module: Channel 1 latch count value (LWORD)
Input	XGF-HD2A_CH1_LTH_HV	Word	Uxy.15	High Speed Counter Module: Channel 1 latch count value (HWORD)
Input	XGF-HD2A_CH1_RNG_LV	Word	Uxy.16	High Speed Counter Module: Channel 1 sampling count value (LWORD)
Input	XGF-HD2A_CH1_RNG_HV	Word	Uxy.17	High Speed Counter Module: Channel 1 sampling count value (HWORD)
Input	XGF-HD2A_CH1_FRQ_LV	Word	Uxy.18	High Speed Counter Module: Channel 1 input frequency value (LWORD)
Input	XGF-HD2A_CH1_FRQ_HV	Word	Uxy.19	High Speed Counter Module: Channel 1 input frequency value (HWORD)
Input	XGF-HD2A_CH1_RPU_LV	Word	Uxy.20	High Speed Counter Module: Channel 1 Rev./unit time value (LWORD)
Input	XGF-HD2A_CH1_RPU_HV	Word	Uxy.21	High Speed Counter Module: Channel 1 Rev./unit time value (HWORD)

2) Refresh data

<Input>

Input/Output	Variable	Type	Word(16BIT) Offset	Comment
Input	XGF-HD2A_CH0_DN	BIT	0.0	High Speed Counter Module: CH0 up/down counter status flag
Input	XGF-HD2A_CH0_EXTPRE	BIT	0.1	High Speed Counter Module: Channel 0 external preset command detection flag
Input	XGF-HD2A_CH0_CRY	BIT	0.3	High Speed Counter Module: Channel 0 carry value
Input	XGF-HD2A_CH0_BRW	BIT	0.4	High Speed Counter Module: Channel 0 borrow value
Input	XGF-HD2A_CH0_AUXING	BIT	0.5	High Speed Counter Module: Channel 0 auxiliary function status
Input	XGF-HD2A_CH0_CMPOUT0	BIT	0.6	High Speed Counter Module: Channel 0 compare output 0 status
Input	XGF-HD2A_CH0_CMPOUT1	BIT	0.7	High Speed Counter Module: Channel 0 compare output 1 status

Appendix

Input	XGF-HD2A_CH0_ERR	BIT	0.E	High Speed Counter Module: Channel 0 error flag
Input	XGF-HD2A_RDY	BIT	0.F	High Speed Counter Module: Module ready
Input	XGF-HD2A_CH1_DN	BIT	1.0	High Speed Counter Module: CH1 up/down counter status flag
Input	XGF-HD2A_CH1_EXTPRE	BIT	1.1	High Speed Counter Module: Channel 1 external preset command detection flag
Input	XGF-HD2A_CH1_CRY	BIT	1.3	High Speed Counter Module: Channel 1 carry value
Input	XGF-HD2A_CH1_BRW	BIT	1.4	High Speed Counter Module: Channel 1 borrow value
Input	XGF-HD2A_CH1_AUXING	BIT	1.5	High Speed Counter Module: Channel 1 auxiliary function status
Input	XGF-HD2A_CH1_CMPOUT0	BIT	1.6	High Speed Counter Module: Channel 1 compare output 0 status
Input	XGF-HD2A_CH1_CMPOUT1	BIT	1.7	High Speed Counter Module: Channel 1 compare output 1 status
Input	XGF-HD2A_CH1_ERR	BIT	1.E	High Speed Counter Module: Channel 1 error flag
Input	XGF-HD2A_CH0_CNT_LV	Word	2	High Speed Counter Module: Channel 0 count value (LWORD)
Input	XGF-HD2A_CH0_CNT_HV	Word	3	High Speed Counter Module: Channel 0 count value (HWORD)
Input	XGF-HD2A_CH0_LTH_LV	Word	4	High Speed Counter Module: Channel 0 latch count value (LWORD)
Input	XGF-HD2A_CH0_LTH_HV	Word	5	High Speed Counter Module: Channel 0 latch count value (HWORD)
Input	XGF-HD2A_CH0_RNG_LV	Word	6	High Speed Counter Module: Channel 0 sampling count value (LWORD)
Input	XGF-HD2A_CH0_RNG_HV	Word	7	High Speed Counter Module: Channel 0 sampling count value (HWORD)
Input	XGF-HD2A_CH0_FRQ_LV	Word	8	High Speed Counter Module: Channel 0 input frequency value (LWORD)
Input	XGF-HD2A_CH0_FRQ_HV	Word	9	High Speed Counter Module: Channel 0 input frequency value (HWORD)
Input	XGF-HD2A_CH0_RPU_LV	Word	10	High Speed Counter Module: Channel 0 Rev./unit time value (LWORD)
Input	XGF-HD2A_CH0_RPU_HV	Word	11	High Speed Counter Module: Channel 0 Rev./unit time value (HWORD)
Input	XGF-HD2A_CH1_CNT_LV	Word	12	High Speed Counter Module: Channel 1 count value (LWORD)
Input	XGF-HD2A_CH1_CNT_HV	Word	13	High Speed Counter Module: Channel 1 count value (HWORD)
Input	XGF-HD2A_CH1_LTH_LV	Word	14	High Speed Counter Module: Channel 1 latch count value (LWORD)
Input	XGF-HD2A_CH1_LTH_HV	Word	15	High Speed Counter Module: Channel 1 latch count value (HWORD)
Input	XGF-HD2A_CH1_RNG_LV	Word	16	High Speed Counter Module: Channel 1 sampling count value (LWORD)
Input	XGF-HD2A_CH1_RNG_HV	Word	17	High Speed Counter Module: Channel 1 sampling count value (HWORD)
Input	XGF-HD2A_CH1_FRQ_LV	Word	18	High Speed Counter Module: Channel 1 input frequency value (LWORD)

Input	XGF-HD2A_CH1_FRQ_HV	Word	19	High Speed Counter Module: Channel 1 input frequency value (HWORD)
Input	XGF-HD2A_CH1_RPU_LV	Word	20	High Speed Counter Module: Channel 1 Rev./unit time value (LWORD)
Input	XGF-HD2A_CH1_RPU_HV	Word	21	High Speed Counter Module: Channel 1 Rev./unit time value (HWORD)
Input		WORD	22	Reserved

<Output>

Input/Output	Variable	Type	Word(16BIT) Offset	Comment
Output	XGF-HD2A_CH0_CNTEN	BIT	0.0	High Speed Counter Module: Channel 0 enable counter command(level)
Output	XGF-HD2A_CH0_PREEN	BIT	0.1	High Speed Counter Module: Channel 0 enable preset command(Edge)
Output	XGF-HD2A_CH0_DWNCNT	BIT	0.2	High Speed Counter Module: Channel 0 up/down counter select command(Level)
Output	XGF-HD2A_CH0_AUXEN	BIT	0.3	High Speed Counter Module: Channel 0 auxiliary function request(Edge,Level)
Output	XGF-HD2A_CH0_CMPEN	BIT	0.4	High Speed Counter Module: Channel 0 compare function enable command(Level)
Output	XGF-HD2A_CH0_OUTEN	BIT	0.5	High Speed Counter Module: Channel 0 compare output signal enable command(Level)
Output	XGF-HD2A_CH0_EQ0RST	BIT	0.6	High Speed Counter Module: Channel 0 compare output 0 equal reset command (Edge)
Output	XGF-HD2A_CH0_EQ1RST	BIT	0.7	High Speed Counter Module: Channel 0 compare output 1 equal reset command (Edge)
Output	XGF-HD2A_CH0_CRYBRW_RST	BIT	0.A	High Speed Counter Module: Channel 0 carry/borrow reset command(Edge)
Output	XGF-HD2A_CH0_EXTPST_EN	BIT	0.B	High Speed Counter Module: Channel 0 preset Ext. Input enable command
Output	XGF-HD2A_CH0_EXTAUX_EN	BIT	0.C	High Speed Counter Module: Channel 0 auxiliary function Ext. input enable command
Output	XGF-HD2A_CH0_EXTPST_RST	BIT	0.D	High Speed Counter Module: Channel 0 Ext. Input preset reset command
Output	XGF-HD2A_CH1_CNTEN	BIT	1.0	High Speed Counter Module: Channel 1 enable counter command(level)
Output	XGF-HD2A_CH1_PREEN	BIT	1.1	High Speed Counter Module: Channel 1 enable preset command(Edge)
Output	XGF-HD2A_CH1_DWNCNT	BIT	1.2	High Speed Counter Module: Channel 1 up/down counter select command(Level)
Output	XGF-HD2A_CH1_AUXEN	BIT	1.3	High Speed Counter Module: Channel 1 auxiliary function enable command(Edge,Level)
Output	XGF-HD2A_CH1_CMPEN	BIT	1.4	High Speed Counter Module: Channel 1 compare function enable command(Level)
Output	XGF-HD2A_CH1_OUTEN	BIT	1.5	High Speed Counter Module: Channel 1 compare output signal enable command(Level)
Output	XGF-HD2A_CH1_EQ0RST	BIT	1.6	High Speed Counter Module: Channel 0 compare output 0

Appendix

				equal reset command (Edge)
Output	XGF-HD2A_CH1_EQ1RST	BIT	1.7	High Speed Counter Module: Channel 1 compare output 0 equal reset command (Edge)
Output	XGF-HD2A_CH1_CRYBRW_RST	BIT	1.A	High Speed Counter Module: Channel 1 carry/borrow reset command(Edge)
Output	XGF-HD2A_CH1_EXTPST_EN	BIT	1.B	High Speed Counter Module: Channel 1 preset Ext. Input enable command
Output	XGF-HD2A_CH1_EXTAUX_EN	BIT	1.C	High Speed Counter Module: Channel 1 auxiliary Ext. Input enable command
Output	XGF-HD2A_CH1_EXTPST_RST	BIT	1.D	High Speed Counter Module: Channel 1 Ext. Input preset reset command

(18) XGF-HO8A

1) U Device

Input/Output	Variable	Type	Device	Comment
Input	XGF-HO8A_CH0_DN	BIT	Uxy.00.0	High Speed Counter Module: CH0 up/down counter status flag
Input	XGF-HO8A_CH0_AUXING	BIT	Uxy.00.1	High Speed Counter Module: Channel 0 auxiliary function status
Input	XGF-HO8A_CH0_CRY	BIT	Uxy.00.2	High Speed Counter Module: Channel 0 carry value
Input	XGF-HO8A_CH0_BRW	BIT	Uxy.00.3	High Speed Counter Module: Channel 0 borrow value
Input	XGF-HO8A_CH0_CMPOUT	BIT	Uxy.00.4	High Speed Counter Module: Channel 0 compare output status
Input	XGF-HO8A_CH0_ERR	BIT	Uxy.00.6	High Speed Counter Module: Channel 0 error flag
Input	XGF-HO8A_CH1_DN	BIT	Uxy.00.8	High Speed Counter Module: CH1 up/down counter status flag
Input	XGF-HO8A_CH1_AUXING	BIT	Uxy.00.9	High Speed Counter Module: Channel 1 auxiliary function status
Input	XGF-HO8A_CH1_CRY	BIT	Uxy.00.A	High Speed Counter Module: Channel 1 carry value
Input	XGF-HO8A_CH1_BRW	BIT	Uxy.00.B	High Speed Counter Module: Channel 1 borrow value
Input	XGF-HO8A_CH1_CMPOUT	BIT	Uxy.00.C	High Speed Counter Module: Channel 1 compare output status
Input	XGF-HO8A_CH1_ERR	BIT	Uxy.00.E	High Speed Counter Module: Channel 1 error flag
Input	XGF-HO8A_RDY	BIT	Uxy.00.F	High Speed Counter Module: Module ready
Input	XGF-HO8A_CH2_DN	BIT	Uxy.01.0	High Speed Counter Module: CH2 up/down counter status flag
Input	XGF-HO8A_CH2_AUXING	BIT	Uxy.01.1	High Speed Counter Module: Channel 2 auxiliary function status
Input	XGF-HO8A_CH2_CRY	BIT	Uxy.01.2	High Speed Counter Module: Channel 2 carry value

Input	XGF-HO8A_CH2_BRW	BIT	Uxy.01. 3	High Speed Counter Module: Channel 2 borrow value
Input	XGF-HO8A_CH2_CMPOUT	BIT	Uxy.01. 4	High Speed Counter Module: Channel 2 compare output status
Input	XGF-HO8A_CH2_ERR	BIT	Uxy.01. 6	High Speed Counter Module: Channel 2 error flag
Input	XGF-HO8A_CH3_DN	BIT	Uxy.01. 8	High Speed Counter Module: CH3 up/down counter status flag
Input	XGF-HO8A_CH3_AUXING	BIT	Uxy.01. 9	High Speed Counter Module: Channel 3 auxiliary function status
Input	XGF-HO8A_CH3_CRY	BIT	Uxy.01. A	High Speed Counter Module: Channel 3 carry value
Input	XGF-HO8A_CH3_BRW	BIT	Uxy.01. B	High Speed Counter Module: Channel 3 borrow value
Input	XGF-HO8A_CH3_CMPOUT	BIT	Uxy.01. C	High Speed Counter Module: Channel 3 compare output status
Input	XGF-HO8A_CH3_ERR	BIT	Uxy.01. E	High Speed Counter Module: Channel 3 error flag
Input	XGF-HO8A_CH4_DN	BIT	Uxy.02. 0	High Speed Counter Module: CH4 up/down counter status flag
Input	XGF-HO8A_CH4_AUXING	BIT	Uxy.02. 1	High Speed Counter Module: Channel 4 auxiliary function status
Input	XGF-HO8A_CH4_CRY	BIT	Uxy.02. 2	High Speed Counter Module: Channel 4 carry value
Input	XGF-HO8A_CH4_BRW	BIT	Uxy.02. 3	High Speed Counter Module: Channel 4 borrow value
Input	XGF-HO8A_CH4_CMPOUT	BIT	Uxy.02. 4	High Speed Counter Module: Channel 4 compare output status
Input	XGF-HO8A_CH4_ERR	BIT	Uxy.02. 6	High Speed Counter Module: Channel 4 error flag
Input	XGF-HO8A_CH5_DN	BIT	Uxy.02. 8	High Speed Counter Module: CH5 up/down counter status flag
Input	XGF-HO8A_CH5_AUXING	BIT	Uxy.02. 9	High Speed Counter Module: Channel 5 auxiliary function status
Input	XGF-HO8A_CH5_CRY	BIT	Uxy.02. A	High Speed Counter Module: Channel 5 carry value
Input	XGF-HO8A_CH5_BRW	BIT	Uxy.02. B	High Speed Counter Module: Channel 5 borrow value
Input	XGF-HO8A_CH5_CMPOUT	BIT	Uxy.02. C	High Speed Counter Module: Channel 5 compare output status
Input	XGF-HO8A_CH5_ERR	BIT	Uxy.02. E	High Speed Counter Module: Channel 5 error flag
Input	XGF-HO8A_CH6_DN	BIT	Uxy.03. 0	High Speed Counter Module: CH6 up/down counter status flag
Input	XGF-HO8A_CH6_AUXING	BIT	Uxy.03. 1	High Speed Counter Module: Channel 6 auxiliary function status
Input	XGF-HO8A_CH6_CRY	BIT	Uxy.03. 2	High Speed Counter Module: Channel 6 carry value
Input	XGF-HO8A_CH6_BRW	BIT	Uxy.03.	High Speed Counter Module: Channel 6 borrow value

Appendix

			3	
Input	XGF-HO8A_CH6_CMPOUT	BIT	Uxy.03. 4	High Speed Counter Module: Channel 6 compare output status
Input	XGF-HO8A_CH6_ERR	BIT	Uxy.03. 6	High Speed Counter Module: Channel 6 error flag
Input	XGF-HO8A_CH7_DN	BIT	Uxy.03. 8	High Speed Counter Module: CH7 up/down counter status flag
Input	XGF-HO8A_CH7_AUXING	BIT	Uxy.03. 9	High Speed Counter Module: Channel 7 auxiliary function status
Input	XGF-HO8A_CH7_CRY	BIT	Uxy.03. A	High Speed Counter Module: Channel 7 carry value
Input	XGF-HO8A_CH7_BRW	BIT	Uxy.03. B	High Speed Counter Module: Channel 7 borrow value
Input	XGF-HO8A_CH7_CMPOUT	BIT	Uxy.03. C	High Speed Counter Module: Channel 7 compare output status
Input	XGF-HO8A_CH7_ERR	BIT	Uxy.03. E	High Speed Counter Module: Channel 7 error flag
Output	XGF-HO8A_CH0_CNTEN	BIT	Uxy.21. 0	High Speed Counter Module: Channel 0 enable counter command(level)
Output	XGF-HO8A_CH0_DWNCNT	BIT	Uxy.21. 1	High Speed Counter Module: Channel 0 up/down counter select command(Level)
Output	XGF-HO8A_CH0_PREEN	BIT	Uxy.21. 2	High Speed Counter Module: Channel 0 enable preset command(Edge)
Output	XGF-HO8A_CH0_AUXEN	BIT	Uxy.21. 3	High Speed Counter Module: Channel 0 auxiliary function enable command(Edge,Level)
Output	XGF-HO8A_CH0_CRYBRW_RST	BIT	Uxy.21. 4	High Speed Counter Module: Channel 0 carry/borrow reset command(Edge)
Output	XGF-HO8A_CH0_CMPEN	BIT	Uxy.21. 5	High Speed Counter Module: Channel 0 compare function enable command(Level)
Output	XGF-HO8A_CH0_OUTEN	BIT	Uxy.21. 6	High Speed Counter Module: Channel 0 compare output signal enable command(Level)
Output	XGF-HO8A_CH0_EQRST	BIT	Uxy.21. 7	High Speed Counter Module: Channel 0 compare output 0 equal reset command (Edge)
Output	XGF-HO8A_CH1_CNTEN	BIT	Uxy.21. 8	High Speed Counter Module: Channel 1 enable counter command(level)
Output	XGF-HO8A_CH1_DWNCNT	BIT	Uxy.21. 9	High Speed Counter Module: Channel 1 up/down counter select command(Level)
Output	XGF-HO8A_CH1_PREEN	BIT	Uxy.21. A	High Speed Counter Module: Channel 1 enable preset command(Edge)
Output	XGF-HO8A_CH1_AUXEN	BIT	Uxy.21. B	High Speed Counter Module: Channel 1 auxiliary function enable command(Edge,Level)
Output	XGF-HO8A_CH1_CRYBRW_RST	BIT	Uxy.21. C	High Speed Counter Module: Channel 1 carry/borrow reset command(Edge)
Output	XGF-HO8A_CH1_CMPEN	BIT	Uxy.21. D	High Speed Counter Module: Channel 1 compare function enable command(Level)
Output	XGF-HO8A_CH1_OUTEN	BIT	Uxy.21. E	High Speed Counter Module: Channel 1 compare output signal enable command(Level)
Output	XGF-HO8A_CH1_EQRST	BIT	Uxy.21. F	High Speed Counter Module: Channel 1 compare output 0 equal reset command (Edge)

Output	XGF-HO8A_CH2_CNTEN	BIT	Uxy.22. 0	High Speed Counter Module: Channel 2 enable counter command(level)
Output	XGF-HO8A_CH2_DWNCNT	BIT	Uxy.22. 1	High Speed Counter Module: Channel 2 up/down counter select command(Level)
Output	XGF-HO8A_CH2_PREEN	BIT	Uxy.22. 2	High Speed Counter Module: Channel 2 enable preset command(Edge)
Output	XGF-HO8A_CH2_AUXEN	BIT	Uxy.22. 3	High Speed Counter Module: Channel 2 auxiliary function enable command(Edge,Level)
Output	XGF-HO8A_CH2_CRYBRW_RST	BIT	Uxy.22. 4	High Speed Counter Module: Channel 2 carry/borrow reset command(Edge)
Output	XGF-HO8A_CH2_CMPEN	BIT	Uxy.22. 5	High Speed Counter Module: Channel 2 compare function enable command(Level)
Output	XGF-HO8A_CH2_OUTEN	BIT	Uxy.22. 6	High Speed Counter Module: Channel 2 compare output signal enable command(Level)
Output	XGF-HO8A_CH2_EQRST	BIT	Uxy.22. 7	High Speed Counter Module: Channel 2 compare output 0 equal reset command (Edge)
Output	XGF-HO8A_CH3_CNTEN	BIT	Uxy.22. 8	High Speed Counter Module: Channel 3 enable counter command(level)
Output	XGF-HO8A_CH3_DWNCNT	BIT	Uxy.22. 9	High Speed Counter Module: Channel 3 up/down counter select command(Level)
Output	XGF-HO8A_CH3_PREEN	BIT	Uxy.22. A	High Speed Counter Module: Channel 3 enable preset command(Edge)
Output	XGF-HO8A_CH3_AUXEN	BIT	Uxy.22. B	High Speed Counter Module: Channel 3 auxiliary function enable command(Edge,Level)
Output	XGF-HO8A_CH3_CRYBRW_RST	BIT	Uxy.22. C	High Speed Counter Module: Channel 3 carry/borrow reset command(Edge)
Output	XGF-HO8A_CH3_CMPEN	BIT	Uxy.22. D	High Speed Counter Module: Channel 3 compare function enable command(Level)
Output	XGF-HO8A_CH3_OUTEN	BIT	Uxy.22. E	High Speed Counter Module: Channel 3 compare output signal enable command(Level)
Output	XGF-HO8A_CH3_EQRST	BIT	Uxy.22. F	High Speed Counter Module: Channel 3 compare output 0 equal reset command (Edge)
Output	XGF-HO8A_CH4_CNTEN	BIT	Uxy.23. 0	High Speed Counter Module: Channel 4 enable counter command(level)
Output	XGF-HO8A_CH4_DWNCNT	BIT	Uxy.23. 1	High Speed Counter Module: Channel 4 up/down counter select command(Level)
Output	XGF-HO8A_CH4_PREEN	BIT	Uxy.23. 2	High Speed Counter Module: Channel 4 enable preset command(Edge)
Output	XGF-HO8A_CH4_AUXEN	BIT	Uxy.23. 3	High Speed Counter Module: Channel 4 auxiliary function enable command(Edge,Level)
Output	XGF-HO8A_CH4_CRYBRW_RST	BIT	Uxy.23. 4	High Speed Counter Module: Channel 4 carry/borrow reset command(Edge)
Output	XGF-HO8A_CH4_CMPEN	BIT	Uxy.23. 5	High Speed Counter Module: Channel 4 compare function enable command(Level)
Output	XGF-HO8A_CH4_OUTEN	BIT	Uxy.23. 6	High Speed Counter Module: Channel 4 compare output signal enable command(Level)
Output	XGF-HO8A_CH4_EQRST	BIT	Uxy.23. 7	High Speed Counter Module: Channel 4 compare output 0 equal reset command (Edge)
Output	XGF-HO8A_CH5_CNTEN	BIT	Uxy.23.	High Speed Counter Module: Channel 5 enable counter command(level)

Appendix

			8	
Output	XGF-HO8A_CH5_DWNCNT	BIT	Uxy.23. 9	High Speed Counter Module: Channel 5 up/down counter select command(Level)
Output	XGF-HO8A_CH5_PREEN	BIT	Uxy.23. A	High Speed Counter Module: Channel 5 enable preset command(Edge)
Output	XGF-HO8A_CH5_AUXEN	BIT	Uxy.23. B	High Speed Counter Module: Channel 5 auxiliary function enable command(Edge,Level)
Output	XGF-HO8A_CH5_CRYBRW_RST	BIT	Uxy.23. C	High Speed Counter Module: Channel 5 carry/borrow reset command(Edge)
Output	XGF-HO8A_CH5_CMPEN	BIT	Uxy.23. D	High Speed Counter Module: Channel 5 compare function enable command(Level)
Output	XGF-HO8A_CH5_OUTEN	BIT	Uxy.23. E	High Speed Counter Module: Channel 5 compare output signal enable command(Level)
Output	XGF-HO8A_CH5_EQRST	BIT	Uxy.23. F	High Speed Counter Module: Channel 5 compare output 0 equal reset command (Edge)
Output	XGF-HO8A_CH6_CNTEN	BIT	Uxy.24. 0	High Speed Counter Module: Channel 6 enable counter command(level)
Output	XGF-HO8A_CH6_DWNCNT	BIT	Uxy.24. 1	High Speed Counter Module: Channel 6 up/down counter select command(Level)
Output	XGF-HO8A_CH6_PREEN	BIT	Uxy.24. 2	High Speed Counter Module: Channel 6 enable preset command(Edge)
Output	XGF-HO8A_CH6_AUXEN	BIT	Uxy.24. 3	High Speed Counter Module: Channel 6 auxiliary function enable command(Edge,Level)
Output	XGF-HO8A_CH6_CRYBRW_RST	BIT	Uxy.24. 4	High Speed Counter Module: Channel 6 carry/borrow reset command(Edge)
Output	XGF-HO8A_CH6_CMPEN	BIT	Uxy.24. 5	High Speed Counter Module: Channel 6 compare function enable command(Level)
Output	XGF-HO8A_CH6_OUTEN	BIT	Uxy.24. 6	High Speed Counter Module: Channel 6 compare output signal enable command(Level)
Output	XGF-HO8A_CH6_EQRST	BIT	Uxy.24. 7	High Speed Counter Module: Channel 6 compare output 0 equal reset command (Edge)
Output	XGF-HO8A_CH7_CNTEN	BIT	Uxy.24. 8	High Speed Counter Module: Channel 7 enable counter command(level)
Output	XGF-HO8A_CH7_DWNCNT	BIT	Uxy.24. 9	High Speed Counter Module: Channel 7 up/down counter select command(Level)
Output	XGF-HO8A_CH7_PREEN	BIT	Uxy.24. A	High Speed Counter Module: Channel 7 enable preset command(Edge)
Output	XGF-HO8A_CH7_AUXEN	BIT	Uxy.24. B	High Speed Counter Module: Channel 7 auxiliary function enable command(Edge,Level)
Output	XGF-HO8A_CH7_CRYBRW_RST	BIT	Uxy.24. C	High Speed Counter Module: Channel 7 carry/borrow reset command(Edge)
Output	XGF-HO8A_CH7_CMPEN	BIT	Uxy.24. D	High Speed Counter Module: Channel 7 compare function enable command(Level)
Output	XGF-HO8A_CH7_OUTEN	BIT	Uxy.24. E	High Speed Counter Module: Channel 7 compare output signal enable command(Level)
Output	XGF-HO8A_CH7_EQRST	BIT	Uxy.24. F	High Speed Counter Module: Channel 7 compare output 0 equal reset command (Edge)
Input	XGF-HO8A_CH0_CNT_LV	Word	Uxy.04	High Speed Counter Module: Channel 0 count value (LWORD)

Input	XGF-HO8A_CH0_CNT_HV	Word	Uxy.05	High Speed Counter Module: Channel 0 count value (HWORD)
Input	XGF-HO8A_CH1_CNT_LV	Word	Uxy.06	High Speed Counter Module: Channel 1 count value (LWORD)
Input	XGF-HO8A_CH1_CNT_HV	Word	Uxy.07	High Speed Counter Module: Channel 1 count value (HWORD)
Input	XGF-HO8A_CH2_CNT_LV	Word	Uxy.08	High Speed Counter Module: Channel 2 count value (LWORD)
Input	XGF-HO8A_CH2_CNT_HV	Word	Uxy.09	High Speed Counter Module: Channel 2 count value (HWORD)
Input	XGF-HO8A_CH3_CNT_LV	Word	Uxy.10	High Speed Counter Module: Channel 3 count value (LWORD)
Input	XGF-HO8A_CH3_CNT_HV	Word	Uxy.11	High Speed Counter Module: Channel 3 count value (HWORD)
Input	XGF-HO8A_CH4_CNT_LV	Word	Uxy.12	High Speed Counter Module: Channel 4 count value (LWORD)
Input	XGF-HO8A_CH4_CNT_HV	Word	Uxy.13	High Speed Counter Module: Channel 4 count value (HWORD)
Input	XGF-HO8A_CH5_CNT_LV	Word	Uxy.14	High Speed Counter Module: Channel 5 count value (LWORD)
Input	XGF-HO8A_CH5_CNT_HV	Word	Uxy.15	High Speed Counter Module: Channel 5 count value (HWORD)
Input	XGF-HO8A_CH6_CNT_LV	Word	Uxy.16	High Speed Counter Module: Channel 6 count value (LWORD)
Input	XGF-HO8A_CH6_CNT_HV	Word	Uxy.17	High Speed Counter Module: Channel 6 count value (HWORD)
Input	XGF-HO8A_CH7_CNT_LV	Word	Uxy.18	High Speed Counter Module: Channel 7 count value (LWORD)
Input	XGF-HO8A_CH7_CNT_HV	Word	Uxy.19	High Speed Counter Module: Channel 7 count value (HWORD)

2) Refresh data

<Input>

Input/Output	Variable	Type	Word(16BIT) Offset	Comment
Input	XGF-HO8A_CH0_DN	BIT	0.0	High Speed Counter Module: CH0 up/down counter status flag
Input	XGF-HO8A_CH0_AUXING	BIT	0.1	High Speed Counter Module: Channel 0 auxiliary function status
Input	XGF-HO8A_CH0_CRY	BIT	0.2	High Speed Counter Module: Channel 0 carry value
Input	XGF-HO8A_CH0_BRW	BIT	0.3	High Speed Counter Module: Channel 0 borrow value
Input	XGF-HO8A_CH0_CMPOUT	BIT	0.4	High Speed Counter Module: Channel 0 compare output status
Input	XGF-HO8A_CH0_ERR	BIT	0.6	High Speed Counter Module: Channel 0 error flag
Input	XGF-HO8A_CH1_DN	BIT	0.8	High Speed Counter Module: CH1 up/down counter status flag
Input	XGF-HO8A_CH1_AUXING	BIT	0.9	High Speed Counter Module: Channel 1 auxiliary function status
Input	XGF-HO8A_CH1_CRY	BIT	0.A	High Speed Counter Module: Channel 1 carry value
Input	XGF-HO8A_CH1_BRW	BIT	0.B	High Speed Counter Module: Channel 1 borrow value

Appendix

Input	XGF-HO8A_CH1_CMPOUT	BIT	0.C	High Speed Counter Module: Channel 1 compare output status
Input	XGF-HO8A_CH1_ERR	BIT	0.E	High Speed Counter Module: Channel 1 error flag
Input	XGF-HO8A_RDY	BIT	0.F	High Speed Counter Module: Module ready
Input	XGF-HO8A_CH2_DN	BIT	1.0	High Speed Counter Module: CH2 up/down counter status flag
Input	XGF-HO8A_CH2_AUXING	BIT	1.1	High Speed Counter Module: Channel 2 auxiliary function status
Input	XGF-HO8A_CH2_CRY	BIT	1.2	High Speed Counter Module: Channel 2 carry value
Input	XGF-HO8A_CH2_BRW	BIT	1.3	High Speed Counter Module: Channel 2 borrow value
Input	XGF-HO8A_CH2_CMPOUT	BIT	1.4	High Speed Counter Module: Channel 2 compare output status
Input	XGF-HO8A_CH2_ERR	BIT	1.6	High Speed Counter Module: Channel 2 error flag
Input	XGF-HO8A_CH3_DN	BIT	1.8	High Speed Counter Module: CH3 up/down counter status flag
Input	XGF-HO8A_CH3_AUXING	BIT	1.9	High Speed Counter Module: Channel 3 auxiliary function status
Input	XGF-HO8A_CH3_CRY	BIT	1.A	High Speed Counter Module: Channel 3 carry value
Input	XGF-HO8A_CH3_BRW	BIT	1.B	High Speed Counter Module: Channel 3 borrow value
Input	XGF-HO8A_CH3_CMPOUT	BIT	1.C	High Speed Counter Module: Channel 3 compare output status
Input	XGF-HO8A_CH3_ERR	BIT	1.E	High Speed Counter Module: Channel 3 error flag
Input	XGF-HO8A_CH4_DN	BIT	2.0	High Speed Counter Module: CH4 up/down counter status flag
Input	XGF-HO8A_CH4_AUXING	BIT	2.1	High Speed Counter Module: Channel 4 auxiliary function status
Input	XGF-HO8A_CH4_CRY	BIT	2.2	High Speed Counter Module: Channel 4 carry value
Input	XGF-HO8A_CH4_BRW	BIT	2.3	High Speed Counter Module: Channel 4 borrow value
Input	XGF-HO8A_CH4_CMPOUT	BIT	2.4	High Speed Counter Module: Channel 4 compare output status
Input	XGF-HO8A_CH4_ERR	BIT	2.6	High Speed Counter Module: Channel 4 error flag
Input	XGF-HO8A_CH5_DN	BIT	2.8	High Speed Counter Module: CH5 up/down counter status flag
Input	XGF-HO8A_CH5_AUXING	BIT	2.9	High Speed Counter Module: Channel 5 auxiliary function status
Input	XGF-HO8A_CH5_CRY	BIT	2.A	High Speed Counter Module: Channel 5 carry value
Input	XGF-HO8A_CH5_BRW	BIT	2.B	High Speed Counter Module: Channel 5 borrow value
Input	XGF-HO8A_CH5_CMPOUT	BIT	2.C	High Speed Counter Module: Channel 5 compare output status
Input	XGF-HO8A_CH5_ERR	BIT	2.E	High Speed Counter Module: Channel 5 error flag
Input	XGF-HO8A_CH6_DN	BIT	3.0	High Speed Counter Module: CH6 up/down counter status flag
Input	XGF-HO8A_CH6_AUXING	BIT	3.1	High Speed Counter Module: Channel 6 auxiliary function status
Input	XGF-HO8A_CH6_CRY	BIT	3.2	High Speed Counter Module: Channel 6 carry value
Input	XGF-HO8A_CH6_BRW	BIT	3.3	High Speed Counter Module: Channel 6 borrow value
Input	XGF-HO8A_CH6_CMPOUT	BIT	3.4	High Speed Counter Module: Channel 6 compare output status
Input	XGF-HO8A_CH6_ERR	BIT	3.6	High Speed Counter Module: Channel 6 error flag
Input	XGF-HO8A_CH7_DN	BIT	3.8	High Speed Counter Module: CH7 up/down counter status flag
Input	XGF-HO8A_CH7_AUXING	BIT	3.9	High Speed Counter Module: Channel 7 auxiliary function status
Input	XGF-HO8A_CH7_CRY	BIT	3.A	High Speed Counter Module: Channel 7 carry value
Input	XGF-HO8A_CH7_BRW	BIT	3.B	High Speed Counter Module: Channel 7 borrow value

Input	XGF-HO8A_CH7_CMPOUT	BIT	3.C	High Speed Counter Module: Channel 7 compare output status
Input	XGF-HO8A_CH7_ERR	BIT	3.E	High Speed Counter Module: Channel 7 error flag
Input	XGF-HO8A_CH0_CNT_LV	Word	4	High Speed Counter Module: Channel 0 count value (LWORD)
Input	XGF-HO8A_CH0_CNT_HV	Word	5	High Speed Counter Module: Channel 0 count value (HWORD)
Input	XGF-HO8A_CH1_CNT_LV	Word	6	High Speed Counter Module: Channel 1 count value (LWORD)
Input	XGF-HO8A_CH1_CNT_HV	Word	7	High Speed Counter Module: Channel 1 count value (HWORD)
Input	XGF-HO8A_CH2_CNT_LV	Word	8	High Speed Counter Module: Channel 2 count value (LWORD)
Input	XGF-HO8A_CH2_CNT_HV	Word	9	High Speed Counter Module: Channel 2 count value (HWORD)
Input	XGF-HO8A_CH3_CNT_LV	Word	10	High Speed Counter Module: Channel 3 count value (LWORD)
Input	XGF-HO8A_CH3_CNT_HV	Word	11	High Speed Counter Module: Channel 3 count value (HWORD)
Input	XGF-HO8A_CH4_CNT_LV	Word	12	High Speed Counter Module: Channel 4 count value (LWORD)
Input	XGF-HO8A_CH4_CNT_HV	Word	13	High Speed Counter Module: Channel 4 count value (HWORD)
Input	XGF-HO8A_CH5_CNT_LV	Word	14	High Speed Counter Module: Channel 5 count value (LWORD)
Input	XGF-HO8A_CH5_CNT_HV	Word	15	High Speed Counter Module: Channel 5 count value (HWORD)
Input	XGF-HO8A_CH6_CNT_LV	Word	16	High Speed Counter Module: Channel 6 count value (LWORD)
Input	XGF-HO8A_CH6_CNT_HV	Word	17	High Speed Counter Module: Channel 6 count value (HWORD)
Input	XGF-HO8A_CH7_CNT_LV	Word	18	High Speed Counter Module: Channel 7 count value (LWORD)
Input	XGF-HO8A_CH7_CNT_HV	Word	19	High Speed Counter Module: Channel 7 count value (HWORD)
Input		WORD	20	Reserved

<Output>

Input/Output	Variable	Type	Word(16BIT) Offset	Comment
Output	XGF-HO8A_CH0_CNTEN	BIT	0.0	High Speed Counter Module: Channel 0 enable counter command(level)
Output	XGF-HO8A_CH0_DWNCNT	BIT	0.1	High Speed Counter Module: Channel 0 up/down counter select command(Level)
Output	XGF-HO8A_CH0_PREEN	BIT	0.2	High Speed Counter Module: Channel 0 enable preset command(Edge)
Output	XGF-HO8A_CH0_AUXEN	BIT	0.3	High Speed Counter Module: Channel 0 auxiliary function enable command(Edge,Level)
Output	XGF-HO8A_CH0_CRYBRW_RST	BIT	0.4	High Speed Counter Module: Channel 0 carry/borrow reset command(Edge)
Output	XGF-HO8A_CH0_CMPEN	BIT	0.5	High Speed Counter Module: Channel 0 compare function enable command(Level)
Output	XGF-HO8A_CH0_OUTEN	BIT	0.6	High Speed Counter Module: Channel 0 compare output signal enable command(Level)
Output	XGF-HO8A_CH0_EQRST	BIT	0.7	High Speed Counter Module: Channel 0 compare output 0 equal reset command (Edge)
Output	XGF-HO8A_CH1_CNTEN	BIT	0.8	High Speed Counter Module: Channel 1 enable counter command(level)
Output	XGF-HO8A_CH1_DWNCNT	BIT	0.9	High Speed Counter Module: Channel 1 up/down counter select command(Level)
Output	XGF-HO8A_CH1_PREEN	BIT	0.A	High Speed Counter Module: Channel 1 enable preset command(Edge)
Output	XGF-HO8A_CH1_AUXEN	BIT	0.B	High Speed Counter Module: Channel 1 auxiliary function enable command(Edge,Level)

Appendix

Output	XGF-HO8A_CH1_CRYBRW_RST	BIT	0.C	High Speed Counter Module: Channel 1 carry/borrow reset command(Edge)
Output	XGF-HO8A_CH1_CMPEN	BIT	0.D	High Speed Counter Module: Channel 1 compare function enable command(Level)
Output	XGF-HO8A_CH1_OUTEN	BIT	0.E	High Speed Counter Module: Channel 1 compare output signal enable command(Level)
Output	XGF-HO8A_CH1_EQRST	BIT	0.F	High Speed Counter Module: Channel 1 compare output 0 equal reset command (Edge)
Output	XGF-HO8A_CH2_CNTEN	BIT	1.0	High Speed Counter Module: Channel 2 enable counter command(level)
Output	XGF-HO8A_CH2_DWNCNT	BIT	1.1	High Speed Counter Module: Channel 2 up/down counter select command(Level)
Output	XGF-HO8A_CH2_PREEN	BIT	1.2	High Speed Counter Module: Channel 2 enable preset command(Edge)
Output	XGF-HO8A_CH2_AUXEN	BIT	1.3	High Speed Counter Module: Channel 2 auxiliary function enable command(Edge,Level)
Output	XGF-HO8A_CH2_CRYBRW_RST	BIT	1.4	High Speed Counter Module: Channel 2 carry/borrow reset command(Edge)
Output	XGF-HO8A_CH2_CMPEN	BIT	1.5	High Speed Counter Module: Channel 2 compare function enable command(Level)
Output	XGF-HO8A_CH2_OUTEN	BIT	1.6	High Speed Counter Module: Channel 2 compare output signal enable command(Level)
Output	XGF-HO8A_CH2_EQRST	BIT	1.7	High Speed Counter Module: Channel 2 compare output 0 equal reset command (Edge)
Output	XGF-HO8A_CH3_CNTEN	BIT	1.8	High Speed Counter Module: Channel 3 enable counter command(level)
Output	XGF-HO8A_CH3_DWNCNT	BIT	1.9	High Speed Counter Module: Channel 3 up/down counter select command(Level)
Output	XGF-HO8A_CH3_PREEN	BIT	1.A	High Speed Counter Module: Channel 3 enable preset command(Edge)
Output	XGF-HO8A_CH3_AUXEN	BIT	1.B	High Speed Counter Module: Channel 3 auxiliary function enable command(Edge,Level)
Output	XGF-HO8A_CH3_CRYBRW_RST	BIT	1.C	High Speed Counter Module: Channel 3 carry/borrow reset command(Edge)
Output	XGF-HO8A_CH3_CMPEN	BIT	1.D	High Speed Counter Module: Channel 3 compare function enable command(Level)
Output	XGF-HO8A_CH3_OUTEN	BIT	1.E	High Speed Counter Module: Channel 3 compare output signal enable command(Level)
Output	XGF-HO8A_CH3_EQRST	BIT	1.F	High Speed Counter Module: Channel 3 compare output 0 equal reset command (Edge)
Output	XGF-HO8A_CH4_CNTEN	BIT	2.0	High Speed Counter Module: Channel 4 enable counter command(level)
Output	XGF-HO8A_CH4_DWNCNT	BIT	2.1	High Speed Counter Module: Channel 4 up/down counter select command(Level)
Output	XGF-HO8A_CH4_PREEN	BIT	2.2	High Speed Counter Module: Channel 4 enable preset command(Edge)
Output	XGF-HO8A_CH4_AUXEN	BIT	2.3	High Speed Counter Module: Channel 4 auxiliary function enable command(Edge,Level)
Output	XGF-	BIT	2.4	High Speed Counter Module: Channel 4 carry/borrow reset

	HO8A_CH4_CRYBRW_RST			command(Edge)
Output	XGF-HO8A_CH4_CMPEN	BIT	2.5	High Speed Counter Module: Channel 4 compare function enable command(Level)
Output	XGF-HO8A_CH4_OUTEN	BIT	2.6	High Speed Counter Module: Channel 4 compare output signal enable command(Level)
Output	XGF-HO8A_CH4_EQRST	BIT	2.7	High Speed Counter Module: Channel 4 compare output 0 equal reset command (Edge)
Output	XGF-HO8A_CH5_CNTEN	BIT	2.8	High Speed Counter Module: Channel 5 enable counter command(level)
Output	XGF-HO8A_CH5_DWNCNT	BIT	2.9	High Speed Counter Module: Channel 5 up/down counter select command(Level)
Output	XGF-HO8A_CH5_PREEN	BIT	2.A	High Speed Counter Module: Channel 5 enable preset command(Edge)
Output	XGF-HO8A_CH5_AUXEN	BIT	2.B	High Speed Counter Module: Channel 5 auxiliary function enable command(Edge,Level)
Output	XGF-HO8A_CH5_CRYBRW_RST	BIT	2.C	High Speed Counter Module: Channel 5 carry/borrow reset command(Edge)
Output	XGF-HO8A_CH5_CMPEN	BIT	2.D	High Speed Counter Module: Channel 5 compare function enable command(Level)
Output	XGF-HO8A_CH5_OUTEN	BIT	2.E	High Speed Counter Module: Channel 5 compare output signal enable command(Level)
Output	XGF-HO8A_CH5_EQRST	BIT	2.F	High Speed Counter Module: Channel 5 compare output 0 equal reset command (Edge)
Output	XGF-HO8A_CH6_CNTEN	BIT	3.0	High Speed Counter Module: Channel 6 enable counter command(level)
Output	XGF-HO8A_CH6_DWNCNT	BIT	3.1	High Speed Counter Module: Channel 6 up/down counter select command(Level)
Output	XGF-HO8A_CH6_PREEN	BIT	3.2	High Speed Counter Module: Channel 6 enable preset command(Edge)
Output	XGF-HO8A_CH6_AUXEN	BIT	3.3	High Speed Counter Module: Channel 6 auxiliary function enable command(Edge,Level)
Output	XGF-HO8A_CH6_CRYBRW_RST	BIT	3.4	High Speed Counter Module: Channel 6 carry/borrow reset command(Edge)
Output	XGF-HO8A_CH6_CMPEN	BIT	3.5	High Speed Counter Module: Channel 6 compare function enable command(Level)
Output	XGF-HO8A_CH6_OUTEN	BIT	3.6	High Speed Counter Module: Channel 6 compare output signal enable command(Level)
Output	XGF-HO8A_CH6_EQRST	BIT	3.7	High Speed Counter Module: Channel 6 compare output 0 equal reset command (Edge)
Output	XGF-HO8A_CH7_CNTEN	BIT	3.8	High Speed Counter Module: Channel 7 enable counter command(level)
Output	XGF-HO8A_CH7_DWNCNT	BIT	3.9	High Speed Counter Module: Channel 7 up/down counter select command(Level)
Output	XGF-HO8A_CH7_PREEN	BIT	3.A	High Speed Counter Module: Channel 7 enable preset command(Edge)
Output	XGF-HO8A_CH7_AUXEN	BIT	3.B	High Speed Counter Module: Channel 7 auxiliary function enable command(Edge,Level)
Output	XGF-HO8A_CH7_CRYBRW_RST	BIT	3.C	High Speed Counter Module: Channel 7 carry/borrow reset command(Edge)

Appendix

Output	XGF-HO8A_CH7_CMPEN	BIT	3.D	High Speed Counter Module: Channel 7 compare function enable command(Level)
Output	XGF-HO8A_CH7_OUTEN	BIT	3.E	High Speed Counter Module: Channel 7 compare output signal enable command(Level)
Output	XGF-HO8A_CH7_EQRST	BIT	3.F	High Speed Counter Module: Channel 7 compare output 0 equal reset command (Edge)

(19) XGF-RD8A

1) U Device

Input/Output	Variable	Type	Device	Comment
Input	XGF-RD8A_CH0_ADJERR	BIT	Uxy.00.0	RTD Input Module: Channel 0 offset/Gain error flag
Input	XGF-RD8A_CH1_ADJERR	BIT	Uxy.00.1	RTD Input Module: Channel 1 offset/Gain error flag
Input	XGF-RD8A_CH2_ADJERR	BIT	Uxy.00.2	RTD Input Module: Channel 2 offset/Gain error flag
Input	XGF-RD8A_CH3_ADJERR	BIT	Uxy.00.3	RTD Input Module: Channel 3 offset/Gain error flag
Input	XGF-RD8A_CH4_ADJERR	BIT	Uxy.00.4	RTD Input Module: Channel 4 offset/Gain error flag
Input	XGF-RD8A_CH5_ADJERR	BIT	Uxy.00.5	RTD Input Module: Channel 5 offset/Gain error flag
Input	XGF-RD8A_CH6_ADJERR	BIT	Uxy.00.6	RTD Input Module: Channel 6 offset/Gain error flag
Input	XGF-RD8A_CH7_ADJERR	BIT	Uxy.00.7	RTD Input Module: Channel 7 offset/Gain error flag
Input	XGF-RD8A_EEPROMERR	BIT	Uxy.00.D	RTD Input Module: Offset/Gain backup error flag
Input	XGF-RD8A_WDT_ERR	BIT	Uxy.00.E	RTD Input Module: H/W Error Flag
Input	XGF-RD8A_RDY	BIT	Uxy.00.F	RTD Input Module: Module ready
Input	XGF-RD8A_CH0_ACT	BIT	Uxy.01.0	RTD Input Module: CH0 RUN
Input	XGF-RD8A_CH1_ACT	BIT	Uxy.01.1	RTD Input Module: CH1 RUN
Input	XGF-RD8A_CH2_ACT	BIT	Uxy.01.2	RTD Input Module: CH2 RUN
Input	XGF-RD8A_CH3_ACT	BIT	Uxy.01.3	RTD Input Module: CH3 RUN
Input	XGF-RD8A_CH4_ACT	BIT	Uxy.01.4	RTD Input Module: CH4 RUN
Input	XGF-RD8A_CH5_ACT	BIT	Uxy.01.5	RTD Input Module: CH5 RUN
Input	XGF-RD8A_CH6_ACT	BIT	Uxy.01.6	RTD Input Module: CH6 RUN
Input	XGF-RD8A_CH7_ACT	BIT	Uxy.01.7	RTD Input Module: CH7 RUN
Input	XGF-RD8A_CH0_BOUT	BIT	Uxy.01.8	RTD Input Module: Channel 0 disconnection flag
Input	XGF-RD8A_CH1_BOUT	BIT	Uxy.01.9	RTD Input Module: Channel 1 disconnection flag
Input	XGF-RD8A_CH2_BOUT	BIT	Uxy.01.A	RTD Input Module: Channel 2 disconnection flag
Input	XGF-RD8A_CH3_BOUT	BIT	Uxy.01.B	RTD Input Module: Channel 3 disconnection flag
Input	XGF-RD8A_CH4_BOUT	BIT	Uxy.01.C	RTD Input Module: Channel 4 disconnection flag
Input	XGF-RD8A_CH5_BOUT	BIT	Uxy.01.D	RTD Input Module: Channel 5 disconnection flag
Input	XGF-RD8A_CH6_BOUT	BIT	Uxy.01.E	RTD Input Module: Channel 6 disconnection flag
Input	XGF-RD8A_CH7_BOUT	BIT	Uxy.01.F	RTD Input Module: Channel 7 disconnection flag
Input	XGF-RD8A_CH0_SETERR	BIT	Uxy.02.0	RTD Input Module: Channel 0 error code
Input	XGF-RD8A_CH1_SETERR	BIT	Uxy.02.1	RTD Input Module: Channel 1 error code
Input	XGF-RD8A_CH2_SETERR	BIT	Uxy.02.2	RTD Input Module: Channel 2 error code
Input	XGF-RD8A_CH3_SETERR	BIT	Uxy.02.3	RTD Input Module: Channel 3 error code
Input	XGF-RD8A_CH4_SETERR	BIT	Uxy.02.4	RTD Input Module: Channel 4 error code
Input	XGF-RD8A_CH5_SETERR	BIT	Uxy.02.5	RTD Input Module: Channel 5 error code
Input	XGF-RD8A_CH6_SETERR	BIT	Uxy.02.6	RTD Input Module: Channel 6 error code
Input	XGF-RD8A_CH7_SETERR	BIT	Uxy.02.7	RTD Input Module: Channel 7 error code
Input	XGF-RD8A_CH0_PALL	BIT	Uxy.03.0	RTD Input Module: Channel 0 process alarm ultra lower limit flag
Input	XGF-RD8A_CH0_PAL	BIT	Uxy.03.1	RTD Input Module: Channel 0 process alarm lower limit flag

Input	XGF-RD8A_CH0_PAH	BIT	Uxy.03.2	RTD Input Module: Channel 0 process alarm upper limit flag
Input	XGF-RD8A_CH0_PAHH	BIT	Uxy.03.3	RTD Input Module: Channel 0 process alarm ultra upper limit flag
Input	XGF-RD8A_CH1_PALL	BIT	Uxy.03.4	RTD Input Module: Channel 1 process alarm ultra lower limit flag
Input	XGF-RD8A_CH1_PAL	BIT	Uxy.03.5	RTD Input Module: Channel 1 process alarm lower limit flag
Input	XGF-RD8A_CH1_PAH	BIT	Uxy.03.6	RTD Input Module: Channel 1 process alarm upper limit flag
Input	XGF-RD8A_CH1_PAHH	BIT	Uxy.03.7	RTD Input Module: Channel 1 process alarm ultra upper limit flag
Input	XGF-RD8A_CH2_PALL	BIT	Uxy.03.8	RTD Input Module: Channel 2 process alarm ultra lower limit flag
Input	XGF-RD8A_CH2_PAL	BIT	Uxy.03.9	RTD Input Module: Channel 2 process alarm lower limit flag
Input	XGF-RD8A_CH2_PAH	BIT	Uxy.03.A	RTD Input Module: Channel 2 process alarm upper limit flag
Input	XGF-RD8A_CH2_PAHH	BIT	Uxy.03.B	RTD Input Module: Channel 2 process alarm ultra upper limit flag
Input	XGF-RD8A_CH3_PALL	BIT	Uxy.03.C	RTD Input Module: Channel 3 process alarm ultra lower limit flag
Input	XGF-RD8A_CH3_PAL	BIT	Uxy.03.D	RTD Input Module: Channel 3 process alarm lower limit flag
Input	XGF-RD8A_CH3_PAH	BIT	Uxy.03.E	RTD Input Module: Channel 3 process alarm upper limit flag
Input	XGF-RD8A_CH3_PAHH	BIT	Uxy.03.F	RTD Input Module: Channel 3 process alarm ultra upper limit flag
Input	XGF-RD8A_CH4_PALL	BIT	Uxy.04.0	RTD Input Module: Channel 4 process alarm ultra lower limit flag
Input	XGF-RD8A_CH4_PAL	BIT	Uxy.04.1	RTD Input Module: Channel 4 process alarm lower limit flag
Input	XGF-RD8A_CH4_PAH	BIT	Uxy.04.2	RTD Input Module: Channel 4 process alarm upper limit flag
Input	XGF-RD8A_CH4_PAHH	BIT	Uxy.04.3	RTD Input Module: Channel 4 process alarm ultra upper limit flag
Input	XGF-RD8A_CH5_PALL	BIT	Uxy.04.4	RTD Input Module: Channel 5 process alarm ultra lower limit flag
Input	XGF-RD8A_CH5_PAL	BIT	Uxy.04.5	RTD Input Module: Channel 5 process alarm lower limit flag
Input	XGF-RD8A_CH5_PAH	BIT	Uxy.04.6	RTD Input Module: Channel 5 process alarm upper limit flag
Input	XGF-RD8A_CH5_PAHH	BIT	Uxy.04.7	RTD Input Module: Channel 5 process alarm ultra upper limit flag
Input	XGF-RD8A_CH6_PALL	BIT	Uxy.04.8	RTD Input Module: Channel 6 process alarm ultra lower limit flag
Input	XGF-RD8A_CH6_PAL	BIT	Uxy.04.9	RTD Input Module: Channel 6 process alarm lower limit flag
Input	XGF-RD8A_CH6_PAH	BIT	Uxy.04.A	RTD Input Module: Channel 6 process alarm upper limit flag
Input	XGF-RD8A_CH6_PAHH	BIT	Uxy.04.B	RTD Input Module: Channel 6 process alarm ultra upper limit flag
Input	XGF-RD8A_CH7_PALL	BIT	Uxy.04.C	RTD Input Module: Channel 7 process alarm ultra lower limit flag
Input	XGF-RD8A_CH7_PAL	BIT	Uxy.04.D	RTD Input Module: Channel 7 process alarm lower limit flag
Input	XGF-RD8A_CH7_PAH	BIT	Uxy.04.E	RTD Input Module: Channel 7 process alarm upper limit flag
Input	XGF-RD8A_CH7_PAHH	BIT	Uxy.04.F	RTD Input Module: Channel 7 process alarm ultra upper limit flag
Input	XGF-RD8A_CH0_RAL	BIT	Uxy.05.0	RTD Input Module: Channel 0 rate change alarm lower limit flag
Input	XGF-RD8A_CH0_RAH	BIT	Uxy.05.1	RTD Input Module: Channel 0 rate change alarm upper limit flag
Input	XGF-RD8A_CH1_RAL	BIT	Uxy.05.2	RTD Input Module: Channel 1 rate change alarm lower limit flag
Input	XGF-RD8A_CH1_RAH	BIT	Uxy.05.3	RTD Input Module: Channel 1 rate change alarm upper limit flag
Input	XGF-RD8A_CH2_RAL	BIT	Uxy.05.4	RTD Input Module: Channel 2 rate change alarm lower limit flag
Input	XGF-RD8A_CH2_RAH	BIT	Uxy.05.5	RTD Input Module: Channel 2 rate change alarm upper limit flag
Input	XGF-RD8A_CH3_RAL	BIT	Uxy.05.6	RTD Input Module: Channel 3 rate change alarm lower limit flag
Input	XGF-RD8A_CH3_RAH	BIT	Uxy.05.7	RTD Input Module: Channel 3 rate change alarm upper limit flag
Input	XGF-RD8A_CH4_RAL	BIT	Uxy.05.8	RTD Input Module: Channel 4 rate change alarm lower limit flag
Input	XGF-RD8A_CH4_RAH	BIT	Uxy.05.9	RTD Input Module: Channel 4 rate change alarm upper limit flag
Input	XGF-RD8A_CH5_RAL	BIT	Uxy.05.A	RTD Input Module: Channel 5 rate change alarm lower limit flag
Input	XGF-RD8A_CH5_RAH	BIT	Uxy.05.B	RTD Input Module: Channel 5 rate change alarm upper limit flag
Input	XGF-RD8A_CH6_RAL	BIT	Uxy.05.C	RTD Input Module: Channel 6 rate change alarm lower limit flag
Input	XGF-RD8A_CH6_RAH	BIT	Uxy.05.D	RTD Input Module: Channel 6 rate change alarm upper limit flag
Input	XGF-RD8A_CH7_RAL	BIT	Uxy.05.E	RTD Input Module: Channel 7 rate change alarm lower limit flag
Input	XGF-RD8A_CH7_RAH	BIT	Uxy.05.F	RTD Input Module: Channel 7 rate change alarm upper limit flag
Input	XGF-RD8A_CH0_TEMP	Word	Uxy.06	RTD Input Module: Channel 0 temperature data
Input	XGF-RD8A_CH1_TEMP	Word	Uxy.07	RTD Input Module: Channel 1 temperature data
Input	XGF-RD8A_CH2_TEMP	Word	Uxy.08	RTD Input Module: Channel 2 temperature data

Appendix

Input	XGF-RD8A_CH3_TEMP	Word	Uxy.09	RTD Input Module: Channel 3 temperature data
Input	XGF-RD8A_CH4_TEMP	Word	Uxy.10	RTD Input Module: Channel 4 temperature data
Input	XGF-RD8A_CH5_TEMP	Word	Uxy.11	RTD Input Module: Channel 5 temperature data
Input	XGF-RD8A_CH6_TEMP	Word	Uxy.12	RTD Input Module: Channel 6 temperature data
Input	XGF-RD8A_CH7_TEMP	Word	Uxy.13	RTD Input Module: Channel 7 temperature data
Input	XGF-RD8A_CH0_SCAL	Word	Uxy.14	RTD Input Module: Channel 0 scaling data
Input	XGF-RD8A_CH1_SCAL	Word	Uxy.15	RTD Input Module: Channel 1 scaling data
Input	XGF-RD8A_CH2_SCAL	Word	Uxy.16	RTD Input Module: Channel 2 scaling data
Input	XGF-RD8A_CH3_SCAL	Word	Uxy.17	RTD Input Module: Channel 3 scaling data
Input	XGF-RD8A_CH4_SCAL	Word	Uxy.18	RTD Input Module: Channel 4 scaling data
Input	XGF-RD8A_CH5_SCAL	Word	Uxy.19	RTD Input Module: Channel 5 scaling data
Input	XGF-RD8A_CH6_SCAL	Word	Uxy.20	RTD Input Module: Channel 6 scaling data
Input	XGF-RD8A_CH7_SCAL	Word	Uxy.21	RTD Input Module: Channel 7 scaling data
Output	XGF-RD8A_CH0_FINDEN	BIT	Uxy.22.0	RTD Input Module: Channel 0 Max./Min. search enable/disable
Output	XGF-RD8A_CH1_FINDEN	BIT	Uxy.22.1	RTD Input Module: Channel 1 Max./Min. search enable/disable
Output	XGF-RD8A_CH2_FINDEN	BIT	Uxy.22.2	RTD Input Module: Channel 2 Max./Min. search enable/disable
Output	XGF-RD8A_CH3_FINDEN	BIT	Uxy.22.3	RTD Input Module: Channel 3 Max./Min. search enable/disable
Output	XGF-RD8A_CH4_FINDEN	BIT	Uxy.22.4	RTD Input Module: Channel 4 Max./Min. search enable/disable
Output	XGF-RD8A_CH5_FINDEN	BIT	Uxy.22.5	RTD Input Module: Channel 5 Max./Min. search enable/disable
Output	XGF-RD8A_CH6_FINDEN	BIT	Uxy.22.6	RTD Input Module: Channel 6 Max./Min. search enable/disable
Output	XGF-RD8A_CH7_FINDEN	BIT	Uxy.22.7	RTD Input Module: Channel 7 Max./Min. search enable/disable
Output	XGF-RD8A_CH0_ALMEN	BIT	Uxy.22.8	RTD Input Module: Channel 0 alarm(PVA/RCA) enable/disable
Output	XGF-RD8A_CH1_ALMEN	BIT	Uxy.22.9	RTD Input Module: Channel 1 alarm(PVA/RCA) enable/disable
Output	XGF-RD8A_CH2_ALMEN	BIT	Uxy.22.A	RTD Input Module: Channel 2 alarm(PVA/RCA) enable/disable
Output	XGF-RD8A_CH3_ALMEN	BIT	Uxy.22.B	RTD Input Module: Channel 3 alarm(PVA/RCA) enable/disable
Output	XGF-RD8A_CH4_ALMEN	BIT	Uxy.22.C	RTD Input Module: Channel 4 alarm(PVA/RCA) enable/disable
Output	XGF-RD8A_CH5_ALMEN	BIT	Uxy.22.D	RTD Input Module: Channel 5 alarm(PVA/RCA) enable/disable
Output	XGF-RD8A_CH6_ALMEN	BIT	Uxy.22.E	RTD Input Module: Channel 6 alarm(PVA/RCA) enable/disable
Output	XGF-RD8A_CH7_ALMEN	BIT	Uxy.22.F	RTD Input Module: Channel 7 alarm(PVA/RCA) enable/disable

2) Refresh data

<Input>

Input/Output	Variable	Type	Word(16BIT) Offset	Comment
Input	XGF-RD8A_CH0_ADJERR	BIT	0.0	RTD Input Module: Channel 0 offset/Gain error flag
Input	XGF-RD8A_CH1_ADJERR	BIT	0.1	RTD Input Module: Channel 1 offset/Gain error flag
Input	XGF-RD8A_CH2_ADJERR	BIT	0.2	RTD Input Module: Channel 2 offset/Gain error flag
Input	XGF-RD8A_CH3_ADJERR	BIT	0.3	RTD Input Module: Channel 3 offset/Gain error flag
Input	XGF-RD8A_CH4_ADJERR	BIT	0.4	RTD Input Module: Channel 4 offset/Gain error flag
Input	XGF-RD8A_CH5_ADJERR	BIT	0.5	RTD Input Module: Channel 5 offset/Gain error flag
Input	XGF-RD8A_CH6_ADJERR	BIT	0.6	RTD Input Module: Channel 6 offset/Gain error flag
Input	XGF-RD8A_CH7_ADJERR	BIT	0.7	RTD Input Module: Channel 7 offset/Gain error flag
Input	XGF-RD8A_EEPROMERR	BIT	0.D	RTD Input Module: Offset/Gain backup error flag
Input	XGF-RD8A_WDT_ERR	BIT	0.E	RTD Input Module: H/W Error Flag
Input	XGF-RD8A_RDY	BIT	0.F	RTD Input Module: Module ready
Input	XGF-RD8A_CH0_ACT	BIT	1.0	RTD Input Module: CH0 RUN
Input	XGF-RD8A_CH1_ACT	BIT	1.1	RTD Input Module: CH1 RUN

Input	XGF-RD8A_CH2_ACT	BIT	1.2	RTD Input Module: CH2 RUN
Input	XGF-RD8A_CH3_ACT	BIT	1.3	RTD Input Module: CH3 RUN
Input	XGF-RD8A_CH4_ACT	BIT	1.4	RTD Input Module: CH4 RUN
Input	XGF-RD8A_CH5_ACT	BIT	1.5	RTD Input Module: CH5 RUN
Input	XGF-RD8A_CH6_ACT	BIT	1.6	RTD Input Module: CH6 RUN
Input	XGF-RD8A_CH7_ACT	BIT	1.7	RTD Input Module: CH7 RUN
Input	XGF-RD8A_CH0_BOUT	BIT	1.8	RTD Input Module: Channel 0 disconnection flag
Input	XGF-RD8A_CH1_BOUT	BIT	1.9	RTD Input Module: Channel 1 disconnection flag
Input	XGF-RD8A_CH2_BOUT	BIT	1.A	RTD Input Module: Channel 2 disconnection flag
Input	XGF-RD8A_CH3_BOUT	BIT	1.B	RTD Input Module: Channel 3 disconnection flag
Input	XGF-RD8A_CH4_BOUT	BIT	1.C	RTD Input Module: Channel 4 disconnection flag
Input	XGF-RD8A_CH5_BOUT	BIT	1.D	RTD Input Module: Channel 5 disconnection flag
Input	XGF-RD8A_CH6_BOUT	BIT	1.E	RTD Input Module: Channel 6 disconnection flag
Input	XGF-RD8A_CH7_BOUT	BIT	1.F	RTD Input Module: Channel 7 disconnection flag
Input	XGF-RD8A_CH0_SETERR	BIT	2.0	RTD Input Module: Channel 0 error code
Input	XGF-RD8A_CH1_SETERR	BIT	2.1	RTD Input Module: Channel 1 error code
Input	XGF-RD8A_CH2_SETERR	BIT	2.2	RTD Input Module: Channel 2 error code
Input	XGF-RD8A_CH3_SETERR	BIT	2.3	RTD Input Module: Channel 3 error code
Input	XGF-RD8A_CH4_SETERR	BIT	2.4	RTD Input Module: Channel 4 error code
Input	XGF-RD8A_CH5_SETERR	BIT	2.5	RTD Input Module: Channel 5 error code
Input	XGF-RD8A_CH6_SETERR	BIT	2.6	RTD Input Module: Channel 6 error code
Input	XGF-RD8A_CH7_SETERR	BIT	2.7	RTD Input Module: Channel 7 error code
Input	XGF-RD8A_CH0_PALL	BIT	3.0	RTD Input Module: Channel 0 process alarm ultra lower limit flag
Input	XGF-RD8A_CH0_PAL	BIT	3.1	RTD Input Module: Channel 0 process alarm lower limit flag
Input	XGF-RD8A_CH0_PAH	BIT	3.2	RTD Input Module: Channel 0 process alarm upper limit flag
Input	XGF-RD8A_CH0_PAHH	BIT	3.3	RTD Input Module: Channel 0 process alarm ultra upper limit flag
Input	XGF-RD8A_CH1_PALL	BIT	3.4	RTD Input Module: Channel 1 process alarm ultra lower limit flag
Input	XGF-RD8A_CH1_PAL	BIT	3.5	RTD Input Module: Channel 1 process alarm lower limit flag
Input	XGF-RD8A_CH1_PAH	BIT	3.6	RTD Input Module: Channel 1 process alarm upper limit flag
Input	XGF-RD8A_CH1_PAHH	BIT	3.7	RTD Input Module: Channel 1 process alarm ultra upper limit flag
Input	XGF-RD8A_CH2_PALL	BIT	3.8	RTD Input Module: Channel 2 process alarm ultra lower limit flag
Input	XGF-RD8A_CH2_PAL	BIT	3.9	RTD Input Module: Channel 2 process alarm lower limit flag
Input	XGF-RD8A_CH2_PAH	BIT	3.A	RTD Input Module: Channel 2 process alarm upper limit flag
Input	XGF-RD8A_CH2_PAHH	BIT	3.B	RTD Input Module: Channel 2 process alarm ultra upper limit flag
Input	XGF-RD8A_CH3_PALL	BIT	3.C	RTD Input Module: Channel 3 process alarm ultra lower limit flag
Input	XGF-RD8A_CH3_PAL	BIT	3.D	RTD Input Module: Channel 3 process alarm lower limit flag
Input	XGF-RD8A_CH3_PAH	BIT	3.E	RTD Input Module: Channel 3 process alarm upper limit flag
Input	XGF-RD8A_CH3_PAHH	BIT	3.F	RTD Input Module: Channel 3 process alarm ultra upper limit

Appendix

				flag
Input	XGF-RD8A_CH4_PALL	BIT	4.0	RTD Input Module: Channel 4 process alarm ultra lower limit flag
Input	XGF-RD8A_CH4_PAL	BIT	4.1	RTD Input Module: Channel 4 process alarm lower limit flag
Input	XGF-RD8A_CH4_PAH	BIT	4.2	RTD Input Module: Channel 4 process alarm upper limit flag
Input	XGF-RD8A_CH4_PAHH	BIT	4.3	RTD Input Module: Channel 4 process alarm ultra upper limit flag
Input	XGF-RD8A_CH5_PALL	BIT	4.4	RTD Input Module: Channel 5 process alarm ultra lower limit flag
Input	XGF-RD8A_CH5_PAL	BIT	4.5	RTD Input Module: Channel 5 process alarm lower limit flag
Input	XGF-RD8A_CH5_PAH	BIT	4.6	RTD Input Module: Channel 5 process alarm upper limit flag
Input	XGF-RD8A_CH5_PAHH	BIT	4.7	RTD Input Module: Channel 5 process alarm ultra upper limit flag
Input	XGF-RD8A_CH6_PALL	BIT	4.8	RTD Input Module: Channel 6 process alarm ultra lower limit flag
Input	XGF-RD8A_CH6_PAL	BIT	4.9	RTD Input Module: Channel 6 process alarm lower limit flag
Input	XGF-RD8A_CH6_PAH	BIT	4.A	RTD Input Module: Channel 6 process alarm upper limit flag
Input	XGF-RD8A_CH6_PAHH	BIT	4.B	RTD Input Module: Channel 6 process alarm ultra upper limit flag
Input	XGF-RD8A_CH7_PALL	BIT	4.C	RTD Input Module: Channel 7 process alarm ultra lower limit flag
Input	XGF-RD8A_CH7_PAL	BIT	4.D	RTD Input Module: Channel 7 process alarm lower limit flag
Input	XGF-RD8A_CH7_PAH	BIT	4.E	RTD Input Module: Channel 7 process alarm upper limit flag
Input	XGF-RD8A_CH7_PAHH	BIT	4.F	RTD Input Module: Channel 7 process alarm ultra upper limit flag
Input	XGF-RD8A_CH0_RAL	BIT	5.0	RTD Input Module: Channel 0 rate change alarm lower limit flag
Input	XGF-RD8A_CH0_RAH	BIT	5.1	RTD Input Module: Channel 0 rate change alarm upper limit flag
Input	XGF-RD8A_CH1_RAL	BIT	5.2	RTD Input Module: Channel 1 rate change alarm lower limit flag
Input	XGF-RD8A_CH1_RAH	BIT	5.3	RTD Input Module: Channel 1 rate change alarm upper limit flag
Input	XGF-RD8A_CH2_RAL	BIT	5.4	RTD Input Module: Channel 2 rate change alarm lower limit flag
Input	XGF-RD8A_CH2_RAH	BIT	5.5	RTD Input Module: Channel 2 rate change alarm upper limit flag
Input	XGF-RD8A_CH3_RAL	BIT	5.6	RTD Input Module: Channel 3 rate change alarm lower limit flag
Input	XGF-RD8A_CH3_RAH	BIT	5.7	RTD Input Module: Channel 3 rate change alarm upper limit flag
Input	XGF-RD8A_CH4_RAL	BIT	5.8	RTD Input Module: Channel 4 rate change alarm lower limit flag
Input	XGF-RD8A_CH4_RAH	BIT	5.9	RTD Input Module: Channel 4 rate change alarm upper limit flag
Input	XGF-RD8A_CH5_RAL	BIT	5.A	RTD Input Module: Channel 5 rate change alarm lower limit flag
Input	XGF-RD8A_CH5_RAH	BIT	5.B	RTD Input Module: Channel 5 rate change alarm upper limit flag
Input	XGF-RD8A_CH6_RAL	BIT	5.C	RTD Input Module: Channel 6 rate change alarm lower limit flag
Input	XGF-RD8A_CH6_RAH	BIT	5.D	RTD Input Module: Channel 6 rate change alarm upper limit flag
Input	XGF-RD8A_CH7_RAL	BIT	5.E	RTD Input Module: Channel 7 rate change alarm lower limit flag
Input	XGF-RD8A_CH7_RAH	BIT	5.F	RTD Input Module: Channel 7 rate change alarm upper limit flag
Input	XGF-RD8A_CH0_TEMP	Word	6	RTD Input Module: Channel 0 temperature data
Input	XGF-RD8A_CH1_TEMP	Word	7	RTD Input Module: Channel 1 temperature data
Input	XGF-RD8A_CH2_TEMP	Word	8	RTD Input Module: Channel 2 temperature data
Input	XGF-RD8A_CH3_TEMP	Word	9	RTD Input Module: Channel 3 temperature data
Input	XGF-RD8A_CH4_TEMP	Word	10	RTD Input Module: Channel 4 temperature data
Input	XGF-RD8A_CH5_TEMP	Word	11	RTD Input Module: Channel 5 temperature data

Input	XGF-RD8A_CH6_TEMP	Word	12	RTD Input Module: Channel 6 temperature data
Input	XGF-RD8A_CH7_TEMP	Word	13	RTD Input Module: Channel 7 temperature data
Input	XGF-RD8A_CH0_SCAL	Word	14	RTD Input Module: Channel 0 scaling data
Input	XGF-RD8A_CH1_SCAL	Word	15	RTD Input Module: Channel 1 scaling data
Input	XGF-RD8A_CH2_SCAL	Word	16	RTD Input Module: Channel 2 scaling data
Input	XGF-RD8A_CH3_SCAL	Word	17	RTD Input Module: Channel 3 scaling data
Input	XGF-RD8A_CH4_SCAL	Word	18	RTD Input Module: Channel 4 scaling data
Input	XGF-RD8A_CH5_SCAL	Word	19	RTD Input Module: Channel 5 scaling data
Input	XGF-RD8A_CH6_SCAL	Word	20	RTD Input Module: Channel 6 scaling data
Input	XGF-RD8A_CH7_SCAL	Word	21	RTD Input Module: Channel 7 scaling data

<Output>

Input/Output	Variable	Type	Word(16BIT) Offset	Comment
Output	XGF-RD8A_CH0_FINDEN	BIT	0.0	RTD Input Module: Channel 0 Max./Min. search enable/disable
Output	XGF-RD8A_CH1_FINDEN	BIT	0.1	RTD Input Module: Channel 1 Max./Min. search enable/disable
Output	XGF-RD8A_CH2_FINDEN	BIT	0.2	RTD Input Module: Channel 2 Max./Min. search enable/disable
Output	XGF-RD8A_CH3_FINDEN	BIT	0.3	RTD Input Module: Channel 3 Max./Min. search enable/disable
Output	XGF-RD8A_CH4_FINDEN	BIT	0.4	RTD Input Module: Channel 4 Max./Min. search enable/disable
Output	XGF-RD8A_CH5_FINDEN	BIT	0.5	RTD Input Module: Channel 5 Max./Min. search enable/disable
Output	XGF-RD8A_CH6_FINDEN	BIT	0.6	RTD Input Module: Channel 6 Max./Min. search enable/disable
Output	XGF-RD8A_CH7_FINDEN	BIT	0.7	RTD Input Module: Channel 7 Max./Min. search enable/disable
Output	XGF-RD8A_CH0_ALMEN	BIT	0.8	RTD Input Module: Channel 0 alarm(PVA/RCA) enable/disable
Output	XGF-RD8A_CH1_ALMEN	BIT	0.9	RTD Input Module: Channel 1 alarm(PVA/RCA) enable/disable
Output	XGF-RD8A_CH2_ALMEN	BIT	0.A	RTD Input Module: Channel 2 alarm(PVA/RCA) enable/disable
Output	XGF-RD8A_CH3_ALMEN	BIT	0.B	RTD Input Module: Channel 3 alarm(PVA/RCA) enable/disable
Output	XGF-RD8A_CH4_ALMEN	BIT	0.C	RTD Input Module: Channel 4 alarm(PVA/RCA) enable/disable
Output	XGF-RD8A_CH5_ALMEN	BIT	0.D	RTD Input Module: Channel 5 alarm(PVA/RCA) enable/disable
Output	XGF-RD8A_CH6_ALMEN	BIT	0.E	RTD Input Module: Channel 6 alarm(PVA/RCA) enable/disable
Output	XGF-RD8A_CH7_ALMEN	BIT	0.F	RTD Input Module: Channel 7 alarm(PVA/RCA) enable/disable

(20) XGF-RD4A

1) U Device

Input/Output	Variable	Type	Device	Comment
Input	XGF-RD4A_CH0_ADJERR	BIT	Uxy.00.0	Temperature input module Channel 0 offset/Gain error flag
Input	XGF-RD4A_CH1_ADJERR	BIT	Uxy.00.1	Temperature input module Channel 1 offset/Gain error flag
Input	XGF-RD4A_CH2_ADJERR	BIT	Uxy.00.2	Temperature input module Channel 2 offset/Gain error flag
Input	XGF-RD4A_CH3_ADJERR	BIT	Uxy.00.3	Temperature input module Channel 3 offset/Gain error flag

Appendix

Input	XGF-RD4A_EEPROMERR	BIT	Uxy.00.D	Temperature	input module Offset/Gain backup error flag
Input	XGF-RD4A_WDT_ERR	BIT	Uxy.00.E	Temperature	input module H/W Error Flag
Input	XGF-RD4A_RDY	BIT	Uxy.00.F	Temperature	input module Module ready
Input	XGF-RD4A_CH0_ACT	BIT	Uxy.01.0	Temperature	input module CH0 RUN
Input	XGF-RD4A_CH1_ACT	BIT	Uxy.01.1	Temperature	input module CH1 RUN
Input	XGF-RD4A_CH2_ACT	BIT	Uxy.01.2	Temperature	input module CH2 RUN
Input	XGF-RD4A_CH3_ACT	BIT	Uxy.01.3	Temperature	input module CH3 RUN
Input	XGF-RD4A_CH0_BOUT	BIT	Uxy.01.4	Temperature	input module Channel 0 disconnection flag
Input	XGF-RD4A_CH1_BOUT	BIT	Uxy.01.5	Temperature	input module Channel 1 disconnection flag
Input	XGF-RD4A_CH2_BOUT	BIT	Uxy.01.6	Temperature	input module Channel 2 disconnection flag
Input	XGF-RD4A_CH3_BOUT	BIT	Uxy.01.7	Temperature	input module Channel 3 disconnection flag
Input	XGF-RD4A_CH0_SETERR	BIT	Uxy.01.8	Temperature	input module Channel 0 error code
Input	XGF-RD4A_CH1_SETERR	BIT	Uxy.01.9	Temperature	input module Channel 1 error code
Input	XGF-RD4A_CH2_SETERR	BIT	Uxy.01.A	Temperature	input module Channel 2 error code
Input	XGF-RD4A_CH3_SETERR	BIT	Uxy.01.B	Temperature	input module Channel 3 error code
Input	XGF-RD4A_CH0_PALL	BIT	Uxy.02.0	Temperature	input module Channel 0 process alarm ultra lower limit flag
Input	XGF-RD4A_CH0_PAL	BIT	Uxy.02.1	Temperature	input module Channel 0 process alarm lower limit flag
Input	XGF-RD4A_CH0_PAH	BIT	Uxy.02.2	Temperature	input module Channel 0 process alarm upper limit flag
Input	XGF-RD4A_CH0_PAHH	BIT	Uxy.02.3	Temperature	input module Channel 0 process alarm ultra upper limit flag
Input	XGF-RD4A_CH1_PALL	BIT	Uxy.02.4	Temperature	input module Channel 1 process alarm ultra lower limit flag
Input	XGF-RD4A_CH1_PAL	BIT	Uxy.02.5	Temperature	input module Channel 1 process alarm lower limit flag
Input	XGF-RD4A_CH1_PAH	BIT	Uxy.02.6	Temperature	input module Channel 1 process alarm upper limit flag
Input	XGF-RD4A_CH1_PAHH	BIT	Uxy.02.7	Temperature	input module Channel 1 process alarm ultra upper limit flag
Input	XGF-RD4A_CH2_PALL	BIT	Uxy.02.8	Temperature	input module Channel 2 process alarm ultra lower limit flag
Input	XGF-RD4A_CH2_PAL	BIT	Uxy.02.9	Temperature	input module Channel 2 process alarm lower limit flag
Input	XGF-RD4A_CH2_PAH	BIT	Uxy.02.A	Temperature	input module Channel 2 process alarm upper limit flag
Input	XGF-RD4A_CH2_PAHH	BIT	Uxy.02.B	Temperature	input module Channel 2 process alarm ultra upper limit flag
Input	XGF-RD4A_CH3_PALL	BIT	Uxy.02.C	Temperature	input module Channel 3 process alarm ultra lower limit flag
Input	XGF-RD4A_CH3_PAL	BIT	Uxy.02.D	Temperature	input module Channel 3 process alarm lower limit flag
Input	XGF-RD4A_CH3_PAH	BIT	Uxy.02.E	Temperature	input module Channel 3 process alarm upper limit flag
Input	XGF-RD4A_CH3_PAHH	BIT	Uxy.02.F	Temperature	input module Channel 3 process alarm ultra upper limit flag
Input	XGF-RD4A_CH0_RAL	BIT	Uxy.03.0	Temperature	input module Channel 0 rate change alarm lower limit flag
Input	XGF-RD4A_CH0_RAH	BIT	Uxy.03.1	Temperature	input module Channel 0 rate change alarm upper limit flag
Input	XGF-RD4A_CH1_RAL	BIT	Uxy.03.4	Temperature	input module Channel 1 rate change alarm lower limit flag
Input	XGF-RD4A_CH1_RAH	BIT	Uxy.03.5	Temperature	input module Channel 1 rate change alarm upper limit flag
Input	XGF-RD4A_CH2_RAL	BIT	Uxy.03.8	Temperature	input module Channel 2 rate change alarm lower limit flag
Input	XGF-RD4A_CH2_RAH	BIT	Uxy.03.9	Temperature	input module Channel 2 rate change alarm upper limit flag
Input	XGF-RD4A_CH3_RAL	BIT	Uxy.03.C	Temperature	input module Channel 3 rate change alarm lower limit flag
Input	XGF-RD4A_CH3_RAH	BIT	Uxy.03.D	Temperature	input module Channel 3 rate change alarm upper limit flag
Output	XGF-RD4A_CH0_FINDEN	BIT	Uxy.29.0	Temperature	input module Channel 0 Max./Min. search enable/disable
Output	XGF-RD4A_CH1_FINDEN	BIT	Uxy.29.1	Temperature	input module Channel 1 Max./Min. search enable/disable
Output	XGF-RD4A_CH2_FINDEN	BIT	Uxy.29.2	Temperature	input module Channel 2 Max./Min. search enable/disable
Output	XGF-RD4A_CH3_FINDEN	BIT	Uxy.29.3	Temperature	input module Channel 3 Max./Min. search enable/disable
Output	XGF-RD4A_CH0_ALMEN	BIT	Uxy.29.4	Temperature	input module Channel 0 alarm(PVA/RCA) enable/disable
Output	XGF-RD4A_CH1_ALMEN	BIT	Uxy.29.5	Temperature	input module Channel 1 alarm(PVA/RCA) enable/disable
Output	XGF-RD4A_CH2_ALMEN	BIT	Uxy.29.6	Temperature	input module Channel 2 alarm(PVA/RCA) enable/disable
Output	XGF-RD4A_CH3_ALMEN	BIT	Uxy.29.7	Temperature	input module Channel 3 alarm(PVA/RCA) enable/disable
Input	XGF-RD4A_CH0_TEMP	Word	Uxy.04	Temperature	input module Channel 0 temperature data
Input	XGF-RD4A_CH1_TEMP	Word	Uxy.05	Temperature	input module Channel 1 temperature data

Input	XGF-RD4A_CH2_TEMP	Word	Uxy.06	Temperature	input module Channel 2 temperature data
Input	XGF-RD4A_CH3_TEMP	Word	Uxy.07	Temperature	input module Channel 3 temperature data
Input	XGF-RD4A_CH0_SCAL	Word	Uxy.08	Temperature	input module Channel 0 scaling data
Input	XGF-RD4A_CH1_SCAL	Word	Uxy.09	Temperature	input module Channel 1 scaling data
Input	XGF-RD4A_CH2_SCAL	Word	Uxy.10	Temperature	input module Channel 2 scaling data
Input	XGF-RD4A_CH3_SCAL	Word	Uxy.11	Temperature	input module Channel 3 scaling data
Input	XGF-RD4A_CH0_MIN	Word	Uxy.12	Temperature	input module Channel 0 temperature Min. data
Input	XGF-RD4A_CH0_MAX	Word	Uxy.13	Temperature	input module Channel 0 temperature Max. data
Input	XGF-RD4A_CH1_MIN	Word	Uxy.14	Temperature	input module Channel 1 temperature Min. data
Input	XGF-RD4A_CH1_MAX	Word	Uxy.15	Temperature	input module Channel 1 temperature Max. data
Input	XGF-RD4A_CH2_MIN	Word	Uxy.16	Temperature	input module Channel 2 temperature Min. data
Input	XGF-RD4A_CH2_MAX	Word	Uxy.17	Temperature	input module Channel 2 temperature Max. data
Input	XGF-RD4A_CH3_MIN	Word	Uxy.18	Temperature	input module Channel 3 temperature Min. data
Input	XGF-RD4A_CH3_MAX	Word	Uxy.19	Temperature	input module Channel 3 temperature Max. data
Input	XGF-RD4A_CH0_TIMEL	Word	Uxy.20	Temperature	input module Channel 0 data upload time
Input	XGF-RD4A_CH0_TIMEH	Word	Uxy.21	Temperature	input module Channel 0 data upload time
Input	XGF-RD4A_CH1_TIMEL	Word	Uxy.22	Temperature	input module Channel 1 data upload time
Input	XGF-RD4A_CH1_TIMEH	Word	Uxy.23	Temperature	input module Channel 1 data upload time
Input	XGF-RD4A_CH2_TIMEL	Word	Uxy.24	Temperature	input module Channel 2 data upload time
Input	XGF-RD4A_CH2_TIMEH	Word	Uxy.25	Temperature	input module Channel 2 data upload time
Input	XGF-RD4A_CH3_TIMEL	Word	Uxy.26	Temperature	input module Channel 3 data upload time
Input	XGF-RD4A_CH3_TIMEH	Word	Uxy.27	Temperature	input module Channel 3 data upload time

2) Refresh data

<Input>

Input/Output	Variable	Type	Word(16BIT) Offset	Comment
Input	XGF-RD4A_CH0_ADJERR	BIT	0.0	Temperature input module Channel 0 offset/Gain error flag
Input	XGF-RD4A_CH1_ADJERR	BIT	0.1	Temperature input module Channel 1 offset/Gain error flag
Input	XGF-RD4A_CH2_ADJERR	BIT	0.2	Temperature input module Channel 2 offset/Gain error flag
Input	XGF-RD4A_CH3_ADJERR	BIT	0.3	Temperature input module Channel 3 offset/Gain error flag
Input	XGF-RD4A_EEPROMERR	BIT	0.D	Temperature input module Offset/Gain backup error flag
Input	XGF-RD4A_WDT_ERR	BIT	0.E	Temperature input module H/W Error Flag
Input	XGF-RD4A_RDY	BIT	0.F	Temperature input module Module ready
Input	XGF-RD4A_CH0_ACT	BIT	1.0	Temperature input module CH0 RUN
Input	XGF-RD4A_CH1_ACT	BIT	1.1	Temperature input module CH1 RUN
Input	XGF-RD4A_CH2_ACT	BIT	1.2	Temperature input module CH2 RUN
Input	XGF-RD4A_CH3_ACT	BIT	1.3	Temperature input module CH3 RUN
Input	XGF-RD4A_CH0_BOUT	BIT	1.4	Temperature input module Channel 0 disconnection flag
Input	XGF-RD4A_CH1_BOUT	BIT	1.5	Temperature input module Channel 1 disconnection flag

Appendix

Input	XGF-RD4A_CH2_BOUT	BIT	1.6	Temperature	input module Channel 2 disconnection flag
Input	XGF-RD4A_CH3_BOUT	BIT	1.7	Temperature	input module Channel 3 disconnection flag
Input	XGF-RD4A_CH0_SETERR	BIT	1.8	Temperature	input module Channel 0 error code
Input	XGF-RD4A_CH1_SETERR	BIT	1.9	Temperature	input module Channel 1 error code
Input	XGF-RD4A_CH2_SETERR	BIT	1.A	Temperature	input module Channel 2 error code
Input	XGF-RD4A_CH3_SETERR	BIT	1.B	Temperature	input module Channel 3 error code
Input	XGF-RD4A_CH0_PALL	BIT	2.0	Temperature limit flag	input module Channel 0 process alarm ultra lower limit flag
Input	XGF-RD4A_CH0_PAL	BIT	2.1	Temperature flag	input module Channel 0 process alarm lower limit flag
Input	XGF-RD4A_CH0_PAH	BIT	2.2	Temperature flag	input module Channel 0 process alarm upper limit flag
Input	XGF-RD4A_CH0_PAHH	BIT	2.3	Temperature limit flag	input module Channel 0 process alarm ultra upper limit flag
Input	XGF-RD4A_CH1_PALL	BIT	2.4	Temperature limit flag	input module Channel 1 process alarm ultra lower limit flag
Input	XGF-RD4A_CH1_PAL	BIT	2.5	Temperature flag	input module Channel 1 process alarm lower limit flag
Input	XGF-RD4A_CH1_PAH	BIT	2.6	Temperature flag	input module Channel 1 process alarm upper limit flag
Input	XGF-RD4A_CH1_PAHH	BIT	2.7	Temperature limit flag	input module Channel 1 process alarm ultra upper limit flag
Input	XGF-RD4A_CH2_PALL	BIT	2.8	Temperature limit flag	input module Channel 2 process alarm ultra lower limit flag
Input	XGF-RD4A_CH2_PAL	BIT	2.9	Temperature flag	input module Channel 2 process alarm lower limit flag
Input	XGF-RD4A_CH2_PAH	BIT	2.A	Temperature flag	input module Channel 2 process alarm upper limit flag
Input	XGF-RD4A_CH2_PAHH	BIT	2.B	Temperature limit flag	input module Channel 2 process alarm ultra upper limit flag
Input	XGF-RD4A_CH3_PALL	BIT	2.C	Temperature limit flag	input module Channel 3 process alarm ultra lower limit flag
Input	XGF-RD4A_CH3_PAL	BIT	2.D	Temperature flag	input module Channel 3 process alarm lower limit flag
Input	XGF-RD4A_CH3_PAH	BIT	2.E	Temperature flag	input module Channel 3 process alarm upper limit flag
Input	XGF-RD4A_CH3_PAHH	BIT	2.F	Temperature limit flag	input module Channel 3 process alarm ultra upper limit flag
Input	XGF-RD4A_CH0_RAL	BIT	3.0	Temperature limit flag	input module Channel 0 rate change alarm lower limit flag
Input	XGF-RD4A_CH0_RAH	BIT	3.1	Temperature limit flag	input module Channel 0 rate change alarm upper limit flag
Input	XGF-RD4A_CH1_RAL	BIT	3.4	Temperature	input module Channel 1 rate change alarm lower

				limit flag
Input	XGF-RD4A_CH1_RAH	BIT	3.5	Temperature input module Channel 1 rate change alarm upper limit flag
Input	XGF-RD4A_CH2_RAL	BIT	3.8	Temperature input module Channel 2 rate change alarm lower limit flag
Input	XGF-RD4A_CH2_RAH	BIT	3.9	Temperature input module Channel 2 rate change alarm upper limit flag
Input	XGF-RD4A_CH3_RAL	BIT	3.C	Temperature input module Channel 3 rate change alarm lower limit flag
Input	XGF-RD4A_CH3_RAH	BIT	3.D	Temperature input module Channel 3 rate change alarm upper limit flag
Input	XGF-RD4A_CH0_TEMP	Word	4	Temperature input module Channel 0 temperature data
Input	XGF-RD4A_CH1_TEMP	Word	5	Temperature input module Channel 1 temperature data
Input	XGF-RD4A_CH2_TEMP	Word	6	Temperature input module Channel 2 temperature data
Input	XGF-RD4A_CH3_TEMP	Word	7	Temperature input module Channel 3 temperature data
Input	XGF-RD4A_CH0_SCAL	Word	8	Temperature input module Channel 0 scaling data
Input	XGF-RD4A_CH1_SCAL	Word	9	Temperature input module Channel 1 scaling data
Input	XGF-RD4A_CH2_SCAL	Word	10	Temperature input module Channel 2 scaling data
Input	XGF-RD4A_CH3_SCAL	Word	11	Temperature input module Channel 3 scaling data
Input	XGF-RD4A_CH0_MIN	Word	12	Temperature input module Channel 0 temperature Min. data
Input	XGF-RD4A_CH0_MAX	Word	13	Temperature input module Channel 0 temperature Max. data
Input	XGF-RD4A_CH1_MIN	Word	14	Temperature input module Channel 1 temperature Min. data
Input	XGF-RD4A_CH1_MAX	Word	15	Temperature input module Channel 1 temperature Max. data
Input	XGF-RD4A_CH2_MIN	Word	16	Temperature input module Channel 2 temperature Min. data
Input	XGF-RD4A_CH2_MAX	Word	17	Temperature input module Channel 2 temperature Max. data
Input	XGF-RD4A_CH3_MIN	Word	18	Temperature input module Channel 3 temperature Min. data
Input	XGF-RD4A_CH3_MAX	Word	19	Temperature input module Channel 3 temperature Max. data
Input	XGF-RD4A_CH0_TIMEL	Word	20	Temperature input module Channel 0 data upload time
Input	XGF-RD4A_CH0_TIMEH	Word	21	Temperature input module Channel 0 data upload time
Input	XGF-RD4A_CH1_TIMEL	Word	22	Temperature input module Channel 1 data upload time
Input	XGF-RD4A_CH1_TIMEH	Word	23	Temperature input module Channel 1 data upload time
Input	XGF-RD4A_CH2_TIMEL	Word	24	Temperature input module Channel 2 data upload time
Input	XGF-RD4A_CH2_TIMEH	Word	25	Temperature input module Channel 2 data upload time
Input	XGF-RD4A_CH3_TIMEL	Word	26	Temperature input module Channel 3 data upload time
Input	XGF-RD4A_CH3_TIMEH	Word	27	Temperature input module Channel 3 data upload time
Input		WORD	28	Reserved

<Output>

Input/Output	Variable	Type	Word(16BIT) Offset	Comment
Output	XGF-RD4A_CH0_FINDEN	BIT	0.0	Temperature input module Channel 0 Max./Min. search enable/disable
Output	XGF-RD4A_CH1_FINDEN	BIT	0.1	Temperature input module Channel 1 Max./Min. search enable/disable
Output	XGF-RD4A_CH2_FINDEN	BIT	0.2	Temperature input module Channel 2 Max./Min. search enable/disable
Output	XGF-RD4A_CH3_FINDEN	BIT	0.3	Temperature input module Channel 3 Max./Min. search enable/disable
Output	XGF-RD4A_CH0_ALMEN	BIT	0.4	Temperature input module Channel 0 alarm(PVA/RCA) enable/disable
Output	XGF-RD4A_CH1_ALMEN	BIT	0.5	Temperature input module Channel 1 alarm(PVA/RCA) enable/disable
Output	XGF-RD4A_CH2_ALMEN	BIT	0.6	Temperature input module Channel 2 alarm(PVA/RCA) enable/disable
Output	XGF-RD4A_CH3_ALMEN	BIT	0.7	Temperature input module Channel 3 alarm(PVA/RCA) enable/disable

(21) XGF-RD4S

1) U Device

Input/Output	Variable	Type	Device	Comment
Input	XGF-RD4S_CH0_ADJERR	BIT	Uxy.00.0	Isolated temperature input module: Channel 0 offset/Gain error flag
Input	XGF-RD4S_CH1_ADJERR	BIT	Uxy.00.1	Isolated temperature input module: Channel 1 offset/Gain error flag
Input	XGF-RD4S_CH2_ADJERR	BIT	Uxy.00.2	Isolated temperature input module: Channel 2 offset/Gain error flag
Input	XGF-RD4S_CH3_ADJERR	BIT	Uxy.00.3	Isolated temperature input module: Channel 3 offset/Gain error flag
Input	XGF-RD4S_EEPROMERR	BIT	Uxy.00.D	Isolated temperature input module: Offset/Gain backup error flag
Input	XGF-RD4S_WDT_ERR	BIT	Uxy.00.E	Isolated temperature input module: H/W Error Flag
Input	XGF-RD4S_RDY	BIT	Uxy.00.F	Isolated temperature input module: Module ready
Input	XGF-RD4S_CH0_ACT	BIT	Uxy.01.0	Isolated temperature input module: CH0 RUN
Input	XGF-RD4S_CH1_ACT	BIT	Uxy.01.1	Isolated temperature input module: CH1 RUN
Input	XGF-RD4S_CH2_ACT	BIT	Uxy.01.2	Isolated temperature input module: CH2 RUN
Input	XGF-RD4S_CH3_ACT	BIT	Uxy.01.3	Isolated temperature input module: CH3 RUN
Input	XGF-RD4S_CH0_BOUT	BIT	Uxy.01.4	Isolated temperature input module: Channel 0 disconnection flag
Input	XGF-RD4S_CH1_BOUT	BIT	Uxy.01.5	Isolated temperature input module: Channel 1 disconnection flag
Input	XGF-RD4S_CH2_BOUT	BIT	Uxy.01.6	Isolated temperature input module: Channel 2 disconnection flag
Input	XGF-RD4S_CH3_BOUT	BIT	Uxy.01.7	Isolated temperature input module: Channel 3 disconnection flag
Input	XGF-RD4S_CH0_SETERR	BIT	Uxy.01.8	Isolated temperature input module: Channel 0 error code
Input	XGF-RD4S_CH1_SETERR	BIT	Uxy.01.9	Isolated temperature input module: Channel 1 error code
Input	XGF-RD4S_CH2_SETERR	BIT	Uxy.01.A	Isolated temperature input module: Channel 2 error code
Input	XGF-RD4S_CH3_SETERR	BIT	Uxy.01.B	Isolated temperature input module: Channel 3 error code
Input	XGF-RD4S_CH0_PALL	BIT	Uxy.02.0	Isolated temperature input module: Channel 0 process alarm ultra

				lower limit flag	
Input	XGF-RD4S_CH0_PAL	BIT	Uxy.02.1	Isolated temperature lower limit flag	input module: Channel 0 process alarm
Input	XGF-RD4S_CH0_PAH	BIT	Uxy.02.2	Isolated temperature upper limit flag	input module: Channel 0 process alarm
Input	XGF-RD4S_CH0_PAHH	BIT	Uxy.02.3	Isolated temperature upper limit flag	input module: Channel 0 process alarm ultra
Input	XGF-RD4S_CH1_PALL	BIT	Uxy.02.4	Isolated temperature lower limit flag	input module: Channel 1 process alarm ultra
Input	XGF-RD4S_CH1_PAL	BIT	Uxy.02.5	Isolated temperature lower limit flag	input module: Channel 1 process alarm
Input	XGF-RD4S_CH1_PAH	BIT	Uxy.02.6	Isolated temperature upper limit flag	input module: Channel 1 process alarm
Input	XGF-RD4S_CH1_PAHH	BIT	Uxy.02.7	Isolated temperature upper limit flag	input module: Channel 1 process alarm ultra
Input	XGF-RD4S_CH2_PALL	BIT	Uxy.02.8	Isolated temperature lower limit flag	input module: Channel 2 process alarm ultra
Input	XGF-RD4S_CH2_PAL	BIT	Uxy.02.9	Isolated temperature lower limit flag	input module: Channel 2 process alarm
Input	XGF-RD4S_CH2_PAH	BIT	Uxy.02.A	Isolated temperature upper limit flag	input module: Channel 2 process alarm
Input	XGF-RD4S_CH2_PAHH	BIT	Uxy.02.B	Isolated temperature upper limit flag	input module: Channel 2 process alarm ultra
Input	XGF-RD4S_CH3_PALL	BIT	Uxy.02.C	Isolated temperature lower limit flag	input module: Channel 3 process alarm ultra
Input	XGF-RD4S_CH3_PAL	BIT	Uxy.02.D	Isolated temperature lower limit flag	input module: Channel 3 process alarm
Input	XGF-RD4S_CH3_PAH	BIT	Uxy.02.E	Isolated temperature upper limit flag	input module: Channel 3 process alarm
Input	XGF-RD4S_CH3_PAHH	BIT	Uxy.02.F	Isolated temperature upper limit flag	input module: Channel 3 process alarm ultra
Input	XGF-RD4S_CH0_RAL	BIT	Uxy.03.0	Isolated temperature lower limit flag	input module: Channel 0 rate change alarm
Input	XGF-RD4S_CH0_RAH	BIT	Uxy.03.1	Isolated temperature upper limit flag	input module: Channel 0 rate change alarm
Input	XGF-RD4S_CH1_RAL	BIT	Uxy.03.4	Isolated temperature lower limit flag	input module: Channel 1 rate change alarm
Input	XGF-RD4S_CH1_RAH	BIT	Uxy.03.5	Isolated temperature upper limit flag	input module: Channel 1 rate change alarm
Input	XGF-RD4S_CH2_RAL	BIT	Uxy.03.8	Isolated temperature lower limit flag	input module: Channel 2 rate change alarm
Input	XGF-RD4S_CH2_RAH	BIT	Uxy.03.9	Isolated temperature upper limit flag	input module: Channel 2 rate change alarm
Input	XGF-RD4S_CH3_RAL	BIT	Uxy.03.C	Isolated temperature lower limit flag	input module: Channel 3 rate change alarm
Input	XGF-RD4S_CH3_RAH	BIT	Uxy.03.D	Isolated temperature upper limit flag	input module: Channel 3 rate change alarm
Output	XGF-RD4S_CH0_FINDEN	BIT	Uxy.29.0	Isolated temperature enable/disable	input module: Channel 0 Max./Min. search

Appendix

Output	XGF-RD4S_CH1_FINDEN	BIT	Uxy.29.1	Isolated temperature enable/disable	input module: Channel 1 Max./Min. search
Output	XGF-RD4S_CH2_FINDEN	BIT	Uxy.29.2	Isolated temperature enable/disable	input module: Channel 2 Max./Min. search
Output	XGF-RD4S_CH3_FINDEN	BIT	Uxy.29.3	Isolated temperature enable/disable	input module: Channel 3 Max./Min. search
Output	XGF-RD4S_CH0_ALMEN	BIT	Uxy.29.4	Isolated temperature enable/disable	input module: Channel 0 alarm(PVA/RCA)
Output	XGF-RD4S_CH1_ALMEN	BIT	Uxy.29.5	Isolated temperature enable/disable	input module: Channel 1 alarm(PVA/RCA)
Output	XGF-RD4S_CH2_ALMEN	BIT	Uxy.29.6	Isolated temperature enable/disable	input module: Channel 2 alarm(PVA/RCA)
Output	XGF-RD4S_CH3_ALMEN	BIT	Uxy.29.7	Isolated temperature enable/disable	input module: Channel 3 alarm(PVA/RCA)
Input	XGF-RD4S_CH0_TEMP	Word	Uxy.04	Isolated temperature	input module: Channel 0 temperature data
Input	XGF-RD4S_CH1_TEMP	Word	Uxy.05	Isolated temperature	input module: Channel 1 temperature data
Input	XGF-RD4S_CH2_TEMP	Word	Uxy.06	Isolated temperature	input module: Channel 2 temperature data
Input	XGF-RD4S_CH3_TEMP	Word	Uxy.07	Isolated temperature	input module: Channel 3 temperature data
Input	XGF-RD4S_CH0_SCAL	Word	Uxy.08	Isolated temperature	input module: Channel 0 scaling data
Input	XGF-RD4S_CH1_SCAL	Word	Uxy.09	Isolated temperature	input module: Channel 1 scaling data
Input	XGF-RD4S_CH2_SCAL	Word	Uxy.10	Isolated temperature	input module: Channel 2 scaling data
Input	XGF-RD4S_CH3_SCAL	Word	Uxy.11	Isolated temperature	input module: Channel 3 scaling data
Input	XGF-RD4S_CH0_MIN	Word	Uxy.12	Isolated temperature data	input module: Channel 0 temperature Min. data
Input	XGF-RD4S_CH0_MAX	Word	Uxy.13	Isolated temperature data	input module: Channel 0 temperature Max. data
Input	XGF-RD4S_CH1_MIN	Word	Uxy.14	Isolated temperature data	input module: Channel 1 temperature Min. data
Input	XGF-RD4S_CH1_MAX	Word	Uxy.15	Isolated temperature data	input module: Channel 1 temperature Max. data
Input	XGF-RD4S_CH2_MIN	Word	Uxy.16	Isolated temperature data	input module: Channel 2 temperature Min. data
Input	XGF-RD4S_CH2_MAX	Word	Uxy.17	Isolated temperature data	input module: Channel 2 temperature Max. data
Input	XGF-RD4S_CH3_MIN	Word	Uxy.18	Isolated temperature data	input module: Channel 3 temperature Min. data
Input	XGF-RD4S_CH3_MAX	Word	Uxy.19	Isolated temperature data	input module: Channel 3 temperature Max. data
Input	XGF-RD4S_CH0_TIMEL	Word	Uxy.20	Isolated temperature	input module: Channel 0 data upload time
Input	XGF-RD4S_CH0_TIMEH	Word	Uxy.21	Isolated temperature	input module: Channel 0 data upload time
Input	XGF-RD4S_CH1_TIMEL	Word	Uxy.22	Isolated temperature	input module: Channel 1 data upload time
Input	XGF-RD4S_CH1_TIMEH	Word	Uxy.23	Isolated temperature	input module: Channel 1 data upload time
Input	XGF-RD4S_CH2_TIMEL	Word	Uxy.24	Isolated temperature	input module: Channel 2 data upload time
Input	XGF-RD4S_CH2_TIMEH	Word	Uxy.25	Isolated temperature	input module: Channel 2 data upload time
Input	XGF-RD4S_CH3_TIMEL	Word	Uxy.26	Isolated temperature	input module: Channel 3 data upload time
Input	XGF-RD4S_CH3_TIMEH	Word	Uxy.27	Isolated temperature	input module: Channel 3 data upload time

2) Refresh data

<Input>

Input/Output	Variable	Type	Word(16BIT) Offset	Comment
Input	XGF-RD4S_CH0_ADJERR	BIT	0.0	Isolated temperature input module: Channel 0 offset/Gain error flag
Input	XGF-RD4S_CH1_ADJERR	BIT	0.1	Isolated temperature input module: Channel 1 offset/Gain error flag
Input	XGF-RD4S_CH2_ADJERR	BIT	0.2	Isolated temperature input module: Channel 2 offset/Gain error flag
Input	XGF-RD4S_CH3_ADJERR	BIT	0.3	Isolated temperature input module: Channel 3 offset/Gain error flag
Input	XGF-RD4S_EEPROMERR	BIT	0.D	Isolated temperature input module: Offset/Gain backup error flag
Input	XGF-RD4S_WDT_ERR	BIT	0.E	Isolated temperature input module: H/W Error Flag
Input	XGF-RD4S_RDY	BIT	0.F	Isolated temperature input module: Module ready
Input	XGF-RD4S_CH0_ACT	BIT	1.0	Isolated temperature input module: CH0 RUN
Input	XGF-RD4S_CH1_ACT	BIT	1.1	Isolated temperature input module: CH1 RUN
Input	XGF-RD4S_CH2_ACT	BIT	1.2	Isolated temperature input module: CH2 RUN
Input	XGF-RD4S_CH3_ACT	BIT	1.3	Isolated temperature input module: CH3 RUN
Input	XGF-RD4S_CH0_BOUT	BIT	1.4	Isolated temperature input module: Channel 0 disconnection flag
Input	XGF-RD4S_CH1_BOUT	BIT	1.5	Isolated temperature input module: Channel 1 disconnection flag
Input	XGF-RD4S_CH2_BOUT	BIT	1.6	Isolated temperature input module: Channel 2 disconnection flag
Input	XGF-RD4S_CH3_BOUT	BIT	1.7	Isolated temperature input module: Channel 3 disconnection flag
Input	XGF-RD4S_CH0_SETERR	BIT	1.8	Isolated temperature input module: Channel 0 error code
Input	XGF-RD4S_CH1_SETERR	BIT	1.9	Isolated temperature input module: Channel 1 error code
Input	XGF-RD4S_CH2_SETERR	BIT	1.A	Isolated temperature input module: Channel 2 error code
Input	XGF-RD4S_CH3_SETERR	BIT	1.B	Isolated temperature input module: Channel 3 error code
Input	XGF-RD4S_CH0_PALL	BIT	2.0	Isolated temperature input module: Channel 0 process alarm ultra lower limit flag
Input	XGF-RD4S_CH0_PAL	BIT	2.1	Isolated temperature input module: Channel 0 process alarm lower limit flag
Input	XGF-RD4S_CH0_PAH	BIT	2.2	Isolated temperature input module: Channel 0 process alarm upper limit flag
Input	XGF-RD4S_CH0_PAHH	BIT	2.3	Isolated temperature input module: Channel 0 process alarm ultra upper limit flag
Input	XGF-RD4S_CH1_PALL	BIT	2.4	Isolated temperature input module: Channel 1 process alarm ultra lower limit flag
Input	XGF-RD4S_CH1_PAL	BIT	2.5	Isolated temperature input module: Channel 1 process alarm lower limit flag
Input	XGF-RD4S_CH1_PAH	BIT	2.6	Isolated temperature input module: Channel 1 process alarm upper limit flag

Appendix

Input	XGF-RD4S_CH1_PAHH	BIT	2.7	Isolated temperature upper limit flag	input module: Channel 1 process alarm ultra
Input	XGF-RD4S_CH2_PALL	BIT	2.8	Isolated temperature lower limit flag	input module: Channel 2 process alarm ultra
Input	XGF-RD4S_CH2_PAL	BIT	2.9	Isolated temperature flag	input module: Channel 2 process alarm lower limit
Input	XGF-RD4S_CH2_PAH	BIT	2.A	Isolated temperature limit flag	input module: Channel 2 process alarm upper
Input	XGF-RD4S_CH2_PAHH	BIT	2.B	Isolated temperature upper limit flag	input module: Channel 2 process alarm ultra
Input	XGF-RD4S_CH3_PALL	BIT	2.C	Isolated temperature lower limit flag	input module: Channel 3 process alarm ultra
Input	XGF-RD4S_CH3_PAL	BIT	2.D	Isolated temperature flag	input module: Channel 3 process alarm lower limit
Input	XGF-RD4S_CH3_PAH	BIT	2.E	Isolated temperature limit flag	input module: Channel 3 process alarm upper
Input	XGF-RD4S_CH3_PAHH	BIT	2.F	Isolated temperature upper limit flag	input module: Channel 3 process alarm ultra
Input	XGF-RD4S_CH0_RAL	BIT	3.0	Isolated temperature limit flag	input module: Channel 0 rate change alarm lower
Input	XGF-RD4S_CH0_RAH	BIT	3.1	Isolated temperature limit flag	input module: Channel 0 rate change alarm upper
Input	XGF-RD4S_CH1_RAL	BIT	3.4	Isolated temperature limit flag	input module: Channel 1 rate change alarm lower
Input	XGF-RD4S_CH1_RAH	BIT	3.5	Isolated temperature limit flag	input module: Channel 1 rate change alarm upper
Input	XGF-RD4S_CH2_RAL	BIT	3.8	Isolated temperature limit flag	input module: Channel 2 rate change alarm lower
Input	XGF-RD4S_CH2_RAH	BIT	3.9	Isolated temperature limit flag	input module: Channel 2 rate change alarm upper
Input	XGF-RD4S_CH3_RAL	BIT	3.C	Isolated temperature limit flag	input module: Channel 3 rate change alarm lower
Input	XGF-RD4S_CH3_RAH	BIT	3.D	Isolated temperature limit flag	input module: Channel 3 rate change alarm upper
Input	XGF-RD4S_CH0_TEMP	Word	4	Isolated temperature	input module: Channel 0 temperature data
Input	XGF-RD4S_CH1_TEMP	Word	5	Isolated temperature	input module: Channel 1 temperature data
Input	XGF-RD4S_CH2_TEMP	Word	6	Isolated temperature	input module: Channel 2 temperature data
Input	XGF-RD4S_CH3_TEMP	Word	7	Isolated temperature	input module: Channel 3 temperature data
Input	XGF-RD4S_CH0_SCAL	Word	8	Isolated temperature	input module: Channel 0 scaling data
Input	XGF-RD4S_CH1_SCAL	Word	9	Isolated temperature	input module: Channel 1 scaling data
Input	XGF-RD4S_CH2_SCAL	Word	10	Isolated temperature	input module: Channel 2 scaling data
Input	XGF-	Word	11	Isolated temperature	input module: Channel 3 scaling data

	RD4S_CH3_SCAL			
Input	XGF-RD4S_CH0_MIN	Word	12	Isolated temperature input module: Channel 0 temperature Min. data
Input	XGF-RD4S_CH0_MAX	Word	13	Isolated temperature input module: Channel 0 temperature Max. data
Input	XGF-RD4S_CH1_MIN	Word	14	Isolated temperature input module: Channel 1 temperature Min. data
Input	XGF-RD4S_CH1_MAX	Word	15	Isolated temperature input module: Channel 1 temperature Max. data
Input	XGF-RD4S_CH2_MIN	Word	16	Isolated temperature input module: Channel 2 temperature Min. data
Input	XGF-RD4S_CH2_MAX	Word	17	Isolated temperature input module: Channel 2 temperature Max. data
Input	XGF-RD4S_CH3_MIN	Word	18	Isolated temperature input module: Channel 3 temperature Min. data
Input	XGF-RD4S_CH3_MAX	Word	19	Isolated temperature input module: Channel 3 temperature Max. data
Input	XGF-RD4S_CH0_TIMEL	Word	20	Isolated temperature input module: Channel 0 data upload time
Input	XGF-RD4S_CH0_TIMEH	Word	21	Isolated temperature input module: Channel 0 data upload time
Input	XGF-RD4S_CH1_TIMEL	Word	22	Isolated temperature input module: Channel 1 data upload time
Input	XGF-RD4S_CH1_TIMEH	Word	23	Isolated temperature input module: Channel 1 data upload time
Input	XGF-RD4S_CH2_TIMEL	Word	24	Isolated temperature input module: Channel 2 data upload time
Input	XGF-RD4S_CH2_TIMEH	Word	25	Isolated temperature input module: Channel 2 data upload time
Input	XGF-RD4S_CH3_TIMEL	Word	26	Isolated temperature input module: Channel 3 data upload time
Input	XGF-RD4S_CH3_TIMEH	Word	27	Isolated temperature input module: Channel 3 data upload time
Input		WORD	28	Reserved

<Output>

Input/Output	Variable	Type	Word(16BIT) Offset	Comment
Output	XGF-RD4S_CH0_FINDEN	BIT	0.0	Isolated temperature input module: Channel 0 Max./Min. search enable/disable
Output	XGF-RD4S_CH1_FINDEN	BIT	0.1	Isolated temperature input module: Channel 1 Max./Min. search enable/disable
Output	XGF-RD4S_CH2_FINDEN	BIT	0.2	Isolated temperature input module: Channel 2 Max./Min. search enable/disable
Output	XGF-RD4S_CH3_FINDEN	BIT	0.3	Isolated temperature input module: Channel 3 Max./Min. search enable/disable
Output	XGF-RD4S_CH0_ALMEN	BIT	0.4	Isolated temperature input module: Channel 0 alarm(PVA/RCA) enable/disable
Output	XGF-RD4S_CH1_ALMEN	BIT	0.5	Isolated temperature input module: Channel 1 alarm(PVA/RCA) enable/disable
Output	XGF-RD4S_CH2_ALMEN	BIT	0.6	Isolated temperature input module: Channel 2 alarm(PVA/RCA) enable/disable
Output	XGF-RD4S_CH3_ALMEN	BIT	0.7	Isolated temperature input module: Channel 3 alarm(PVA/RCA) enable/disable

(22) XGF-TC4S

1) U Device

Input/Output	Variable	Type	Device	Comment
Input	XGF-TC4S_CH0_ADJERR	BIT	Uxy.00.0	Isolated temperature input module: Channel 0 offset/Gain error flag
Input	XGF-TC4S_CH1_ADJERR	BIT	Uxy.00.1	Isolated temperature input module: Channel 1 offset/Gain error flag
Input	XGF-TC4S_CH2_ADJERR	BIT	Uxy.00.2	Isolated temperature input module: Channel 2 offset/Gain error flag
Input	XGF-TC4S_CH3_ADJERR	BIT	Uxy.00.3	Isolated temperature input module: Channel 3 offset/Gain error flag
Input	XGF-TC4S_EEPROMERR	BIT	Uxy.00.D	Isolated temperature input module: Offset/Gain backup error flag
Input	XGF-TC4S_WDT_ERR	BIT	Uxy.00.E	Isolated temperature input module: H/W Error Flag
Input	XGF-TC4S_RDY	BIT	Uxy.00.F	Isolated temperature input module: Module ready
Input	XGF-TC4S_CH0_ACT	BIT	Uxy.01.0	Isolated temperature input module: CH0 RUN
Input	XGF-TC4S_CH1_ACT	BIT	Uxy.01.1	Isolated temperature input module: CH1 RUN
Input	XGF-TC4S_CH2_ACT	BIT	Uxy.01.2	Isolated temperature input module: CH2 RUN
Input	XGF-TC4S_CH3_ACT	BIT	Uxy.01.3	Isolated temperature input module: CH3 RUN
Input	XGF-TC4S_CH0_BOUT	BIT	Uxy.01.4	Isolated temperature input module: Channel 0 disconnection flag
Input	XGF-TC4S_CH1_BOUT	BIT	Uxy.01.5	Isolated temperature input module: Channel 1 disconnection flag
Input	XGF-TC4S_CH2_BOUT	BIT	Uxy.01.6	Isolated temperature input module: Channel 2 disconnection flag
Input	XGF-TC4S_CH3_BOUT	BIT	Uxy.01.7	Isolated temperature input module: Channel 3 disconnection flag
Input	XGF-TC4S_CH0_SETERR	BIT	Uxy.01.8	Isolated temperature input module: Channel 0 error code
Input	XGF-TC4S_CH1_SETERR	BIT	Uxy.01.9	Isolated temperature input module: Channel 1 error code
Input	XGF-TC4S_CH2_SETERR	BIT	Uxy.01.A	Isolated temperature input module: Channel 2 error code
Input	XGF-TC4S_CH3_SETERR	BIT	Uxy.01.B	Isolated temperature input module: Channel 3 error code
Input	XGF-TC4S_CH0_PALL	BIT	Uxy.02.0	Isolated temperature input module: Channel 0 process alarm ultra lower limit flag
Input	XGF-TC4S_CH0_PAL	BIT	Uxy.02.1	Isolated temperature input module: Channel 0 process alarm lower limit flag
Input	XGF-TC4S_CH0_PAH	BIT	Uxy.02.2	Isolated temperature input module: Channel 0 process alarm upper limit flag
Input	XGF-TC4S_CH0_PAHH	BIT	Uxy.02.3	Isolated temperature input module: Channel 0 process alarm ultra upper limit flag
Input	XGF-TC4S_CH1_PALL	BIT	Uxy.02.4	Isolated temperature input module: Channel 1 process alarm ultra lower limit flag
Input	XGF-TC4S_CH1_PAL	BIT	Uxy.02.5	Isolated temperature input module: Channel 1 process alarm lower limit flag
Input	XGF-TC4S_CH1_PAH	BIT	Uxy.02.6	Isolated temperature input module: Channel 1 process alarm upper limit flag
Input	XGF-TC4S_CH1_PAHH	BIT	Uxy.02.7	Isolated temperature input module: Channel 1 process alarm ultra upper limit flag
Input	XGF-TC4S_CH2_PALL	BIT	Uxy.02.8	Isolated temperature input module: Channel 2 process alarm ultra lower limit flag
Input	XGF-TC4S_CH2_PAL	BIT	Uxy.02.9	Isolated temperature input module: Channel 2 process alarm

				lower limit flag
Input	XGF-TC4S_CH2_PAH	BIT	Uxy.02.A	Isolated temperature input module: Channel 2 process alarm upper limit flag
Input	XGF-TC4S_CH2_PAHH	BIT	Uxy.02.B	Isolated temperature input module: Channel 2 process alarm ultra upper limit flag
Input	XGF-TC4S_CH3_PALL	BIT	Uxy.02.C	Isolated temperature input module: Channel 3 process alarm ultra lower limit flag
Input	XGF-TC4S_CH3_PAL	BIT	Uxy.02.D	Isolated temperature input module: Channel 3 process alarm lower limit flag
Input	XGF-TC4S_CH3_PAH	BIT	Uxy.02.E	Isolated temperature input module: Channel 3 process alarm upper limit flag
Input	XGF-TC4S_CH3_PAHH	BIT	Uxy.02.F	Isolated temperature input module: Channel 3 process alarm ultra upper limit flag
Input	XGF-TC4S_CH0_RAL	BIT	Uxy.03.0	Isolated temperature input module: Channel 0 rate change alarm lower limit flag
Input	XGF-TC4S_CH0_RAH	BIT	Uxy.03.1	Isolated temperature input module: Channel 0 rate change alarm upper limit flag
Input	XGF-TC4S_CH1_RAL	BIT	Uxy.03.4	Isolated temperature input module: Channel 1 rate change alarm lower limit flag
Input	XGF-TC4S_CH1_RAH	BIT	Uxy.03.5	Isolated temperature input module: Channel 1 rate change alarm upper limit flag
Input	XGF-TC4S_CH2_RAL	BIT	Uxy.03.8	Isolated temperature input module: Channel 2 rate change alarm lower limit flag
Input	XGF-TC4S_CH2_RAH	BIT	Uxy.03.9	Isolated temperature input module: Channel 2 rate change alarm upper limit flag
Input	XGF-TC4S_CH3_RAL	BIT	Uxy.03.C	Isolated temperature input module: Channel 3 rate change alarm lower limit flag
Input	XGF-TC4S_CH3_RAH	BIT	Uxy.03.D	Isolated temperature input module: Channel 3 rate change alarm upper limit flag
Output	XGF-TC4S_CH0_FINDEN	BIT	Uxy.29.0	Isolated temperature input module: Channel 0 Max./Min. search enable/disable
Output	XGF-TC4S_CH1_FINDEN	BIT	Uxy.29.1	Isolated temperature input module: Channel 1 Max./Min. search enable/disable
Output	XGF-TC4S_CH2_FINDEN	BIT	Uxy.29.2	Isolated temperature input module: Channel 2 Max./Min. search enable/disable
Output	XGF-TC4S_CH3_FINDEN	BIT	Uxy.29.3	Isolated temperature input module: Channel 3 Max./Min. search enable/disable
Output	XGF-TC4S_CH0_ALMEN	BIT	Uxy.29.4	Isolated temperature input module: Channel 0 alarm(PVA/RCA) enable/disable
Output	XGF-TC4S_CH1_ALMEN	BIT	Uxy.29.5	Isolated temperature input module: Channel 1 alarm(PVA/RCA) enable/disable
Output	XGF-TC4S_CH2_ALMEN	BIT	Uxy.29.6	Isolated temperature input module: Channel 2 alarm(PVA/RCA) enable/disable
Output	XGF-TC4S_CH3_ALMEN	BIT	Uxy.29.7	Isolated temperature input module: Channel 3 alarm(PVA/RCA) enable/disable
Output	XGF-TC4S_CH0_RJCDS	BIT	Uxy.29.8	Isolated temperature input module: Channel 0 cold junction compensation enable/disable
Output	XGF-TC4S_CH1_RJCDS	BIT	Uxy.29.9	Isolated temperature input module: Channel 1 cold junction compensation enable/disable

Appendix

Output	XGF-TC4S_CH2_RJCDS	BIT	Uxy.29.A	Isolated temperature input module: Channel 2 cold junction compensation enable/disable
Output	XGF-TC4S_CH3_RJCDS	BIT	Uxy.29.B	Isolated temperature input module: Channel 3 cold junction compensation enable/disable
Input	XGF-TC4S_CH0_TEMP	Word	Uxy.04	Isolated temperature input module: Channel 0 temperature data
Input	XGF-TC4S_CH1_TEMP	Word	Uxy.05	Isolated temperature input module: Channel 1 temperature data
Input	XGF-TC4S_CH2_TEMP	Word	Uxy.06	Isolated temperature input module: Channel 2 temperature data
Input	XGF-TC4S_CH3_TEMP	Word	Uxy.07	Isolated temperature input module: Channel 3 temperature data
Input	XGF-TC4S_CH0_SCAL	Word	Uxy.08	Isolated temperature input module: Channel 0 scaling data
Input	XGF-TC4S_CH1_SCAL	Word	Uxy.09	Isolated temperature input module: Channel 1 scaling data
Input	XGF-TC4S_CH2_SCAL	Word	Uxy.10	Isolated temperature input module: Channel 2 scaling data
Input	XGF-TC4S_CH3_SCAL	Word	Uxy.11	Isolated temperature input module: Channel 3 scaling data
Input	XGF-TC4S_CH0_MIN	Word	Uxy.12	Isolated temperature input module: Channel 0 temperature Min. data
Input	XGF-TC4S_CH0_MAX	Word	Uxy.13	Isolated temperature input module: Channel 0 temperature Max. data
Input	XGF-TC4S_CH1_MIN	Word	Uxy.14	Isolated temperature input module: Channel 1 temperature Min. data
Input	XGF-TC4S_CH1_MAX	Word	Uxy.15	Isolated temperature input module: Channel 1 temperature Max. data
Input	XGF-TC4S_CH2_MIN	Word	Uxy.16	Isolated temperature input module: Channel 2 temperature Min. data
Input	XGF-TC4S_CH2_MAX	Word	Uxy.17	Isolated temperature input module: Channel 2 temperature Max. data
Input	XGF-TC4S_CH3_MIN	Word	Uxy.18	Isolated temperature input module: Channel 3 temperature Min. data
Input	XGF-TC4S_CH3_MAX	Word	Uxy.19	Isolated temperature input module: Channel 3 temperature Max. data
Input	XGF-TC4S_CH0_TIMEL	Word	Uxy.20	Isolated temperature input module: Channel 0 data upload time
Input	XGF-TC4S_CH0_TIMEH	Word	Uxy.21	Isolated temperature input module: Channel 0 data upload time
Input	XGF-TC4S_CH1_TIMEL	Word	Uxy.22	Isolated temperature input module: Channel 1 data upload time
Input	XGF-TC4S_CH1_TIMEH	Word	Uxy.23	Isolated temperature input module: Channel 1 data upload time
Input	XGF-TC4S_CH2_TIMEL	Word	Uxy.24	Isolated temperature input module: Channel 2 data upload time
Input	XGF-TC4S_CH2_TIMEH	Word	Uxy.25	Isolated temperature input module: Channel 2 data upload time
Input	XGF-TC4S_CH3_TIMEL	Word	Uxy.26	Isolated temperature input module: Channel 3 data upload time
Input	XGF-TC4S_CH3_TIMEH	Word	Uxy.27	Isolated temperature input module: Channel 3 data upload time

2) Refresh data

<Input>

Input/Output	Variable	Type	Word(16BIT) Offset	Comment
Input	XGF-TC4S_CH0_ADJERR	BIT	0.0	Isolated temperature input module: Channel 0 offset/Gain error flag
Input	XGF-TC4S_CH1_ADJERR	BIT	0.1	Isolated temperature input module: Channel 1 offset/Gain error flag
Input	XGF-TC4S_CH2_ADJERR	BIT	0.2	Isolated temperature input module: Channel 2 offset/Gain error flag

Input	XGF-TC4S_CH3_ADJERR	BIT	0.3	Isolated temperature	input module: Channel 3 offset/Gain error flag
Input	XGF-TC4S_EEPROMERR	BIT	0.D	Isolated temperature	input module: Offset/Gain backup error flag
Input	XGF-TC4S_WDT_ERR	BIT	0.E	Isolated temperature	input module: H/W Error Flag
Input	XGF-TC4S_RDY	BIT	0.F	Isolated temperature	input module: Module ready
Input	XGF-TC4S_CH0_ACT	BIT	1.0	Isolated temperature	input module: CH0 RUN
Input	XGF-TC4S_CH1_ACT	BIT	1.1	Isolated temperature	input module: CH1 RUN
Input	XGF-TC4S_CH2_ACT	BIT	1.2	Isolated temperature	input module: CH2 RUN
Input	XGF-TC4S_CH3_ACT	BIT	1.3	Isolated temperature	input module: CH3 RUN
Input	XGF-TC4S_CH0_BOUT	BIT	1.4	Isolated temperature	input module: Channel 0 disconnection flag
Input	XGF-TC4S_CH1_BOUT	BIT	1.5	Isolated temperature	input module: Channel 1 disconnection flag
Input	XGF-TC4S_CH2_BOUT	BIT	1.6	Isolated temperature	input module: Channel 2 disconnection flag
Input	XGF-TC4S_CH3_BOUT	BIT	1.7	Isolated temperature	input module: Channel 3 disconnection flag
Input	XGF-TC4S_CH0_SETERR	BIT	1.8	Isolated temperature	input module: Channel 0 error code
Input	XGF-TC4S_CH1_SETERR	BIT	1.9	Isolated temperature	input module: Channel 1 error code
Input	XGF-TC4S_CH2_SETERR	BIT	1.A	Isolated temperature	input module: Channel 2 error code
Input	XGF-TC4S_CH3_SETERR	BIT	1.B	Isolated temperature	input module: Channel 3 error code
Input	XGF-TC4S_CH0_PALL	BIT	2.0	Isolated temperature	input module: Channel 0 process alarm ultra lower limit flag
Input	XGF-TC4S_CH0_PAL	BIT	2.1	Isolated temperature	input module: Channel 0 process alarm lower limit flag
Input	XGF-TC4S_CH0_PAH	BIT	2.2	Isolated temperature	input module: Channel 0 process alarm upper limit flag
Input	XGF-TC4S_CH0_PAHH	BIT	2.3	Isolated temperature	input module: Channel 0 process alarm ultra upper limit flag
Input	XGF-TC4S_CH1_PALL	BIT	2.4	Isolated temperature	input module: Channel 1 process alarm ultra lower limit flag
Input	XGF-TC4S_CH1_PAL	BIT	2.5	Isolated temperature	input module: Channel 1 process alarm lower limit flag
Input	XGF-TC4S_CH1_PAH	BIT	2.6	Isolated temperature	input module: Channel 1 process alarm upper limit flag
Input	XGF-TC4S_CH1_PAHH	BIT	2.7	Isolated temperature	input module: Channel 1 process alarm ultra upper limit flag
Input	XGF-TC4S_CH2_PALL	BIT	2.8	Isolated temperature	input module: Channel 2 process alarm ultra lower limit flag
Input	XGF-TC4S_CH2_PAL	BIT	2.9	Isolated temperature	input module: Channel 2 process alarm lower limit flag
Input	XGF-TC4S_CH2_PAH	BIT	2.A	Isolated temperature	input module: Channel 2 process alarm upper limit flag
Input	XGF-	BIT	2.B	Isolated temperature	input module: Channel 2 process alarm ultra

Appendix

	TC4S_CH2_PAHH			upper limit flag	
Input	XGF-TC4S_CH3_PALL	BIT	2.C	Isolated temperature limit flag	input module: Channel 3 process alarm ultra lower limit flag
Input	XGF-TC4S_CH3_PAL	BIT	2.D	Isolated temperature flag	input module: Channel 3 process alarm lower limit flag
Input	XGF-TC4S_CH3_PAH	BIT	2.E	Isolated temperature flag	input module: Channel 3 process alarm upper limit flag
Input	XGF-TC4S_CH3_PAHH	BIT	2.F	Isolated temperature upper limit flag	input module: Channel 3 process alarm ultra upper limit flag
Input	XGF-TC4S_CH0_RAL	BIT	3.0	Isolated temperature limit flag	input module: Channel 0 rate change alarm lower limit flag
Input	XGF-TC4S_CH0_RAH	BIT	3.1	Isolated temperature limit flag	input module: Channel 0 rate change alarm upper limit flag
Input	XGF-TC4S_CH1_RAL	BIT	3.4	Isolated temperature limit flag	input module: Channel 1 rate change alarm lower limit flag
Input	XGF-TC4S_CH1_RAH	BIT	3.5	Isolated temperature limit flag	input module: Channel 1 rate change alarm upper limit flag
Input	XGF-TC4S_CH2_RAL	BIT	3.8	Isolated temperature limit flag	input module: Channel 2 rate change alarm lower limit flag
Input	XGF-TC4S_CH2_RAH	BIT	3.9	Isolated temperature limit flag	input module: Channel 2 rate change alarm upper limit flag
Input	XGF-TC4S_CH3_RAL	BIT	3.C	Isolated temperature limit flag	input module: Channel 3 rate change alarm lower limit flag
Input	XGF-TC4S_CH3_RAH	BIT	3.D	Isolated temperature limit flag	input module: Channel 3 rate change alarm upper limit flag
Input	XGF-TC4S_CH0_TEMP	Word	4	Isolated temperature	input module: Channel 0 temperature data
Input	XGF-TC4S_CH1_TEMP	Word	5	Isolated temperature	input module: Channel 1 temperature data
Input	XGF-TC4S_CH2_TEMP	Word	6	Isolated temperature	input module: Channel 2 temperature data
Input	XGF-TC4S_CH3_TEMP	Word	7	Isolated temperature	input module: Channel 3 temperature data
Input	XGF-TC4S_CH0_SCAL	Word	8	Isolated temperature	input module: Channel 0 scaling data
Input	XGF-TC4S_CH1_SCAL	Word	9	Isolated temperature	input module: Channel 1 scaling data
Input	XGF-TC4S_CH2_SCAL	Word	10	Isolated temperature	input module: Channel 2 scaling data
Input	XGF-TC4S_CH3_SCAL	Word	11	Isolated temperature	input module: Channel 3 scaling data
Input	XGF-TC4S_CH0_MIN	Word	12	Isolated temperature	input module: Channel 0 temperature Min. data
Input	XGF-TC4S_CH0_MAX	Word	13	Isolated temperature	input module: Channel 0 temperature Max. data
Input	XGF-TC4S_CH1_MIN	Word	14	Isolated temperature	input module: Channel 1 temperature Min. data
Input	XGF-TC4S_CH1_MAX	Word	15	Isolated temperature	input module: Channel 1 temperature Max. data
Input	XGF-TC4S_CH2_MIN	Word	16	Isolated temperature	input module: Channel 2 temperature Min. data
Input	XGF-TC4S_CH2_MAX	Word	17	Isolated temperature	input module: Channel 2 temperature Max. data
Input	XGF-TC4S_CH3_MIN	Word	18	Isolated temperature	input module: Channel 3 temperature Min. data
Input	XGF-TC4S_CH3_MAX	Word	19	Isolated temperature	input module: Channel 3 temperature Max. data

Input	XGF-TC4S_CH0_TIMEL	Word	20	Isolated temperature input module: Channel 0 data upload time
Input	XGF-TC4S_CH0_TIMEH	Word	21	Isolated temperature input module: Channel 0 data upload time
Input	XGF-TC4S_CH1_TIMEL	Word	22	Isolated temperature input module: Channel 1 data upload time
Input	XGF-TC4S_CH1_TIMEH	Word	23	Isolated temperature input module: Channel 1 data upload time
Input	XGF-TC4S_CH2_TIMEL	Word	24	Isolated temperature input module: Channel 2 data upload time
Input	XGF-TC4S_CH2_TIMEH	Word	25	Isolated temperature input module: Channel 2 data upload time
Input	XGF-TC4S_CH3_TIMEL	Word	26	Isolated temperature input module: Channel 3 data upload time
Input	XGF-TC4S_CH3_TIMEH	Word	27	Isolated temperature input module: Channel 3 data upload time
Input		Word	28	Reserved

<Output>

Input/Output	Variable	Type	Word(16BIT) Offset	Comment
Output	XGF-TC4S_CH0_FINDEN	BIT	0.0	Isolated temperature input module: Channel 0 Max./Min. search enable/disable
Output	XGF-TC4S_CH1_FINDEN	BIT	0.1	Isolated temperature input module: Channel 1 Max./Min. search enable/disable
Output	XGF-TC4S_CH2_FINDEN	BIT	0.2	Isolated temperature input module: Channel 2 Max./Min. search enable/disable
Output	XGF-TC4S_CH3_FINDEN	BIT	0.3	Isolated temperature input module: Channel 3 Max./Min. search enable/disable
Output	XGF-TC4S_CH0_ALMEN	BIT	0.4	Isolated temperature input module: Channel 0 alarm(PVA/RCA) enable/disable
Output	XGF-TC4S_CH1_ALMEN	BIT	0.5	Isolated temperature input module: Channel 1 alarm(PVA/RCA) enable/disable
Output	XGF-TC4S_CH2_ALMEN	BIT	0.6	Isolated temperature input module: Channel 2 alarm(PVA/RCA) enable/disable
Output	XGF-TC4S_CH3_ALMEN	BIT	0.7	Isolated temperature input module: Channel 3 alarm(PVA/RCA) enable/disable
Output	XGF-TC4S_CH0_RJCDS	BIT	0.8	Isolated temperature input module: Channel 0 cold junction compensation enable/disable
Output	XGF-TC4S_CH1_RJCDS	BIT	0.9	Isolated temperature input module: Channel 1 cold junction compensation enable/disable
Output	XGF-TC4S_CH2_RJCDS	BIT	0.A	Isolated temperature input module: Channel 2 cold junction compensation enable/disable
Output	XGF-TC4S_CH3_RJCDS	BIT	0.B	Isolated temperature input module: Channel 3 cold junction compensation enable/disable

(23) XGF-TC4UD

1) U Device

Input/Output	Variable	Type	Device	Comment
--------------	----------	------	--------	---------

Appendix

t				
Input	XGF-TC4UD_CH0_ACT	BIT	Uxy.00.0	Temperature controller module: CH0 RUN
Input	XGF-TC4UD_CH1_ACT	BIT	Uxy.00.1	Temperature controller module: CH1 RUN
Input	XGF-TC4UD_CH2_ACT	BIT	Uxy.00.2	Temperature controller module: CH2 RUN
Input	XGF-TC4UD_CH3_ACT	BIT	Uxy.00.3	Temperature controller module: CH3 RUN
Input	XGF-TC4UD_CH0_BOUT	BIT	Uxy.00.4	Temperature controller module: Channel 0 disconnection flag
Input	XGF-TC4UD_CH1_BOUT	BIT	Uxy.00.5	Temperature controller module: Channel 1 disconnection flag
Input	XGF-TC4UD_CH2_BOUT	BIT	Uxy.00.6	Temperature controller module: Channel 2 disconnection flag
Input	XGF-TC4UD_CH3_BOUT	BIT	Uxy.00.7	Temperature controller module: Channel 3 disconnection flag
Input	XGF-TC4UD_CH0_ADCERR	BIT	Uxy.00.8	Temperature controller module: Channel 0 A/D conversion error
Input	XGF-TC4UD_CH1_ADCERR	BIT	Uxy.00.9	Temperature controller module: Channel 1 A/D conversion error
Input	XGF-TC4UD_CH2_ADCERR	BIT	Uxy.00. A	Temperature controller module: Channel 2 A/D conversion error
Input	XGF-TC4UD_CH3_ADCERR	BIT	Uxy.00. B	Temperature controller module: Channel 3 A/D conversion error
Input	XGF-TC4UD_CHECKSUMERR	BIT	Uxy.00. D	Temperature controller module: Module backup memory error
Input	XGF-TC4UD_ERR	BIT	Uxy.00. E	Temperature controller module: Module error
Input	XGF-TC4UD_RDY	BIT	Uxy.00.F	Temperature controller module: Module ready
Input	XGF-TC4UD_WR_ING	BIT	Uxy.01.0	Temperature controller module: Parameter writing
Input	XGF-TC4UD_RD_ING	BIT	Uxy.01.8	Temperature controller module: Parameter reading
Input	XGF-TC4UD_CH0_ALINHH	BIT	Uxy.02.0	Temperature controller module: Channel 0 input alarm HH limit
Input	XGF-TC4UD_CH0_ALINH	BIT	Uxy.02.1	Temperature controller module: Channel 0 input alarm high limit
Input	XGF-TC4UD_CH0_ALINL	BIT	Uxy.02.2	Temperature controller module: Channel 0 input alarm lower limit
Input	XGF-TC4UD_CH0_ALINLL	BIT	Uxy.02.3	Temperature controller module: Channel 0 input alarm LL limit
Input	XGF-TC4UD_CH0_ALHOH	BIT	Uxy.02.4	Temperature controller module: Channel 0 heat output alarm upper limit
Input	XGF-TC4UD_CH0_ALHOL	BIT	Uxy.02.5	Temperature controller module: Channel 0 heat output alarm lower limit
Input	XGF-TC4UD_CH0_ALCOH	BIT	Uxy.02.6	Temperature controller module: Channel 0 cooling output alarm upper limit
Input	XGF-TC4UD_CH0_ALCOL	BIT	Uxy.02.7	Temperature controller module: Channel 0 cooling output alarm lower limit
Input	XGF-TC4UD_CH1_ALINHH	BIT	Uxy.03.0	Temperature controller module: Channel 1 input alarm HH limit
Input	XGF-TC4UD_CH1_ALINH	BIT	Uxy.03.1	Temperature controller module: Channel 1 input alarm high limit
Input	XGF-TC4UD_CH1_ALINL	BIT	Uxy.03.2	Temperature controller module: Channel 1 input alarm lower limit
Input	XGF-TC4UD_CH1_ALINLL	BIT	Uxy.03.3	Temperature controller module: Channel 1 input alarm LL limit
Input	XGF-TC4UD_CH1_ALHOH	BIT	Uxy.03.4	Temperature controller module: Channel 1 heat output alarm upper limit
Input	XGF-TC4UD_CH1_ALHOL	BIT	Uxy.03.5	Temperature controller module: Channel 1 heat output alarm lower limit
Input	XGF-TC4UD_CH1_ALCOH	BIT	Uxy.03.6	Temperature controller module: Channel 1 cooling output alarm upper limit
Input	XGF-TC4UD_CH1_ALCOL	BIT	Uxy.03.7	Temperature controller module: Channel 1 cooling output alarm lower limit
Input	XGF-TC4UD_CH2_ALINHH	BIT	Uxy.04.0	Temperature controller module: Channel 2 input alarm HH limit
Input	XGF-TC4UD_CH2_ALINH	BIT	Uxy.04.1	Temperature controller module: Channel 2 input alarm high limit
Input	XGF-TC4UD_CH2_ALINL	BIT	Uxy.04.2	Temperature controller module: Channel 2 input alarm lower limit
Input	XGF-TC4UD_CH2_ALINLL	BIT	Uxy.04.3	Temperature controller module: Channel 2 input alarm LL limit
Input	XGF-TC4UD_CH2_ALHOH	BIT	Uxy.04.4	Temperature controller module: Channel 2 heat output alarm upper limit
Input	XGF-TC4UD_CH2_ALHOL	BIT	Uxy.04.5	Temperature controller module: Channel 2 heat output alarm lower limit
Input	XGF-TC4UD_CH2_ALCOH	BIT	Uxy.04.6	Temperature controller module: Channel 2 cooling output alarm upper

				limit
Input	XGF-TC4UD_CH2_ALCOL	BIT	Uxy.04.7	Temperature controller module: Channel 2 cooling output alarm lower limit
Input	XGF-TC4UD_CH3_ALINHH	BIT	Uxy.05.0	Temperature controller module: Channel 3 input alarm HH limit
Input	XGF-TC4UD_CH3_ALINH	BIT	Uxy.05.1	Temperature controller module: Channel 3 input alarm high limit
Input	XGF-TC4UD_CH3_ALINL	BIT	Uxy.05.2	Temperature controller module: Channel 3 input alarm lower limit
Input	XGF-TC4UD_CH3_ALINLL	BIT	Uxy.05.3	Temperature controller module: Channel 3 input alarm LL limit
Input	XGF-TC4UD_CH3_ALHOH	BIT	Uxy.05.4	Temperature controller module: Channel 3 heat output alarm upper limit
Input	XGF-TC4UD_CH3_ALHOL	BIT	Uxy.05.5	Temperature controller module: Channel 3 heat output alarm lower limit
Input	XGF-TC4UD_CH3_ALCOH	BIT	Uxy.05.6	Temperature controller module: Channel 3 cooling output alarm upper limit
Input	XGF-TC4UD_CH3_ALCOL	BIT	Uxy.05.7	Temperature controller module: Channel 3 cooling output alarm lower limit
Output	XGF-TC4UD_CH0_RUN	BIT	Uxy.18.0	Temperature controller module: Channel 0 run command
Output	XGF-TC4UD_CH0_MAN	BIT	Uxy.18.1	Temperature controller module: Channel 0 manual mode command
Output	XGF-TC4UD_CH0_ATEN	BIT	Uxy.18.2	Temperature controller module: Channel 0 auto-tuning command
Output	XGF-TC4UD_CH0_EXIN	BIT	Uxy.18.3	Temperature controller module: Channel 0 external input enable command
Output	XGF-TC4UD_CH1_RUN	BIT	Uxy.19.0	Temperature controller module: Channel 1 run command
Output	XGF-TC4UD_CH1_MAN	BIT	Uxy.19.1	Temperature controller module: Channel 1 manual mode command
Output	XGF-TC4UD_CH1_ATEN	BIT	Uxy.19.2	Temperature controller module: Channel 1 auto-tuning command
Output	XGF-TC4UD_CH1_EXIN	BIT	Uxy.19.3	Temperature controller module: Channel 1 external input enable command
Output	XGF-TC4UD_CH2_RUN	BIT	Uxy.20.0	Temperature controller module: Channel 2 run command
Output	XGF-TC4UD_CH2_MAN	BIT	Uxy.20.1	Temperature controller module: Channel 2 manual mode command
Output	XGF-TC4UD_CH2_ATEN	BIT	Uxy.20.2	Temperature controller module: Channel 2 auto-tuning command
Output	XGF-TC4UD_CH2_EXIN	BIT	Uxy.20.3	Temperature controller module: Channel 2 external input enable command
Output	XGF-TC4UD_CH3_RUN	BIT	Uxy.21.0	Temperature controller module: Channel 3 run command
Output	XGF-TC4UD_CH3_MAN	BIT	Uxy.21.1	Temperature controller module: Channel 3 manual mode command
Output	XGF-TC4UD_CH3_ATEN	BIT	Uxy.21.2	Temperature controller module: Channel 3 auto-tuning command
Output	XGF-TC4UD_CH3_EXIN	BIT	Uxy.21.3	Temperature controller module: Channel 3 external input enable command
Output	XGF-TC4UD_WRITE	BIT	Uxy.30.0	Temperature controller module: Parameter write command
Output	XGF-TC4UD_READ	BIT	Uxy.30.8	Temperature controller module: Parameter read command
Input	XGF-TC4UD_CH0_PV	Word	Uxy.06	Temperature controller module: Channel 0 Input value
Input	XGF-TC4UD_CH1_PV	Word	Uxy.07	Temperature controller module: Channel 1 Input value
Input	XGF-TC4UD_CH2_PV	Word	Uxy.08	Temperature controller module: Channel 2 Input value
Input	XGF-TC4UD_CH3_PV	Word	Uxy.09	Temperature controller module: Channel 3 Input value
Input	XGF-TC4UD_CH0_HOUT	Word	Uxy.10	Temperature controller module: Channel 0 heating output value
Input	XGF-TC4UD_CH1_HOUT	Word	Uxy.11	Temperature controller module: Channel 1 heating output value
Input	XGF-TC4UD_CH2_HOUT	Word	Uxy.12	Temperature controller module: Channel 2 heating output value

Input	XGF-TC4UD_CH3_HOUT	Word	Uxy.13	Temperature controller module: Channel 3 heating output value
Input	XGF-TC4UD_CH0_COUT	Word	Uxy.14	Temperature controller module: Channel 0 cooling output value
Input	XGF-TC4UD_CH1_COUT	Word	Uxy.15	Temperature controller module: Channel 1 cooling output value
Input	XGF-TC4UD_CH2_COUT	Word	Uxy.16	Temperature controller module: Channel 2 cooling output value
Input	XGF-TC4UD_CH3_COUT	Word	Uxy.17	Temperature controller module: Channel 3 cooling output value
Output	XGF-TC4UD_CH0_EXINV	Word	Uxy.22	Temperature controller module: Channel 0 external input data
Output	XGF-TC4UD_CH1_EXINV	Word	Uxy.23	Temperature controller module: Channel 1 external input data
Output	XGF-TC4UD_CH2_EXINV	Word	Uxy.24	Temperature controller module: Channel 2 external input data
Output	XGF-TC4UD_CH3_EXINV	Word	Uxy.25	Temperature controller module: Channel 3 external input data
Output	XGF-TC4UD_CH0_CSET	Word	Uxy.26	Temperature controller module: Channel 0 control set selection
Output	XGF-TC4UD_CH1_CSET	Word	Uxy.27	Temperature controller module: Channel 1 control set selection
Output	XGF-TC4UD_CH2_CSET	Word	Uxy.28	Temperature controller module: Channel 2 control set selection
Output	XGF-TC4UD_CH3_CSET	Word	Uxy.29	Temperature controller module: Channel 3 control set selection

2) Refresh data

<Input>

Input/Output	Variable	Type	Word(16BIT) Offset	Comment
Input	XGF-TC4UD_CH0_ACT	BIT	0.0	Temperature controller module: CH0 RUN
Input	XGF-TC4UD_CH1_ACT	BIT	0.1	Temperature controller module: CH1 RUN
Input	XGF-TC4UD_CH2_ACT	BIT	0.2	Temperature controller module: CH2 RUN
Input	XGF-TC4UD_CH3_ACT	BIT	0.3	Temperature controller module: CH3 RUN
Input	XGF-TC4UD_CH0_BOUT	BIT	0.4	Temperature controller module: Channel 0 disconnection flag
Input	XGF-TC4UD_CH1_BOUT	BIT	0.5	Temperature controller module: Channel 1 disconnection flag
Input	XGF-TC4UD_CH2_BOUT	BIT	0.6	Temperature controller module: Channel 2 disconnection flag
Input	XGF-TC4UD_CH3_BOUT	BIT	0.7	Temperature controller module: Channel 3 disconnection flag
Input	XGF-TC4UD_CH0_ADCERR	BIT	0.8	Temperature controller module: Channel 0 A/D conversion error
Input	XGF-TC4UD_CH1_ADCERR	BIT	0.9	Temperature controller module: Channel 1 A/D conversion error
Input	XGF-TC4UD_CH2_ADCERR	BIT	0.A	Temperature controller module: Channel 2 A/D conversion error
Input	XGF-	BIT	0.B	Temperature controller module: Channel 3 A/D conversion error

	TC4UD_CH3_ADCERR			
Input	XGF-TC4UD_CHECKSUMERR	BIT	0.D	Temperature controller module: Module backup memory error
Input	XGF-TC4UD_ERR	BIT	0.E	Temperature controller module: Module error
Input	XGF-TC4UD_RDY	BIT	0.F	Temperature controller module: Module ready
Input	XGF-TC4UD_WR_ING	BIT	1.0	Temperature controller module: Parameter writing
Input	XGF-TC4UD_RD_ING	BIT	1.8	Temperature controller module: Parameter reading
Input	XGF-TC4UD_CH0_ALINHH	BIT	2.0	Temperature controller module: Channel 0 input alarm HH limit
Input	XGF-TC4UD_CH0_ALINH	BIT	2.1	Temperature controller module: Channel 0 input alarm high limit
Input	XGF-TC4UD_CH0_ALINL	BIT	2.2	Temperature controller module: Channel 0 input alarm lower limit
Input	XGF-TC4UD_CH0_ALINLL	BIT	2.3	Temperature controller module: Channel 0 input alarm LL limit
Input	XGF-TC4UD_CH0_ALHOH	BIT	2.4	Temperature controller module: Channel 0 heat output alarm upper limit
Input	XGF-TC4UD_CH0_ALHOL	BIT	2.5	Temperature controller module: Channel 0 heat output alarm lower limit
Input	XGF-TC4UD_CH0_ALCOH	BIT	2.6	Temperature controller module: Channel 0 cooling output alarm upper limit
Input	XGF-TC4UD_CH0_ALCOL	BIT	2.7	Temperature controller module: Channel 0 cooling output alarm lower limit
Input	XGF-TC4UD_CH1_ALINHH	BIT	3.0	Temperature controller module: Channel 1 input alarm HH limit
Input	XGF-TC4UD_CH1_ALINH	BIT	3.1	Temperature controller module: Channel 1 input alarm high limit
Input	XGF-TC4UD_CH1_ALINL	BIT	3.2	Temperature controller module: Channel 1 input alarm lower limit
Input	XGF-TC4UD_CH1_ALINLL	BIT	3.3	Temperature controller module: Channel 1 input alarm LL limit
Input	XGF-TC4UD_CH1_ALHOH	BIT	3.4	Temperature controller module: Channel 1 heat output alarm upper limit
Input	XGF-TC4UD_CH1_ALHOL	BIT	3.5	Temperature controller module: Channel 1 heat output alarm lower limit
Input	XGF-TC4UD_CH1_ALCOH	BIT	3.6	Temperature controller module: Channel 1 cooling output alarm upper limit
Input	XGF-TC4UD_CH1_ALCOL	BIT	3.7	Temperature controller module: Channel 1 cooling output alarm lower limit
Input	XGF-TC4UD_CH2_ALINHH	BIT	4.0	Temperature controller module: Channel 2 input alarm HH limit
Input	XGF-TC4UD_CH2_ALINH	BIT	4.1	Temperature controller module: Channel 2 input alarm high limit
Input	XGF-TC4UD_CH2_ALINL	BIT	4.2	Temperature controller module: Channel 2 input alarm lower limit
Input	XGF-TC4UD_CH2_ALINLL	BIT	4.3	Temperature controller module: Channel 2 input alarm LL limit
Input	XGF-TC4UD_CH2_ALHOH	BIT	4.4	Temperature controller module: Channel 2 heat output alarm upper limit
Input	XGF-TC4UD_CH2_ALHOL	BIT	4.5	Temperature controller module: Channel 2 heat output alarm lower limit
Input	XGF-TC4UD_CH2_ALCOH	BIT	4.6	Temperature controller module: Channel 2 cooling output alarm upper limit

Appendix

Input	XGF-TC4UD_CH2_ALCOL	BIT	4.7	Temperature controller module: Channel 2 cooling output alarm lower limit
Input	XGF-TC4UD_CH3_ALINHH	BIT	5.0	Temperature controller module: Channel 3 input alarm HH limit
Input	XGF-TC4UD_CH3_ALINH	BIT	5.1	Temperature controller module: Channel 3 input alarm high limit
Input	XGF-TC4UD_CH3_ALINL	BIT	5.2	Temperature controller module: Channel 3 input alarm lower limit
Input	XGF-TC4UD_CH3_ALINLL	BIT	5.3	Temperature controller module: Channel 3 input alarm LL limit
Input	XGF-TC4UD_CH3_ALHOH	BIT	5.4	Temperature controller module: Channel 3 heat output alarm upper limit
Input	XGF-TC4UD_CH3_ALHOL	BIT	5.5	Temperature controller module: Channel 3 heat output alarm lower limit
Input	XGF-TC4UD_CH3_ALCOH	BIT	5.6	Temperature controller module: Channel 3 cooling output alarm upper limit
Input	XGF-TC4UD_CH3_ALCOL	BIT	5.7	Temperature controller module: Channel 3 cooling output alarm lower limit
Input	XGF-TC4UD_CH0_PV	Word	6	Temperature controller module: Channel 0 Input value
Input	XGF-TC4UD_CH1_PV	Word	7	Temperature controller module: Channel 1 Input value
Input	XGF-TC4UD_CH2_PV	Word	8	Temperature controller module: Channel 2 Input value
Input	XGF-TC4UD_CH3_PV	Word	9	Temperature controller module: Channel 3 Input value
Input	XGF-TC4UD_CH0_HOUT	Word	10	Temperature controller module: Channel 0 heating output value
Input	XGF-TC4UD_CH1_HOUT	Word	11	Temperature controller module: Channel 1 heating output value
Input	XGF-TC4UD_CH2_HOUT	Word	12	Temperature controller module: Channel 2 heating output value
Input	XGF-TC4UD_CH3_HOUT	Word	13	Temperature controller module: Channel 3 heating output value
Input	XGF-TC4UD_CH0_COUT	Word	14	Temperature controller module: Channel 0 cooling output value
Input	XGF-TC4UD_CH1_COUT	Word	15	Temperature controller module: Channel 1 cooling output value
Input	XGF-TC4UD_CH2_COUT	Word	16	Temperature controller module: Channel 2 cooling output value
Input	XGF-TC4UD_CH3_COUT	Word	17	Temperature controller module: Channel 3 cooling output value

<Output>

Input/Output	Variable	Type	Word(16BIT) Offset	Comment
Output	XGF-TC4UD_CH0_RUN	BIT	0.0	Temperature controller module: Channel 0 run command
Output	XGF-TC4UD_CH0_MAN	BIT	0.1	Temperature controller module: Channel 0 manual mode command
Output	XGF-TC4UD_CH0_ATEN	BIT	0.2	Temperature controller module: Channel 0 auto-tuning command
Output	XGF-TC4UD_CH0_EXIN	BIT	0.3	Temperature controller module: Channel 0 external input enable command
Output	XGF-TC4UD_CH1_RUN	BIT	1.0	Temperature controller module: Channel 1 run command
Output	XGF-TC4UD_CH1_MAN	BIT	1.1	Temperature controller module: Channel 1 manual mode command
Output	XGF-TC4UD_CH1_ATEN	BIT	1.2	Temperature controller module: Channel 1 auto-tuning command

Output	XGF-TC4UD_CH1_EXIN	BIT	1.3	Temperature controller module: Channel 1 external input enable command
Output	XGF-TC4UD_CH2_RUN	BIT	2.0	Temperature controller module: Channel 2 run command
Output	XGF-TC4UD_CH2_MAN	BIT	2.1	Temperature controller module: Channel 2 manual mode command
Output	XGF-TC4UD_CH2_ATEN	BIT	2.2	Temperature controller module: Channel 2 auto-tuning command
Output	XGF-TC4UD_CH2_EXIN	BIT	2.3	Temperature controller module: Channel 2 external input enable command
Output	XGF-TC4UD_CH3_RUN	BIT	3.0	Temperature controller module: Channel 3 run command
Output	XGF-TC4UD_CH3_MAN	BIT	3.1	Temperature controller module: Channel 3 manual mode command
Output	XGF-TC4UD_CH3_ATEN	BIT	3.2	Temperature controller module: Channel 3 auto-tuning command
Output	XGF-TC4UD_CH3_EXIN	BIT	3.3	Temperature controller module: Channel 3 external input enable command
Output	XGF-TC4UD_CH0_EXINV	Word	4	Temperature controller module: Channel 0 external input data
Output	XGF-TC4UD_CH1_EXINV	Word	5	Temperature controller module: Channel 1 external input data
Output	XGF-TC4UD_CH2_EXINV	Word	6	Temperature controller module: Channel 2 external input data
Output	XGF-TC4UD_CH3_EXINV	Word	7	Temperature controller module: Channel 3 external input data
Output	XGF-TC4UD_CH0_CSET	Word	8	Temperature controller module: Channel 0 control set selection
Output	XGF-TC4UD_CH1_CSET	Word	9	Temperature controller module: Channel 1 control set selection
Output	XGF-TC4UD_CH2_CSET	Word	10	Temperature controller module: Channel 2 control set selection
Output	XGF-TC4UD_CH3_CSET	Word	11	Temperature controller module: Channel 3 control set selection
Output	XGF-TC4UD_WRITE	BIT	12.0	Temperature controller module: Parameter write command
Output	XGF-TC4UD_READ	BIT	12.8	Temperature controller module: Parameter read command

(24) XGF-TC4RT

1) U Device

Input/Output	Variable	Type	Device	Comment
Input	XGF-TC4RT_CH0_ACT	BIT	Uxy.00.0	Temperature controller module: CH0 RUN
Input	XGF-TC4RT_CH1_ACT	BIT	Uxy.00.1	Temperature controller module: CH1 RUN
Input	XGF-TC4RT_CH2_ACT	BIT	Uxy.00.2	Temperature controller module: CH2 RUN
Input	XGF-TC4RT_CH3_ACT	BIT	Uxy.00.3	Temperature controller module: CH3 RUN
Input	XGF-TC4RT_CH0_BOUT	BIT	Uxy.00.4	Temperature controller module: Channel 0 disconnection flag
Input	XGF-TC4RT_CH1_BOUT	BIT	Uxy.00.5	Temperature controller module: Channel 1 disconnection flag

Appendix

Input	XGF-TC4RT_CH2_BOUT	BIT	Uxy.00.6	Temperature controller module: Channel 2 disconnection flag
Input	XGF-TC4RT_CH3_BOUT	BIT	Uxy.00.7	Temperature controller module: Channel 3 disconnection flag
Input	XGF-TC4RT_CH0_ADCERR	BIT	Uxy.00.8	Temperature controller module: Channel 0 A/D conversion error
Input	XGF-TC4RT_CH1_ADCERR	BIT	Uxy.00.9	Temperature controller module: Channel 1 A/D conversion error
Input	XGF-TC4RT_CH2_ADCERR	BIT	Uxy.00. A	Temperature controller module: Channel 2 A/D conversion error
Input	XGF-TC4RT_CH3_ADCERR	BIT	Uxy.00. B	Temperature controller module: Channel 3 A/D conversion error
Input	XGF-TC4RT_CHECKSUMERR	BIT	Uxy.00. D	Temperature controller module: Module backup memory error
Input	XGF-TC4RT_ERR	BIT	Uxy.00. E	Temperature controller module: Module error
Input	XGF-TC4RT_RDY	BIT	Uxy.00.F	Temperature controller module: Module ready
Input	XGF-TC4RT_WR_ING	BIT	Uxy.01.0	Temperature controller module: Parameter writing
Input	XGF-TC4RT_RD_ING	BIT	Uxy.01.8	Temperature controller module: Parameter reading
Input	XGF-TC4RT_CH0_ALINHH	BIT	Uxy.02.0	Temperature controller module: Channel 0 input alarm HH limit
Input	XGF-TC4RT_CH0_ALINH	BIT	Uxy.02.1	Temperature controller module: Channel 0 input alarm high limit
Input	XGF-TC4RT_CH0_ALINL	BIT	Uxy.02.2	Temperature controller module: Channel 0 input alarm lower limit
Input	XGF-TC4RT_CH0_ALINLL	BIT	Uxy.02.3	Temperature controller module: Channel 0 input alarm LL limit
Input	XGF-TC4RT_CH0_ALHOH	BIT	Uxy.02.4	Temperature controller module: Channel 0 heat output alarm upper limit
Input	XGF-TC4RT_CH0_ALHOL	BIT	Uxy.02.5	Temperature controller module: Channel 0 heat output alarm lower limit
Input	XGF-TC4RT_CH0_ALCOH	BIT	Uxy.02.6	Temperature controller module: Channel 0 cooling output alarm upper limit
Input	XGF-TC4RT_CH0_ALCOL	BIT	Uxy.02.7	Temperature controller module: Channel 0 cooling output alarm lower limit
Input	XGF-TC4RT_CH1_ALINHH	BIT	Uxy.03.0	Temperature controller module: Channel 1 input alarm HH limit
Input	XGF-TC4RT_CH1_ALINH	BIT	Uxy.03.1	Temperature controller module: Channel 1 input alarm high limit
Input	XGF-TC4RT_CH1_ALINL	BIT	Uxy.03.2	Temperature controller module: Channel 1 input alarm lower limit
Input	XGF-TC4RT_CH1_ALINLL	BIT	Uxy.03.3	Temperature controller module: Channel 1 input alarm LL limit
Input	XGF-TC4RT_CH1_ALHOH	BIT	Uxy.03.4	Temperature controller module: Channel 1 heat output alarm upper limit
Input	XGF-TC4RT_CH1_ALHOL	BIT	Uxy.03.5	Temperature controller module: Channel 1 heat output alarm lower limit
Input	XGF-TC4RT_CH1_ALCOH	BIT	Uxy.03.6	Temperature controller module: Channel 1 cooling output alarm upper limit
Input	XGF-TC4RT_CH1_ALCOL	BIT	Uxy.03.7	Temperature controller module: Channel 1 cooling output alarm lower limit
Input	XGF-TC4RT_CH2_ALINHH	BIT	Uxy.04.0	Temperature controller module: Channel 2 input alarm HH limit
Input	XGF-TC4RT_CH2_ALINH	BIT	Uxy.04.1	Temperature controller module: Channel 2 input alarm high limit
Input	XGF-TC4RT_CH2_ALINL	BIT	Uxy.04.2	Temperature controller module: Channel 2 input alarm lower limit
Input	XGF-TC4RT_CH2_ALINLL	BIT	Uxy.04.3	Temperature controller module: Channel 2 input alarm LL limit
Input	XGF-TC4RT_CH2_ALHOH	BIT	Uxy.04.4	Temperature controller module: Channel 2 heat output alarm upper limit
Input	XGF-TC4RT_CH2_ALHOL	BIT	Uxy.04.5	Temperature controller module: Channel 2 heat output alarm lower limit
Input	XGF-TC4RT_CH2_ALCOH	BIT	Uxy.04.6	Temperature controller module: Channel 2 cooling output alarm upper limit
Input	XGF-TC4RT_CH2_ALCOL	BIT	Uxy.04.7	Temperature controller module: Channel 2 cooling output alarm lower limit
Input	XGF-TC4RT_CH3_ALINHH	BIT	Uxy.05.0	Temperature controller module: Channel 3 input alarm HH limit
Input	XGF-TC4RT_CH3_ALINH	BIT	Uxy.05.1	Temperature controller module: Channel 3 input alarm high limit
Input	XGF-TC4RT_CH3_ALINL	BIT	Uxy.05.2	Temperature controller module: Channel 3 input alarm lower limit
Input	XGF-TC4RT_CH3_ALINLL	BIT	Uxy.05.3	Temperature controller module: Channel 3 input alarm LL limit

Input	XGF-TC4RT_CH3_ALHOH	BIT	Uxy.05.4	Temperature controller module: Channel 3 heat output alarm upper limit
Input	XGF-TC4RT_CH3_ALHOL	BIT	Uxy.05.5	Temperature controller module: Channel 3 heat output alarm lower limit
Input	XGF-TC4RT_CH3_ALCOH	BIT	Uxy.05.6	Temperature controller module: Channel 3 cooling output alarm upper limit
Input	XGF-TC4RT_CH3_ALCOL	BIT	Uxy.05.7	Temperature controller module: Channel 3 cooling output alarm lower limit
Output	XGF-TC4RT_CH0_RUN	BIT	Uxy.18.0	Temperature controller module: Channel 0 run command
Output	XGF-TC4RT_CH0_MAN	BIT	Uxy.18.1	Temperature controller module: Channel 0 manual mode command
Output	XGF-TC4RT_CH0_ATEN	BIT	Uxy.18.2	Temperature controller module: Channel 0 auto-tuning command
Output	XGF-TC4RT_CH0_EXIN	BIT	Uxy.18.3	Temperature controller module: Channel 0 external input enable command
Output	XGF-TC4RT_CH1_RUN	BIT	Uxy.19.0	Temperature controller module: Channel 1 run command
Output	XGF-TC4RT_CH1_MAN	BIT	Uxy.19.1	Temperature controller module: Channel 1 manual mode command
Output	XGF-TC4RT_CH1_ATEN	BIT	Uxy.19.2	Temperature controller module: Channel 1 auto-tuning command
Output	XGF-TC4RT_CH1_EXIN	BIT	Uxy.19.3	Temperature controller module: Channel 1 external input enable command
Output	XGF-TC4RT_CH2_RUN	BIT	Uxy.20.0	Temperature controller module: Channel 2 run command
Output	XGF-TC4RT_CH2_MAN	BIT	Uxy.20.1	Temperature controller module: Channel 2 manual mode command
Output	XGF-TC4RT_CH2_ATEN	BIT	Uxy.20.2	Temperature controller module: Channel 2 auto-tuning command
Output	XGF-TC4RT_CH2_EXIN	BIT	Uxy.20.3	Temperature controller module: Channel 2 external input enable command
Output	XGF-TC4RT_CH3_RUN	BIT	Uxy.21.0	Temperature controller module: Channel 3 run command
Output	XGF-TC4RT_CH3_MAN	BIT	Uxy.21.1	Temperature controller module: Channel 3 manual mode command
Output	XGF-TC4RT_CH3_ATEN	BIT	Uxy.21.2	Temperature controller module: Channel 3 auto-tuning command
Output	XGF-TC4RT_CH3_EXIN	BIT	Uxy.21.3	Temperature controller module: Channel 3 external input enable command
Output	XGF-TC4RT_WRITE	BIT	Uxy.30.0	Temperature controller module: Parameter write command
Output	XGF-TC4RT_READ	BIT	Uxy.30.8	Temperature controller module: Parameter read command
Input	XGF-TC4RT_CH0_PV	Word	Uxy.06	Temperature controller module: Channel 0 Input value
Input	XGF-TC4RT_CH1_PV	Word	Uxy.07	Temperature controller module: Channel 1 Input value
Input	XGF-TC4RT_CH2_PV	Word	Uxy.08	Temperature controller module: Channel 2 Input value
Input	XGF-TC4RT_CH3_PV	Word	Uxy.09	Temperature controller module: Channel 3 Input value
Input	XGF-TC4RT_CH0_HOUT	Word	Uxy.10	Temperature controller module: Channel 0 heating output value
Input	XGF-TC4RT_CH1_HOUT	Word	Uxy.11	Temperature controller module: Channel 1 heating output value
Input	XGF-TC4RT_CH2_HOUT	Word	Uxy.12	Temperature controller module: Channel 2 heating output value
Input	XGF-TC4RT_CH3_HOUT	Word	Uxy.13	Temperature controller module: Channel 3 heating output value
Input	XGF-TC4RT_CH0_COUT	Word	Uxy.14	Temperature controller module: Channel 0 cooling output value
Input	XGF-TC4RT_CH1_COUT	Word	Uxy.15	Temperature controller module: Channel 1 cooling output value
Input	XGF-TC4RT_CH2_COUT	Word	Uxy.16	Temperature controller module: Channel 2 cooling output value

		d		
Input	XGF-TC4RT_CH3_COUT	Word	Uxy.17	Temperature controller module: Channel 3 cooling output value
Output	XGF-TC4RT_CH0_EXINV	Word	Uxy.22	Temperature controller module: Channel 0 external input data
Output	XGF-TC4RT_CH1_EXINV	Word	Uxy.23	Temperature controller module: Channel 1 external input data
Output	XGF-TC4RT_CH2_EXINV	Word	Uxy.24	Temperature controller module: Channel 2 external input data
Output	XGF-TC4RT_CH3_EXINV	Word	Uxy.25	Temperature controller module: Channel 3 external input data
Output	XGF-TC4RT_CH0_CSET	Word	Uxy.26	Temperature controller module: Channel 0 control set selection
Output	XGF-TC4RT_CH1_CSET	Word	Uxy.27	Temperature controller module: Channel 1 control set selection
Output	XGF-TC4RT_CH2_CSET	Word	Uxy.28	Temperature controller module: Channel 2 control set selection
Output	XGF-TC4RT_CH3_CSET	Word	Uxy.29	Temperature controller module: Channel 3 control set selection

2) Refresh data

<Input>

Input/Output	Variable	Type	Word(16BIT) Offset	Comment
Input	XGF-TC4RT_CH0_ACT	BIT	0.0	Temperature controller module: CH0 RUN
Input	XGF-TC4RT_CH1_ACT	BIT	0.1	Temperature controller module: CH1 RUN
Input	XGF-TC4RT_CH2_ACT	BIT	0.2	Temperature controller module: CH2 RUN
Input	XGF-TC4RT_CH3_ACT	BIT	0.3	Temperature controller module: CH3 RUN
Input	XGF-TC4RT_CH0_BOUT	BIT	0.4	Temperature controller module: Channel 0 disconnection flag
Input	XGF-TC4RT_CH1_BOUT	BIT	0.5	Temperature controller module: Channel 1 disconnection flag
Input	XGF-TC4RT_CH2_BOUT	BIT	0.6	Temperature controller module: Channel 2 disconnection flag
Input	XGF-TC4RT_CH3_BOUT	BIT	0.7	Temperature controller module: Channel 3 disconnection flag
Input	XGF-TC4RT_CH0_ADCERR	BIT	0.8	Temperature controller module: Channel 0 A/D conversion error
Input	XGF-TC4RT_CH1_ADCERR	BIT	0.9	Temperature controller module: Channel 1 A/D conversion error
Input	XGF-TC4RT_CH2_ADCERR	BIT	0.A	Temperature controller module: Channel 2 A/D conversion error
Input	XGF-TC4RT_CH3_ADCERR	BIT	0.B	Temperature controller module: Channel 3 A/D conversion error
Input	XGF-TC4RT_CHECKSUMERR	BIT	0.D	Temperature controller module: Module backup memory error
Input	XGF-TC4RT_ERR	BIT	0.E	Temperature controller module: Module error
Input	XGF-TC4RT_RDY	BIT	0.F	Temperature controller module: Module ready
Input	XGF-TC4RT_WR_ING	BIT	1.0	Temperature controller module: Parameter writing

Input	XGF-TC4RT_RD_ING	BIT	1.8	Temperature controller module: Parameter reading
Input	XGF-TC4RT_CH0_ALINHH	BIT	2.0	Temperature controller module: Channel 0 input alarm HH limit
Input	XGF-TC4RT_CH0_ALINH	BIT	2.1	Temperature controller module: Channel 0 input alarm high limit
Input	XGF-TC4RT_CH0_ALINL	BIT	2.2	Temperature controller module: Channel 0 input alarm lower limit
Input	XGF-TC4RT_CH0_ALINLL	BIT	2.3	Temperature controller module: Channel 0 input alarm LL limit
Input	XGF-TC4RT_CH0_ALHOH	BIT	2.4	Temperature controller module: Channel 0 heat output alarm upper limit
Input	XGF-TC4RT_CH0_ALHOL	BIT	2.5	Temperature controller module: Channel 0 heat output alarm lower limit
Input	XGF-TC4RT_CH0_ALCOH	BIT	2.6	Temperature controller module: Channel 0 cooling output alarm upper limit
Input	XGF-TC4RT_CH0_ALCOL	BIT	2.7	Temperature controller module: Channel 0 cooling output alarm lower limit
Input	XGF-TC4RT_CH1_ALINHH	BIT	3.0	Temperature controller module: Channel 1 input alarm HH limit
Input	XGF-TC4RT_CH1_ALINH	BIT	3.1	Temperature controller module: Channel 1 input alarm high limit
Input	XGF-TC4RT_CH1_ALINL	BIT	3.2	Temperature controller module: Channel 1 input alarm lower limit
Input	XGF-TC4RT_CH1_ALINLL	BIT	3.3	Temperature controller module: Channel 1 input alarm LL limit
Input	XGF-TC4RT_CH1_ALHOH	BIT	3.4	Temperature controller module: Channel 1 heat output alarm upper limit
Input	XGF-TC4RT_CH1_ALHOL	BIT	3.5	Temperature controller module: Channel 1 heat output alarm lower limit
Input	XGF-TC4RT_CH1_ALCOH	BIT	3.6	Temperature controller module: Channel 1 cooling output alarm upper limit
Input	XGF-TC4RT_CH1_ALCOL	BIT	3.7	Temperature controller module: Channel 1 cooling output alarm lower limit
Input	XGF-TC4RT_CH2_ALINHH	BIT	4.0	Temperature controller module: Channel 2 input alarm HH limit
Input	XGF-TC4RT_CH2_ALINH	BIT	4.1	Temperature controller module: Channel 2 input alarm high limit
Input	XGF-TC4RT_CH2_ALINL	BIT	4.2	Temperature controller module: Channel 2 input alarm lower limit
Input	XGF-TC4RT_CH2_ALINLL	BIT	4.3	Temperature controller module: Channel 2 input alarm LL limit
Input	XGF-TC4RT_CH2_ALHOH	BIT	4.4	Temperature controller module: Channel 2 heat output alarm upper limit
Input	XGF-TC4RT_CH2_ALHOL	BIT	4.5	Temperature controller module: Channel 2 heat output alarm lower limit
Input	XGF-TC4RT_CH2_ALCOH	BIT	4.6	Temperature controller module: Channel 2 cooling output alarm upper limit
Input	XGF-TC4RT_CH2_ALCOL	BIT	4.7	Temperature controller module: Channel 2 cooling output alarm lower limit
Input	XGF-TC4RT_CH3_ALINHH	BIT	5.0	Temperature controller module: Channel 3 input alarm HH limit
Input	XGF-TC4RT_CH3_ALINH	BIT	5.1	Temperature controller module: Channel 3 input alarm high limit
Input	XGF-TC4RT_CH3_ALINL	BIT	5.2	Temperature controller module: Channel 3 input alarm lower limit
Input	XGF-TC4RT_CH3_ALINLL	BIT	5.3	Temperature controller module: Channel 3 input alarm LL limit
Input	XGF-TC4RT_CH3_ALHOH	BIT	5.4	Temperature controller module: Channel 3 heat output alarm upper limit

Appendix

Input	XGF-TC4RT_CH3_ALHOL	BIT	5.5	Temperature controller module: Channel 3 heat output alarm lower limit
Input	XGF-TC4RT_CH3_ALCOH	BIT	5.6	Temperature controller module: Channel 3 cooling output alarm upper limit
Input	XGF-TC4RT_CH3_ALCOL	BIT	5.7	Temperature controller module: Channel 3 cooling output alarm lower limit
Input	XGF-TC4RT_CH0_PV	Word	6	Temperature controller module: Channel 0 Input value
Input	XGF-TC4RT_CH1_PV	Word	7	Temperature controller module: Channel 1 Input value
Input	XGF-TC4RT_CH2_PV	Word	8	Temperature controller module: Channel 2 Input value
Input	XGF-TC4RT_CH3_PV	Word	9	Temperature controller module: Channel 3 Input value
Input	XGF-TC4RT_CH0_HOUT	Word	10	Temperature controller module: Channel 0 heating output value
Input	XGF-TC4RT_CH1_HOUT	Word	11	Temperature controller module: Channel 1 heating output value
Input	XGF-TC4RT_CH2_HOUT	Word	12	Temperature controller module: Channel 2 heating output value
Input	XGF-TC4RT_CH3_HOUT	Word	13	Temperature controller module: Channel 3 heating output value
Input	XGF-TC4RT_CH0_COUT	Word	14	Temperature controller module: Channel 0 cooling output value
Input	XGF-TC4RT_CH1_COUT	Word	15	Temperature controller module: Channel 1 cooling output value
Input	XGF-TC4RT_CH2_COUT	Word	16	Temperature controller module: Channel 2 cooling output value
Input	XGF-TC4RT_CH3_COUT	Word	17	Temperature controller module: Channel 3 cooling output value

<Output>

Input/Output	Variable	Type	Word(16BIT) Offset	Comment
Output	XGF-TC4RT_CH0_RUN	BIT	0.0	Temperature controller module: Channel 0 run command
Output	XGF-TC4RT_CH0_MAN	BIT	0.1	Temperature controller module: Channel 0 manual mode command
Output	XGF-TC4RT_CH0_ATEN	BIT	0.2	Temperature controller module: Channel 0 auto-tuning command
Output	XGF-TC4RT_CH0_EXIN	BIT	0.3	Temperature controller module: Channel 0 external input enable command
Output	XGF-TC4RT_CH1_RUN	BIT	1.0	Temperature controller module: Channel 1 run command
Output	XGF-TC4RT_CH1_MAN	BIT	1.1	Temperature controller module: Channel 1 manual mode command
Output	XGF-TC4RT_CH1_ATEN	BIT	1.2	Temperature controller module: Channel 1 auto-tuning command
Output	XGF-TC4RT_CH1_EXIN	BIT	1.3	Temperature controller module: Channel 1 external input enable command
Output	XGF-TC4RT_CH2_RUN	BIT	2.0	Temperature controller module: Channel 2 run command
Output	XGF-TC4RT_CH2_MAN	BIT	2.1	Temperature controller module: Channel 2 manual mode command
Output	XGF-TC4RT_CH2_ATEN	BIT	2.2	Temperature controller module: Channel 2 auto-tuning command
Output	XGF-TC4RT_CH2_EXIN	BIT	2.3	Temperature controller module: Channel 2 external input enable command
Output	XGF-TC4RT_CH3_RUN	BIT	3.0	Temperature controller module: Channel 3 run command
Output	XGF-TC4RT_CH3_MAN	BIT	3.1	Temperature controller module: Channel 3 manual mode command
Output	XGF-TC4RT_CH3_ATEN	BIT	3.2	Temperature controller module: Channel 3 auto-tuning command
Output	XGF-TC4RT_CH3_EXIN	BIT	3.3	Temperature controller module: Channel 3 external input enable command
Output	XGF-	Word	4	Temperature controller module: Channel 0 external input data

	TC4RT_CH0_EXINV			
Output	XGF-TC4RT_CH1_EXINV	Word	5	Temperature controller module: Channel 1 external input data
Output	XGF-TC4RT_CH2_EXINV	Word	6	Temperature controller module: Channel 2 external input data
Output	XGF-TC4RT_CH3_EXINV	Word	7	Temperature controller module: Channel 3 external input data
Output	XGF-TC4RT_CH0_CSET	Word	8	Temperature controller module: Channel 0 control set selection
Output	XGF-TC4RT_CH1_CSET	Word	9	Temperature controller module: Channel 1 control set selection
Output	XGF-TC4RT_CH2_CSET	Word	10	Temperature controller module: Channel 2 control set selection
Output	XGF-TC4RT_CH3_CSET	Word	11	Temperature controller module: Channel 3 control set selection
Output	XGF-TC4RT_WRITE	BIT	12.0	Temperature controller module: Parameter write command
Output	XGF-TC4RT_READ	BIT	12.8	Temperature controller module: Parameter read command

A.3.2 Smart I/O expansion Mounting Module

(1) XBF-AD04A

1) U Device

Input/Output	Variable	Type	Device	Comment
Input	XBF-AD04A_ERR	BIT	Uxy.00.0	Analog input module: Module error
Input	XBF-AD04A_RDY	BIT	Uxy.00.F	Analog input module: Module ready
Input	XBF-AD04A_CH0_ACT	BIT	Uxy.01.0	Analog input module: CH0 RUN
Input	XBF-AD04A_CH1_ACT	BIT	Uxy.01.1	Analog input module: CH1 RUN
Input	XBF-AD04A_CH2_ACT	BIT	Uxy.01.2	Analog input module: CH2 RUN
Input	XBF-AD04A_CH3_ACT	BIT	Uxy.01.3	Analog input module: CH3 RUN
Output	XBF-AD04A_ERR_CLR	BIT	Uxy.11.0	Analog input module: Error clear request
Input	XBF-AD04A_CH0_DATA	Word	Uxy.02	Analog input module: CH0 conversion value
Input	XBF-AD04A_CH1_DATA	Word	Uxy.03	Analog input module: CH1 conversion value
Input	XBF-AD04A_CH2_DATA	Word	Uxy.04	Analog input module: CH2 conversion value
Input	XBF-AD04A_CH3_DATA	Word	Uxy.05	Analog input module: CH3 conversion value

2) Refresh data

<Input>

Input/Output	Variable	Type	Word(16BIT) Offset	Comment
Input	XBF-AD04A_ERR	BIT	0.0	Analog input module: Module error
Input	XBF-AD04A_RDY	BIT	0.F	Analog input module: Module ready
Input	XBF-AD04A_CH0_ACT	BIT	1.0	Analog input module: CH0 RUN
Input	XBF-AD04A_CH1_ACT	BIT	1.1	Analog input module: CH1 RUN
Input	XBF-AD04A_CH2_ACT	BIT	1.2	Analog input module: CH2 RUN
Input	XBF-AD04A_CH3_ACT	BIT	1.3	Analog input module: CH3 RUN
Input	XBF-AD04A_CH0_DATA	Word	2	Analog input module: CH0 conversion value
Input	XBF-AD04A_CH1_DATA	Word	3	Analog input module: CH1 conversion value

Appendix

Input	XBF-AD04A_CH2_DATA	Word	4	Analog input module: CH2 conversion value
Input	XBF-AD04A_CH3_DATA	Word	5	Analog input module: CH3 conversion value

<Output>

Input/Output	Variable	Type	Word(16BIT) Offset	Comment
Output	XBF-AD04A_ERR_CLR	BIT	0.0	Analog input module: Error clear request

(2) XBF-AD04C

1) U Device

Input/Output	Variable	Type	Device	Comment
Input	XBF-AD04C_ERR	BIT	Uxy.00.0	Analog input module: Module error
Input	XBF-AD04C_RDY	BIT	Uxy.00.F	Analog input module: Module ready
Input	XBF-AD04C_CH0_ACT	BIT	Uxy.01.0	Analog input module: CH0 RUN
Input	XBF-AD04C_CH1_ACT	BIT	Uxy.01.1	Analog input module: CH1 RUN
Input	XBF-AD04C_CH2_ACT	BIT	Uxy.01.2	Analog input module: CH2 RUN
Input	XBF-AD04C_CH3_ACT	BIT	Uxy.01.3	Analog input module: CH3 RUN
Input	XBF-AD04C_CH0_ERR	BIT	Uxy.01.8	Analog input module: Channel 0 error
Input	XBF-AD04C_CH1_ERR	BIT	Uxy.01.9	Analog input module: Channel 1 error
Input	XBF-AD04C_CH2_ERR	BIT	Uxy.01.A	Analog input module: Channel 2 error
Input	XBF-AD04C_CH3_ERR	BIT	Uxy.01.B	Analog input module: Channel 3 error
Input	XBF-AD04C_CH0_IDD	BIT	Uxy.10.0	Analog input module: CH0 input disconnection detection
Input	XBF-AD04C_CH1_IDD	BIT	Uxy.10.1	Analog input module: CH1 input disconnection detection
Input	XBF-AD04C_CH2_IDD	BIT	Uxy.10.2	Analog input module: CH2 input disconnection detection
Input	XBF-AD04C_CH3_IDD	BIT	Uxy.10.3	Analog input module: CH3 input disconnection detection
Input	XBF-AD04C_CH0_HOOR	BIT	Uxy.11.0	Analog input module: Channel 0 alarm upper limit
Input	XBF-AD04C_CH1_HOOR	BIT	Uxy.11.1	Analog input module: Channel 1 alarm upper limit
Input	XBF-AD04C_CH2_HOOR	BIT	Uxy.11.2	Analog input module: Channel 2 alarm upper limit
Input	XBF-AD04C_CH3_HOOR	BIT	Uxy.11.3	Analog input module: Channel 3 alarm upper limit
Input	XBF-AD04C_CH0_LOOR	BIT	Uxy.12.0	Analog input module: Channel 0 alarm lower limit
Input	XBF-AD04C_CH1_LOOR	BIT	Uxy.12.1	Analog input module: Channel 1 alarm lower limit
Input	XBF-AD04C_CH2_LOOR	BIT	Uxy.12.2	Analog input module: Channel 2 alarm lower limit
Input	XBF-AD04C_CH3_LOOR	BIT	Uxy.12.3	Analog input module: Channel 3 alarm lower limit
Output	XBF-AD04C_ERR_CLR	BIT	Uxy.13.0	Analog input module: Error clear request
Input	XBF-AD04C_CH0_DATA	Word	Uxy.02	Analog input module: CH0 conversion value
Input	XBF-AD04C_CH1_DATA	Word	Uxy.03	Analog input module: CH1 conversion value
Input	XBF-AD04C_CH2_DATA	Word	Uxy.04	Analog input module: CH2 conversion value
Input	XBF-AD04C_CH3_DATA	Word	Uxy.05	Analog input module: CH3 conversion value

2) Refresh data

<Input>

Input/Output	Variable	Type	Word(16BIT) Offset	Comment
Input	XBF-AD04C_ERR	BIT	0.0	Analog input module: Module error
Input	XBF-AD04C_RDY	BIT	0.F	Analog input module: Module ready
Input	XBF-AD04C_CH0_ACT	BIT	1.0	Analog input module: CH0 RUN
Input	XBF-AD04C_CH1_ACT	BIT	1.1	Analog input module: CH1 RUN
Input	XBF-AD04C_CH2_ACT	BIT	1.2	Analog input module: CH2 RUN

Input	XBF-AD04C_CH3_ACT	BIT	1.3	Analog input module: CH3 RUN
Input	XBF-AD04C_CH0_ERR	BIT	1.8	Analog input module: Channel 0 error
Input	XBF-AD04C_CH1_ERR	BIT	1.9	Analog input module: Channel 1 error
Input	XBF-AD04C_CH2_ERR	BIT	1.A	Analog input module: Channel 2 error
Input	XBF-AD04C_CH3_ERR	BIT	1.B	Analog input module: Channel 3 error
Input	XBF-AD04C_CH0_DATA	Word	2	Analog input module: CH0 conversion value
Input	XBF-AD04C_CH1_DATA	Word	3	Analog input module: CH1 conversion value
Input	XBF-AD04C_CH2_DATA	Word	4	Analog input module: CH2 conversion value
Input	XBF-AD04C_CH3_DATA	Word	5	Analog input module: CH3 conversion value
Input		WORD	6	Reserved
Input		WORD	7	Reserved
Input		WORD	8	Reserved
Input		WORD	9	Reserved
Input	XBF-AD04C_CH0_IDD	BIT	10.0	Analog input module: CH0 input disconnection detection
Input	XBF-AD04C_CH1_IDD	BIT	10.1	Analog input module: CH1 input disconnection detection
Input	XBF-AD04C_CH2_IDD	BIT	10.2	Analog input module: CH2 input disconnection detection
Input	XBF-AD04C_CH3_IDD	BIT	10.3	Analog input module: CH3 input disconnection detection
Input	XBF-AD04C_CH0_HOOR	BIT	11.0	Analog input module: Channel 0 alarm upper limit
Input	XBF-AD04C_CH1_HOOR	BIT	11.1	Analog input module: Channel 1 alarm upper limit
Input	XBF-AD04C_CH2_HOOR	BIT	11.2	Analog input module: Channel 2 alarm upper limit
Input	XBF-AD04C_CH3_HOOR	BIT	11.3	Analog input module: Channel 3 alarm upper limit
Input	XBF-AD04C_CH0_LOOR	BIT	12.0	Analog input module: Channel 0 alarm lower limit
Input	XBF-AD04C_CH1_LOOR	BIT	12.1	Analog input module: Channel 1 alarm lower limit
Input	XBF-AD04C_CH2_LOOR	BIT	12.2	Analog input module: Channel 2 alarm lower limit
Input	XBF-AD04C_CH3_LOOR	BIT	12.3	Analog input module: Channel 3 alarm lower limit

<Output>

Input/Output	Variable	Type	Word(16BIT) Offset	Comment
Output	XBF-AD04C_ERR_CLR	BIT	0.0	Analog input module: Error clear request

(3) XBF-AD08A

1) U Device

Input/Output	Variable	Type	Device	Comment
Input	XBF-AD08A_ERR	BIT	Uxy.00.0	Analog input module: Module error
Input	XBF-AD08A_RDY	BIT	Uxy.00.F	Analog input module: Module ready
Input	XBF-AD08A_CH0_ACT	BIT	Uxy.01.0	Analog input module: CH0 RUN
Input	XBF-AD08A_CH1_ACT	BIT	Uxy.01.1	Analog input module: CH1 RUN
Input	XBF-AD08A_CH2_ACT	BIT	Uxy.01.2	Analog input module: CH2 RUN
Input	XBF-AD08A_CH3_ACT	BIT	Uxy.01.3	Analog input module: CH3 RUN
Input	XBF-AD08A_CH4_ACT	BIT	Uxy.01.4	Analog input module: CH4 RUN
Input	XBF-AD08A_CH5_ACT	BIT	Uxy.01.5	Analog input module: CH5 RUN
Input	XBF-AD08A_CH6_ACT	BIT	Uxy.01.6	Analog input module: CH6 RUN
Input	XBF-AD08A_CH7_ACT	BIT	Uxy.01.7	Analog input module: CH7 RUN
Input	XBF-AD08A_CH0_ERR	BIT	Uxy.01.8	Analog input module: Channel 0 error
Input	XBF-AD08A_CH1_ERR	BIT	Uxy.01.9	Analog input module: Channel 1 error
Input	XBF-AD08A_CH2_ERR	BIT	Uxy.01.A	Analog input module: Channel 2 error
Input	XBF-AD08A_CH3_ERR	BIT	Uxy.01.B	Analog input module: Channel 3 error

Input	XBF-AD08A_CH4_ERR	BIT	Uxy.01.C	Analog input module: Channel 4 error
Input	XBF-AD08A_CH5_ERR	BIT	Uxy.01.D	Analog input module: Channel 5 error
Input	XBF-AD08A_CH6_ERR	BIT	Uxy.01.E	Analog input module: Channel 6 error
Input	XBF-AD08A_CH7_ERR	BIT	Uxy.01.F	Analog input module: Channel 7 error
Input	XBF-AD08A_CH0_IDD	BIT	Uxy.10.0	Analog input module: Channel 0 disconnection flag
Input	XBF-AD08A_CH1_IDD	BIT	Uxy.10.1	Analog input module: Channel 1 disconnection flag
Input	XBF-AD08A_CH2_IDD	BIT	Uxy.10.2	Analog input module: Channel 2 disconnection flag
Input	XBF-AD08A_CH3_IDD	BIT	Uxy.10.3	Analog input module: Channel 3 disconnection flag
Input	XBF-AD08A_CH4_IDD	BIT	Uxy.10.4	Analog input module: Channel 4 disconnection flag
Input	XBF-AD08A_CH5_IDD	BIT	Uxy.10.5	Analog input module: Channel 5 disconnection flag
Input	XBF-AD08A_CH6_IDD	BIT	Uxy.10.6	Analog input module: Channel 6 disconnection flag
Input	XBF-AD08A_CH7_IDD	BIT	Uxy.10.7	Analog input module: Channel 7 disconnection flag
Output	XBF-AD08A_ERR_CLR	BIT	Uxy.11.0	Analog input module: Error clear request
Input	XBF-AD08A_CH0_DATA	Word	Uxy.02	Analog input module: Channel 0 output value
Input	XBF-AD08A_CH1_DATA	Word	Uxy.03	Analog input module: Channel 1 output value
Input	XBF-AD08A_CH2_DATA	Word	Uxy.04	Analog input module: Channel 2 output value
Input	XBF-AD08A_CH3_DATA	Word	Uxy.05	Analog input module: Channel 3 output value
Input	XBF-AD08A_CH4_DATA	Word	Uxy.06	Analog input module: Channel 4 output value
Input	XBF-AD08A_CH5_DATA	Word	Uxy.07	Analog input module: Channel 5 output value
Input	XBF-AD08A_CH6_DATA	Word	Uxy.08	Analog input module: Channel 6 output value
Input	XBF-AD08A_CH7_DATA	Word	Uxy.09	Analog input module: Channel 7 output value

2) Refresh data

<Input>

Input/Output	Variable	Type	Word(16BIT) Offset	Comment
Input	XBF-AD08A_ERR	BIT	0.0	Analog input module: Module error
Input	XBF-AD08A_RDY	BIT	0.F	Analog input module: Module ready
Input	XBF-AD08A_CH0_ACT	BIT	1.0	Analog input module: CH0 RUN
Input	XBF-AD08A_CH1_ACT	BIT	1.1	Analog input module: CH1 RUN
Input	XBF-AD08A_CH2_ACT	BIT	1.2	Analog input module: CH2 RUN
Input	XBF-AD08A_CH3_ACT	BIT	1.3	Analog input module: CH3 RUN
Input	XBF-AD08A_CH4_ACT	BIT	1.4	Analog input module: CH4 RUN
Input	XBF-AD08A_CH5_ACT	BIT	1.5	Analog input module: CH5 RUN
Input	XBF-AD08A_CH6_ACT	BIT	1.6	Analog input module: CH6 RUN
Input	XBF-AD08A_CH7_ACT	BIT	1.7	Analog input module: CH7 RUN
Input	XBF-AD08A_CH0_ERR	BIT	1.8	Analog input module: Channel 0 error
Input	XBF-AD08A_CH1_ERR	BIT	1.9	Analog input module: Channel 1 error
Input	XBF-AD08A_CH2_ERR	BIT	01.A	Analog input module: Channel 2 error
Input	XBF-AD08A_CH3_ERR	BIT	01.B	Analog input module: Channel 3 error
Input	XBF-AD08A_CH4_ERR	BIT	01.C	Analog input module: Channel 4 error
Input	XBF-AD08A_CH5_ERR	BIT	01.D	Analog input module: Channel 5 error
Input	XBF-AD08A_CH6_ERR	BIT	01.E	Analog input module: Channel 6 error
Input	XBF-AD08A_CH7_ERR	BIT	01.F	Analog input module: Channel 7 error
Input	XBF-AD08A_CH0_DATA	Word	2	Analog input module: Channel 0 output value
Input	XBF-AD08A_CH1_DATA	Word	3	Analog input module: Channel 1 output value
Input	XBF-AD08A_CH2_DATA	Word	4	Analog input module: Channel 2 output value
Input	XBF-AD08A_CH3_DATA	Word	5	Analog input module: Channel 3 output value

Input	XBF-AD08A_CH4_DATA	Word	6	Analog input module: Channel 4 output value
Input	XBF-AD08A_CH5_DATA	Word	7	Analog input module: Channel 5 output value
Input	XBF-AD08A_CH6_DATA	Word	8	Analog input module: Channel 6 output value
Input	XBF-AD08A_CH7_DATA	Word	9	Analog input module: Channel 7 output value
Input	XBF-AD08A_CH0_IDD	BIT	10.0	Analog input module: Channel 0 disconnection flag
Input	XBF-AD08A_CH1_IDD	BIT	10.1	Analog input module: Channel 1 disconnection flag
Input	XBF-AD08A_CH2_IDD	BIT	10.2	Analog input module: Channel 2 disconnection flag
Input	XBF-AD08A_CH3_IDD	BIT	10.3	Analog input module: Channel 3 disconnection flag
Input	XBF-AD08A_CH4_IDD	BIT	10.4	Analog input module: Channel 4 disconnection flag
Input	XBF-AD08A_CH5_IDD	BIT	10.5	Analog input module: Channel 5 disconnection flag
Input	XBF-AD08A_CH6_IDD	BIT	10.6	Analog input module: Channel 6 disconnection flag
Input	XBF-AD08A_CH7_IDD	BIT	10.7	Analog input module: Channel 7 disconnection flag

<Output>

Input/Output	Variable	Type	Word(16BIT) Offset	Comment
Output	XBF-AD08A_ERR_CLR	BIT	0.0	Analog input module: Error clear request

(4) XBF-AH04A

1) U Device

Input/Output	Variable	Type	Device	Comment
Input	XBF-AH04A_ERR	BIT	Uxy.00.0	Analog IO Module: Module error
Input	XBF-AH04A_RDY	BIT	Uxy.00.F	Analog IO Module: Module ready
Input	XBF-AH04A_AD0_ACT	BIT	Uxy.01.0	Analog IO Module: Input Channel 0 Running
Input	XBF-AH04A_AD1_ACT	BIT	Uxy.01.1	Analog IO Module: Input Channel 1 Running
Input	XBF-AH04A_DA0_ACT	BIT	Uxy.01.2	Analog IO Module: Output Channel 0 Running
Input	XBF-AH04A_DA1_ACT	BIT	Uxy.01.3	Analog IO Module: Output Channel 1 Running
Input	XBF-AH04A_AD0_IDD	BIT	Uxy.01.4	Analog IO Module: Input Channel 0 Disconnection Flag
Input	XBF-AH04A_AD1_IDD	BIT	Uxy.01.5	Analog IO Module: Input Channel 1 Disconnection Flag
Input	XBF-AH04A_AD0_ERR	BIT	Uxy.01.8	Analog IO Module: Input Channel 0 error
Input	XBF-AH04A_AD1_ERR	BIT	Uxy.01.9	Analog IO Module: Input Channel 1 error
Input	XBF-AH04A_DA0_ERR	BIT	Uxy.01.A	Analog IO Module: Output Channel 0 error
Input	XBF-AH04A_DA1_ERR	BIT	Uxy.01.B	Analog IO Module: Output Channel 1 error
Output	XBF-AH04A_DA0_OUTEN	BIT	Uxy.06.0	Analog IO Module: Output channel 0 output enable
Output	XBF-AH04A_DA1_OUTEN	BIT	Uxy.06.1	Analog IO Module: Output channel 1 output enable
Input	XBF-AH04A_AD0_DATA	Word	Uxy.04	Analog IO Module: Input Channel 0 Digital Output Data
Input	XBF-AH04A_AD1_DATA	Word	Uxy.05	Analog IO Module: Input Channel 1 Digital Output Data
Output	XBF-AH04A_DA0_DATA	Word	Uxy.07	Analog IO Module: Output Channel 0 Digital Input Data
Output	XBF-AH04A_DA1_DATA	Word	Uxy.08	Analog IO Module: Output Channel 1 Digital Input Data

2) Refresh data

<Input>

Input/Output	Variable	Type	Word(16BIT) Offset	Comment
Input	XBF-AH04A_ERR	BIT	0.0	Analog IO Module: Module error
Input	XBF-AH04A_RDY	BIT	0.F	Analog IO Module: Module ready
Input	XBF-AH04A_AD0_ACT	BIT	1.0	Analog IO Module: Input Channel 0 Running
Input	XBF-AH04A_AD1_ACT	BIT	1.1	Analog IO Module: Input Channel 1 Running

Appendix

Input	XBF-AH04A_DA0_ACT	BIT	1.2	Analog IO Module: Output Channel 0 Running
Input	XBF-AH04A_DA1_ACT	BIT	1.3	Analog IO Module: Output Channel 1 Running
Input	XBF-AH04A_AD0_IDD	BIT	1.4	Analog IO Module: Input Channel 0 Disconnection Flag
Input	XBF-AH04A_AD1_IDD	BIT	1.5	Analog IO Module: Input Channel 1 Disconnection Flag
Input	XBF-AH04A_AD0_ERR	BIT	1.8	Analog IO Module: Input Channel 0 error
Input	XBF-AH04A_AD1_ERR	BIT	1.9	Analog IO Module: Input Channel 1 error
Input	XBF-AH04A_DA0_ERR	BIT	1.A	Analog IO Module: Output Channel 0 error
Input	XBF-AH04A_DA1_ERR	BIT	1.B	Analog IO Module: Output Channel 1 error
Input		WORD	2	Reserved
Input		WORD	3	Reserved
Input	XBF-AH04A_AD0_DATA	Word	4	Analog IO Module: Input Channel 0 Digital Output Data
Input	XBF-AH04A_AD1_DATA	Word	5	Analog IO Module: Input Channel 1 Digital Output Data

<Output>

Input/Output	Variable	Type	Word(16BIT) Offset	Comment
Output	XBF-AH04A_DA0_OUTEN	BIT	0.0	Analog IO Module: Output channel 0 output enable
Output	XBF-AH04A_DA1_OUTEN	BIT	0.1	Analog IO Module: Output channel 1 output enable
Output	XBF-AH04A_DA0_DATA	Word	1	Analog IO Module: Output Channel 0 Digital Input Data
Output	XBF-AH04A_DA1_DATA	Word	2	Analog IO Module: Output Channel 1 Digital Input Data

(5) XBF-DC04A

1) U Device

Input/Output	Variable	Type	Device	Comment
Input	XBF-DC04A_CH0_ERR	BIT	Uxy.00.0	Analog Output module: Channel 0 error
Input	XBF-DC04A_CH1_ERR	BIT	Uxy.00.1	Analog Output module: Channel 1 error
Input	XBF-DC04A_CH2_ERR	BIT	Uxy.00.2	Analog Output module: Channel 2 error
Input	XBF-DC04A_CH3_ERR	BIT	Uxy.00.3	Analog Output module: Channel 3 error
Input	XBF-DC04A_RDY	BIT	Uxy.00.F	Analog Output module: Module ready
Input	XBF-DC04A_CH0_ACT	BIT	Uxy.01.0	Analog Output module: CH0 RUN
Input	XBF-DC04A_CH1_ACT	BIT	Uxy.01.1	Analog Output module: CH1 RUN
Input	XBF-DC04A_CH2_ACT	BIT	Uxy.01.2	Analog Output module: CH2 RUN
Input	XBF-DC04A_CH3_ACT	BIT	Uxy.01.3	Analog Output module: CH3 RUN
Output	XBF-DC04A_CH0_OUTEN	BIT	Uxy.02.0	Analog Output module: Channel 0 output status setting
Output	XBF-DC04A_CH1_OUTEN	BIT	Uxy.02.1	Analog Output module: Channel 1 output status setting
Output	XBF-DC04A_CH2_OUTEN	BIT	Uxy.02.2	Analog Output module: Channel 2 output status setting
Output	XBF-DC04A_CH3_OUTEN	BIT	Uxy.02.3	Analog Output module: Channel 3 output status setting
Output	XBF-DC04A_CH0_DATA	Word	Uxy.03	Analog Output module: Channel 0 Input value
Output	XBF-DC04A_CH1_DATA	Word	Uxy.04	Analog Output module: Channel 1 Input value
Output	XBF-DC04A_CH2_DATA	Word	Uxy.05	Analog Output module: Channel 2 Input value
Output	XBF-DC04A_CH3_DATA	Word	Uxy.06	Analog Output module: Channel 3 Input value

2) Refresh data

<Input>

Input/Output	Variable	Type	Word(16BIT) Offset	Comment
Input	XBF-DC04A_CH0_ERR	BIT	0.0	Analog Output module: Channel 0 error
Input	XBF-DC04A_CH1_ERR	BIT	0.1	Analog Output module: Channel 1 error

Input	XBF-DC04A_CH2_ERR	BIT	0.2	Analog Output module: Channel 2 error
Input	XBF-DC04A_CH3_ERR	BIT	0.3	Analog Output module: Channel 3 error
Input	XBF-DC04A_RDY	BIT	0.F	Analog Output module: Module ready
Input	XBF-DC04A_CH0_ACT	BIT	1.0	Analog Output module: CH0 RUN
Input	XBF-DC04A_CH1_ACT	BIT	1.1	Analog Output module: CH1 RUN
Input	XBF-DC04A_CH2_ACT	BIT	1.2	Analog Output module: CH2 RUN
Input	XBF-DC04A_CH3_ACT	BIT	1.3	Analog Output module: CH3 RUN

<Output>

Input/Output	Variable	Type	Word(16BIT) Offset	Comment
Output	XBF-DC04A_CH0_OUTEN	BIT	0.0	Analog Output module: Channel 0 output status setting
Output	XBF-DC04A_CH1_OUTEN	BIT	0.1	Analog Output module: Channel 1 output status setting
Output	XBF-DC04A_CH2_OUTEN	BIT	0.2	Analog Output module: Channel 2 output status setting
Output	XBF-DC04A_CH3_OUTEN	BIT	0.3	Analog Output module: Channel 3 output status setting
Output	XBF-DC04A_CH0_DATA	Word	1	Analog Output module: Channel 0 Input value
Output	XBF-DC04A_CH1_DATA	Word	2	Analog Output module: Channel 1 Input value
Output	XBF-DC04A_CH2_DATA	Word	3	Analog Output module: Channel 2 Input value
Output	XBF-DC04A_CH3_DATA	Word	4	Analog Output module: Channel 3 Input value

(6) XBF-DC04B

1) U Device

Input/Output	Variable	Type	Device	Comment
Input	XBF-DC04B_CH0_ERR	BIT	Uxy.00.0	Analog Output module: Channel 0 error
Input	XBF-DC04B_CH1_ERR	BIT	Uxy.00.1	Analog Output module: Channel 1 error
Input	XBF-DC04B_CH2_ERR	BIT	Uxy.00.2	Analog Output module: Channel 2 error
Input	XBF-DC04B_CH3_ERR	BIT	Uxy.00.3	Analog Output module: Channel 3 error
Input	XBF-DC04B_RDY	BIT	Uxy.00.F	Analog Output module: Module ready
Input	XBF-DC04B_CH0_ACT	BIT	Uxy.01.0	Analog Output module: CH0 RUN
Input	XBF-DC04B_CH1_ACT	BIT	Uxy.01.1	Analog Output module: CH1 RUN
Input	XBF-DC04B_CH2_ACT	BIT	Uxy.01.2	Analog Output module: CH2 RUN
Input	XBF-DC04B_CH3_ACT	BIT	Uxy.01.3	Analog Output module: CH3 RUN
Output	XBF-DC04B_CH0_OUTEN	BIT	Uxy.02.0	Analog Output module: Channel 0 output status setting
Output	XBF-DC04B_CH1_OUTEN	BIT	Uxy.02.1	Analog Output module: Channel 1 output status setting
Output	XBF-DC04B_CH2_OUTEN	BIT	Uxy.02.2	Analog Output module: Channel 2 output status setting
Output	XBF-DC04B_CH3_OUTEN	BIT	Uxy.02.3	Analog Output module: Channel 3 output status setting
Output	XBF-DC04B_CH0_DATA	Word	Uxy.03	Analog Output module: Channel 0 Input value
Output	XBF-DC04B_CH1_DATA	Word	Uxy.04	Analog Output module: Channel 1 Input value
Output	XBF-DC04B_CH2_DATA	Word	Uxy.05	Analog Output module: Channel 2 Input value
Output	XBF-DC04B_CH3_DATA	Word	Uxy.06	Analog Output module: Channel 3 Input value

2) Refresh data

<Input>

Input/Output	Variable	Type	Word(16BIT) Offset	Comment
Input	XBF-DC04B_CH0_ERR	BIT	0.0	Analog Output module: Channel 0 error
Input	XBF-DC04B_CH1_ERR	BIT	0.1	Analog Output module: Channel 1 error

Appendix

Input	XBF-DC04B_CH2_ERR	BIT	0.2	Analog Output module: Channel 2 error
Input	XBF-DC04B_CH3_ERR	BIT	0.3	Analog Output module: Channel 3 error
Input	XBF-DC04B_RDY	BIT	0.F	Analog Output module: Module ready
Input	XBF-DC04B_CH0_ACT	BIT	1.0	Analog Output module: CH0 RUN
Input	XBF-DC04B_CH1_ACT	BIT	1.1	Analog Output module: CH1 RUN
Input	XBF-DC04B_CH2_ACT	BIT	1.2	Analog Output module: CH2 RUN
Input	XBF-DC04B_CH3_ACT	BIT	1.3	Analog Output module: CH3 RUN

<Output>

Input/Output	Variable	Type	Word(16BIT) Offset	Comment
Output	XBF-DC04B_CH0_OUTEN	BIT	0.0	Analog Output module: Channel 0 output status setting
Output	XBF-DC04B_CH1_OUTEN	BIT	0.1	Analog Output module: Channel 1 output status setting
Output	XBF-DC04B_CH2_OUTEN	BIT	0.2	Analog Output module: Channel 2 output status setting
Output	XBF-DC04B_CH3_OUTEN	BIT	0.3	Analog Output module: Channel 3 output status setting
Output	XBF-DC04B_CH0_DATA	Word	1	Analog Output module: Channel 0 Input value
Output	XBF-DC04B_CH1_DATA	Word	2	Analog Output module: Channel 1 Input value
Output	XBF-DC04B_CH2_DATA	Word	3	Analog Output module: Channel 2 Input value
Output	XBF-DC04B_CH3_DATA	Word	4	Analog Output module: Channel 3 Input value

(7) XBF-DC04C

1) U Device

Input/Output	Variable	Type	Device	Comment
Input	XBF-DC04C_CH0_ERR	BIT	Uxy.00.0	Analog Output module: Channel 0 error
Input	XBF-DC04C_CH1_ERR	BIT	Uxy.00.1	Analog Output module: Channel 1 error
Input	XBF-DC04C_CH2_ERR	BIT	Uxy.00.2	Analog Output module: Channel 2 error
Input	XBF-DC04C_CH3_ERR	BIT	Uxy.00.3	Analog Output module: Channel 3 error
Input	XBF-DC04C_RDY	BIT	Uxy.00.F	Analog Output module: Module ready
Input	XBF-DC04C_CH0_ACT	BIT	Uxy.01.0	Analog Output module: CH0 RUN
Input	XBF-DC04C_CH1_ACT	BIT	Uxy.01.1	Analog Output module: CH1 RUN
Input	XBF-DC04C_CH2_ACT	BIT	Uxy.01.2	Analog Output module: CH2 RUN
Input	XBF-DC04C_CH3_ACT	BIT	Uxy.01.3	Analog Output module: CH3 RUN
Input	XBF-DC04C_CH0_INTP	BIT	Uxy.01.8	Analog Output module: Channel 0 interpolation output status
Input	XBF-DC04C_CH1_INTP	BIT	Uxy.01.9	Analog Output module: Channel 1 interpolation output status
Input	XBF-DC04C_CH2_INTP	BIT	Uxy.01.A	Analog Output module: Channel 2 interpolation output status
Input	XBF-DC04C_CH3_INTP	BIT	Uxy.01.B	Analog Output module: Channel 3 interpolation output status
Input	XBF-DC04C_CH0_ODD	BIT	Uxy.01.C	Analog Output module: Channel 0 output disconnection flag
Input	XBF-DC04C_CH1_ODD	BIT	Uxy.01.D	Analog Output module: Channel 1 output disconnection flag
Input	XBF-DC04C_CH2_ODD	BIT	Uxy.01.E	Analog Output module: Channel 2 output disconnection flag
Input	XBF-DC04C_CH3_ODD	BIT	Uxy.01.F	Analog Output module: Channel 3 output disconnection flag
Output	XBF-DC04C_CH0_OUTEN	BIT	Uxy.02.0	Analog output module: Channel 0 output status setting
Output	XBF-DC04C_CH1_OUTEN	BIT	Uxy.02.1	Analog output module: Channel 1 output status setting
Output	XBF-DC04C_CH2_OUTEN	BIT	Uxy.02.2	Analog output module: Channel 2 output status setting
Output	XBF-DC04C_CH3_OUTEN	BIT	Uxy.02.3	Analog output module: Channel 3 output status setting
Output	XBF-DC04C_CH0_DATA	Word	Uxy.03	Analog output module: Channel 0 Input value
Output	XBF-DC04C_CH1_DATA	Word	Uxy.04	Analog output module: Channel 1 Input value
Output	XBF-DC04C_CH2_DATA	Word	Uxy.05	Analog output module: Channel 2 Input value
Output	XBF-DC04C_CH3_DATA	Word	Uxy.06	Analog output module: Channel 3 Input value

2) Refresh data

<Input>

Input/Output	Variable	Type	Word(16BIT) Offset	Comment
Input	XBF-DC04C_CH0_ERR	BIT	0.0	Analog Output module: Channel 0 error
Input	XBF-DC04C_CH1_ERR	BIT	0.1	Analog Output module: Channel 1 error
Input	XBF-DC04C_CH2_ERR	BIT	0.2	Analog Output module: Channel 2 error
Input	XBF-DC04C_CH3_ERR	BIT	0.3	Analog Output module: Channel 3 error
Input	XBF-DC04C_RDY	BIT	0.F	Analog output module: Module ready
Input	XBF-DC04C_CH0_ACT	BIT	1.0	Analog Output module: CH0 RUN
Input	XBF-DC04C_CH1_ACT	BIT	1.1	Analog Output module: CH1 RUN
Input	XBF-DC04C_CH2_ACT	BIT	1.2	Analog Output module: CH2 RUN
Input	XBF-DC04C_CH3_ACT	BIT	1.3	Analog Output module: CH3 RUN
Input	XBF-DC04C_CH0_INTTP	BIT	1.8	Analog Output module: Channel 0 interpolation output status
Input	XBF-DC04C_CH1_INTTP	BIT	1.9	Analog Output module: Channel 1 interpolation output status
Input	XBF-DC04C_CH2_INTTP	BIT	1.A	Analog output module: Channel 2 interpolation output status
Input	XBF-DC04C_CH3_INTTP	BIT	1.B	Analog output module: Channel 3 interpolation output status
Input	XBF-DC04C_CH0_ODD	BIT	1.C	Analog output module: Channel 0 output disconnection flag
Input	XBF-DC04C_CH1_ODD	BIT	1.D	Analog output module: Channel 1 output disconnection flag
Input	XBF-DC04C_CH2_ODD	BIT	1.E	Analog output module: Channel 2 output disconnection flag
Input	XBF-DC04C_CH3_ODD	BIT	1.F	Analog output module: Channel 3 output disconnection flag

<Output>

Input/Output	Variable	Type	Word(16BIT) Offset	Comment
Output	XBF-DC04C_CH0_OUTEN	BIT	0.0	Analog Output module: Channel 0 output status setting
Output	XBF-DC04C_CH1_OUTEN	BIT	0.1	Analog Output module: Channel 1 output status setting
Output	XBF-DC04C_CH2_OUTEN	BIT	0.2	Analog Output module: Channel 2 output status setting
Output	XBF-DC04C_CH3_OUTEN	BIT	0.3	Analog Output module: Channel 3 output status setting
Output	XBF-DC04C_CH0_DATA	Word	1	Analog Output module: Channel 0 Input value
Output	XBF-DC04C_CH1_DATA	Word	2	Analog Output module: Channel 1 Input value
Output	XBF-DC04C_CH2_DATA	Word	3	Analog Output module: Channel 2 Input value
Output	XBF-DC04C_CH3_DATA	Word	4	Analog Output module: Channel 3 Input value

(8) XBF-DV04A

1) U Device

Input/Output	Variable	Type	Device	Comment
Input	XBF-DV04A_CH0_ERR	BIT	Uxy.00.0	Analog output module: Channel 0 error
Input	XBF-DV04A_CH1_ERR	BIT	Uxy.00.1	Analog output module: Channel 1 error
Input	XBF-DV04A_CH2_ERR	BIT	Uxy.00.2	Analog output module: Channel 2 error
Input	XBF-DV04A_CH3_ERR	BIT	Uxy.00.3	Analog output module: Channel 3 error
Input	XBF-DV04A_RDY	BIT	Uxy.00.F	Analog output module: Module ready
Input	XBF-DV04A_CH0_ACT	BIT	Uxy.01.0	Analog output module: CH0 RUN
Input	XBF-DV04A_CH1_ACT	BIT	Uxy.01.1	Analog output module: CH1 RUN
Input	XBF-DV04A_CH2_ACT	BIT	Uxy.01.2	Analog output module: CH2 RUN
Input	XBF-DV04A_CH3_ACT	BIT	Uxy.01.3	Analog output module: CH3 RUN

Output	XBF-DV04A_CH0_OUTEN	BIT	Uxy.02.0	Analog output module: Channel 0 output status setting
Output	XBF-DV04A_CH1_OUTEN	BIT	Uxy.02.1	Analog output module: Channel 1 output status setting
Output	XBF-DV04A_CH2_OUTEN	BIT	Uxy.02.2	Analog output module: Channel 2 output status setting
Output	XBF-DV04A_CH3_OUTEN	BIT	Uxy.02.3	Analog output module: Channel 3 output status setting
Output	XBF-DV04A_CH0_DATA	Word	Uxy.03	Analog output module: Channel 0 Input value
Output	XBF-DV04A_CH1_DATA	Word	Uxy.04	Analog output module: Channel 1 Input value
Output	XBF-DV04A_CH2_DATA	Word	Uxy.05	Analog output module: Channel 2 Input value
Output	XBF-DV04A_CH3_DATA	Word	Uxy.06	Analog output module: Channel 3 Input value

2) Refresh data

<Input>

Input/Output	Variable	Type	Word(16BIT) Offset	Comment
Input	XBF-DV04A_CH0_ERR	BIT	0.0	Analog Output module: Channel 0 error
Input	XBF-DV04A_CH1_ERR	BIT	0.1	Analog Output module: Channel 1 error
Input	XBF-DV04A_CH2_ERR	BIT	0.2	Analog Output module: Channel 2 error
Input	XBF-DV04A_CH3_ERR	BIT	0.3	Analog Output module: Channel 3 error
Input	XBF-DV04A_RDY	BIT	0.F	Analog output module: Module ready
Input	XBF-DV04A_CH0_ACT	BIT	1.0	Analog Output module: CH0 RUN
Input	XBF-DV04A_CH1_ACT	BIT	1.1	Analog Output module: CH1 RUN
Input	XBF-DV04A_CH2_ACT	BIT	1.2	Analog Output module: CH2 RUN
Input	XBF-DV04A_CH3_ACT	BIT	1.3	Analog Output module: CH3 RUN

<Output>

Input/Output	Variable	Type	Word(16BIT) Offset	Comment
Output	XBF-DV04A_CH0_OUTEN	BIT	0.0	Analog Output module: Channel 0 output status setting
Output	XBF-DV04A_CH1_OUTEN	BIT	0.1	Analog Output module: Channel 1 output status setting
Output	XBF-DV04A_CH2_OUTEN	BIT	0.2	Analog Output module: Channel 2 output status setting
Output	XBF-DV04A_CH3_OUTEN	BIT	0.3	Analog Output module: Channel 3 output status setting
Output	XBF-DV04A_CH0_DATA	Word	1	Analog Output module: Channel 0 Input value
Output	XBF-DV04A_CH1_DATA	Word	2	Analog Output module: Channel 1 Input value
Output	XBF-DV04A_CH2_DATA	Word	3	Analog Output module: Channel 2 Input value
Output	XBF-DV04A_CH3_DATA	Word	4	Analog Output module: Channel 3 Input value

(9) XBF-DV04C

1) U Device

Input/Output	Variable	Type	Device	Comment
Input	XBF-DV04C_CH0_ERR	BIT	Uxy.00.0	Analog output module: Channel 0 error
Input	XBF-DV04C_CH1_ERR	BIT	Uxy.00.1	Analog output module: Channel 1 error
Input	XBF-DV04C_CH2_ERR	BIT	Uxy.00.2	Analog output module: Channel 2 error
Input	XBF-DV04C_CH3_ERR	BIT	Uxy.00.3	Analog output module: Channel 3 error
Input	XBF-DV04C_RDY	BIT	Uxy.00.F	Analog output module: Module ready
Input	XBF-DV04C_CH0_ACT	BIT	Uxy.01.0	Analog output module: CH0 RUN
Input	XBF-DV04C_CH1_ACT	BIT	Uxy.01.1	Analog output module: CH1 RUN
Input	XBF-DV04C_CH2_ACT	BIT	Uxy.01.2	Analog output module: CH2 RUN
Input	XBF-DV04C_CH3_ACT	BIT	Uxy.01.3	Analog output module: CH3 RUN

Input	XBF-DV04C_CH0_INTP	BIT	Uxy.01.8	Analog output module: Channel 0 interpolation output status
Input	XBF-DV04C_CH1_INTP	BIT	Uxy.01.9	Analog output module: Channel 1 interpolation output status
Input	XBF-DV04C_CH2_INTP	BIT	Uxy.01.A	Analog output module: Channel 2 interpolation output status
Input	XBF-DV04C_CH3_INTP	BIT	Uxy.01.B	Analog output module: Channel 3 interpolation output status
Output	XBF-DV04C_CH0_OUTEN	BIT	Uxy.02.0	Analog output module: Channel 0 output status setting
Output	XBF-DV04C_CH1_OUTEN	BIT	Uxy.02.1	Analog output module: Channel 1 output status setting
Output	XBF-DV04C_CH2_OUTEN	BIT	Uxy.02.2	Analog output module: Channel 2 output status setting
Output	XBF-DV04C_CH3_OUTEN	BIT	Uxy.02.3	Analog output module: Channel 3 output status setting
Output	XBF-DV04C_CH0_DATA	Word	Uxy.03	Analog output module: Channel 0 Input value
Output	XBF-DV04C_CH1_DATA	Word	Uxy.04	Analog output module: Channel 1 Input value
Output	XBF-DV04C_CH2_DATA	Word	Uxy.05	Analog output module: Channel 2 Input value
Output	XBF-DV04C_CH3_DATA	Word	Uxy.06	Analog output module: Channel 3 Input value

2) Refresh data

<Input>

Input/Output	Variable	Type	Word(16BIT) Offset	Comment
Input	XBF-DV04C_CH0_ERR	BIT	0.0	Analog Output module: Channel 0 error
Input	XBF-DV04C_CH1_ERR	BIT	0.1	Analog Output module: Channel 1 error
Input	XBF-DV04C_CH2_ERR	BIT	0.2	Analog Output module: Channel 2 error
Input	XBF-DV04C_CH3_ERR	BIT	0.3	Analog Output module: Channel 3 error
Input	XBF-DV04C_RDY	BIT	0.F	Analog output module: Module ready
Input	XBF-DV04C_CH0_ACT	BIT	1.0	Analog Output module: CH0 RUN
Input	XBF-DV04C_CH1_ACT	BIT	1.1	Analog Output module: CH1 RUN
Input	XBF-DV04C_CH2_ACT	BIT	1.2	Analog Output module: CH2 RUN
Input	XBF-DV04C_CH3_ACT	BIT	1.3	Analog Output module: CH3 RUN
Input	XBF-DV04C_CH0_INTP	BIT	1.8	Analog Output module: Channel 0 interpolation output status
Input	XBF-DV04C_CH1_INTP	BIT	1.9	Analog Output module: Channel 1 interpolation output status
Input	XBF-DV04C_CH2_INTP	BIT	1.A	Analog output module: Channel 2 interpolation output status
Input	XBF-DV04C_CH3_INTP	BIT	1.B	Analog output module: Channel 3 interpolation output status

<Output>

Input/Output	Variable	Type	Word(16BIT) Offset	Comment
Output	XBF-DV04C_CH0_OUTEN	BIT	0.0	Analog Output module: Channel 0 output status setting
Output	XBF-DV04C_CH1_OUTEN	BIT	0.1	Analog Output module: Channel 1 output status setting
Output	XBF-DV04C_CH2_OUTEN	BIT	0.2	Analog Output module: Channel 2 output status setting
Output	XBF-DV04C_CH3_OUTEN	BIT	0.3	Analog Output module: Channel 3 output status setting
Output	XBF-DV04C_CH0_DATA	Word	1	Analog Output module: Channel 0 Input value
Output	XBF-DV04C_CH1_DATA	Word	2	Analog Output module: Channel 1 Input value
Output	XBF-DV04C_CH2_DATA	Word	3	Analog Output module: Channel 2 Input value
Output	XBF-DV04C_CH3_DATA	Word	4	Analog Output module: Channel 3 Input value

(10) XBF-HD02A

1) U Device

Appendix

Input/Output	Variable	Type	Device	Comment
Input	XBF-HD02A_CH0_DN	BIT	Uxy.00.0	High Speed Counter Module: CH0 up/down counter status flag
Input	XBF-HD02A_CH0_EXTPRE	BIT	Uxy.00.1	High Speed Counter Module: Channel 0 external preset command detection flag
Input	XBF-HD02A_CH0_CRY	BIT	Uxy.00.3	High Speed Counter Module: Channel 0 carry value
Input	XBF-HD02A_CH0_BRW	BIT	Uxy.00.4	High Speed Counter Module: Channel 0 borrow value
Input	XBF-HD02A_CH0_AUXING	BIT	Uxy.00.5	High Speed Counter Module: Channel 0 auxiliary function status
Input	XBF-HD02A_CH0_CMPOUT0	BIT	Uxy.00.6	High Speed Counter Module: Channel 0 compare output 0 status
Input	XBF-HD02A_CH0_CMPOUT1	BIT	Uxy.00.7	High Speed Counter Module: Channel 0 compare output 1 status
Input	XBF-HD02A_CH0_ERR	BIT	Uxy.00.E	High Speed Counter Module: Channel 0 error flag
Input	XBF-HD02A_RDY	BIT	Uxy.00.F	High Speed Counter Module: Module ready
Input	XBF-HD02A_CH1_DN	BIT	Uxy.01.0	High Speed Counter Module: CH1 up/down counter status flag
Input	XBF-HD02A_CH1_EXTPRE	BIT	Uxy.01.1	High Speed Counter Module: Channel 1 external preset command detection flag
Input	XBF-HD02A_CH1_CRY	BIT	Uxy.01.3	High Speed Counter Module: Channel 1 carry value
Input	XBF-HD02A_CH1_BRW	BIT	Uxy.01.4	High Speed Counter Module: Channel 1 borrow value
Input	XBF-HD02A_CH1_AUXING	BIT	Uxy.01.5	High Speed Counter Module: Channel 1 auxiliary function status
Input	XBF-HD02A_CH1_CMPOUT0	BIT	Uxy.01.6	High Speed Counter Module: Channel 1 compare output 0 status
Input	XBF-HD02A_CH1_CMPOUT1	BIT	Uxy.01.7	High Speed Counter Module: Channel 1 compare output 1 status
Input	XBF-HD02A_CH1_ERR	BIT	Uxy.01.E	High Speed Counter Module: Channel 1 error flag
Output	XBF-HD02A_CH0_CNTEN	BIT	Uxy.23.0	High Speed Counter Module: Channel 0 enable counter command(level)
Output	XBF-HD02A_CH0_PREEN	BIT	Uxy.23.1	High Speed Counter Module: Channel 0 enable preset command(Edge)
Output	XBF-HD02A_CH0_DWNCNT	BIT	Uxy.23.2	High Speed Counter Module: Channel 0 up/down counter select command(Level)
Output	XBF-HD02A_CH0_AUXEN	BIT	Uxy.23.3	High Speed Counter Module: Channel 0 auxiliary function request(Edge,Level)
Output	XBF-HD02A_CH0_CMPEN	BIT	Uxy.23.4	High Speed Counter Module: Channel 0 compare function enable command(Level)
Output	XBF-HD02A_CH0_OUTEN	BIT	Uxy.23.5	High Speed Counter Module: Channel 0 compare output signal enable command(Level)
Output	XBF-HD02A_CH0_EQ0RST	BIT	Uxy.23.6	High Speed Counter Module: Channel 0 compare output 0 equal reset command (Edge)
Output	XBF-HD02A_CH0_EQ1RST	BIT	Uxy.23.7	High Speed Counter Module: Channel 0 compare output 1 equal reset command (Edge)
Output	XBF-HD02A_CH0_CRYBRW_RST	BIT	Uxy.23.A	High Speed Counter Module: Channel 0 carry/borrow reset command(Edge)
Output	XBF-HD02A_CH0_EXTPST_EN	BIT	Uxy.23.B	High Speed Counter Module: Channel 0 preset Ext. Input enable command
Output	XBF-HD02A_CH0_EXTAUX_EN	BIT	Uxy.23.C	High Speed Counter Module: Channel 0 auxiliary function Ext.

				input enable command
Output	XBF-HD02A_CH0_EXTPST_RST	BIT	Uxy.23.D	High Speed Counter Module: Channel 0 Ext. Input preset reset command
Output	XBF-HD02A_CH1_CNTEN	BIT	Uxy.24.0	High Speed Counter Module: Channel 1 enable counter command(level)
Output	XBF-HD02A_CH1_PREEN	BIT	Uxy.24.1	High Speed Counter Module: Channel 1 enable preset command(Edge)
Output	XBF-HD02A_CH1_DWNCNT	BIT	Uxy.24.2	High Speed Counter Module: Channel 1 up/down counter select command(Level)
Output	XBF-HD02A_CH1_AUXEN	BIT	Uxy.24.3	High Speed Counter Module: Channel 1 auxiliary function enable command(Edge,Level)
Output	XBF-HD02A_CH1_CMPEN	BIT	Uxy.24.4	High Speed Counter Module: Channel 1 compare function enable command(Level)
Output	XBF-HD02A_CH1_OUTEN	BIT	Uxy.24.5	High Speed Counter Module: Channel 1 compare output signal enable command(Level)
Output	XBF-HD02A_CH1_EQ0RST	BIT	Uxy.24.6	High Speed Counter Module: Channel 0 compare output 0 equal reset command (Edge)
Output	XBF-HD02A_CH1_EQ1RST	BIT	Uxy.24.7	High Speed Counter Module: Channel 1 compare output 1 equal reset command (Edge)
Output	XBF-HD02A_CH1_CRYBRW_RST	BIT	Uxy.24.A	High Speed Counter Module: Channel 1 carry/borrow reset command(Edge)
Output	XBF-HD02A_CH1_EXTPST_EN	BIT	Uxy.24.B	High Speed Counter Module: Channel 1 preset Ext. Input enable command
Output	XBF-HD02A_CH1_EXT AUX_EN	BIT	Uxy.24.C	High Speed Counter Module: Channel 1 auxiliary Ext. Input enable command
Output	XBF-HD02A_CH1_EXTPST_RST	BIT	Uxy.24.D	High Speed Counter Module: Channel 1 Ext. Input preset reset command
Input	XBF-HD02A_CH0_CNT_LV	Word	Uxy.02	High Speed Counter Module: Channel 0 count value (LWORD)
Input	XBF-HD02A_CH0_CNT_HV	Word	Uxy.03	High Speed Counter Module: Channel 0 count value (HWORD)
Input	XBF-HD02A_CH0_LTH_LV	Word	Uxy.04	High Speed Counter Module: Channel 0 latch count value (LWORD)
Input	XBF-HD02A_CH0_LTH_HV	Word	Uxy.05	High Speed Counter Module: Channel 0 latch count value (HWORD)
Input	XBF-HD02A_CH0_RNG_LV	Word	Uxy.06	High Speed Counter Module: Channel 0 sampling count value (LWORD)
Input	XBF-HD02A_CH0_RNG_HV	Word	Uxy.07	High Speed Counter Module: Channel 0 sampling count value (HWORD)
Input	XBF-HD02A_CH0_FRQ_LV	Word	Uxy.08	High Speed Counter Module: Channel 0 input frequency value (LWORD)
Input	XBF-HD02A_CH0_FRQ_HV	Word	Uxy.09	High Speed Counter Module: Channel 0 input frequency value (HWORD)
Input	XBF-HD02A_CH0_RPU_LV	Word	Uxy.10	High Speed Counter Module: Channel 0 Rev./unit time value (LWORD)
Input	XBF-HD02A_CH0_RPU_HV	Word	Uxy.11	High Speed Counter Module: Channel 0 Rev./unit time value (HWORD)
Input	XBF-HD02A_CH1_CNT_LV	Word	Uxy.12	High Speed Counter Module: Channel 1 count value (LWORD)

Appendix

Input	XBF-HD02A_CH1_CNT_HV	Word	Uxy.13	High Speed Counter Module: Channel 1 count value (HWORD)
Input	XBF-HD02A_CH1_LTH_LV	Word	Uxy.14	High Speed Counter Module: Channel 1 latch count value (LWORD)
Input	XBF-HD02A_CH1_LTH_HV	Word	Uxy.15	High Speed Counter Module: Channel 1 latch count value (HWORD)
Input	XBF-HD02A_CH1_RNG_LV	Word	Uxy.16	High Speed Counter Module: Channel 1 sampling count value (LWORD)
Input	XBF-HD02A_CH1_RNG_HV	Word	Uxy.17	High Speed Counter Module: Channel 1 sampling count value (HWORD)
Input	XBF-HD02A_CH1_FRQ_LV	Word	Uxy.18	High Speed Counter Module: Channel 1 input frequency value (LWORD)
Input	XBF-HD02A_CH1_FRQ_HV	Word	Uxy.19	High Speed Counter Module: Channel 1 input frequency value (HWORD)
Input	XBF-HD02A_CH1_RPU_LV	Word	Uxy.20	High Speed Counter Module: Channel 1 Rev./unit time value (LWORD)
Input	XBF-HD02A_CH1_RPU_HV	Word	Uxy.21	High Speed Counter Module: Channel 1 Rev./unit time value (HWORD)

2) Refresh data

<Input>

Input/Output	Variable	Type	Word(16BIT) Offset	Comment
Input	XBF-HD02A_CH0_DN	BIT	0.0	High Speed Counter Module: CH0 up/down counter status flag
Input	XBF-HD02A_CH0_EXTPRE	BIT	0.1	High Speed Counter Module: Channel 0 external preset command detection flag
Input	XBF-HD02A_CH0_CRY	BIT	0.3	High Speed Counter Module: Channel 0 carry value
Input	XBF-HD02A_CH0_BRW	BIT	0.4	High Speed Counter Module: Channel 0 borrow value
Input	XBF-HD02A_CH0_AUXING	BIT	0.5	High Speed Counter Module: Channel 0 auxiliary function status
Input	XBF-HD02A_CH0_CMPOUT0	BIT	0.6	High Speed Counter Module: Channel 0 compare output 0 status
Input	XBF-HD02A_CH0_CMPOUT1	BIT	0.7	High Speed Counter Module: Channel 0 compare output 1 status
Input	XBF-HD02A_CH0_ERR	BIT	0.E	High Speed Counter Module: Channel 0 error flag
Input	XBF-HD02A_RDY	BIT	0.F	High Speed Counter Module: Module ready
Input	XBF-HD02A_CH1_DN	BIT	1.0	High Speed Counter Module: CH1 up/down counter status flag
Input	XBF-HD02A_CH1_EXTPRE	BIT	1.1	High Speed Counter Module: Channel 1 external preset command detection flag
Input	XBF-HD02A_CH1_CRY	BIT	1.3	High Speed Counter Module: Channel 1 carry value
Input	XBF-HD02A_CH1_BRW	BIT	1.4	High Speed Counter Module: Channel 1 borrow value
Input	XBF-HD02A_CH1_AUXING	BIT	1.5	High Speed Counter Module: Channel 1 auxiliary function status
Input	XBF-HD02A_CH1_CMPOUT0	BIT	1.6	High Speed Counter Module: Channel 1 compare output 0 status
Input	XBF-	BIT	1.7	High Speed Counter Module: Channel 1 compare output 1

	HD02A_CH1_CMPOUT1			status
Input	XBF-HD02A_CH1_ERR	BIT	1.E	High Speed Counter Module: Channel 1 error flag
Input	XBF-HD02A_CH0_CNT_LV	Word	2	High Speed Counter Module: Channel 0 count value (LWORD)
Input	XBF-HD02A_CH0_CNT_HV	Word	3	High Speed Counter Module: Channel 0 count value (HWORD)
Input	XBF-HD02A_CH0_LTH_LV	Word	4	High Speed Counter Module: Channel 0 latch count value (LWORD)
Input	XBF-HD02A_CH0_LTH_HV	Word	5	High Speed Counter Module: Channel 0 latch count value (HWORD)
Input	XBF-HD02A_CH0_RNG_LV	Word	6	High Speed Counter Module: Channel 0 sampling count value (LWORD)
Input	XBF-HD02A_CH0_RNG_HV	Word	7	High Speed Counter Module: Channel 0 sampling count value (HWORD)
Input	XBF-HD02A_CH0_FRQ_LV	Word	8	High Speed Counter Module: Channel 0 input frequency value (LWORD)
Input	XBF-HD02A_CH0_FRQ_HV	Word	9	High Speed Counter Module: Channel 0 input frequency value (HWORD)
Input	XBF-HD02A_CH0_RPU_LV	Word	10	High Speed Counter Module: Channel 0 Rev./unit time value (LWORD)
Input	XBF-HD02A_CH0_RPU_HV	Word	11	High Speed Counter Module: Channel 0 Rev./unit time value (HWORD)
Input	XBF-HD02A_CH1_CNT_LV	Word	12	High Speed Counter Module: Channel 1 count value (LWORD)
Input	XBF-HD02A_CH1_CNT_HV	Word	13	High Speed Counter Module: Channel 1 count value (HWORD)
Input	XBF-HD02A_CH1_LTH_LV	Word	14	High Speed Counter Module: Channel 1 latch count value (LWORD)
Input	XBF-HD02A_CH1_LTH_HV	Word	15	High Speed Counter Module: Channel 1 latch count value (HWORD)
Input	XBF-HD02A_CH1_RNG_LV	Word	16	High Speed Counter Module: Channel 1 sampling count value (LWORD)
Input	XBF-HD02A_CH1_RNG_HV	Word	17	High Speed Counter Module: Channel 1 sampling count value (HWORD)
Input	XBF-HD02A_CH1_FRQ_LV	Word	18	High Speed Counter Module: Channel 1 input frequency value (LWORD)
Input	XBF-HD02A_CH1_FRQ_HV	Word	19	High Speed Counter Module: Channel 1 input frequency value (HWORD)
Input	XBF-HD02A_CH1_RPU_LV	Word	20	High Speed Counter Module: Channel 1 Rev./unit time value (LWORD)
Input	XBF-HD02A_CH1_RPU_HV	Word	21	High Speed Counter Module: Channel 1 Rev./unit time value (HWORD)

<Output>

Input/Output	Variable	Type	Word(16BIT) Offset	Comment
Output	XBF-HD02A_CH0_CNTEN	BIT	0.0	High Speed Counter Module: Channel 0 enable counter command(level)
Output	XBF-HD02A_CH0_PREEN	BIT	0.1	High Speed Counter Module: Channel 0 enable preset command(Edge)

Appendix

Output	XBF-HD02A_CH0_DWNCNT	BIT	0.2	High Speed Counter Module: Channel 0 up/down counter select command(Level)
Output	XBF-HD02A_CH0_AUXEN	BIT	0.3	High Speed Counter Module: Channel 0 auxiliary function request(Edge,Level)
Output	XBF-HD02A_CH0_CMPEN	BIT	0.4	High Speed Counter Module: Channel 0 compare function enable command(Level)
Output	XBF-HD02A_CH0_OUTEN	BIT	0.5	High Speed Counter Module: Channel 0 compare output signal enable command(Level)
Output	XBF-HD02A_CH0_EQ0RST	BIT	0.6	High Speed Counter Module: Channel 0 compare output 0 equal reset command (Edge)
Output	XBF-HD02A_CH0_EQ1RST	BIT	0.7	High Speed Counter Module: Channel 0 compare output 1 equal reset command (Edge)
Output	XBF-HD02A_CH0_CRYBRW_RST	BIT	0.A	High Speed Counter Module: Channel 0 carry/borrow reset command(Edge)
Output	XBF-HD02A_CH0_EXTPST_EN	BIT	0.B	High Speed Counter Module: Channel 0 preset Ext. Input enable command
Output	XBF-HD02A_CH0_EXTAUX_EN	BIT	0.C	High Speed Counter Module: Channel 0 auxiliary function Ext. input enable command
Output	XBF-HD02A_CH0_EXTPST_RST	BIT	0.D	High Speed Counter Module: Channel 0 Ext. Input preset reset command
Output	XBF-HD02A_CH1_CNTEN	BIT	1.0	High Speed Counter Module: Channel 1 enable counter command(level)
Output	XBF-HD02A_CH1_PREEN	BIT	1.1	High Speed Counter Module: Channel 1 enable preset command(Edge)
Output	XBF-HD02A_CH1_DWNCNT	BIT	1.2	High Speed Counter Module: Channel 1 up/down counter select command(Level)
Output	XBF-HD02A_CH1_AUXEN	BIT	1.3	High Speed Counter Module: Channel 1 auxiliary function enable command(Edge level)
Output	XBF-HD02A_CH1_CMPEN	BIT	1.4	High Speed Counter Module: Channel 1 compare function enable command(Level)
Output	XBF-HD02A_CH1_OUTEN	BIT	1.5	High Speed Counter Module: Channel 1 compare output signal enable command(Level)
Output	XBF-HD02A_CH1_EQ0RST	BIT	1.6	High Speed Counter Module: Channel 0 compare output 0 equal reset command (Edge)
Output	XBF-HD02A_CH1_EQ1RST	BIT	1.7	High Speed Counter Module: Channel 1 compare output 1 equal reset command (Edge)
Output	XBF-HD02A_CH1_CRYBRW_RST	BIT	1.A	High Speed Counter Module: Channel 1 carry/borrow reset command(Edge)
Output	XBF-HD02A_CH1_EXTPST_EN	BIT	1.B	High Speed Counter Module: Channel 1 preset Ext. Input enable command
Output	XBF-HD02A_CH1_EXTAUX_EN	BIT	1.C	High Speed Counter Module: Channel 1 auxiliary Ext. Input enable command
Output	XBF-HD02A_CH1_EXTPST_RST	BIT	1.D	High Speed Counter Module: Channel 1 Ext. Input preset reset command

(11) XBF-HO02A

1) U Device

Input/Output	Variable	Type	Device	Comment
--------------	----------	------	--------	---------

Input	XBF-HO02A_CH0_DN	BIT	Uxy.00.0	High Speed Counter Module: CH0 up/down counter status flag
Input	XBF-HO02A_CH0_EXTPRE	BIT	Uxy.00.1	High Speed Counter Module: Channel 0 external preset command detection flag
Input	XBF-HO02A_CH0_CRY	BIT	Uxy.00.3	High Speed Counter Module: Channel 0 carry value
Input	XBF-HO02A_CH0_BRW	BIT	Uxy.00.4	High Speed Counter Module: Channel 0 borrow value
Input	XBF-HO02A_CH0_AUXING	BIT	Uxy.00.5	High Speed Counter Module: Channel 0 auxiliary function status
Input	XBF-HO02A_CH0_CMPOUT0	BIT	Uxy.00.6	High Speed Counter Module: Channel 0 compare output 0 status
Input	XBF-HO02A_CH0_CMPOUT1	BIT	Uxy.00.7	High Speed Counter Module: Channel 0 compare output 1 status
Input	XBF-HO02A_CH0_ERR	BIT	Uxy.00.E	High Speed Counter Module: Channel 0 error flag
Input	XBF-HO02A_RDY	BIT	Uxy.00.F	High Speed Counter Module: Module ready
Input	XBF-HO02A_CH1_DN	BIT	Uxy.01.0	High Speed Counter Module: CH1 up/down counter status flag
Input	XBF-HO02A_CH1_EXTPRE	BIT	Uxy.01.1	High Speed Counter Module: Channel 1 external preset command detection flag
Input	XBF-HO02A_CH1_CRY	BIT	Uxy.01.3	High Speed Counter Module: Channel 1 carry value
Input	XBF-HO02A_CH1_BRW	BIT	Uxy.01.4	High Speed Counter Module: Channel 1 borrow value
Input	XBF-HO02A_CH1_AUXING	BIT	Uxy.01.5	High Speed Counter Module: Channel 1 auxiliary function status
Input	XBF-HO02A_CH1_CMPOUT0	BIT	Uxy.01.6	High Speed Counter Module: Channel 1 compare output 0 status
Input	XBF-HO02A_CH1_CMPOUT1	BIT	Uxy.01.7	High Speed Counter Module: Channel 1 compare output 1 status
Input	XBF-HO02A_CH1_ERR	BIT	Uxy.01.E	High Speed Counter Module: Channel 1 error flag
Output	XBF-HO02A_CH0_CNTEN	BIT	Uxy.23.0	High Speed Counter Module: Channel 0 enable counter command(level)
Output	XBF-HO02A_CH0_PREEN	BIT	Uxy.23.1	High Speed Counter Module: Channel 0 enable preset command(Edge)
Output	XBF-HO02A_CH0_DWNCNT	BIT	Uxy.23.2	High Speed Counter Module: Channel 0 up/down counter select command(Level)
Output	XBF-HO02A_CH0_AUXEN	BIT	Uxy.23.3	High Speed Counter Module: Channel 0 auxiliary function request(Edge,Level)
Output	XBF-HO02A_CH0_CMPEN	BIT	Uxy.23.4	High Speed Counter Module: Channel 0 compare function enable command(Level)
Output	XBF-HO02A_CH0_OUTEN	BIT	Uxy.23.5	High Speed Counter Module: Channel 0 compare output signal enable command(Level)
Output	XBF-HO02A_CH0_EQ0RST	BIT	Uxy.23.6	High Speed Counter Module: Channel 0 compare output 0 equal reset command (Edge)
Output	XBF-HO02A_CH0_EQ1RST	BIT	Uxy.23.7	High Speed Counter Module: Channel 0 compare output 1 equal reset command (Edge)
Output	XBF-HO02A_CH0_CRYBRW_RST	BIT	Uxy.23.A	High Speed Counter Module: Channel 0 carry/borrow reset command(Edge)
Output	XBF-HO02A_CH0_EXTPST_EN	BIT	Uxy.23.B	High Speed Counter Module: Channel 0 preset Ext. Input enable command
Output	XBF-HO02A_CH0_EXTAUX_EN	BIT	Uxy.23.C	High Speed Counter Module: Channel 0 auxiliary function Ext. input enable command

Appendix

Output	XBF-HO02A_CH0_EXTPST_RST	BIT	Uxy.23.D	High Speed Counter Module: Channel 0 Ext. Input preset reset command
Output	XBF-HO02A_CH1_CNTEN	BIT	Uxy.24.0	High Speed Counter Module: Channel 1 enable counter command(level)
Output	XBF-HO02A_CH1_PREEN	BIT	Uxy.24.1	High Speed Counter Module: Channel 1 enable preset command(Edge)
Output	XBF-HO02A_CH1_DWNCNT	BIT	Uxy.24.2	High Speed Counter Module: Channel 1 up/down counter select command(Level)
Output	XBF-HO02A_CH1_AUXEN	BIT	Uxy.24.3	High Speed Counter Module: Channel 1 auxiliary function enable command(Edge,Level)
Output	XBF-HO02A_CH1_CMPEN	BIT	Uxy.24.4	High Speed Counter Module: Channel 1 compare function enable command(Level)
Output	XBF-HO02A_CH1_OUTEN	BIT	Uxy.24.5	High Speed Counter Module: Channel 1 compare output signal enable command(Level)
Output	XBF-HO02A_CH1_EQ0RST	BIT	Uxy.24.6	High Speed Counter Module: Channel 0 compare output 0 equal reset command (Edge)
Output	XBF-HO02A_CH1_EQ1RST	BIT	Uxy.24.7	High Speed Counter Module: Channel 1 compare output 1 equal reset command (Edge)
Output	XBF-HO02A_CH1_CRYBRW_RST	BIT	Uxy.24.A	High Speed Counter Module: Channel 1 carry/borrow reset command(Edge)
Output	XBF-HO02A_CH1_EXTPST_EN	BIT	Uxy.24.B	High Speed Counter Module: Channel 1 preset Ext. Input enable command
Output	XBF-HO02A_CH1_EXT AUX_EN	BIT	Uxy.24.C	High Speed Counter Module: Channel 1 auxiliary Ext. Input enable command
Output	XBF-HO02A_CH1_EXTPST_RST	BIT	Uxy.24.D	High Speed Counter Module: Channel 1 Ext. Input preset reset command
Input	XBF-HO02A_CH0_CNT_LV	Word	Uxy.02	High Speed Counter Module: Channel 0 count value (LWORD)
Input	XBF-HO02A_CH0_CNT_HV	Word	Uxy.03	High Speed Counter Module: Channel 0 count value (HWORD)
Input	XBF-HO02A_CH0_LTH_LV	Word	Uxy.04	High Speed Counter Module: Channel 0 latch count value (LWORD)
Input	XBF-HO02A_CH0_LTH_HV	Word	Uxy.05	High Speed Counter Module: Channel 0 latch count value (HWORD)
Input	XBF-HO02A_CH0_RNG_LV	Word	Uxy.06	High Speed Counter Module: Channel 0 sampling count value (LWORD)
Input	XBF-HO02A_CH0_RNG_HV	Word	Uxy.07	High Speed Counter Module: Channel 0 sampling count value (HWORD)
Input	XBF-HO02A_CH0_FRQ_LV	Word	Uxy.08	High Speed Counter Module: Channel 0 input frequency value (LWORD)
Input	XBF-HO02A_CH0_FRQ_HV	Word	Uxy.09	High Speed Counter Module: Channel 0 input frequency value (HWORD)
Input	XBF-HO02A_CH0_RPU_LV	Word	Uxy.10	High Speed Counter Module: Channel 0 Rev./unit time value (LWORD)
Input	XBF-HO02A_CH0_RPU_HV	Word	Uxy.11	High Speed Counter Module: Channel 0 Rev./unit time value (HWORD)
Input	XBF-HO02A_CH1_CNT_LV	Word	Uxy.12	High Speed Counter Module: Channel 1 count value (LWORD)
Input	XBF-HO02A_CH1_CNT_HV	Word	Uxy.13	High Speed Counter Module: Channel 1 count value

				(HWORD)
Input	XBF-HO02A_CH1_LTH_LV	Word	Uxy.14	High Speed Counter Module: Channel 1 latch count value (LWORD)
Input	XBF-HO02A_CH1_LTH_HV	Word	Uxy.15	High Speed Counter Module: Channel 1 latch count value (HWORD)
Input	XBF-HO02A_CH1_RNG_LV	Word	Uxy.16	High Speed Counter Module: Channel 1 sampling count value (LWORD)
Input	XBF-HO02A_CH1_RNG_HV	Word	Uxy.17	High Speed Counter Module: Channel 1 sampling count value (HWORD)
Input	XBF-HO02A_CH1_FRQ_LV	Word	Uxy.18	High Speed Counter Module: Channel 1 input frequency value (LWORD)
Input	XBF-HO02A_CH1_FRQ_HV	Word	Uxy.19	High Speed Counter Module: Channel 1 input frequency value (HWORD)
Input	XBF-HO02A_CH1_RPU_LV	Word	Uxy.20	High Speed Counter Module: Channel 1 Rev./unit time value (LWORD)
Input	XBF-HO02A_CH1_RPU_HV	Word	Uxy.21	High Speed Counter Module: Channel 1 Rev./unit time value (HWORD)

2) Refresh data

<Input>

Input/Output	Variable	Type	Word(16BIT) Offset	Comment
Input	XBF-HO02A_CH0_DN	BIT	0.0	High Speed Counter Module: CH0 up/down counter status flag
Input	XBF-HO02A_CH0_EXTPRE	BIT	0.1	High Speed Counter Module: Channel 0 external preset command detection flag
Input	XBF-HO02A_CH0_CRY	BIT	0.3	High Speed Counter Module: Channel 0 carry value
Input	XBF-HO02A_CH0_BRW	BIT	0.4	High Speed Counter Module: Channel 0 borrow value
Input	XBF-HO02A_CH0_AUXING	BIT	0.5	High Speed Counter Module: Channel 0 auxiliary function status
Input	XBF-HO02A_CH0_CMPOUT0	BIT	0.6	High Speed Counter Module: Channel 0 compare output 0 status
Input	XBF-HO02A_CH0_CMPOUT1	BIT	0.7	High Speed Counter Module: Channel 0 compare output 1 status
Input	XBF-HO02A_CH0_ERR	BIT	0.E	High Speed Counter Module: Channel 0 error flag
Input	XBF-HO02A_RDY	BIT	0.F	High Speed Counter Module: Module ready
Input	XBF-HO02A_CH1_DN	BIT	1.0	High Speed Counter Module: CH1 up/down counter status flag
Input	XBF-HO02A_CH1_EXTPRE	BIT	1.1	High Speed Counter Module: Channel 1 external preset command detection flag
Input	XBF-HO02A_CH1_CRY	BIT	1.3	High Speed Counter Module: Channel 1 carry value
Input	XBF-HO02A_CH1_BRW	BIT	1.4	High Speed Counter Module: Channel 1 borrow value
Input	XBF-HO02A_CH1_AUXING	BIT	1.5	High Speed Counter Module: Channel 1 auxiliary function status
Input	XBF-HO02A_CH1_CMPOUT0	BIT	1.6	High Speed Counter Module: Channel 1 compare output 0 status
Input	XBF-HO02A_CH1_CMPOUT1	BIT	1.7	High Speed Counter Module: Channel 1 compare output 1 status

Appendix

Input	XBF-HO02A_CH1_ERR	BIT	1.E	High Speed Counter Module: Channel 1 error flag
Input	XBF-HO02A_CH0_CNT_LV	Word	2	High Speed Counter Module: Channel 0 count value (LWORD)
Input	XBF-HO02A_CH0_CNT_HV	Word	3	High Speed Counter Module: Channel 0 count value (HWORD)
Input	XBF-HO02A_CH0_LTH_LV	Word	4	High Speed Counter Module: Channel 0 latch count value (LWORD)
Input	XBF-HO02A_CH0_LTH_HV	Word	5	High Speed Counter Module: Channel 0 latch count value (HWORD)
Input	XBF-HO02A_CH0_RNG_LV	Word	6	High Speed Counter Module: Channel 0 sampling count value (LWORD)
Input	XBF-HO02A_CH0_RNG_HV	Word	7	High Speed Counter Module: Channel 0 sampling count value (HWORD)
Input	XBF-HO02A_CH0_FRQ_LV	Word	8	High Speed Counter Module: Channel 0 input frequency value (LWORD)
Input	XBF-HO02A_CH0_FRQ_HV	Word	9	High Speed Counter Module: Channel 0 input frequency value (HWORD)
Input	XBF-HO02A_CH0_RPU_LV	Word	10	High Speed Counter Module: Channel 0 Rev./unit time value (LWORD)
Input	XBF-HO02A_CH0_RPU_HV	Word	11	High Speed Counter Module: Channel 0 Rev./unit time value (HWORD)
Input	XBF-HO02A_CH1_CNT_LV	Word	12	High Speed Counter Module: Channel 1 count value (LWORD)
Input	XBF-HO02A_CH1_CNT_HV	Word	13	High Speed Counter Module: Channel 1 count value (HWORD)
Input	XBF-HO02A_CH1_LTH_LV	Word	14	High Speed Counter Module: Channel 1 latch count value (LWORD)
Input	XBF-HO02A_CH1_LTH_HV	Word	15	High Speed Counter Module: Channel 1 latch count value (HWORD)
Input	XBF-HO02A_CH1_RNG_LV	Word	16	High Speed Counter Module: Channel 1 sampling count value (LWORD)
Input	XBF-HO02A_CH1_RNG_HV	Word	17	High Speed Counter Module: Channel 1 sampling count value (HWORD)
Input	XBF-HO02A_CH1_FRQ_LV	Word	18	High Speed Counter Module: Channel 1 input frequency value (LWORD)
Input	XBF-HO02A_CH1_FRQ_HV	Word	19	High Speed Counter Module: Channel 1 input frequency value (HWORD)
Input	XBF-HO02A_CH1_RPU_LV	Word	20	High Speed Counter Module: Channel 1 Rev./unit time value (LWORD)
Input	XBF-HO02A_CH1_RPU_HV	Word	21	High Speed Counter Module: Channel 1 Rev./unit time value (HWORD)

<Output>

Input/Output	Variable	Type	Word(16BIT) Offset	Comment
Output	XBF-HO02A_CH0_CNTEN	BIT	0.0	High Speed Counter Module: Channel 0 enable counter command(level)
Output	XBF-HO02A_CH0_PREEN	BIT	0.1	High Speed Counter Module: Channel 0 enable preset command(Edge)
Output	XBF-HO02A_CH0_DWNCNT	BIT	0.2	High Speed Counter Module: Channel 0 up/down counter

				select command(Level)
Output	XBF-HO02A_CH0_AUXEN	BIT	0.3	High Speed Counter Module: Channel 0 auxiliary function request(Edge,Level)
Output	XBF-HO02A_CH0_CMPEN	BIT	0.4	High Speed Counter Module: Channel 0 compare function enable command(Level)
Output	XBF-HO02A_CH0_OUTEN	BIT	0.5	High Speed Counter Module: Channel 0 compare output signal enable command(Level)
Output	XBF-HO02A_CH0_EQ0RST	BIT	0.6	High Speed Counter Module: Channel 0 compare output 0 equal reset command (Edge)
Output	XBF-HO02A_CH0_EQ1RST	BIT	0.7	High Speed Counter Module: Channel 0 compare output 1 equal reset command (Edge)
Output	XBF-HO02A_CH0_CRYBRW_RST	BIT	0.A	High Speed Counter Module: Channel 0 carry/borrow reset command(Edge)
Output	XBF-HO02A_CH0_EXTPST_EN	BIT	0.B	High Speed Counter Module: Channel 0 preset Ext. Input enable command
Output	XBF-HO02A_CH0_EXTAUX_EN	BIT	0.C	High Speed Counter Module: Channel 0 auxiliary function Ext. input enable command
Output	XBF-HO02A_CH0_EXTPST_RST	BIT	0.D	High Speed Counter Module: Channel 0 Ext. Input preset reset command
Output	XBF-HO02A_CH1_CNTEN	BIT	1.0	High Speed Counter Module: Channel 1 enable counter command(level)
Output	XBF-HO02A_CH1_PREEN	BIT	1.1	High Speed Counter Module: Channel 1 enable preset command(Edge)
Output	XBF-HO02A_CH1_DWNCNT	BIT	1.2	High Speed Counter Module: Channel 1 up/down counter select command(Level)
Output	XBF-HO02A_CH1_AUXEN	BIT	1.3	High Speed Counter Module: Channel 1 auxiliary function enable command(Edge,Level)
Output	XBF-HO02A_CH1_CMPEN	BIT	1.4	High Speed Counter Module: Channel 1 compare function enable command(Level)
Output	XBF-HO02A_CH1_OUTEN	BIT	1.5	High Speed Counter Module: Channel 1 compare output signal enable command(Level)
Output	XBF-HO02A_CH1_EQ0RST	BIT	1.6	High Speed Counter Module: Channel 0 compare output 0 equal reset command (Edge)
Output	XBF-HO02A_CH1_EQ1RST	BIT	1.7	High Speed Counter Module: Channel 1 compare output 1 equal reset command (Edge)
Output	XBF-HO02A_CH1_CRYBRW_RST	BIT	1.A	High Speed Counter Module: Channel 1 carry/borrow reset command(Edge)
Output	XBF-HO02A_CH1_EXTPST_EN	BIT	1.B	High Speed Counter Module: Channel 1 preset Ext. Input enable command
Output	XBF-HO02A_CH1_EXTAUX_EN	BIT	1.C	High Speed Counter Module: Channel 1 auxiliary Ext. Input enable command
Output	XBF-HO02A_CH1_EXTPST_RST	BIT	1.D	High Speed Counter Module: Channel 1 Ext. Input preset reset command

(12) XBF-RD01A

1) U Device

Input/Output	Variable	Type	Device	Comment
Input	XBF-RD01A_ERR	BIT	Uxy.00.0	Temperature input module : Module error

Appendix

Input	XBF-RD01A_RDY	BIT	Uxy.00.F	Temperature	input module : Module ready
Input	XBF-RD01A_CH0_ACT	BIT	Uxy.01.0	Temperature	input module : Channel 0 RUN
Input	XBF-RD01A_CH0_BOUT	BIT	Uxy.01.4	Temperature	input module : Channel 0 disconnection
Input	XBF-RD01A_CH0_TEMP	Word	Uxy.04	Temperature	input module : Channel 0 temperature data
Input	XBF-RD01A_CH0_SCAL	Word	Uxy.08	Temperature	input module : Channel 0 scaling data

2) Refresh data

<Input>

Input/Output	Variable	Type	Word(16BIT) Offset	Comment
Input	XBF-RD01A_ERR	BIT	0.0	Temperature input module : Module error
Input	XBF-RD01A_RDY	BIT	0.F	Temperature input module : Module ready
Input	XBF-RD01A_CH0_ACT	BIT	1.0	Temperature input module : Channel 0 RUN
Input	XBF-RD01A_CH0_BOUT	BIT	1.4	Temperature input module : Channel 0 disconnection
Input		WORD	2	Reserved
Input		WORD	3	Reserved
Input	XBF-RD01A_CH0_TEMP	Word	4	Temperature input module : Channel 0 temperature data
Input		WORD	5	Reserved
Input		WORD	6	Reserved
Input		WORD	7	Reserved
Input	XBF-RD01A_CH0_SCAL	Word	8	Temperature input module : Channel 0 scaling data
Input		WORD	9	Reserved
Input		WORD	10	Reserved
Input		WORD	11	Reserved

(13) XBF-RD04A

1) U Device

Input/Output	Variable	Type	Device	Comment
Input	XBF-RD04A_ERR	BIT	Uxy.00.0	Temperature input module : Module error
Input	XBF-RD04A_RDY	BIT	Uxy.00.F	Temperature input module : Module ready
Input	XBF-RD04A_CH0_ACT	BIT	Uxy.01.0	Temperature input module : Channel 0 RUN
Input	XBF-RD04A_CH1_ACT	BIT	Uxy.01.1	Temperature input module : Channel 1 RUN
Input	XBF-RD04A_CH2_ACT	BIT	Uxy.01.2	Temperature input module : Channel 2 RUN
Input	XBF-RD04A_CH3_ACT	BIT	Uxy.01.3	Temperature input module : Channel 3 RUN
Input	XBF-RD04A_CH0_BOUT	BIT	Uxy.01.4	Temperature input module : Channel 0 disconnection
Input	XBF-RD04A_CH1_BOUT	BIT	Uxy.01.5	Temperature input module : Channel 1 disconnection
Input	XBF-RD04A_CH2_BOUT	BIT	Uxy.01.6	Temperature input module : Channel 2 disconnection
Input	XBF-RD04A_CH3_BOUT	BIT	Uxy.01.7	Temperature input module : Channel 3 disconnection
Input	XBF-RD04A_CH0_TEMP	Word	Uxy.04	Temperature input module : Channel 0 temperature data
Input	XBF-RD04A_CH1_TEMP	Word	Uxy.05	Temperature input module : Channel 1 temperature data
Input	XBF-RD04A_CH2_TEMP	Word	Uxy.06	Temperature input module : Channel 2 temperature data
Input	XBF-RD04A_CH3_TEMP	Word	Uxy.07	Temperature input module : Channel 3 temperature data
Input	XBF-RD04A_CH0_SCAL	Word	Uxy.08	Temperature input module : Channel 0 scaling data
Input	XBF-RD04A_CH1_SCAL	Word	Uxy.09	Temperature input module : Channel 1 scaling data
Input	XBF-RD04A_CH2_SCAL	Word	Uxy.10	Temperature input module : Channel 2 scaling data
Input	XBF-RD04A_CH3_SCAL	Word	Uxy.11	Temperature input module : Channel 3 scaling data

2) Refresh data

<Input>

Input/Output	Variable	Type	Word(16BIT) Offset	Comment
Input	XBF-RD04A_ERR	BIT	0.0	Temperature input module : Module error
Input	XBF-RD04A_RDY	BIT	0.F	Temperature input module : Module ready
Input	XBF-RD04A_CH0_ACT	BIT	1.0	Temperature input module : Channel 0 RUN
Input	XBF-RD04A_CH1_ACT	BIT	1.1	Temperature input module : Channel 1 RUN
Input	XBF-RD04A_CH2_ACT	BIT	1.2	Temperature input module : Channel 2 RUN
Input	XBF-RD04A_CH3_ACT	BIT	1.3	Temperature input module : Channel 3 RUN
Input	XBF-RD04A_CH0_BOUT	BIT	1.4	Temperature input module : Channel 0 disconnection
Input	XBF-RD04A_CH1_BOUT	BIT	1.5	Temperature input module : Channel 1 disconnection
Input	XBF-RD04A_CH2_BOUT	BIT	1.6	Temperature input module : Channel 2 disconnection
Input	XBF-RD04A_CH3_BOUT	BIT	1.7	Temperature input module : Channel 3 disconnection
Input		WORD	2	Reserved
Input		WORD	3	Reserved
Input	XBF-RD04A_CH0_TEMP	Word	4	Temperature input module : Channel 0 temperature data
Input	XBF-RD04A_CH1_TEMP	Word	5	Temperature input module : Channel 1 temperature data
Input	XBF-RD04A_CH2_TEMP	Word	6	Temperature input module : Channel 2 temperature data
Input	XBF-RD04A_CH3_TEMP	Word	7	Temperature input module : Channel 3 temperature data
Input	XBF-RD04A_CH0_SCAL	Word	8	Temperature input module : Channel 0 scaling data
Input	XBF-RD04A_CH1_SCAL	Word	9	Temperature input module : Channel 1 scaling data
Input	XBF-RD04A_CH2_SCAL	Word	10	Temperature input module : Channel 2 scaling data
Input	XBF-RD04A_CH3_SCAL	Word	11	Temperature input module : Channel 3 scaling data

(14) XBF-TC04S

1) U Device

Input/Output	Variable	Type	Device	Comment
Input	XBF-TC04S_CH0_ADJERR	BIT	Uxy.00 .0	Temperature input module : Channel 0 offset/gain error flag
Input	XBF-TC04S_CH1_ADJERR	BIT	Uxy.00 .1	Temperature input module : Channel 1 offset/gain error flag
Input	XBF-TC04S_CH2_ADJERR	BIT	Uxy.00 .2	Temperature input module : Channel 2 offset/gain error flag
Input	XBF-TC04S_CH3_ADJERR	BIT	Uxy.00 .3	Temperature input module : Channel 3 offset/gain error flag
Input	XBF-TC04S_EXT_PWR_ERR	BIT	Uxy.00 .C	Temperature input module : External power error
Input	XBF-TC04S_EEPROMERR	BIT	Uxy.00 .D	Temperature input module : Offset/gain backup error flag
Input	XBF-TC04S_WDT_ERR	BIT	Uxy.00 .E	Temperature input module: H/W error Flag
Input	XBF-TC04S_RDY	BIT	Uxy.00 .F	Temperature input module : Module ready
Input	XBF-TC04S_CH0_ACT	BIT	Uxy.01	Temperature input module : Channel 0 RUN

Appendix

			.0		
Input	XBF-TC04S_CH1_ACT	BIT	Uxy.01 .1	Temperature	input module : Channel 1 RUN
Input	XBF-TC04S_CH2_ACT	BIT	Uxy.01 .2	Temperature	input module : Channel 2 RUN
Input	XBF-TC04S_CH3_ACT	BIT	Uxy.01 .3	Temperature	input module : Channel 3 RUN
Input	XBF-TC04S_CH0_BOUT	BIT	Uxy.01 .4	Temperature	input module : Channel 0 disconnection
Input	XBF-TC04S_CH1_BOUT	BIT	Uxy.01 .5	Temperature	input module : Channel 1 disconnection
Input	XBF-TC04S_CH2_BOUT	BIT	Uxy.01 .6	Temperature	input module : Channel 2 disconnection
Input	XBF-TC04S_CH3_BOUT	BIT	Uxy.01 .7	Temperature	input module : Channel 3 disconnection
Input	XBF-TC04S_CH0_SETERR	BIT	Uxy.01 .8	Temperature	input module : Channel 0 error code
Input	XBF-TC04S_CH1_SETERR	BIT	Uxy.01 .9	Temperature	input module : Channel 1 error code
Input	XBF-TC04S_CH2_SETERR	BIT	Uxy.01 .A	Temperature	input module : Channel 2 error code
Input	XBF-TC04S_CH3_SETERR	BIT	Uxy.01 .B	Temperature	input module : Channel 3 error code
Output	XBF-TC04S_CH0_FINDEN	BIT	Uxy.29 .0	Temperature	input module : Channel 0 Max./Min. search enable/disable
Output	XBF-TC04S_CH1_FINDEN	BIT	Uxy.29 .1	Temperature	input module : Channel 1 Max./Min. search enable/disable
Output	XBF-TC04S_CH2_FINDEN	BIT	Uxy.29 .2	Temperature	input module : Channel 2 Max./Min. search enable/disable
Output	XBF-TC04S_CH3_FINDEN	BIT	Uxy.29 .3	Temperature	input module : Channel 3 Max./Min. search enable/disable
Output	XBF-TC04S_CH0_RJCDS	BIT	Uxy.29 .8	Temperature enable/disable	input module : Channel 0 cold junction compensation enable/disable
Output	XBF-TC04S_CH1_RJCDS	BIT	Uxy.29 .9	Temperature enable/disable	input module : Channel 1 cold junction compensation enable/disable
Output	XBF-TC04S_CH2_RJCDS	BIT	Uxy.29 .A	Temperature enable/disable	input module : Channel 2 cold junction compensation enable/disable
Output	XBF-TC04S_CH3_RJCDS	BIT	Uxy.29 .B	Temperature enable/disable	input module : Channel 3 cold junction compensation enable/disable
Input	XBF-TC04S_CH0_TEMP	Word	Uxy.04	Temperature	input module : Channel 0 temperature data
Input	XBF-TC04S_CH1_TEMP	Word	Uxy.05	Temperature	input module : Channel 1 temperature data
Input	XBF-TC04S_CH2_TEMP	Word	Uxy.06	Temperature	input module : Channel 2 temperature data
Input	XBF-TC04S_CH3_TEMP	Word	Uxy.07	Temperature	input module : Channel 3 temperature data
Input	XBF-TC04S_CH0_SCAL	Word	Uxy.08	Temperature	input module : Channel 0 scaling data
Input	XBF-TC04S_CH1_SCAL	Word	Uxy.09	Temperature	input module : Channel 1 scaling data
Input	XBF-TC04S_CH2_SCAL	Word	Uxy.10	Temperature	input module : Channel 2 scaling data
Input	XBF-TC04S_CH3_SCAL	Word	Uxy.11	Temperature	input module : Channel 3 scaling data
Input	XBF-TC04S_CH0_MIN	Word	Uxy.12	Temperature	input module : Channel 0 Min. data
Input	XBF-TC04S_CH0_MAX	Word	Uxy.13	Temperature	input module : Channel 0 Max. data

Input	XBF-TC04S_CH1_MIN	Word	Uxy.14	Temperature	input module : Channel 1 Min. data
Input	XBF-TC04S_CH1_MAX	Word	Uxy.15	Temperature	input module : Channel 1 Max. data
Input	XBF-TC04S_CH2_MIN	Word	Uxy.16	Temperature	input module : Channel 2 Min. data
Input	XBF-TC04S_CH2_MAX	Word	Uxy.17	Temperature	input module : Channel 2 Max. data
Input	XBF-TC04S_CH3_MIN	Word	Uxy.18	Temperature	input module : Channel 3 Min. data
Input	XBF-TC04S_CH3_MAX	Word	Uxy.19	Temperature	input module : Channel 3 Max. data

2) Refresh data

<Input>

Input/Output	Variable	Type	Word(16BIT) Offset	Comment
Input	XBF-TC04S_CH0_ADJERR	BIT	0.0	Temperature input module : Channel 0 offset/gain error flag
Input	XBF-TC04S_CH1_ADJERR	BIT	0.1	Temperature input module : Channel 1 offset/gain error flag
Input	XBF-TC04S_CH2_ADJERR	BIT	0.2	Temperature input module : Channel 2 offset/gain error flag
Input	XBF-TC04S_CH3_ADJERR	BIT	0.3	Temperature input module : Channel 3 offset/gain error flag
Input	XBF-TC04S_EXT_PWR_ERR	BIT	0.C	Temperature input module : External power error
Input	XBF-TC04S_EEPROMERR	BIT	0.D	Temperature input module : Offset/gain backup error flag
Input	XBF-TC04S_WDT_ERR	BIT	0.E	Temperature input module: H/W error Flag
Input	XBF-TC04S_RDY	BIT	0.F	Temperature input module : Module ready
Input	XBF-TC04S_CH0_ACT	BIT	1.0	Temperature input module : Channel 0 RUN
Input	XBF-TC04S_CH1_ACT	BIT	1.1	Temperature input module : Channel 1 RUN
Input	XBF-TC04S_CH2_ACT	BIT	1.2	Temperature input module : Channel 2 RUN
Input	XBF-TC04S_CH3_ACT	BIT	1.3	Temperature input module : Channel 3 RUN
Input	XBF-TC04S_CH0_BOUT	BIT	1.4	Temperature input module : Channel 0 disconnection
Input	XBF-TC04S_CH1_BOUT	BIT	1.5	Temperature input module : Channel 1 disconnection
Input	XBF-TC04S_CH2_BOUT	BIT	1.6	Temperature input module : Channel 2 disconnection
Input	XBF-TC04S_CH3_BOUT	BIT	1.7	Temperature input module : Channel 3 disconnection
Input	XBF-TC04S_CH0_SETERR	BIT	1.8	Temperature input module : Channel 0 error code
Input	XBF-TC04S_CH1_SETERR	BIT	1.9	Temperature input module : Channel 1 error code
Input	XBF-TC04S_CH2_SETERR	BIT	1.A	Temperature input module : Channel 2 error code
Input	XBF-TC04S_CH3_SETERR	BIT	1.B	Temperature input module : Channel 3 error code
Input	-	WORD	2	Reserved
Input	-	WORD	3	Reserved
Input	XBF-TC04S_CH0_TEMP	Word	4	Temperature input module : Channel 0 temperature data
Input	XBF-TC04S_CH1_TEMP	Word	5	Temperature input module : Channel 1 temperature data
Input	XBF-TC04S_CH2_TEMP	Word	6	Temperature input module : Channel 2 temperature data
Input	XBF-TC04S_CH3_TEMP	Word	7	Temperature input module : Channel 3 temperature data
Input	XBF-TC04S_CH0_SCAL	Word	8	Temperature input module : Channel 0 scaling data
Input	XBF-TC04S_CH1_SCAL	Word	9	Temperature input module : Channel 1 scaling data
Input	XBF-TC04S_CH2_SCAL	Word	10	Temperature input module : Channel 2 scaling data
Input	XBF-TC04S_CH3_SCAL	Word	11	Temperature input module : Channel 3 scaling data
Input	XBF-TC04S_CH0_MIN	Word	12	Temperature input module : Channel 0 Min. data

Appendix

Input	XBF-TC04S_CH0_MAX	Word	13	Temperature input module : Channel 0 Max. data
Input	XBF-TC04S_CH1_MIN	Word	14	Temperature input module : Channel 1 Min. data
Input	XBF-TC04S_CH1_MAX	Word	15	Temperature input module : Channel 1 Max. data
Input	XBF-TC04S_CH2_MIN	Word	16	Temperature input module : Channel 2 Min. data
Input	XBF-TC04S_CH2_MAX	Word	17	Temperature input module : Channel 2 Max. data
Input	XBF-TC04S_CH3_MIN	Word	18	Temperature input module : Channel 3 Min. data
Input	XBF-TC04S_CH3_MAX	Word	19	Temperature input module : Channel 3 Max. data

<Output>

Input/Output	Variable	Type	Word(16BIT) Offset	Comment
Output	XBF-TC04S_CH0_FINDEN	BIT	0.0	Temperature input module : Channel 0 Max./Min. search enable/disable
Output	XBF-TC04S_CH1_FINDEN	BIT	0.1	Temperature input module : Channel 1 Max./Min. search enable/disable
Output	XBF-TC04S_CH2_FINDEN	BIT	0.2	Temperature input module : Channel 2 Max./Min. search enable/disable
Output	XBF-TC04S_CH3_FINDEN	BIT	0.3	Temperature input module : Channel 3 Max./Min. search enable/disable
Output	XBF-TC04S_CH0_RJCDS	BIT	0.8	Temperature input module : Channel 0 cold junction compensation enable/disable
Output	XBF-TC04S_CH1_RJCDS	BIT	0.9	Temperature input module : Channel 1 cold junction compensation enable/disable
Output	XBF-TC04S_CH2_RJCDS	BIT	0.A	Temperature input module : Channel 2 cold junction compensation enable/disable
Output	XBF-TC04S_CH3_RJCDS	BIT	0.B	Temperature input module : Channel 3 cold junction compensation enable/disable

(15) XBF-TC04B

1) U Device

Input/Output	Variable	Type	Device	Comment
Input	XBF-TC04B_CH0_ADJERR	BIT	Uxy.00.0	Temperature input module : Channel 0 offset/gain error flag
Input	XBF-TC04B_CH1_ADJERR	BIT	Uxy.00.1	Temperature input module : Channel 1 offset/gain error flag
Input	XBF-TC04B_CH2_ADJERR	BIT	Uxy.00.2	Temperature input module : Channel 2 offset/gain error flag
Input	XBF-TC04B_CH3_ADJERR	BIT	Uxy.00.3	Temperature input module : Channel 3 offset/gain error flag
Input	XBF-TC04B_EXT_PWR_ERR	BIT	Uxy.00.C	Temperature input module : External power error
Input	XBF-TC04B_EEPROMERR	BIT	Uxy.00.D	Temperature input module : Offset/gain backup error flag
Input	XBF-TC04B_WDT_ERR	BIT	Uxy.00.E	Temperature input module: H/W error Flag
Input	XBF-TC04B_RDY	BIT	Uxy.00.F	Temperature input module : Module ready
Input	XBF-TC04B_CH0_ACT	BIT	Uxy.01.0	Temperature input module : Channel 0 RUN
Input	XBF-TC04B_CH1_ACT	BIT	Uxy.01.1	Temperature input module : Channel 1 RUN
Input	XBF-TC04B_CH2_ACT	BIT	Uxy.01.2	Temperature input module : Channel 2 RUN

Input	XBF-TC04B_CH3_ACT	BIT	Uxy.01.3	Temperature input module : Channel 3 RUN
Input	XBF-TC04B_CH0_BOUT	BIT	Uxy.01.4	Temperature input module : Channel 0 disconnection
Input	XBF-TC04B_CH1_BOUT	BIT	Uxy.01.5	Temperature input module : Channel 1 disconnection
Input	XBF-TC04B_CH2_BOUT	BIT	Uxy.01.6	Temperature input module : Channel 2 disconnection
Input	XBF-TC04B_CH3_BOUT	BIT	Uxy.01.7	Temperature input module : Channel 3 disconnection
Input	XBF-TC04B_CH0_SETERR	BIT	Uxy.01.8	Temperature input module : Channel 0 error code
Input	XBF-TC04B_CH1_SETERR	BIT	Uxy.01.9	Temperature input module : Channel 1 error code
Input	XBF-TC04B_CH2_SETERR	BIT	Uxy.01.A	Temperature input module : Channel 2 error code
Input	XBF-TC04B_CH3_SETERR	BIT	Uxy.01.B	Temperature input module : Channel 3 error code
Output	XBF-TC04B_CH0_FINDEN	BIT	Uxy.29.0	Temperature input module : Channel 0 Max./Min. search enable/disable
Output	XBF-TC04B_CH1_FINDEN	BIT	Uxy.29.1	Temperature input module : Channel 1 Max./Min. search enable/disable
Output	XBF-TC04B_CH2_FINDEN	BIT	Uxy.29.2	Temperature input module : Channel 2 Max./Min. search enable/disable
Output	XBF-TC04B_CH3_FINDEN	BIT	Uxy.29.3	Temperature input module : Channel 3 Max./Min. search enable/disable
Output	XBF-TC04B_CH0_RJCDS	BIT	Uxy.29.8	Temperature input module : Channel 0 cold junction compensation enable/disable
Output	XBF-TC04B_CH1_RJCDS	BIT	Uxy.29.9	Temperature input module : Channel 1 cold junction compensation enable/disable
Output	XBF-TC04B_CH2_RJCDS	BIT	Uxy.29.A	Temperature input module : Channel 2 cold junction compensation enable/disable
Output	XBF-TC04B_CH3_RJCDS	BIT	Uxy.29.B	Temperature input module : Channel 3 cold junction compensation enable/disable
Input	XBF-TC04B_CH0_TEMP	Word	Uxy.04	Temperature input module : Channel 0 temperature data
Input	XBF-TC04B_CH1_TEMP	Word	Uxy.05	Temperature input module : Channel 1 temperature data
Input	XBF-TC04B_CH2_TEMP	Word	Uxy.06	Temperature input module : Channel 2 temperature data
Input	XBF-TC04B_CH3_TEMP	Word	Uxy.07	Temperature input module : Channel 3 temperature data
Input	XBF-TC04B_CH0_SCAL	Word	Uxy.08	Temperature input module : Channel 0 scaling data
Input	XBF-TC04B_CH1_SCAL	Word	Uxy.09	Temperature input module : Channel 1 scaling data
Input	XBF-TC04B_CH2_SCAL	Word	Uxy.10	Temperature input module : Channel 2 scaling data
Input	XBF-TC04B_CH3_SCAL	Word	Uxy.11	Temperature input module : Channel 3 scaling data
Input	XBF-TC04B_CH0_MIN	Word	Uxy.12	Temperature input module : Channel 0 Min. data
Input	XBF-TC04B_CH0_MAX	Word	Uxy.13	Temperature input module : Channel 0 Max. data
Input	XBF-TC04B_CH1_MIN	Word	Uxy.14	Temperature input module : Channel 1 Min. data
Input	XBF-TC04B_CH1_MAX	Word	Uxy.15	Temperature input module : Channel 1 Max. data
Input	XBF-TC04B_CH2_MIN	Word	Uxy.16	Temperature input module : Channel 2 Min. data
Input	XBF-TC04B_CH2_MAX	Word	Uxy.17	Temperature input module : Channel 2 Max. data
Input	XBF-TC04B_CH3_MIN	Word	Uxy.18	Temperature input module : Channel 3 Min. data
Input	XBF-TC04B_CH3_MAX	Word	Uxy.19	Temperature input module : Channel 3 Max. data

2) Refresh data

<Input>

Appendix

Input/Output	Variable	Type	Word(16BIT) Offset	Comment
Input	XBF-TC04B_CH0_ADJERR	BIT	0.0	Temperature input module : Channel 0 offset/gain error flag
Input	XBF-TC04B_CH1_ADJERR	BIT	0.1	Temperature input module : Channel 1 offset/gain error flag
Input	XBF-TC04B_CH2_ADJERR	BIT	0.2	Temperature input module : Channel 2 offset/gain error flag
Input	XBF-TC04B_CH3_ADJERR	BIT	0.3	Temperature input module : Channel 3 offset/gain error flag
Input	XBF-TC04B_EXT_PWR_ERR	BIT	0.C	Temperature input module : External power error
Input	XBF-TC04B_EEPROMERR	BIT	0.D	Temperature input module : Offset/gain backup error flag
Input	XBF-TC04B_WDT_ERR	BIT	0.E	Temperature input module: H/W error Flag
Input	XBF-TC04B_RDY	BIT	0.F	Temperature input module : Module ready
Input	XBF-TC04B_CH0_ACT	BIT	1.0	Temperature input module : Channel 0 RUN
Input	XBF-TC04B_CH1_ACT	BIT	1.1	Temperature input module : Channel 1 RUN
Input	XBF-TC04B_CH2_ACT	BIT	1.2	Temperature input module : Channel 2 RUN
Input	XBF-TC04B_CH3_ACT	BIT	1.3	Temperature input module : Channel 3 RUN
Input	XBF-TC04B_CH0_BOUT	BIT	1.4	Temperature input module : Channel 0 disconnection
Input	XBF-TC04B_CH1_BOUT	BIT	1.5	Temperature input module : Channel 1 disconnection
Input	XBF-TC04B_CH2_BOUT	BIT	1.6	Temperature input module : Channel 2 disconnection
Input	XBF-TC04B_CH3_BOUT	BIT	1.7	Temperature input module : Channel 3 disconnection
Input	XBF-TC04B_CH0_SETERR	BIT	1.8	Temperature input module : Channel 0 error code
Input	XBF-TC04B_CH1_SETERR	BIT	1.9	Temperature input module : Channel 1 error code
Input	XBF-TC04B_CH2_SETERR	BIT	1.A	Temperature input module : Channel 2 error code
Input	XBF-TC04B_CH3_SETERR	BIT	1.B	Temperature input module : Channel 3 error code
Input		WORD	2	Reserved
Input		WORD	3	Reserved
Input	XBF-TC04B_CH0_TEMP	Word	4	Temperature input module : Channel 0 temperature data
Input	XBF-TC04B_CH1_TEMP	Word	5	Temperature input module : Channel 1 temperature data
Input	XBF-TC04B_CH2_TEMP	Word	6	Temperature input module : Channel 2 temperature data
Input	XBF-TC04B_CH3_TEMP	Word	7	Temperature input module : Channel 3 temperature data
Input	XBF-TC04B_CH0_SCAL	Word	8	Temperature input module : Channel 0 scaling data
Input	XBF-TC04B_CH1_SCAL	Word	9	Temperature input module : Channel 1 scaling data
Input	XBF-TC04B_CH2_SCAL	Word	10	Temperature input module : Channel 2 scaling data
Input	XBF-TC04B_CH3_SCAL	Word	11	Temperature input module : Channel 3 scaling data
Input	XBF-TC04B_CH0_MIN	Word	12	Temperature input module : Channel 0 Min. data
Input	XBF-TC04B_CH0_MAX	Word	13	Temperature input module : Channel 0 Max. data
Input	XBF-TC04B_CH1_MIN	Word	14	Temperature input module : Channel 1 Min. data
Input	XBF-TC04B_CH1_MAX	Word	15	Temperature input module : Channel 1 Max. data
Input	XBF-TC04B_CH2_MIN	Word	16	Temperature input module : Channel 2 Min. data
Input	XBF-TC04B_CH2_MAX	Word	17	Temperature input module : Channel 2 Max. data
Input	XBF-TC04B_CH3_MIN	Word	18	Temperature input module : Channel 3 Min. data
Input	XBF-TC04B_CH3_MAX	Word	19	Temperature input module : Channel 3 Max. data

<Output>

Input/Output	Variable	Type	Word(16BIT) Offset	Comment
Output	XBF-TC04B_CH0_FINDEN	BIT	0.0	Temperature input module : Channel 0 Max./Min. search enable/disable
Output	XBF-TC04B_CH1_FINDEN	BIT	0.1	Temperature input module : Channel 1 Max./Min. search enable/disable
Output	XBF-TC04B_CH2_FINDEN	BIT	0.2	Temperature input module : Channel 2 Max./Min. search enable/disable

Output	XBF-TC04B_CH3_FINDEN	BIT	0.3	Temperature input module : Channel 3 Max./Min. search enable/disable
Output	XBF-TC04B_CH0_RJCDS	BIT	0.8	Temperature input module : Channel 0 cold junction compensation enable/disable
Output	XBF-TC04B_CH1_RJCDS	BIT	0.9	Temperature input module : Channel 1 cold junction compensation enable/disable
Output	XBF-TC04B_CH2_RJCDS	BIT	0.A	Temperature input module : Channel 2 cold junction compensation enable/disable
Output	XBF-TC04B_CH3_RJCDS	BIT	0.B	Temperature input module : Channel 3 cold junction compensation enable/disable

(16) XBF-LD02S

1) U Device

Input/Output	Variable	Type	Device	Comment
Input	XBF-LD02S_ERR	BIT	Uxy.00.0	Loadcell input module Module error
Input	XBF-LD02S_RDY	BIT	Uxy.00.F	Loadcell input module Module ready
Input	XBF-LD02S_CH0_RUN	BIT	Uxy.01.0	Loadcell input module CH0 RUN
Input	XBF-LD02S_CH1_RUN	BIT	Uxy.01.1	Loadcell input module CH1 RUN
Input	XBF-LD02S_CH0_CALMOD	BIT	Uxy.01.8	Loadcell input module Channel 0 calibration status
Input	XBF-LD02S_CH1_CALMOD	BIT	Uxy.01.9	Loadcell input module Channel 1 calibration status
Input	XBF-LD02S_CH0_ERR	BIT	Uxy.01.E	Loadcell input module Channel 0 error
Input	XBF-LD02S_CH1_ERR	BIT	Uxy.01.F	Loadcell input module Channel 1 error
Input	XBF-LD02S_CH0_STBL	BIT	Uxy.02.0	Loadcell input module Channel 0 stable status
Input	XBF-LD02S_CH1_STBL	BIT	Uxy.02.1	Loadcell input module Channel 1 stable status
Input	XBF-LD02S_CH0_ZERO	BIT	Uxy.02.2	Loadcell input module Channel 0 zero status
Input	XBF-LD02S_CH1_ZERO	BIT	Uxy.02.3	Loadcell input module Channel 1 zero status
Input	XBF-LD02S_CH0_COMPLETE	BIT	Uxy.02.4	Loadcell input module Channel 0 weighing complete status
Input	XBF-LD02S_CH1_COMPLETE	BIT	Uxy.02.5	Loadcell input module Channel 1 weighing complete status
Input	XBF-LD02S_CH0_SP1	BIT	Uxy.02.6	Loadcell input module Channel 0 step1 status
Input	XBF-LD02S_CH0_SP2	BIT	Uxy.02.7	Loadcell input module Channel 0 step2 status
Input	XBF-LD02S_CH0_SP3	BIT	Uxy.02.8	Loadcell input module Channel 0 step3 status
Input	XBF-LD02S_CH0_UNDER	BIT	Uxy.02.9	Loadcell input module Channel 0 lack status
Input	XBF-LD02S_CH0_OVER	BIT	Uxy.02.A	Loadcell input module Channel 0 over status
Input	XBF-LD02S_CH1_SP1	BIT	Uxy.02.B	Loadcell input module Channel 1 step1 status
Input	XBF-LD02S_CH1_SP2	BIT	Uxy.02.C	Loadcell input module Channel 1 step2 status
Input	XBF-LD02S_CH1_SP3	BIT	Uxy.02.D	Loadcell input module Channel 1 step3 status
Input	XBF-LD02S_CH1_UNDER	BIT	Uxy.02.E	Loadcell input module Channel 1 lack status
Input	XBF-LD02S_CH1_OVER	BIT	Uxy.02.F	Loadcell input module Channel 1 over status
Input	XBF-LD02S_CH0_ZCALEND	BIT	Uxy.03.0	Loadcell input module Channel 0 zero calibration status
Input	XBF-LD02S_CH1_ZCALEND	BIT	Uxy.03.1	Loadcell input module Channel 1 zero calibration status
Input	XBF-LD02S_CH0_SCALEND	BIT	Uxy.03.2	Loadcell input module Channel 0 span calibration status
Input	XBF-LD02S_CH1_SCALEND	BIT	Uxy.03.3	Loadcell input module Channel 1 span calibration status
Input	XBF-LD02S_CH0_CALEND	BIT	Uxy.03.4	Loadcell input module Channel 0 save complete flag
Input	XBF-LD02S_CH1_CALEND	BIT	Uxy.03.5	Loadcell input module Channel 1 save complete flag
Input	XBF-LD02S_CH0_EQUCALEND	BIT	Uxy.03.6	Loadcell input module Channel 0 equivalent calibration status
Input	XBF-LD02S_CH1_EQUCALEND	BIT	Uxy.03.7	Loadcell input module Channel 1 equivalent calibration status
Input	XBF-LD02S_CH0_ZSET	BIT	Uxy.04.0	Loadcell input module Channel 0 zero setting status

Appendix

Input	XBF-LD02S_CH1_ZSET	BIT	Uxy.04.1	Loadcell input module Channel 1 zero setting status
Input	XBF-LD02S_CH0_ZRST	BIT	Uxy.04.2	Loadcell input module Channel 0 zero reset status
Input	XBF-LD02S_CH1_ZRST	BIT	Uxy.04.3	Loadcell input module Channel 1 zero reset status
Input	XBF-LD02S_CH0_TSET	BIT	Uxy.04.4	Loadcell input module Channel 0 tare setting status
Input	XBF-LD02S_CH1_TSET	BIT	Uxy.04.5	Loadcell input module Channel 1 tare setting status
Input	XBF-LD02S_CH0_WEIGHTHLD	BIT	Uxy.04.6	Loadcell input module Channel 0 output hold status
Input	XBF-LD02S_CH1_WEIGHTHLD	BIT	Uxy.04.7	Loadcell input module Channel 1 output hold status
Input	XBF-LD02S_CH0_MINMAXHLD	BIT	Uxy.04.8	Loadcell input module Channel 0 Min./Max. hold status
Input	XBF-LD02S_CH1_MINMAXHLD	BIT	Uxy.04.9	Loadcell input module Channel 1 Min./Max. hold status
Input	XBF-LD02S_CH0_NEARZERO	BIT	Uxy.04.A	Loadcell input module Channel 0 near zero status
Input	XBF-LD02S_CH1_NEARZERO	BIT	Uxy.04.B	Loadcell input module Channel 1 near zero status
Input	XBF-LD02S_CH0_GRSMINUS	BIT	Uxy.04.C	Loadcell input module Channel 0 gross weight negative status
Input	XBF-LD02S_CH1_GRSMINUS	BIT	Uxy.04.D	Loadcell input module Channel 1 gross weight negative status
Input	XBF-LD02S_CH0_NETMINUS	BIT	Uxy.04.E	Loadcell input module Channel 0 net weight negative status
Input	XBF-LD02S_CH1_NETMINUS	BIT	Uxy.04.F	Loadcell input module Channel 1 net weight negative status
Input	XBF-LD02S_CH0_HOOR	BIT	Uxy.05.0	Loadcell input module Channel 0 upper alarm
Input	XBF-LD02S_CH1_HOOR	BIT	Uxy.05.1	Loadcell input module Channel 1 upper alarm
Input	XBF-LD02S_CH0_LOOR	BIT	Uxy.05.2	Loadcell input module Channel 0 lower alarm
Input	XBF-LD02S_CH1_LOOR	BIT	Uxy.05.3	Loadcell input module Channel 1 lower alarm
Input	XBF-LD02S_CH0_HHOORSTAT	BIT	Uxy.05.8	Loadcell input module Channel 0 high high status
Input	XBF-LD02S_CH0_HOORSTAT	BIT	Uxy.05.9	Loadcell input module Channel 0 high status
Input	XBF-LD02S_CH0_LOORSTAT	BIT	Uxy.05.A	Loadcell input module Channel 0 low status
Input	XBF-LD02S_CH0_LLOORSTAT	BIT	Uxy.05.B	Loadcell input module Channel 0 low low status
Input	XBF-LD02S_CH1_HHOORSTAT	BIT	Uxy.05.C	Loadcell input module Channel 1 high high status
Input	XBF-LD02S_CH1_HOORSTAT	BIT	Uxy.05.D	Loadcell input module Channel 1 high status
Input	XBF-LD02S_CH1_LOORSTAT	BIT	Uxy.05.E	Loadcell input module Channel 1 low status
Input	XBF-LD02S_CH1_LLOORSTAT	BIT	Uxy.05.F	Loadcell input module Channel 1 low low status
Output	XBF-LD02S_CH0_CAL1REQ	BIT	Uxy.29.0	Loadcell input module Channel 0 1 point calibration request
Output	XBF-LD02S_CH1_CAL1REQ	BIT	Uxy.29.1	Loadcell input module Channel 1 1 point calibration request
Output	XBF-LD02S_CH0_CAL2REQ	BIT	Uxy.29.2	Loadcell input module Channel 0 2 point calibration request
Output	XBF-LD02S_CH1_CAL2REQ	BIT	Uxy.29.3	Loadcell input module Channel 1 2 point calibration request
Output	XBF-LD02S_CH0_EQUCALREQ	BIT	Uxy.29.4	Loadcell input module Channel 0 equivalent calibration request
Output	XBF-LD02S_CH1_EQUCALREQ	BIT	Uxy.29.5	Loadcell input module Channel 1 equivalent calibration request
Output	XBF-LD02S_CH0_ZCALREQ	BIT	Uxy.30.0	Loadcell input module Channel 0 zero calibration request
Output	XBF-LD02S_CH1_ZCALREQ	BIT	Uxy.30.1	Loadcell input module Channel 1 zero calibration request
Output	XBF-LD02S_CH0_SCALREQ	BIT	Uxy.30.2	Loadcell input module Channel 0 span calibration request
Output	XBF-LD02S_CH1_SCALREQ	BIT	Uxy.30.3	Loadcell input module Channel 1 span calibration request
Output	XBF-LD02S_CH0_CALSTORE	BIT	Uxy.30.4	Loadcell input module Channel 0 save request
Output	XBF-LD02S_CH1_CALSTORE	BIT	Uxy.30.5	Loadcell input module Channel 1 save request
Output	XBF-LD02S_CH0_ZSETREQ	BIT	Uxy.31.0	Loadcell input module Channel 0 zero setting request
Output	XBF-LD02S_CH1_ZSETREQ	BIT	Uxy.31.1	Loadcell input module Channel 1 zero setting request
Output	XBF-LD02S_CH0_ZRSTREQ	BIT	Uxy.31.2	Loadcell input module Channel 0 zero reset request
Output	XBF-LD02S_CH1_ZRSTREQ	BIT	Uxy.31.3	Loadcell input module Channel 1 zero reset request
Output	XBF-LD02S_CH0_TAREREQ	BIT	Uxy.31.4	Loadcell input module Channel 0 tare setting
Output	XBF-LD02S_CH1_TAREREQ	BIT	Uxy.31.5	Loadcell input module Channel 1 tare setting
Output	XBF-LD02S_CH0_HOLDREQ	BIT	Uxy.31.6	Loadcell input module Channel 0 output hold request
Output	XBF-LD02S_CH1_HOLDREQ	BIT	Uxy.31.7	Loadcell input module Channel 1 output hold request
Output	XBF-LD02S_CH0_MAXMINREQ	BIT	Uxy.31.8	Loadcell input module Channel 0 Min./Max. hold request
Output	XBF-LD02S_CH1_MAXMINREQ	BIT	Uxy.31.9	Loadcell input module Channel 1 Min./Max. hold request

Output	XBF-LD02S_CH0_SEQREQ	BIT	Uxy.31.A	Loadcell input module Channel 0 sequential control request
Output	XBF-LD02S_CH1_SEQREQ	BIT	Uxy.31.B	Loadcell input module Channel 1 sequential control request
Output	XBF-LD02S_CH0_TARERSTREQ	BIT	Uxy.31.C	Loadcell input module Channel 0 tare release request
Output	XBF-LD02S_CH1_TARERSTREQ	BIT	Uxy.31.D	Loadcell input module Channel 1 tare release request
Input	XBF-LD02S_CH0_GWDATA_L	Word	Uxy.06	Loadcell input module Channel 0 gross weight data(Lower)
Input	XBF-LD02S_CH0_GWDATA_H	Word	Uxy.07	Loadcell input module Channel 0 gross weight data(Upper)
Input	XBF-LD02S_CH1_GWDATA_L	Word	Uxy.08	Loadcell input module Channel 1 gross weight data(Lower)
Input	XBF-LD02S_CH1_GWDATA_H	Word	Uxy.09	Loadcell input module Channel 1 gross weight data(Upper)
Input	XBF-LD02S_CH0_TAREDATA_L	Word	Uxy.10	Loadcell input module Channel 0 tare weight data(Lower)
Input	XBF-LD02S_CH0_TAREDATA_H	Word	Uxy.11	Loadcell input module Channel 0 tare weight data(Upper)
Input	XBF-LD02S_CH1_TAREDATA_L	Word	Uxy.12	Loadcell input module Channel 1 tare weight data(Lower)
Input	XBF-LD02S_CH1_TAREDATA_H	Word	Uxy.13	Loadcell input module Channel 1 tare weight data(Upper)
Input	XBF-LD02S_CH0_NETDATA_L	Word	Uxy.14	Loadcell input module Channel 0 net weight data(Lower)
Input	XBF-LD02S_CH0_NETDATA_H	Word	Uxy.15	Loadcell input module Channel 0 net weight data(Upper)
Input	XBF-LD02S_CH1_NETDATA_L	Word	Uxy.16	Loadcell input module Channel 1 net weight data(Lower)
Input	XBF-LD02S_CH1_NETDATA_H	Word	Uxy.17	Loadcell input module Channel 1 net weight data(Upper)
Input	XBF-LD02S_CH0_GWMAX_L	Word	Uxy.18	Loadcell input module Channel 0 gross weight max. data(Lower)
Input	XBF-LD02S_CH0_GWMAX_H	Word	Uxy.19	Loadcell input module Channel 0 gross weight max. data(Upper)
Input	XBF-LD02S_CH0_GWMIN_L	Word	Uxy.20	Loadcell input module Channel 0 gross weight Min. data(Lower)
Input	XBF-LD02S_CH0_GWMIN_H	Word	Uxy.21	Loadcell input module Channel 0 gross weight Min. data(Upper)
Input	XBF-LD02S_CH1_GWMAX_L	Word	Uxy.22	Loadcell input module Channel 1 gross weight max. data(Lower)
Input	XBF-LD02S_CH1_GWMAX_H	Word	Uxy.23	Loadcell input module Channel 1 gross weight max. data(Upper)
Input	XBF-LD02S_CH1_GWMIN_L	Word	Uxy.24	Loadcell input module Channel 1 gross weight Min. data(Lower)
Input	XBF-LD02S_CH1_GWMIN_H	Word	Uxy.25	Loadcell input module Channel 1 gross weight Min. data(Upper)
Input	XBF-LD02S_CH0_CUR_FFVAL	Word	Uxy.26	Loadcell input module Channel 0 free fall data
Input	XBF-LD02S_CH1_CUR_FFVAL	Word	Uxy.27	Loadcell input module Channel 1 free fall data
Input	XBF-LD02S_ECODE	Word	Uxy.28	Loadcell input module Error code

2) Refresh data

<Input>

Input/Output	Variable	Type	Word(16BIT) Offset	Comment
Input	XBF-LD02S_ERR	BIT	0.0	Loadcell input module Module error
Input	XBF-LD02S_RDY	BIT	0.F	Loadcell input module Module ready
Input	XBF-LD02S_CH0_RUN	BIT	1.0	Loadcell input module CH0 RUN
Input	XBF-LD02S_CH1_RUN	BIT	1.1	Loadcell input module CH1 RUN
Input	XBF-LD02S_CH0_CALMOD	BIT	1.8	Loadcell input module Channel 0 calibration status
Input	XBF-LD02S_CH1_CALMOD	BIT	1.9	Loadcell input module Channel 1 calibration status
Input	XBF-LD02S_CH0_ERR	BIT	1.E	Loadcell input module Channel 0 error
Input	XBF-LD02S_CH1_ERR	BIT	1.F	Loadcell input module Channel 1 error
Input	XBF-LD02S_CH0_STBL	BIT	2.0	Loadcell input module Channel 0 stable status
Input	XBF-LD02S_CH1_STBL	BIT	2.1	Loadcell input module Channel 1 stable status
Input	XBF-LD02S_CH0_ZERO	BIT	2.2	Loadcell input module Channel 0 zero status
Input	XBF-LD02S_CH1_ZERO	BIT	2.3	Loadcell input module Channel 1 zero status
Input	XBF-LD02S_CH0_COMPLETE	BIT	2.4	Loadcell input module Channel 0 weighing complete status
Input	XBF-LD02S_CH1_COMPLETE	BIT	2.5	Loadcell input module Channel 1 weighing complete status
Input	XBF-LD02S_CH0_SP1	BIT	2.6	Loadcell input module Channel 0 step1 status

Appendix

Input	XBF-LD02S_CH0_SP2	BIT	2.7	Loadcell input module Channel 0 step2 status
Input	XBF-LD02S_CH0_SP3	BIT	2.8	Loadcell input module Channel 0 step3 status
Input	XBF-LD02S_CH0_UNDER	BIT	2.9	Loadcell input module Channel 0 lack status
Input	XBF-LD02S_CH0_OVER	BIT	2.A	Loadcell input module Channel 0 over status
Input	XBF-LD02S_CH1_SP1	BIT	2.B	Loadcell input module Channel 1 step1 status
Input	XBF-LD02S_CH1_SP2	BIT	2.C	Loadcell input module Channel 1 step2 status
Input	XBF-LD02S_CH1_SP3	BIT	2.D	Loadcell input module Channel 1 step3 status
Input	XBF-LD02S_CH1_UNDER	BIT	2.E	Loadcell input module Channel 1 lack status
Input	XBF-LD02S_CH1_OVER	BIT	2.F	Loadcell input module Channel 1 over status
Input	XBF-LD02S_CH0_ZCALEND	BIT	3.0	Loadcell input module Channel 0 zero calibration status
Input	XBF-LD02S_CH1_ZCALEND	BIT	3.1	Loadcell input module Channel 1 zero calibration status
Input	XBF-LD02S_CH0_SCALEND	BIT	3.2	Loadcell input module Channel 0 span calibration status
Input	XBF-LD02S_CH1_SCALEND	BIT	3.3	Loadcell input module Channel 1 span calibration status
Input	XBF-LD02S_CH0_CALEND	BIT	3.4	Loadcell input module Channel 0 save complete flag
Input	XBF-LD02S_CH1_CALEND	BIT	3.5	Loadcell input module Channel 1 save complete flag
Input	XBF-LD02S_CH0_EQUCALEND	BIT	3.6	Loadcell input module Channel 0 equivalent calibration status
Input	XBF-LD02S_CH1_EQUCALEND	BIT	3.7	Loadcell input module Channel 1 equivalent calibration status
Input	XBF-LD02S_CH0_ZSET	BIT	4.0	Loadcell input module Channel 0 zero setting status
Input	XBF-LD02S_CH1_ZSET	BIT	4.1	Loadcell input module Channel 1 zero setting status
Input	XBF-LD02S_CH0_ZRST	BIT	4.2	Loadcell input module Channel 0 zero reset status
Input	XBF-LD02S_CH1_ZRST	BIT	4.3	Loadcell input module Channel 1 zero reset status
Input	XBF-LD02S_CH0_TSET	BIT	4.4	Loadcell input module Channel 0 tare setting status
Input	XBF-LD02S_CH1_TSET	BIT	4.5	Loadcell input module Channel 1 tare setting status
Input	XBF-LD02S_CH0_WEIGHTHLD	BIT	4.6	Loadcell input module Channel 0 output hold status
Input	XBF-LD02S_CH1_WEIGHTHLD	BIT	4.7	Loadcell input module Channel 1 output hold status
Input	XBF-LD02S_CH0_MINMAXHLD	BIT	4.8	Loadcell input module Channel 0 Min./Max. hold status
Input	XBF-LD02S_CH1_MINMAXHLD	BIT	4.9	Loadcell input module Channel 1 Min./Max. hold status
Input	XBF-LD02S_CH0_NEARZERO	BIT	4.A	Loadcell input module Channel 0 near zero status
Input	XBF-LD02S_CH1_NEARZERO	BIT	4.B	Loadcell input module Channel 1 near zero status
Input	XBF-LD02S_CH0_GRSMINUS	BIT	4.C	Loadcell input module Channel 0 gross weight negative status
Input	XBF-LD02S_CH1_GRSMINUS	BIT	4.D	Loadcell input module Channel 1 gross weight negative status
Input	XBF-LD02S_CH0_NETMINUS	BIT	4.E	Loadcell input module Channel 0 net weight negative status
Input	XBF-LD02S_CH1_NETMINUS	BIT	4.F	Loadcell input module Channel 1 net weight negative status
Input	XBF-LD02S_CH0_HOOR	BIT	5.0	Loadcell input module Channel 0 upper alarm
Input	XBF-LD02S_CH1_HOOR	BIT	5.1	Loadcell input module Channel 1 upper alarm
Input	XBF-LD02S_CH0_LOOR	BIT	5.2	Loadcell input module Channel 0 lower alarm
Input	XBF-LD02S_CH1_LOOR	BIT	5.3	Loadcell input module Channel 1 lower alarm
Input	XBF-LD02S_CH0_HHOORSTAT	BIT	5.8	Loadcell input module Channel 0 high high status
Input	XBF-LD02S_CH0_HOORSTAT	BIT	5.9	Loadcell input module Channel 0 high status
Input	XBF-LD02S_CH0_LOORSTAT	BIT	5.A	Loadcell input module Channel 0 low status
Input	XBF-LD02S_CH0_LLOORSTAT	BIT	5.B	Loadcell input module Channel 0 low low status
Input	XBF-LD02S_CH1_HHOORSTAT	BIT	5.C	Loadcell input module Channel 1 high high status
Input	XBF-LD02S_CH1_HOORSTAT	BIT	5.D	Loadcell input module Channel 1 high status
Input	XBF-LD02S_CH1_LOORSTAT	BIT	5.E	Loadcell input module Channel 1 low status
Input	XBF-LD02S_CH1_LLOORSTAT	BIT	5.F	Loadcell input module Channel 1 low low status

Input	XBF-LD02S_CH0_GWDATA_L	Word	6	Loadcell input module Channel 0 gross weight data(Lower)
Input	XBF-LD02S_CH0_GWDATA_H	Word	7	Loadcell input module Channel 0 gross weight data(Upper)
Input	XBF-LD02S_CH1_GWDATA_L	Word	8	Loadcell input module Channel 1 gross weight data(Lower)
Input	XBF-LD02S_CH1_GWDATA_H	Word	9	Loadcell input module Channel 1 gross weight data(Upper)
Input	XBF-LD02S_CH0_TAREDATA_L	Word	10	Loadcell input module Channel 0 tare weight data(Lower)
Input	XBF-LD02S_CH0_TAREDATA_H	Word	11	Loadcell input module Channel 0 tare weight data(Upper)
Input	XBF-LD02S_CH1_TAREDATA_L	Word	12	Loadcell input module Channel 1 tare weight data(Lower)
Input	XBF-LD02S_CH1_TAREDATA_H	Word	13	Loadcell input module Channel 1 tare weight data(Upper)
Input	XBF-LD02S_CH0_NETDATA_L	Word	14	Loadcell input module Channel 0 net weight data(Lower)
Input	XBF-LD02S_CH0_NETDATA_H	Word	15	Loadcell input module Channel 0 net weight data(Upper)
Input	XBF-LD02S_CH1_NETDATA_L	Word	16	Loadcell input module Channel 1 net weight data(Lower)
Input	XBF-LD02S_CH1_NETDATA_H	Word	17	Loadcell input module Channel 1 net weight data(Upper)
Input	XBF-LD02S_CH0_GWMAX_L	Word	18	Loadcell input module Channel 0 gross weight max. data(Lower)
Input	XBF-LD02S_CH0_GWMAX_H	Word	19	Loadcell input module Channel 0 gross weight max. data(Upper)
Input	XBF-LD02S_CH0_GWMIN_L	Word	20	Loadcell input module Channel 0 gross weight Min. data(Lower)
Input	XBF-LD02S_CH0_GWMIN_H	Word	21	Loadcell input module Channel 0 gross weight Min. data(Upper)
Input	XBF-LD02S_CH1_GWMAX_L	Word	22	Loadcell input module Channel 1 gross weight max. data(Lower)
Input	XBF-LD02S_CH1_GWMAX_H	Word	23	Loadcell input module Channel 1 gross weight max. data(Upper)
Input	XBF-LD02S_CH1_GWMIN_L	Word	24	Loadcell input module Channel 1 gross weight Min. data(Lower)
Input	XBF-LD02S_CH1_GWMIN_H	Word	25	Loadcell input module Channel 1 gross weight Min. data(Upper)
Input	XBF-LD02S_CH0_CUR_FFVAL	Word	26	Loadcell input module Channel 0 free fall data
Input	XBF-LD02S_CH1_CUR_FFVAL	Word	27	Loadcell input module Channel 1 free fall data
Input	XBF-LD02S_ECODE	Word	28	Loadcell input module Error code

<Output>

Input/Output	Variable	Type	Word(16BIT) Offset	Comment
--------------	----------	------	--------------------	---------

Appendix

Output	XBF-LD02S_CH0_CAL1REQ	BIT	0.0	Loadcell input module Channel 0 1 point calibration request
Output	XBF-LD02S_CH1_CAL1REQ	BIT	0.1	Loadcell input module Channel 1 1 point calibration request
Output	XBF-LD02S_CH0_CAL2REQ	BIT	0.2	Loadcell input module Channel 0 2 point calibration request
Output	XBF-LD02S_CH1_CAL2REQ	BIT	0.3	Loadcell input module Channel 1 2 point calibration request
Output	XBF-LD02S_CH0_EQUCALREQ	BIT	0.4	Loadcell input module Channel 0 equivalent calibration request
Output	XBF-LD02S_CH1_EQUCALREQ	BIT	0.5	Loadcell input module Channel 1 equivalent calibration request
Output	XBF-LD02S_CH0_ZCALREQ	BIT	1.0	Loadcell input module Channel 0 zero calibration request
Output	XBF-LD02S_CH1_ZCALREQ	BIT	1.1	Loadcell input module Channel 1 zero calibration request
Output	XBF-LD02S_CH0_SCALREQ	BIT	1.2	Loadcell input module Channel 0 span calibration request
Output	XBF-LD02S_CH1_SCALREQ	BIT	1.3	Loadcell input module Channel 1 span calibration request
Output	XBF-LD02S_CH0_CALSTORE	BIT	1.4	Loadcell input module Channel 0 save request
Output	XBF-LD02S_CH1_CALSTORE	BIT	1.5	Loadcell input module Channel 1 save request
Output	XBF-LD02S_CH0_ZSETREQ	BIT	2.0	Loadcell input module Channel 0 zero setting request
Output	XBF-LD02S_CH1_ZSETREQ	BIT	2.1	Loadcell input module Channel 1 zero setting request
Output	XBF-LD02S_CH0_ZRSTREQ	BIT	2.2	Loadcell input module Channel 0 zero reset request
Output	XBF-LD02S_CH1_ZRSTREQ	BIT	2.3	Loadcell input module Channel 1 zero reset request
Output	XBF-LD02S_CH0_TARERREQ	BIT	2.4	Loadcell input module Channel 0 tare setting
Output	XBF-LD02S_CH1_TARERREQ	BIT	2.5	Loadcell input module Channel 1 tare setting
Output	XBF-LD02S_CH0_HOLDREQ	BIT	2.6	Loadcell input module Channel 0 output hold request
Output	XBF-LD02S_CH1_HOLDREQ	BIT	2.7	Loadcell input module Channel 1 output hold request
Output	XBF-LD02S_CH0_MAXMINREQ	BIT	2.8	Loadcell input module Channel 0 Min./Max. hold request
Output	XBF-LD02S_CH1_MAXMINREQ	BIT	2.9	Loadcell input module Channel 1 Min./Max. hold request
Output	XBF-LD02S_CH0_SEQREQ	BIT	2.A	Loadcell input module Channel 0 sequential control request
Output	XBF-LD02S_CH1_SEQREQ	BIT	2.B	Loadcell input module Channel 1 sequential control request
Output	XBF-LD02S_CH0_TARERSTREQ	BIT	2.C	Loadcell input module Channel 0 tare release request
Output	XBF-LD02S_CH1_TARERSTREQ	BIT	2.D	Loadcell input module Channel 1 tare release request

A.3.3 Smart I/O block

(1) GEL-AV8C

1) U Device

Input/Output	Variable	Type	Device	Comment
Input	GEL-AV8C_ERR	BIT	Uxy.00.0	Analog input module: Module error
Input	GEL-AV8C_RDY	BIT	Uxy.00.F	Analog input module: Module ready
Input	GEL-AV8C_CH0_ACT	BIT	Uxy.01.0	Analog input module: CH0 RUN
Input	GEL-AV8C_CH1_ACT	BIT	Uxy.01.1	Analog input module: CH1 RUN
Input	GEL-AV8C_CH2_ACT	BIT	Uxy.01.2	Analog input module: CH2 RUN
Input	GEL-AV8C_CH3_ACT	BIT	Uxy.01.3	Analog input module: CH3 RUN
Input	GEL-AV8C_CH4_ACT	BIT	Uxy.01.4	Analog input module: CH4 RUN
Input	GEL-AV8C_CH5_ACT	BIT	Uxy.01.5	Analog input module: CH5 RUN
Input	GEL-AV8C_CH6_ACT	BIT	Uxy.01.6	Analog input module: CH6 RUN
Input	GEL-AV8C_CH7_ACT	BIT	Uxy.01.7	Analog input module: CH7 RUN
Input	GEL-AV8C_CH0_IDD	BIT	Uxy.10.0	Analog input module: CH0 input disconnection detection
Input	GEL-AV8C_CH1_IDD	BIT	Uxy.10.1	Analog input module: CH1 input disconnection detection

Input	GEL-AV8C_CH2_IDD	BIT	Uxy.10.2	Analog input module: CH2 input disconnection detection
Input	GEL-AV8C_CH3_IDD	BIT	Uxy.10.3	Analog input module: CH3 input disconnection detection
Input	GEL-AV8C_CH4_IDD	BIT	Uxy.10.4	Analog input module: CH4 input disconnection detection
Input	GEL-AV8C_CH5_IDD	BIT	Uxy.10.5	Analog input module: CH5 input disconnection detection
Input	GEL-AV8C_CH6_IDD	BIT	Uxy.10.6	Analog input module: CH6 input disconnection detection
Input	GEL-AV8C_CH7_IDD	BIT	Uxy.10.7	Analog input module: CH7 input disconnection detection
Output	GEL-AV8C_ERR_CLR	BIT	Uxy.11.0	Analog input module: Error clear request
Input	GEL-AV8C_CH0_HOOR	BIT	Uxy.20.0	Analog input module: Channel 0 alarm upper limit
Input	GEL-AV8C_CH1_HOOR	BIT	Uxy.20.1	Analog input module: Channel 1 alarm upper limit
Input	GEL-AV8C_CH2_HOOR	BIT	Uxy.20.2	Analog input module: Channel 2 alarm upper limit
Input	GEL-AV8C_CH3_HOOR	BIT	Uxy.20.3	Analog input module: Channel 3 alarm upper limit
Input	GEL-AV8C_CH4_HOOR	BIT	Uxy.20.4	Analog input module: Channel 4 alarm upper limit
Input	GEL-AV8C_CH5_HOOR	BIT	Uxy.20.5	Analog input module: Channel 5 alarm upper limit
Input	GEL-AV8C_CH6_HOOR	BIT	Uxy.20.6	Analog input module: Channel 6 alarm upper limit
Input	GEL-AV8C_CH7_HOOR	BIT	Uxy.20.7	Analog input module: Channel 7 alarm upper limit
Input	GEL-AV8C_CH0_LOOR	BIT	Uxy.21.0	Analog input module: Channel 0 alarm lower limit
Input	GEL-AV8C_CH1_LOOR	BIT	Uxy.21.1	Analog input module: Channel 1 alarm lower limit
Input	GEL-AV8C_CH2_LOOR	BIT	Uxy.21.2	Analog input module: Channel 2 alarm lower limit
Input	GEL-AV8C_CH3_LOOR	BIT	Uxy.21.3	Analog input module: Channel 3 alarm lower limit
Input	GEL-AV8C_CH4_LOOR	BIT	Uxy.21.4	Analog input module: Channel 4 alarm lower limit
Input	GEL-AV8C_CH5_LOOR	BIT	Uxy.21.5	Analog input module: Channel 5 alarm lower limit
Input	GEL-AV8C_CH6_LOOR	BIT	Uxy.21.6	Analog input module: Channel 6 alarm lower limit
Input	GEL-AV8C_CH7_LOOR	BIT	Uxy.21.7	Analog input module: Channel 7 alarm lower limit
Input	GEL-AV8C_CH0_DATA	Word	Uxy.02	Analog input module: CH0 conversion value
Input	GEL-AV8C_CH1_DATA	Word	Uxy.03	Analog input module: CH1 conversion value
Input	GEL-AV8C_CH2_DATA	Word	Uxy.04	Analog input module: CH2 conversion value
Input	GEL-AV8C_CH3_DATA	Word	Uxy.05	Analog input module: CH3 conversion value
Input	GEL-AV8C_CH4_DATA	Word	Uxy.06	Analog input module: CH4 conversion value
Input	GEL-AV8C_CH5_DATA	Word	Uxy.07	Analog input module: CH5 conversion value
Input	GEL-AV8C_CH6_DATA	Word	Uxy.08	Analog input module: CH6 conversion value
Input	GEL-AV8C_CH7_DATA	Word	Uxy.09	Analog input module: CH7 conversion value

2) Refresh data

<Input>

Input/Output	Variable	Type	Word(16BIT) Offset	Comment
Input	GEL-AV8C_ERR	BIT	0.0	Analog input module: Module error
Input	GEL-AV8C_RDY	BIT	0.F	Analog input module: Module ready
Input	GEL-AV8C_CH0_ACT	BIT	1.0	Analog input module: CH0 RUN
Input	GEL-AV8C_CH1_ACT	BIT	1.1	Analog input module: CH1 RUN
Input	GEL-AV8C_CH2_ACT	BIT	1.2	Analog input module: CH2 RUN
Input	GEL-AV8C_CH3_ACT	BIT	1.3	Analog input module: CH3 RUN
Input	GEL-AV8C_CH4_ACT	BIT	1.4	Analog input module: CH4 RUN
Input	GEL-AV8C_CH5_ACT	BIT	1.5	Analog input module: CH5 RUN
Input	GEL-AV8C_CH6_ACT	BIT	1.6	Analog input module: CH6 RUN
Input	GEL-AV8C_CH7_ACT	BIT	1.7	Analog input module: CH7 RUN
Input	GEL-AV8C_CH0_DATA	Word	2	Analog input module: CH0 conversion value
Input	GEL-AV8C_CH1_DATA	Word	3	Analog input module: CH1 conversion value

Appendix

Input	GEL-AV8C_CH2_DATA	Word	4	Analog input module: CH2 conversion value
Input	GEL-AV8C_CH3_DATA	Word	5	Analog input module: CH3 conversion value
Input	GEL-AV8C_CH4_DATA	Word	6	Analog input module: CH4 conversion value
Input	GEL-AV8C_CH5_DATA	Word	7	Analog input module: CH5 conversion value
Input	GEL-AV8C_CH6_DATA	Word	8	Analog input module: CH6 conversion value
Input	GEL-AV8C_CH7_DATA	Word	9	Analog input module: CH7 conversion value
Input	GEL-AV8C_CH0_IDD	BIT	10.0	Analog input module: CH0 input disconnection detection
Input	GEL-AV8C_CH1_IDD	BIT	10.1	Analog input module: CH1 input disconnection detection
Input	GEL-AV8C_CH2_IDD	BIT	10.2	Analog input module: CH2 input disconnection detection
Input	GEL-AV8C_CH3_IDD	BIT	10.3	Analog input module: CH3 input disconnection detection
Input	GEL-AV8C_CH4_IDD	BIT	10.4	Analog input module: CH4 input disconnection detection
Input	GEL-AV8C_CH5_IDD	BIT	10.5	Analog input module: CH5 input disconnection detection
Input	GEL-AV8C_CH6_IDD	BIT	10.6	Analog input module: CH6 input disconnection detection
Input	GEL-AV8C_CH7_IDD	BIT	10.7	Analog input module: CH7 input disconnection detection
Input	GEL-AV8C_CH0_HOOR	BIT	11.0	Analog input module: Channel 0 alarm upper limit
Input	GEL-AV8C_CH1_HOOR	BIT	11.1	Analog input module: Channel 1 alarm upper limit
Input	GEL-AV8C_CH2_HOOR	BIT	11.2	Analog input module: Channel 2 alarm upper limit
Input	GEL-AV8C_CH3_HOOR	BIT	11.3	Analog input module: Channel 3 alarm upper limit
Input	GEL-AV8C_CH4_HOOR	BIT	11.4	Analog input module: Channel 4 alarm upper limit
Input	GEL-AV8C_CH5_HOOR	BIT	11.5	Analog input module: Channel 5 alarm upper limit
Input	GEL-AV8C_CH6_HOOR	BIT	11.6	Analog input module: Channel 6 alarm upper limit
Input	GEL-AV8C_CH7_HOOR	BIT	11.7	Analog input module: Channel 7 alarm upper limit
Input	GEL-AV8C_CH0_LOOR	BIT	12.0	Analog input module: Channel 0 alarm lower limit
Input	GEL-AV8C_CH1_LOOR	BIT	12.1	Analog input module: Channel 1 alarm lower limit
Input	GEL-AV8C_CH2_LOOR	BIT	12.2	Analog input module: Channel 2 alarm lower limit
Input	GEL-AV8C_CH3_LOOR	BIT	12.3	Analog input module: Channel 3 alarm lower limit
Input	GEL-AV8C_CH4_LOOR	BIT	12.4	Analog input module: Channel 4 alarm lower limit
Input	GEL-AV8C_CH5_LOOR	BIT	12.5	Analog input module: Channel 5 alarm lower limit
Input	GEL-AV8C_CH6_LOOR	BIT	12.6	Analog input module: Channel 6 alarm lower limit
Input	GEL-AV8C_CH7_LOOR	BIT	12.7	Analog input module: Channel 7 alarm lower limit

<Output>

Input/Output	Variable	Type	Word(16BIT) Offset	Comment
Output	GEL-AV8C_ERR_CLR	BIT	0.0	Analog input module: Error clear request

(2) GEL-DV8C

1) U Device

Input/Output	Variable	Type	Device	Comment
Input	GEL-AC8C_ERR	BIT	Uxy.00.0	Analog input module: Module error
Input	GEL-AC8C_RDY	BIT	Uxy.00.F	Analog input module: Module ready
Input	GEL-AC8C_CH0_ACT	BIT	Uxy.01.0	Analog input module: CH0 RUN
Input	GEL-AC8C_CH1_ACT	BIT	Uxy.01.1	Analog input module: CH1 RUN
Input	GEL-AC8C_CH2_ACT	BIT	Uxy.01.2	Analog input module: CH2 RUN
Input	GEL-AC8C_CH3_ACT	BIT	Uxy.01.3	Analog input module: CH3 RUN
Input	GEL-AC8C_CH4_ACT	BIT	Uxy.01.4	Analog input module: CH4 RUN

Input	GEL-AC8C_CH5_ACT	BIT	Uxy.01.5	Analog input module: CH5 RUN
Input	GEL-AC8C_CH6_ACT	BIT	Uxy.01.6	Analog input module: CH6 RUN
Input	GEL-AC8C_CH7_ACT	BIT	Uxy.01.7	Analog input module: CH7 RUN
Input	GEL-AC8C_CH0_IDD	BIT	Uxy.10.0	Analog input module: CH0 input disconnection detection
Input	GEL-AC8C_CH1_IDD	BIT	Uxy.10.1	Analog input module: CH1 input disconnection detection
Input	GEL-AC8C_CH2_IDD	BIT	Uxy.10.2	Analog input module: CH2 input disconnection detection
Input	GEL-AC8C_CH3_IDD	BIT	Uxy.10.3	Analog input module: CH3 input disconnection detection
Input	GEL-AC8C_CH4_IDD	BIT	Uxy.10.4	Analog input module: CH4 input disconnection detection
Input	GEL-AC8C_CH5_IDD	BIT	Uxy.10.5	Analog input module: CH5 input disconnection detection
Input	GEL-AC8C_CH6_IDD	BIT	Uxy.10.6	Analog input module: CH6 input disconnection detection
Input	GEL-AC8C_CH7_IDD	BIT	Uxy.10.7	Analog input module: CH7 input disconnection detection
Output	GEL-AC8C_ERR_CLR	BIT	Uxy.11.0	Analog input module: Error clear request
Input	GEL-AC8C_CH0_HOOR	BIT	Uxy.20.0	Analog input module: Channel 0 alarm upper limit
Input	GEL-AC8C_CH1_HOOR	BIT	Uxy.20.1	Analog input module: Channel 1 alarm upper limit
Input	GEL-AC8C_CH2_HOOR	BIT	Uxy.20.2	Analog input module: Channel 2 alarm upper limit
Input	GEL-AC8C_CH3_HOOR	BIT	Uxy.20.3	Analog input module: Channel 3 alarm upper limit
Input	GEL-AC8C_CH4_HOOR	BIT	Uxy.20.4	Analog input module: Channel 4 alarm upper limit
Input	GEL-AC8C_CH5_HOOR	BIT	Uxy.20.5	Analog input module: Channel 5 alarm upper limit
Input	GEL-AC8C_CH6_HOOR	BIT	Uxy.20.6	Analog input module: Channel 6 alarm upper limit
Input	GEL-AC8C_CH7_HOOR	BIT	Uxy.20.7	Analog input module: Channel 7 alarm upper limit
Input	GEL-AC8C_CH0_LOOR	BIT	Uxy.21.0	Analog input module: Channel 0 alarm lower limit
Input	GEL-AC8C_CH1_LOOR	BIT	Uxy.21.1	Analog input module: Channel 1 alarm lower limit
Input	GEL-AC8C_CH2_LOOR	BIT	Uxy.21.2	Analog input module: Channel 2 alarm lower limit
Input	GEL-AC8C_CH3_LOOR	BIT	Uxy.21.3	Analog input module: Channel 3 alarm lower limit
Input	GEL-AC8C_CH4_LOOR	BIT	Uxy.21.4	Analog input module: Channel 4 alarm lower limit
Input	GEL-AC8C_CH5_LOOR	BIT	Uxy.21.5	Analog input module: Channel 5 alarm lower limit
Input	GEL-AC8C_CH6_LOOR	BIT	Uxy.21.6	Analog input module: Channel 6 alarm lower limit
Input	GEL-AC8C_CH7_LOOR	BIT	Uxy.21.7	Analog input module: Channel 7 alarm lower limit
Input	GEL-AC8C_CH0_DATA	Word	Uxy.02	Analog input module: CH0 conversion value
Input	GEL-AC8C_CH1_DATA	Word	Uxy.03	Analog input module: CH1 conversion value
Input	GEL-AC8C_CH2_DATA	Word	Uxy.04	Analog input module: CH2 conversion value
Input	GEL-AC8C_CH3_DATA	Word	Uxy.05	Analog input module: CH3 conversion value
Input	GEL-AC8C_CH4_DATA	Word	Uxy.06	Analog input module: CH4 conversion value
Input	GEL-AC8C_CH5_DATA	Word	Uxy.07	Analog input module: CH5 conversion value
Input	GEL-AC8C_CH6_DATA	Word	Uxy.08	Analog input module: CH6 conversion value
Input	GEL-AC8C_CH7_DATA	Word	Uxy.09	Analog input module: CH7 conversion value

2) Refresh data

<Input>

Input/Output	Variable	Type	Word(16BIT) Offset	Comment
--------------	----------	------	--------------------	---------

Appendix

Input	GEL-AC8C_ERR	BIT	0.0	Analog input module: Module error
Input	GEL-AC8C_RDY	BIT	0.F	Analog input module: Module ready
Input	GEL-AC8C_CH0_ACT	BIT	1.0	Analog input module: CH0 RUN
Input	GEL-AC8C_CH1_ACT	BIT	1.1	Analog input module: CH1 RUN
Input	GEL-AC8C_CH2_ACT	BIT	1.2	Analog input module: CH2 RUN
Input	GEL-AC8C_CH3_ACT	BIT	1.3	Analog input module: CH3 RUN
Input	GEL-AC8C_CH4_ACT	BIT	1.4	Analog input module: CH4 RUN
Input	GEL-AC8C_CH5_ACT	BIT	1.5	Analog input module: CH5 RUN
Input	GEL-AC8C_CH6_ACT	BIT	1.6	Analog input module: CH6 RUN
Input	GEL-AC8C_CH7_ACT	BIT	1.7	Analog input module: CH7 RUN
Input	GEL-AC8C_CH0_DATA	Word	2	Analog input module: CH0 conversion value
Input	GEL-AC8C_CH1_DATA	Word	3	Analog input module: CH1 conversion value
Input	GEL-AC8C_CH2_DATA	Word	4	Analog input module: CH2 conversion value
Input	GEL-AC8C_CH3_DATA	Word	5	Analog input module: CH3 conversion value
Input	GEL-AC8C_CH4_DATA	Word	6	Analog input module: CH4 conversion value
Input	GEL-AC8C_CH5_DATA	Word	7	Analog input module: CH5 conversion value
Input	GEL-AC8C_CH6_DATA	Word	8	Analog input module: CH6 conversion value
Input	GEL-AC8C_CH7_DATA	Word	9	Analog input module: CH7 conversion value
Input	GEL-AC8C_CH0_IDD	BIT	10.0	Analog input module: CH0 input disconnection detection
Input	GEL-AC8C_CH1_IDD	BIT	10.1	Analog input module: CH1 input disconnection detection
Input	GEL-AC8C_CH2_IDD	BIT	10.2	Analog input module: CH2 input disconnection detection
Input	GEL-AC8C_CH3_IDD	BIT	10.3	Analog input module: CH3 input disconnection detection
Input	GEL-AC8C_CH4_IDD	BIT	10.4	Analog input module: CH4 input disconnection detection
Input	GEL-AC8C_CH5_IDD	BIT	10.5	Analog input module: CH5 input disconnection detection
Input	GEL-AC8C_CH6_IDD	BIT	10.6	Analog input module: CH6 input disconnection detection
Input	GEL-AC8C_CH7_IDD	BIT	10.7	Analog input module: CH7 input disconnection detection
Input	GEL-AC8C_CH0_HOOR	BIT	11.0	Analog input module: Channel 0 alarm upper limit
Input	GEL-AC8C_CH1_HOOR	BIT	11.1	Analog input module: Channel 1 alarm upper limit
Input	GEL-AC8C_CH2_HOOR	BIT	11.2	Analog input module: Channel 2 alarm upper limit
Input	GEL-AC8C_CH3_HOOR	BIT	11.3	Analog input module: Channel 3 alarm upper limit
Input	GEL-AC8C_CH4_HOOR	BIT	11.4	Analog input module: Channel 4 alarm upper limit
Input	GEL-AC8C_CH5_HOOR	BIT	11.5	Analog input module: Channel 5 alarm upper limit
Input	GEL-AC8C_CH6_HOOR	BIT	11.6	Analog input module: Channel 6 alarm upper limit
Input	GEL-AC8C_CH7_HOOR	BIT	11.7	Analog input module: Channel 7 alarm upper limit
Input	GEL-AC8C_CH0_LOOR	BIT	12.0	Analog input module: Channel 0 alarm lower limit
Input	GEL-AC8C_CH1_LOOR	BIT	12.1	Analog input module: Channel 1 alarm lower limit
Input	GEL-AC8C_CH2_LOOR	BIT	12.2	Analog input module: Channel 2 alarm lower limit
Input	GEL-AC8C_CH3_LOOR	BIT	12.3	Analog input module: Channel 3 alarm lower limit
Input	GEL-AC8C_CH4_LOOR	BIT	12.4	Analog input module: Channel 4 alarm lower limit
Input	GEL-AC8C_CH5_LOOR	BIT	12.5	Analog input module: Channel 5 alarm lower limit

Input	GEL-AC8C_CH6_LOOR	BIT	12.6	Analog input module: Channel 6 alarm lower limit
Input	GEL-AC8C_CH7_LOOR	BIT	12.7	Analog input module: Channel 7 alarm lower limit

<Output>

Input/Output	Variable	Type	Word(16BIT) Offset	Comment
Output	GEL-AC8C_ERR_CLR	BIT	0.0	Analog input module: Error clear request

(3) GEL-DV4C

1) U Device

Input/Output	Variable	Type	Device	Comment
Input	GEL-DV4C_CH0_ERR	BIT	Uxy.00.0	Analog output module: Channel 0 error
Input	GEL-DV4C_CH1_ERR	BIT	Uxy.00.1	Analog output module: Channel 1 error
Input	GEL-DV4C_CH2_ERR	BIT	Uxy.00.2	Analog output module: Channel 2 error
Input	GEL-DV4C_CH3_ERR	BIT	Uxy.00.3	Analog output module: Channel 3 error
Input	GEL-DV4C_RDY	BIT	Uxy.00.F	Analog output module: Module ready
Input	GEL-DV4C_CH0_ACT	BIT	Uxy.01.0	Analog output module: CH0 RUN
Input	GEL-DV4C_CH1_ACT	BIT	Uxy.01.1	Analog output module: CH1 RUN
Input	GEL-DV4C_CH2_ACT	BIT	Uxy.01.2	Analog output module: CH2 RUN
Input	GEL-DV4C_CH3_ACT	BIT	Uxy.01.3	Analog output module: CH3 RUN
Output	GEL-DV4C_CH0_OUTEN	BIT	Uxy.02.0	Analog output module: Channel 0 output status setting
Output	GEL-DV4C_CH1_OUTEN	BIT	Uxy.02.1	Analog output module: Channel 1 output status setting
Output	GEL-DV4C_CH2_OUTEN	BIT	Uxy.02.2	Analog output module: Channel 2 output status setting
Output	GEL-DV4C_CH3_OUTEN	BIT	Uxy.02.3	Analog output module: Channel 3 output status setting
Output	GEL-DV4C_CH0_DATA	Word	Uxy.03	Analog output module: Channel 0 Input value
Output	GEL-DV4C_CH1_DATA	Word	Uxy.04	Analog output module: Channel 1 Input value
Output	GEL-DV4C_CH2_DATA	Word	Uxy.05	Analog output module: Channel 2 Input value
Output	GEL-DV4C_CH3_DATA	Word	Uxy.06	Analog output module: Channel 3 Input value

2) Refresh data

<Input>

Input/Output	Variable	Type	Word(16BIT) Offset	Comment
Input	GEL-DV4C_CH0_ERR	BIT	0.0	Analog Output module: Channel 0 error
Input	GEL-DV4C_CH1_ERR	BIT	0.1	Analog Output module: Channel 1 error
Input	GEL-DV4C_CH2_ERR	BIT	0.2	Analog Output module: Channel 2 error
Input	GEL-DV4C_CH3_ERR	BIT	0.3	Analog Output module: Channel 3 error
Input	GEL-DV4C_RDY	BIT	0.F	Analog output module: Module ready
Input	GEL-DV4C_CH0_ACT	BIT	1.0	Analog Output module: CH0 RUN
Input	GEL-DV4C_CH1_ACT	BIT	1.1	Analog Output module: CH1 RUN
Input	GEL-DV4C_CH2_ACT	BIT	1.2	Analog Output module: CH2 RUN

Appendix

Input	GEL-DV4C_CH3_ACT	BIT	1.3	Analog Output module: CH3 RUN
-------	------------------	-----	-----	-------------------------------

<Output>

Input/Output	Variable	Type	Word(16BIT) Offset	Comment
Output	GEL-DV4C_CH0_OUTEN	BIT	0.0	Analog Output module: Channel 0 output status setting
Output	GEL-DV4C_CH1_OUTEN	BIT	0.1	Analog Output module: Channel 1 output status setting
Output	GEL-DV4C_CH2_OUTEN	BIT	0.2	Analog Output module: Channel 2 output status setting
Output	GEL-DV4C_CH3_OUTEN	BIT	0.3	Analog Output module: Channel 3 output status setting
Output	GEL-DV4C_CH0_DATA	Word	1	Analog Output module: Channel 0 Input value
Output	GEL-DV4C_CH1_DATA	Word	2	Analog Output module: Channel 1 Input value
Output	GEL-DV4C_CH2_DATA	Word	3	Analog Output module: Channel 2 Input value
Output	GEL-DV4C_CH3_DATA	Word	4	Analog Output module: Channel 3 Input value
Output		WORD	5	Reserved
Output		WORD	6	Reserved
Output		WORD	7	Reserved
Output		WORD	8	Reserved
Output		WORD	9	Reserved

(4) GEL-DC4C

1) U Device

Input/Output	Variable	Type	Device	Comment
Input	GEL-DC4C_CH0_ERR	BIT	Uxy.00.0	Analog output module: Channel 0 error
Input	GEL-DC4C_CH1_ERR	BIT	Uxy.00.1	Analog output module: Channel 1 error
Input	GEL-DC4C_CH2_ERR	BIT	Uxy.00.2	Analog output module: Channel 2 error
Input	GEL-DC4C_CH3_ERR	BIT	Uxy.00.3	Analog output module: Channel 3 error
Input	GEL-DC4C_RDY	BIT	Uxy.00.F	Analog output module: Module ready
Input	GEL-DC4C_CH0_ACT	BIT	Uxy.01.0	Analog output module: CH0 RUN
Input	GEL-DC4C_CH1_ACT	BIT	Uxy.01.1	Analog output module: CH1 RUN
Input	GEL-DC4C_CH2_ACT	BIT	Uxy.01.2	Analog output module: CH2 RUN
Input	GEL-DC4C_CH3_ACT	BIT	Uxy.01.3	Analog output module: CH3 RUN
Output	GEL-DC4C_CH0_OUTEN	BIT	Uxy.02.0	Analog output module: Channel 0 output status setting
Output	GEL-DC4C_CH1_OUTEN	BIT	Uxy.02.1	Analog output module: Channel 1 output status setting
Output	GEL-DC4C_CH2_OUTEN	BIT	Uxy.02.2	Analog output module: Channel 2 output status setting
Output	GEL-DC4C_CH3_OUTEN	BIT	Uxy.02.3	Analog output module: Channel 3 output status setting
Output	GEL-DC4C_CH0_DATA	Word	Uxy.03	Analog output module: Channel 0 Input value
Output	GEL-DC4C_CH1_DATA	Word	Uxy.04	Analog output module: Channel 1 Input value
Output	GEL-DC4C_CH2_DATA	Word	Uxy.05	Analog output module: Channel 2 Input value
Output	GEL-DC4C_CH3_DATA	Word	Uxy.06	Analog output module: Channel 3 Input value

2) Refresh data

<Input>

Input/Output	Variable	Type	Word(16BIT) Offset	Comment
--------------	----------	------	--------------------	---------

Input	GEL-DC4C_CH0_ERR	BIT	0.0	Analog Output module: Channel 0 error
Input	GEL-DC4C_CH1_ERR	BIT	0.1	Analog Output module: Channel 1 error
Input	GEL-DC4C_CH2_ERR	BIT	0.2	Analog Output module: Channel 2 error
Input	GEL-DC4C_CH3_ERR	BIT	0.3	Analog Output module: Channel 3 error
Input	GEL-DC4C_RDY	BIT	0.F	Analog output module: Module ready
Input	GEL-DC4C_CH0_ACT	BIT	1.0	Analog Output module: CH0 RUN
Input	GEL-DC4C_CH1_ACT	BIT	1.1	Analog Output module: CH1 RUN
Input	GEL-DC4C_CH2_ACT	BIT	1.2	Analog Output module: CH2 RUN
Input	GEL-DC4C_CH3_ACT	BIT	1.3	Analog Output module: CH3 RUN

<Output>

Input/Output	Variable	Type	Word(16BIT) Offset	Comment
Output	GEL-DC4C_CH0_OUTEN	BIT	0.0	Analog Output module: Channel 0 output status setting
Output	GEL-DC4C_CH1_OUTEN	BIT	0.1	Analog Output module: Channel 1 output status setting
Output	GEL-DC4C_CH2_OUTEN	BIT	0.2	Analog Output module: Channel 2 output status setting
Output	GEL-DC4C_CH3_OUTEN	BIT	0.3	Analog Output module: Channel 3 output status setting
Output	GEL-DC4C_CH0_DATA	Word	1	Analog Output module: Channel 0 Input value
Output	GEL-DC4C_CH1_DATA	Word	2	Analog Output module: Channel 1 Input value
Output	GEL-DC4C_CH2_DATA	Word	3	Analog Output module: Channel 2 Input value
Output	GEL-DC4C_CH3_DATA	Word	4	Analog Output module: Channel 3 Input value
Output	-	WORD	5	Reserved
Output	-	WORD	6	Reserved
Output	-	WORD	7	Reserved
Output	-	WORD	8	Reserved
Output	-	WORD	9	Reserved

A.4 LED Status Information

The LED color (Green / Yellow / Red) in the table below indicates the LED color of the module displayed in the system diagnostics, not the color of the module LED display.

A.4.1 Extension driver

Data address [Bit]	Content	Note										
0 -1	RUN LED (Green)	<table border="1"> <thead> <tr> <th>Data</th> <th>Status</th> </tr> </thead> <tbody> <tr> <td>0</td> <td>Off</td> </tr> <tr> <td>1</td> <td>On</td> </tr> <tr> <td>2</td> <td>Blink</td> </tr> <tr> <td>3</td> <td>Reserved</td> </tr> </tbody> </table>	Data	Status	0	Off	1	On	2	Blink	3	Reserved
Data	Status											
0	Off											
1	On											
2	Blink											
3	Reserved											
2-3	RING LED (Green)											
4-5	RELAY LED (Green)											
6-7	CHK LED (Green)											
8-9	FAULT LED (Red)											
10 – 11	ERR LED (Red)											
12 - 13	LINK1 LED (Green)											
14 -15	LINK1 LED (Yellow)											
16 – 17	LINK2 LED (Green)											
18 – 19	LINK2 LED (Yellow)											
20 - 31	Reserved											

A.4.2 Smart I/O expansion

Data address [Bit]	Content	Note										
0 -1	RUN LED (Green)	<table border="1"> <thead> <tr> <th>Data</th> <th>Status</th> </tr> </thead> <tbody> <tr> <td>0</td> <td>Off</td> </tr> <tr> <td>1</td> <td>On</td> </tr> <tr> <td>2</td> <td>Blink</td> </tr> <tr> <td>3</td> <td>Reserved</td> </tr> </tbody> </table>	Data	Status	0	Off	1	On	2	Blink	3	Reserved
Data	Status											
0	Off											
1	On											
2	Blink											
3	Reserved											
2-3	RUN LED (Red)											
4-5	RMS LED (Green)											
6-7	RMS LED (Red)											
8-9	RNS LED (Green)											
10 – 11	RNS LED (Red)											
12 – 13	RELAY LED (Green)											
14 -15	Reserved											
16 – 17	LINK/ACT1 LED (Green)											
18 – 19	LINK/ACT1 LED (Yellow)											
20 – 21	LINK/ACT2 LED (Green)											
22 -23	LINK/ACT2 LED (Yellow)											
24 – 31	Reserved											

A.4.3 Smart I/O block

In the table below, the PORT LED differs from the module LED display.

In the system diagnostics, if the PORT LED is GREEN ON, the 100M link up status is displayed.

Data address [Bit]	Content	Note										
0 -1	STATUS LED (Green)	<table border="1"> <thead> <tr> <th>Data</th> <th>Status</th> </tr> </thead> <tbody> <tr> <td>0</td> <td>Off</td> </tr> <tr> <td>1</td> <td>On</td> </tr> <tr> <td>2</td> <td>Blink</td> </tr> <tr> <td>3</td> <td>Reserved</td> </tr> </tbody> </table>	Data	Status	0	Off	1	On	2	Blink	3	Reserved
Data	Status											
0	Off											
1	On											
2	Blink											
3	Reserved											
2-3	STATUS LED (Red)											
4-5	PORT1 LED (Green)											
6-7	PORT1 LED (Red)											
8-9	PORT2 LED (Green)											
10 – 11	PORT2 LED (Red)											
12 - 13	LATCH LED (Green)											
14 -15	LATCH LED (Red)											
16 – 31	Reserved											

A.5 ASCII Code Table

American National Standard Code for Information Interchange

ASCII Code		Value	ASCII Code		Value	ASCII Code		Value	ASCII Code		Value
HEX	Decimal		HEX	Decimal		HEX	Decimal		HEX	Decimal	
00	000	NULL	40	064	@	80	128	€	C0	192	À
01	001	SOH	41	065	A	81	129	•	C1	193	Á
02	002	STX	42	066	B	82	130	,	C2	194	Â
03	003	ETX	43	067	C	83	131	f	C3	195	Ã
04	004	EQT	44	068	D	84	132	„	C4	196	Ä
05	005	ENQ	45	069	E	85	133	...	C5	197	Å
06	006	ACK	46	070	F	86	134	†	C6	198	Æ
07	007	BEL	47	071	G	87	135	‡	C7	199	Ç
08	008	BS	48	072	H	88	136	^	C8	200	È
09	009	HT	49	073	I	89	137	‰	C9	201	É
0A	010	LF	4A	074	J	8A	138	Š	CA	202	Ê
0B	011	VT	4B	075	K	8B	139	‹	CB	203	Ë
0C	012	FF	4C	076	L	8C	140	Œ	CC	204	Ì
0D	013	CR	4D	077	M	8D	141	•	CD	205	Í
0E	014	SO	4E	078	N	8E	142	Ž	CE	206	Î
0F	015	SI	4F	079	O	8F	143	•	CF	207	Ï
10	016	DLE	50	080	P	90	144	•	D0	208	Ð
11	017	DC1	51	081	Q	91	145	‘	D1	209	Ñ
12	018	DC2	52	082	R	92	146	’	D2	210	Ò
13	019	DC3	53	083	S	93	147	“	D3	211	Ó
14	020	DC4	54	084	T	94	148	”	D4	212	Ô
15	021	NAK	55	085	U	95	149	•	D5	213	Õ
16	022	SYN	56	086	V	96	150	–	D6	214	Ö
17	023	ETB	57	087	W	97	151	—	D7	215	×
18	024	CAN	58	088	X	98	152	~	D8	216	Ø
19	025	EM	59	089	Y	99	153	™	D9	217	Ù
1A	026	SUB	5A	090	Z	9A	154	š	DA	218	Ú
1B	027	ESC	5B	091	[9B	155	›	DB	219	Û

ASCII Code		Value	ASCII Code		Value	ASCII Code		Value	ASCII Code		Value
HEX	Decimal		HEX	Decimal		HEX	Decimal		HEX	Decimal	
1C	028	FS	5C	092	\	9C	156	œ	DC	220	Ü
1D	029	GS	5D	093]	9D	157	•	DD	221	Ý
1E	030	RS	5E	094	^	9E	158	ž	DE	222	þ
1F	031	US	5F	095	_	9F	159	ÿ	DF	223	ß
20	032	(space)	60	096	`	A0	160		E0	224	à
21	033	!	61	097	a	A1	161	ı	E1	225	á
22	034	"	62	098	b	A2	162	ç	E2	226	â
23	035	#	63	099	c	A3	163	£	E3	227	ã
24	036	\$	64	100	d	A4	164	¤	E4	228	ä
25	037	%	65	101	e	A5	165	¥	E5	229	å
26	038	&	66	102	f	A6	166	ı	E9	230	æ
27	039	'	67	103	g	A7	167	§	EA	231	ç
28	040	(68	104	h	A8	168	¨	EB	232	è
29	041)	69	105	i	A9	169	©	EC	233	é
2A	042	*	6A	106	j	AA	170	ª	ED	234	ê
2B	043	+	6B	107	k	AB	171	«	EE	235	ë
2C	044	`	6C	108	l	AC	172	¬	EF	236	ì
2D	045	-	6D	109	m	AD	173		F0	237	í
2E	046	.	6E	110	n	AE	174	®	F1	238	î
2F	047	/	6F	111	o	AF	175	¯	F2	239	ï
30	048	0	70	112	p	B0	176	°	F3	240	ð
31	049	1	71	113	q	B1	177	±	F4	241	ñ
32	050	2	72	114	r	B2	178	²	F5	242	ò
33	051	3	73	115	s	B3	179	³	F6	243	ó
34	052	4	74	116	t	B4	180	´	F7	244	ô
35	053	5	75	117	u	B5	181	µ	F8	245	õ
36	054	6	76	118	v	B6	182	¶	F9	246	ö
37	055	7	77	119	w	B7	183	·	FA	247	÷
38	056	8	78	120	x	B8	184	¸	FB	248	ø
39	057	9	79	121	y	B9	185	¹	FC	249	ù
3A	058	:	7A	122	z	BA	186	º	FD	250	ú

ASCII Code		Value	ASCII Code		Value	ASCII Code		Value	ASCII Code		Value
HEX	Decimal		HEX	Decimal		HEX	Decimal		HEX	Decimal	
3B	059	;	7B	123	{	BB	187	»	FE	251	û
3C	060	<	7C	124		BC	188	½	FF	252	ü
3D	061	=	7D	125	}	BD	189	¾	EF	253	ý
3E	062	>	7E	126	~	BE	190	¿	EF	254	þ
3F	063	?	7F	127	•	BF	191	À	EF	255	ÿ

A.6 Ethernet technology compare table

technology		Speed (Mbps)	Media	Max. distance
Token Ring		4,16	UTP	100m
Ethernet	10BASE-T	10	UTP	100m
	10BASE-F(Multi mode)	10	Optical cable	Max. 2km
	10BASE-F(Single mode)	10	Optical cable	Max. 2.5km
	10BASE-5	10	Coaxial cable	500m
	10BASE-2	10	Coaxial cable	185m
Fast Ethernet	100BASE-T4	100	UTP	100m
	100BASE-TX	100	UTP	100m
	100BASE-FX(Multi mode)	100	Optical cable	412m(Half Duplex) 2km(Full Duplex)
	100BASE-FX(Single mode)	100	Optical cable	20km
Gigabit Ethernet	1000BASE-T	1000	UTP	100m
	100BASE-FX(Single mode)	1000	Optical cable	3km
	100BASE-FX(Multi mode)	1000	Optical cable	500m
	100BASE-T	1000	Coaxial cable	25m
100VG-AnyLAN		100	UTP	-
ATM		155-622	UTP,Optical cable	-
FDDI(Single mode)		100	Optical cable	40-60km
FDDI(Multi mode)		100	Optical cable	2km

A.7 External dimension (mm)

(1) XGL-DBDT/DBDH/DBDF

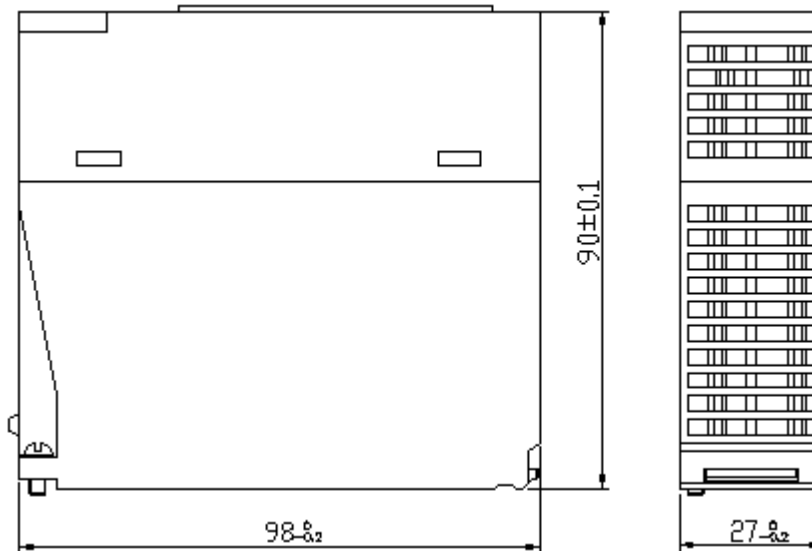

(2) XEL-BSSRT/BSSRH/BSSRF

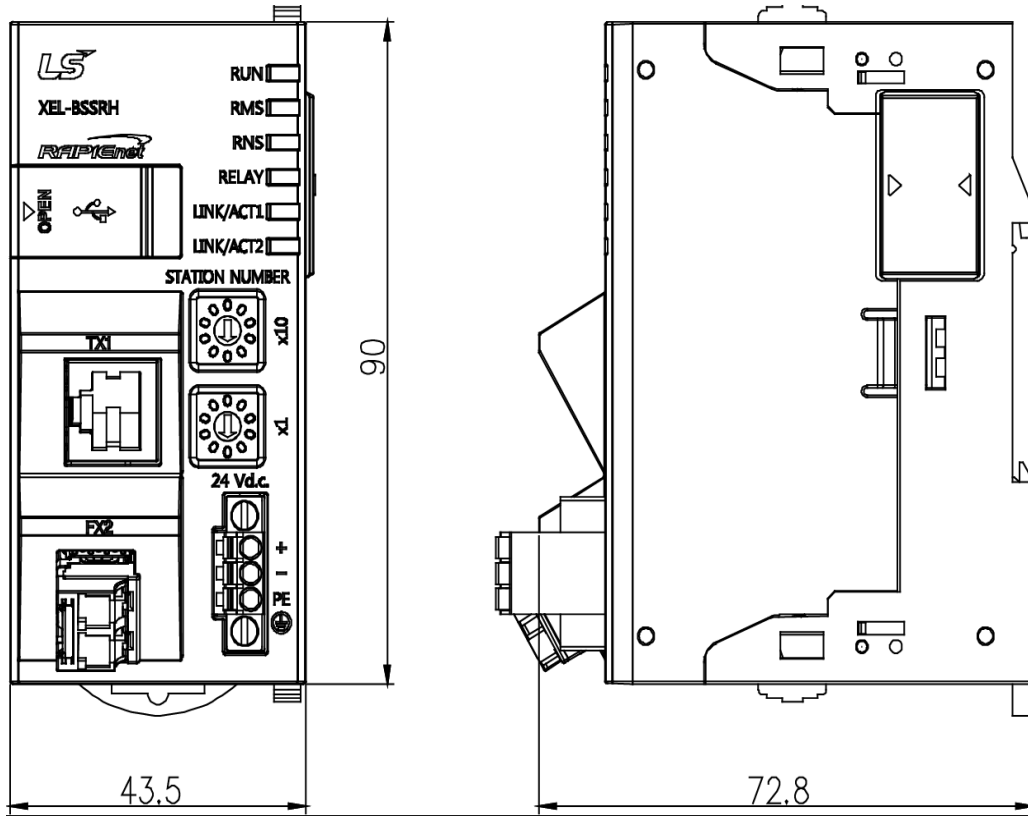

(3) GEL-TR4C/TR4C1/DT4C/DT4C1/D24C/RV2C/AV8C/AC8C/DV4C,DC4C

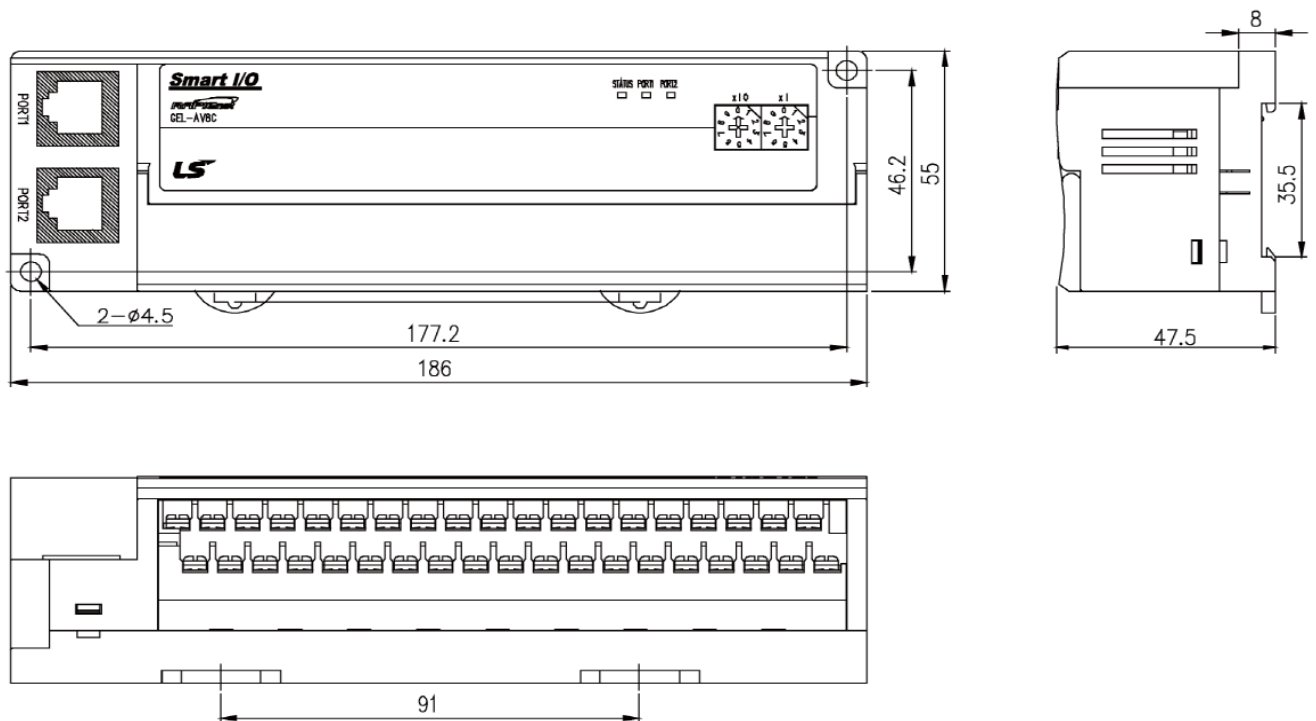

Warranty

1. Warranty Period

The product you purchased will be guaranteed for 18 months from the date of manufacturing.

2. Scope of Warranty

Any trouble or defect occurring for the above-mentioned period will be partially replaced or repaired. However, please note the following cases will be excluded from the scope of warranty.

- (1) Any trouble attributable to unreasonable condition, environment or handling otherwise specified in the manual,
- (2) Any trouble attributable to others' products,
- (3) If the product is modified or repaired in any other place not designated by the company,
- (4) Due to unintended purposes
- (5) Owing to the reasons unexpected at the level of the contemporary science and technology when delivered.
- (6) Not attributable to the company; for instance, natural disasters or fire

3. Since the above warranty is limited to PLC unit only, make sure to use the product considering the safety for system configuration or applications.

Environmental Policy

LS ELECTRIC Co., Ltd supports and observes the environmental policy as below.

Environmental Management

LS ELECTRIC considers the environmental preservation as the preferential management subject and every staff of LS ELECTRIC use the reasonable endeavors for the pleasurable environmental preservation of the earth.

About Disposal

LS ELECTRIC' PLC unit is designed to protect the environment. For the disposal, separate aluminum, iron and synthetic resin (cover) from the product as they are reusable.



www.ls-electric.com

LS ELECTRIC Co., Ltd.

■ Headquarter

LS-ro 127(Hogye-dong) Dongan-gu, Anyang-si, Gyeonggi-Do, 14119, Korea

■ Seoul Office

LS Yongsan Tower, 92, Hangang-daero, Yongsan-gu, Seoul, 04386, Korea

Tel: 82-2-2034-4033, 4888, 4703 Fax: 82-2-2034-4588

E-mail: automation@ls-electric.com

■ Overseas Subsidiaries

• LS ELECTRIC Japan Co., Ltd. (Tokyo, Japan)

Tel: 81-3-6268-8241 E-Mail: japan@ls-electric.com

• LS ELECTRIC (Dalian) Co., Ltd. (Dalian, China)

Tel: 86-411-8730-6495 E-Mail: china.dalian@lselectric.com.cn

• LS ELECTRIC (Wuxi) Co., Ltd. (Wuxi, China)

Tel: 86-510-6851-6666 E-Mail: china.wuxi@lselectric.com.cn

• LS ELECTRIC Middle East FZE (Dubai, U.A.E.)

Tel: 971-4-886-5360 E-Mail: middleeast@ls-electric.com

• LS ELECTRIC Europe B.V. (Hoofddorp, Netherlands)

Tel: 31-20-654-1424 E-Mail: europartner@ls-electric.com

• LS ELECTRIC America Inc. (Chicago, USA)

Tel: 1-800-891-2941 E-Mail: sales.us@lselectricamerica.com

• LS ELECTRIC Turkey Co., Ltd.

Tel: 90-212-806-1225 E-Mail: turkey@ls-electric.com

■ Overseas Branches

• LS ELECTRIC Tokyo Office (Japan)

Tel: 81-3-6268-8241 E-Mail: tokyo@ls-electric.com

• LS ELECTRIC Beijing Office (China)

Tel: 86-10-5095-1631 E-Mail: china.auto@lselectric.com.cn

• LS ELECTRIC Shanghai Office (China)

Tel: 86-21-5237-9977 E-Mail: china.auto@lselectric.com.cn

• LS ELECTRIC Guangzhou Office (China)

Tel: 86-20-3818-2883 E-Mail: china.auto@lselectric.com.cn

• LS ELECTRIC Chengdu Office (China)

Tel: 86-28-8670-3201 E-Mail: china.auto@lselectric.com.cn

• LS ELECTRIC Qingdao Office (China)

Tel: 86-532-8501-2065 E-Mail: china.auto@lselectric.com.cn

• LS ELECTRIC Nanjing Office (China)

Tel: 86-25-8467-0005 E-Mail: china.auto@lselectric.com.cn

• LS ELECTRIC Bangkok Office (Thailand)

Tel: 66-90-950-9683 E-Mail: thailand@ls-electric.com

• LS ELECTRIC Jakarta Office (Indonesia)

Tel: 62-21-2933-7614 E-Mail: indonesia@ls-electric.com

• LS ELECTRIC Moscow Office (Russia)

Tel: 7-499-682-6130 E-Mail: info@lselectric-ru.com

• LS ELECTRIC America Western Office (Irvine, USA)

Tel: 1-949-333-3140 E-Mail: america@ls-electric.com

Disclaimer of Liability

LS ELECTRIC has reviewed the information in this publication to ensure consistency with the hardware and software described. However, LS ELECTRIC cannot guarantee full consistency, nor be responsible for any damages or compensation, since variance cannot be precluded entirely. Please check again the version of this publication before you use the product.

© LS ELECTRIC Co., Ltd 2015 All Right Reserved.

2022.10