

The right choice for the ultimate yield!

LS ELECTRIC strives to maximize your profits in gratitude for choosing us as your partner.

Programmable Logic Control

Network Positioning Module

XGT Series

User's Manual

XBF-PN04B

XBF-PN08B



Safety Instructions

- Read this manual carefully before installing, wiring, operating, servicing or inspecting this equipment.
- Keep this manual within easy reach for quick reference.

LS ELECTRIC

Before using the product ...

For your safety and effective operation, please read the safety instructions thoroughly before using the product.

- ▶ Safety Instructions should always be observed in order to prevent accident or risk with the safe and proper use the product.
- ▶ Instructions are divided into “Warning” and “Caution”, and the meaning of the terms is as follows.



This symbol indicates the user is expected risk of death or serious injury in case of incorrect handling



This symbol indicates the user is expected risk of injury or property damage only in case of incorrect handling

Moreover, even classified events under its caution category may develop into serious accidents relying on situations. Therefore we strongly advise users to observe all precautions properly just like warnings.

- ▶ The marks displayed on the product and in the user’s manual have the following meanings.

 Be careful! Danger may be expected.

 Be careful! Electric shock may occur.

- ▶ The user’s manual even after read shall be kept available and accessible to any user of the product.

Safety Instructions for design process

Warning

- ▶ **Please install a protection circuit on the exterior of PLC so that the whole system may operate safely regardless of failures from external power or PLC.** Any abnormal output or operation from PLC may cause serious problems to safety in whole system.
 - Install protection units on the exterior of PLC like an interlock circuit that deals with opposite operations such as emergency stop, protection circuit, and forward/reverse rotation or install an interlock circuit that deals with high/low limit under its position controls.
 - If any system error (watch-dog timer error, module installation error, etc.) is detected during CPU operation in PLC, all output signals are designed to be turned off and stopped for safety. However, there are cases when output signals remain active due to device failures in Relay and TR which can't be detected. Thus, you are recommended to install an addition circuit to monitor the output status for those critical outputs which may cause significant problems.

- ▶ **Never overload more than rated current of output module nor allow to have a short circuit.** Over current for a long period time may cause a fire.

- ▶ **Never let the external power of the output circuit to be on earlier than PLC power,** which may cause accidents from abnormal output or operation.

- ▶ **Please install interlock circuits in the sequence program for safe operations in the system when exchange data with PLC or modify operation modes using a computer or other external equipments** Read specific instructions thoroughly when conducting control operations with PLC.

Safety Instructions for design process

Caution

- ▶ **I/O signal or communication line shall be wired at least 100mm away from a high-voltage cable or power line.** Fail to follow this instruction may cause malfunctions from noise

Safety Instructions on installation process

Caution

- ▶ **Use PLC only in the environment specified in PLC manual or general standard of data sheet.** If not, electric shock, fire, abnormal operation of the product may be caused.
- ▶ **Before install or remove the module, be sure PLC power is off.** If not, electric shock or damage on the product may be caused.
- ▶ **Be sure that every module is securely attached after adding a module or an extension connector.** If the product is installed loosely or incorrectly, abnormal operation, error or dropping may be caused. In addition, contact failures under poor cable installation will be causing malfunctions as well.
- ▶ **Be sure that screws get tighten securely under vibrating environments.** Fail to do so will put the product under direct vibrations which will cause electric shock, fire and abnormal operation.
- ▶ **Do not come in contact with conducting parts in each module,** which may cause electric shock, malfunctions or abnormal operation.

Safety Instructions for wiring process

Warning

- ▶ **Prior to wiring works, make sure that every power is turned off.** If not, electric shock or damage on the product may be caused.
- ▶ **After wiring process is done, make sure that terminal covers are installed properly before its use.** Fail to install the cover may cause electric shocks.

Caution

- ▶ **Check rated voltages and terminal arrangements in each product prior to its wiring process.** Applying incorrect voltages other than rated voltages and misarrangement among terminals may cause fire or malfunctions.
- ▶ **Secure terminal screws tightly applying with specified torque.** If the screws get loose, short circuit, fire or abnormal operation may be caused. Securing screws too tightly will cause damages to the module or malfunctions, short circuit, and dropping.
- ▶ **Be sure to earth to the ground using Class 3 wires for PE terminals which is exclusively used for PLC.** If the terminals not grounded correctly, abnormal operation or electric shock may be caused.
- ▶ **Don't let any foreign materials such as wiring waste inside the module while wiring,** which may cause fire, damage on the product or abnormal operation.
- ▶ **Make sure that pressed terminals get tighten following the specified torque. External connector type shall be pressed or soldered using proper equipments.**

Safety Instructions for test-operation and maintenance

Warning

- ▶ **Don't touch the terminal when powered.** Electric shock or abnormal operation may occur.
- ▶ **Prior to cleaning or tightening the terminal screws, let all the external power off including PLC power.** If not, electric shock or abnormal operation may occur.
- ▶ **Don't let the battery recharged, disassembled, heated, short or soldered.** Heat, explosion or ignition may cause injuries or fire.

Caution

- ▶ **Do not make modifications or disassemble each module.** Fire, electric shock or abnormal operation may occur.
- ▶ **Prior to installing or disassembling the module, let all the external power off including PLC power.** If not, electric shock or abnormal operation may occur.
- ▶ **Keep any wireless equipment such as walkie-talkie or cell phones at least 30cm away from PLC.** If not, abnormal operation may be caused.
- ▶ **When making a modification on programs or using run to modify functions under PLC operations, read and comprehend all contents in the manual fully.** Mismanagement will cause damages to products and accidents.
- ▶ **Avoid any physical impact to the battery and prevent it from dropping as well.** Damages to battery may cause leakage from its fluid. When battery was dropped or exposed under strong impact, never reuse the battery again. Moreover skilled workers are needed when exchanging batteries.

Safety Instructions for waste disposal



Caution

- ▶ **Product or battery waste shall be processed as industrial waste.** The waste may discharge toxic materials or explode itself.

Revision History

Version	Date	Remark	Revised position
V 1.0	2015.2	First Edition	-
V1.1	2015.4	XBF-PN04B module added	-
V1.2	2015.7	Domain address and CI changed General specifications changed by reason of changed IEC specifications	- 2-1
V1.3	2016.8	Chapter4 Basic parameter - axis type: virtual axis is added	4-2, 4-7, 4-8
		Chapter4 Input Signal Parameter is added	4-27
		Chapter4 Input filter of external input signal is revised	4-34, 4-35
		Chapter5 Operation Stats Bit info. is revised	5-7
		Chapter5 User define position/speed is revised	5-10
		Chapter6 Command: XSTC is added	6-87
		Chapter6 Command: PHASING is added	6-89
		Chapter6 Command: XSSSD is added	6-91
		Chapter6 Command: XSSSPD is added	6-93
		Chapter7 Command: XPM_STC is added	7-44
		Chapter7 Command: XPM_PHASING is added	7-45
		Chapter7 Command: XPM_SSSD is added	7-46
		Chapter7 Command: XPM_SSSPD is added	7-47
		Chapter9 Phasing correction control is added	9-174
Chapter9 User defined position/speed display is added	9-177		
Chapter9 Basic Parameter Teaching - virtual axis is added	9-186		
Chapter9 Full-closed control is added	9-188		
		OS Ver. information for each CMD is included.	-
		Appendix 1 - Error code 741~776, 811, 821 is added	A1-2
		Appendix 5 Virtual Axis is added	A5-1
V1.4	2018.8	Chapter3 L7NH Servo connect information is added	3-4
		Chapter6 Command: XSETOVR is added	6-95
		Chapter6 Command: XCAMA is added	6-97
		Chapter7 Command: XPM_SETOVR is added	7-50
		Chapter7 Command: XPM_CAMA is added	7-52
		Chapter9 Speed Acc./Dec. override is added	9-168
		Chapter9 Absolute positioning CAM operation is added	9-147
Chapter5 External input signal modified	5-5		
V1.7	-	Version management of Network Position Module	-

Version	Date	Remark	Revised position
V1.8	2019.7	Chapter2 Wiring information has added	2-7
		Chapter5 axis information added	5-9
		Chapter6 Command: XTPROBE is added	6-103
		Chapter6 Command: XABORTT is added	6-105
		Chapter6 Command: XTRQSL is added	6-106
		Chapter6 Command: XGEARIP is added	6-107
		Chapter7 Function Block: XPM_TPROBE is added	7-73
		Chapter7 Function Block: XPM_ABORTT is added	7-75
		Chapter7 Function Block: XTRQSL is added	7-36
		Chapter7 Function Block: XGEARIP is added	7-51
		Chapter9 Command: TouchProbe is added	9-184
		Chapter9 Command: Syn.SpeedDesignatingSync.Position are added	9-149
		Chapter9 Command: Homing method (0x6098) modified	9-3~7
APPENDIX 1 Error code 752~756, 791, 792 is add	App1		
V1.9	2020.7	Format and contents modification according to the change of company name(LSIS → LS ELECTRIC)	-

Thank you for purchasing PLC of LS ELECTRIC Co., Ltd.

Before use, make sure to carefully read and understand the User's Manual about the functions, performances, installation and programming of the product you purchased in order for correct use and importantly, let the end user and maintenance administrator to be provided with the User's Manual.

The User's Manual describes the product. If necessary, you may refer to the following description and order accordingly. In addition, you may connect our website (<http://www.lselectric.co.kr/>) and download the information as a PDF file.

Relevant User's Manuals

Title	Description
XG5000 User's Manual (for XGK, XGB)	XG5000 software user manual describing online function such as programming, print, monitoring, debugging by using XGK, XGB CPU
XGK/XGB Instructions & Programming User's Manual	User's manual for programming to explain how to use instructions that are used PLC system with XGK, XGB CPU.
XGB Hardware User's Manual	It describes how to use the specification of power/input /output/expansion modules, system configuration and built-in High-speed counter for XGB main unit.
XGB IEC Hardware User's Manual	It describes how to use the specification of power/input /output/expansion modules, system configuration and built-in High-speed counter for XGB IEC main unit.
XG-PM Manual	Describes the function and handling methods of XG-PM that is the software operating the positioning module corresponding to the CPU of XGT PLC series.

The User's Manual is based on XBF-PN08B.

This manual is based on the following versions.

Product name	OS version
XBF-PN08B/PN04B	V1.80
XBCU	V1.90
XECU	V1.90
XBMHP,XBMH2	V2.20
XEMHP,XEMH2	V2.20
XG5000(XG-PM:V2.8)	V4.29

◎ Table of Content ◎

Chapter 1 Overview.....	1-1 ~ 1-11
1.1 Characteristics	1 - 1
1.2 Purpose of Positioning Control	1 - 3
1.3 Function Overview of Positioning Module.....	1 - 4
1.3.1 Positioning Control.....	1 - 4
1.3.2 Interpolation Control.....	1 - 5
1.3.3 Speed Control.....	1 - 10
1.3.4 FEED Control.....	1 - 11
Chapter 2 Specification.....	2-1 ~ 2-7
2.1 General Specification	2 - 1
2.2 Performance Specifications	2 - 2
2.2.1 Function Specifications	2 - 2
2.2.2 Encoder Input Specifications	2 - 4
2.3 The Name of Each Part	2 - 5
2.3.1 The Name of Each Part	2 - 5
2.3.2 Specification of interface with external device.....	2 - 6
Chapter 3 Operation Order and Installation.....	3-1 ~ 3-9
3.1 Operation Order.....	3 - 1
3.2 Installation	3 - 2
3.2.1 Installation Environment	3 - 2
3.2.2 Notice in Handling	3 - 2
3.3 Notice in Wiring	3 - 3
3.3.1 Notice in Wiring	3 - 3
3.3.2 Connection Example of Servo and Stepping Motor Drive Machine	3 - 4
3.3.3 Encoder Input (DC 5V Voltage Output) Wiring Example.....	3 - 6
3.3.4 Encoder Input (DC 5V Line Driver Output) Wiring Example	3 - 7
3.3.5 Encoder Input (5V Line Driver Output) Wiring Example.....	3 - 9

Chapter 4 Positioning Parameter & Operation Data.....	4-1 ~ 4-39
4.1 Parameter & Operation Data	4 - 1
4.2 Basic Parameter	4 - 2
4.2.1 Basic Parameter.....	4 - 2
4.2.2 Basic Parameter Setting.....	4 - 3
4.3 Expansion Parameter	4 - 7
4.3.1 Contents of Expansion Parameter	4 - 7
4.3.2 Expansion Parameter Setting.....	4 - 8
4.4 Manual Operation Parameter	4 - 24
4.4.1 Manual Operation Parameter.....	4 - 24
4.4.2 Manual Operation Parameter Setting.....	4 - 24
4.5 Input Signal Parameter.....	4 - 25
4.5.1 Input Signal Parameter	4 - 25
4.5.2 Input Signal Parameter Setting.....	4 - 26
4.6 Common Parameter.....	4 - 27
4.6.1 Common Parameter	4 - 27
4.6.2 Common Parameter Setting.....	4 - 28
4.7 Operation Data	4 - 31
4.7.1 Operation Data	4 - 34
4.7.2 Operation Data Setting	4 - 35
Chapter 5 Internal Memory and I/O Signal.....	5-1 ~ 5-13
5.1 Internal Memory.....	5 - 1
5.1.1 Step Data during Point Start	5 - 1
5.1.2 Teaching Data	5 - 2
5.1.3 Step Data of Simultaneous Start.....	5 - 3
5.1.4 State Information.....	5 - 4
5.2 I/O Signal	5 - 11
5.2.1 Contents of I/O Signal.....	5 - 11
5.2.2 Use of I/O Signal	5 - 12

Chapter 6 Command.....	6-1 ~ 6-108
6.1 Contents of General Command	6 - 1
6.1.1 Internal Memory Read (GET, GETP Command)	6 - 1
6.1.2 Internal Memory Write (PUT, PUTP Command)	6 - 2
6.2 Dedicated Commands	6 - 3
6.3 Use of Dedicated Command	6 - 6
6.3.1 Homing start (Command: XORG)	6 - 7
6.3.2 Floating origin setting (Command: XFLT).....	6 - 8
6.3.3 Direct start (Command: XDST).....	6 - 9
6.3.4 Indirect start (Command: XIST)	6 - 10
6.3.5 Simultaneous Start (Command: XSST)	6 - 11
6.3.6 Simultaneous Start Step Setting (Command: XSWR)	6 - 13
6.3.7 Ellipse Interpolation (Command: XELIN).....	6 - 14
6.3.8 Speed/Position Switching Control (Command: XVTP).....	6 - 15
6.3.9 Position specified Speed/Position Switching Control (Command: XVTPP)	6 - 16
6.3.10 Position/Speed Switching Control (Command: XPTV)	6 - 17
6.3.11 Position/Torque Switching Control (Command: XPTT).....	6 - 18
6.3.12 Deceleration Stop (Command: XSTP)	6 - 19
6.3.13 Skip Operation (Command: XSKP).....	6 - 20
6.3.14 Synchronous Start by Position (Command: XSSP)	6 - 21
6.3.15 Speed Sync (Command: XSSS)	6 - 22
6.3.16 Position-specified Speed synch (Command: XSSSP).....	6 - 23
6.3.17 CAM Operation (Command: XCAM).....	6 - 25
6.3.18 Main axis offset-designated CAM Operation (Command: XCAMO).....	6 - 26
6.3.19 Position Override (Command: XPOR)	6 - 28
6.3.20 Speed Override (Command: XSOR)	6 - 29
6.3.21 Position-specified Speed Override (Command: XPSO).....	6 - 30
6.3.22 Continuous Operation (Command: XNMV)	6 - 31
6.3.23 Inching Operation (Command: XINCH)	6 - 32
6.3.24 Return to the Position before Manual Operation (Command: XRTP)	6 - 33
6.3.25 Start Step No. Change (Command: XSNS).....	6 - 34
6.3.26 Repeat Step No. Change (Command: XSRS)	6 - 35
6.3.27 M code Release (Command: XMOF)	6 - 36

6.3.28 Current Position Preset (Command: XPRS).....	6 - 37
6.3.29 Encoder Preset (Command: XEPRS).....	6 - 38
6.3.30 Teaching Array (Command: XTEAA).....	6 - 39
6.3.31 Set Teaching Array Data (Command: XTWR)	6 - 40
6.3.32 Set Basic Parameter (Command: XSBP)	6 - 42
6.3.33 Set Extended Parameter (Command: XSEP)	6 - 47
6.3.34 Set Parameter of Manual Operation (Command: XSMP).....	6 - 51
6.3.35 Input signal parameter teaching (Command: XSES)	6 - 54
6.3.36 Input signal parameter – Switching torque of external position/torque control teaching (Command: XSEST)	6 - 56
6.3.37 Set Common Parameter (Command: XSCP)	6 - 57
6.3.38 Set Operation Data (Command: XSMD).....	6 - 60
6.3.39 Read Variable Data (Command: XVRD)	6 - 64
6.3.40 Write Variable Data (Command: XVWR).....	6 - 66
6.3.41 Save Parameter/Operation Data (Command: XWRT).....	6 - 68
6.3.42 Emergency Stop (Command: XEMG)	6 - 69
6.3.43 Reset Error (Command: XCLR)	6 - 70
6.3.44 Reset Error History (Command: XECLR)	6 - 71
6.3.45 Point Start (Command: XPST).....	6 - 72
6.3.46 Set Step Data of POINT Start (Command: XPWR)	6 - 73
6.3.47 Read Operation State (Command: XSRD).....	6 - 75
6.3.48 Connect servo (Command: XECON).....	6 - 76
6.3.49 Disconnect Servo (Command: XDCON)	6 - 77
6.3.50 Servo On (Command: XSVON)	6 - 78
6.3.51 Servo Off (Command: XSVOFF).....	6 - 79
6.3.52 Reset Servo Error (Command: XSCLR).....	6 - 80
6.3.53 Reset History of Servo Error (Command: XSECLR).....	6 - 81
6.3.54 Restart (Command: XRSTR).....	6 - 82
6.3.55 Read Servo Parameter (Command: XSVPRD)	6 - 83
6.3.56 Write Servo Parameter (Command: XSVPWR).....	6 - 86
6.3.57 Save Servo Parameter to EEPROM (Command: XSVSAVE).....	6 - 87
6.3.58 Control Torque (Command: XTRQ)	6 - 88
6.3.59 Read Latch position data (Command: XLRD)	6 - 89
6.3.60 Reset Latch (Command: XLCLR)	6 - 90
6.3.61 Set Latch (Command: XLSET).....	6 - 91

6.3.62 Torque synchronous (Command: XSTC) 6 - 92

6.3.63 Phasing Correction (Command: XPHASING) 6 - 93

6.3.64 32bit Speed Sync (Command: XSSSD) 6 - 95

6.3.65 32bit Position-specified Speed synch (Command: XSSSPD) 6 - 97

Chapter 7 Function Block 7-1 ~ 7-84

7.1 Common Issues of Function Block 7 - 1

7.2 Function Block of Positioning Module 7 - 3

7.3 Function Blocks related to Module Information Read 7 - 6

 7.3.1 Operation Information Read (XPM_CRD) 7 - 6

 7.3.2 Operation State Read (XPM_SRD) 7 - 7

 7.3.3 Encoder Value Read (XPM_ENCRD) 7 - 9

 7.3.4 Servo Error Information Read (XPM_SVERD) 7 - 10

 7.3.5 Latch Position Data Read (XPM_LRD) 7 - 11

7.4 Parameter/Operation Data Teaching Function Blocks 7 - 12

 7.4.1 Basic Parameter Teaching (XPM_SBP) 7 - 12

 7.4.2 Extended Parameter Teaching (XPM_SEP) 7 - 14

 7.4.3 Manual Operation Parameter Teaching (XPM_SMP) 7 - 16

 7.4.4 Input signal parameter Teaching (XPM_SIP) 7 - 17

 7.4.5 Input signal parameter - Switching torque of external position/torque control Teaching (XPM_SIPT) 7 - 18

 7.4.6 Common Parameter Teaching (XPM_SCP) 7 - 19

 7.4.7 Operation Data Teaching (XPM_SMD) 7 - 20

 7.4.8 Teaching Array (XPM_ATEA) 7 - 22

 7.4.9 Read Variable Data (XPM_VRD) 7 - 23

 7.4.10 Write Variable Data (XPM_VWR) 7 - 24

 7.4.11 Saving Parameter/Operation Data (XPM_WRT) 7 - 25

7.5 Start/Stop Function Blocks 7 - 26

 7.5.1 Homing Start (XPM_ORG) 7 - 26

 7.5.2 Direct Start (XPM_DST) 7 - 27

 7.5.3 Indirect Start (XPM_IST) 7 - 28

 7.5.4 Ellipse Interpolation (XPM_ELIN) 7 - 29

 7.5.5 Simultaneous Start (XPM_SST) 7 - 30

 7.5.6 Point Start (XPM_PST) 7 - 31

7.5.7 Deceleration Stop (XPM_STP)	7 - 32
7.5.8 Emergency Stop (XPM_EMG)	7 - 33
7.5.9 Restart (XPM_RSTR).....	7 - 34
7.5.10 Torque Control (XPM_TRQ).....	7 - 35
7.5.11 Control Speed Limit Torque (XPM_TRQSL)	7 - 36
7.6 Manual Operation Function Blocks.....	7 - 37
7.6.1 JOG Operation (XPM_JOG).....	7 - 37
7.6.2 Inching Operation (XPM_INC)	7 - 38
7.6.3 Returning to Position before Manual Operation (XPM_RTP)	7 - 39
7.7 Synchronization Start Function Blocks	7 - 40
7.7.1 Position Synchronization (XPM_SSP).....	7 - 40
7.7.2 Speed Synchronization (XPM_SSS).....	7 - 41
7.7.3 Position Assigned Speed Synchronization (XPM_SSSP)	7 - 42
7.7.4 CAM Operation (XPM_CAM)	7 - 43
7.7.5 Main Axis Offset-specified CAM Operation (XPM_CAMO)	7 - 44
7.7.6 Torque synchronous (XPM_XSTC)	7 - 45
7.7.7 Phase Correction (XPM_PHASING).....	7 - 46
7.7.8 32Bit Rate Synchronization (XPM_SSSD).....	7 - 47
7.7.9 32 Bit Positioning Speed Synchronization (XPM_SSSPD).....	7 - 48
7.7.10 Absolute positioning CAM operation (XPM_CAMA)	7 - 49
7.7.11 Synchronous speed designating synchronous position (XPM_GEARIP).....	7 - 51
7.8 Modification Function Blocks.....	7 - 52
7.8.1 Position Override (XPM_POR)	7 - 52
7.8.2 Speed Override (XPM_SOR)	7 - 53
7.8.3 Position Assigned Speed Override (XPM_PSO).....	7 - 54
7.8.4 Position/Speed Switching Control (XPM_PTV)	7 - 55
7.8.5 Speed/Position Switching Control (XPM_VTP)	7 - 56
7.8.6 Position-specified Speed/Position Switching Control (XPM_VTPP).....	7 - 57
7.8.7 Position/Torque Switching Control (XPM_PTT).....	7 - 58
7.8.8 Skip Operation (XPM_SKP).....	7 - 59
7.8.9 Continuous Operation (XPM_NMV).....	7 - 60
7.8.10 Start Step Number Change (XPM_SNS).....	7 - 61
7.8.11 Repeat Step No. Change (XPM_SRS).....	7 - 62
7.8.12 Current Position Change (XPM_PRS).....	7 - 63

7.8.13 Encoder Value Preset (XPM_EPRES).....	7 - 64
7.8.14 Speed Acceleration/Deceleration override (XPM_SETOVR).....	7 - 65
7.9 Error Function Blocks	7 - 66
7.9.1 Error Reset (XPM_RST)	7 - 66
7.9.2 Error History Reset (XPM_HRST).....	7 - 67
7.10 Other Function Blocks related with the Module	7 - 68
7.10.1 Floating Origin Setting (XPM_FLT).....	7 - 68
7.10.2 M code Release (XPM_MOF)	7 - 69
7.10.3 Latch Reset (XPM_LCLR)	7 - 70
7.10.4 Latch set (XPM_LSET)	7 - 71
7.10.5 Touch Probe (XPM_TPROBE)	7 - 72
7.10.6 Trigger Abortion (XPM_ABORTT).....	7 - 74
7.11 Other Function Blocks related with the Servo Driver	7 - 75
7.11.1 Servo Communication Connect (XPM_ECON).....	7 - 75
7.11.2 Servo Communication Disconnect (XPM_DCON).....	7 - 76
7.11.3 Servo On (XPM_SVON)	7 - 77
7.11.4 Servo Off (XPM_SVOFF)	7 - 78
7.11.5 Servo Error Reset (XPM_SRST).....	7 - 79
7.11.6 Servo Error History Reset (XPM_SHRST)	7 - 80
7.11.7 Servo External Input Information Read (XPM_SVIRD).....	7 - 81
7.11.8 Servo Parameter Read (XPM_SVPRD)	7 - 82
7.11.9 Servo Parameter Write (XPM_SVPWR).....	7 - 83
7.11.10 Servo Parameter Save (XPM_SVSAVE)	7 - 84
Chapter 8 Program.....	8-1 ~ 8-145
8.1 Examples of XBC(MK) Program	8 - 1
8.1.1 General Description	8 - 1
8.1.2 Current State Read.....	8 - 1
8.1.3 Operation Ready.....	8 - 5
8.1.4 Operation Test.....	8 - 8
8.1.5 Parameter and Operation Data Setting	8 - 16
8.1.6 Positioning Operation.....	8 - 25
8.1.7 Operation Setting Change while Operating	8 - 48

8.1.8 Error	8 - 70
8.1.9 Program related with the Servo Parameter	8 - 75
8.2 Examples of XEC(IEC) Program	8 - 79
8.2.1 General Description	8 - 79
8.2.2 Current State Read.....	8 - 79
8.2.3 Operation Ready.....	8 - 86
8.2.4 Operation Test.....	8 - 90
8.2.5 Parameter and Operation Data Setting	8 - 95
8.2.6 Positioning Operation.....	8 - 102
8.2.7 Operation Setting Change while Operating	8 - 122
8.2.8 Error	8 - 139
8.2.9 Program related with Servo Parameter	8 - 143
Chapter 9 Function.....	9-1 ~ 9-201
9.1 Home Return	9 - 1
9.2 Positioning Control.....	9 - 6
9.2.1 Operation Data for Positioning Control	9 - 7
9.2.2 Operation Mode of Positioning Control.....	9 - 8
9.2.3 Single-axis Position Control.....	9 - 23
9.2.4 Single-axis Speed Control	9 - 25
9.2.5 Single-axis Feed Control.....	9 - 27
9.2.6 Linear Interpolation Control with 2 axes	9 - 28
9.2.7 Linear Interpolation Control with 3 axes	9 - 40
9.2.8 Linear Interpolation Control with multiple axes	9 - 49
9.2.9 Middle point-specified Circular Interpolation	9 - 51
9.2.10 Center point - specified Circular interpolation.....	9 - 57
9.2.11 Circular interpolation control with designated radius.....	9 - 66
9.2.12 Helical Interpolation Control.....	9 - 74
9.2.13 Ellipse Interpolation Control	9 - 77
9.2.14 Speed/Position Switching Control.....	9 - 81
9.2.15 Speed/Position Switching Control.....	9 - 85
9.2.16 Position/Speed Switching Control.....	9 - 89
9.2.17 Position/Torque Switching Control.....	9 - 91

9.2.18 Start of Positioning	9 - 93
9.2.19 Positioning Stop	9 - 97
9.2.20 Restart	9 - 106
9.2.21 Torque Control	9 - 107
9.2.22 Control by external input signal	9 - 108
9.3 Manual Operation Control.....	9 - 111
9.3.1 JOG Operation	9 - 108
9.3.2 Inching Operation.....	9 - 115
9.3.3 Returning to the previous position of manual operation	9 - 116
9.4 Synchronous Control.....	9 - 118
9.4.1 Speed Synchronous Control	9 - 118
9.4.2 Position synchronous control	9 - 120
9.4.3 CAM Operation	9 - 124
9.4.4 User CAM Operation	9 - 138
9.4.5 Phase correction control	9 - 140
9.4.6 Absolute positioning CAM operation.....	9 - 142
9.4.7 Operation of the synchronous speed designating synchronous position.....	9 - 149
9.5 Modification Function of Control	9 - 151
9.5.1 Floating Origin Setting.....	9 - 144
9.5.2 Continuous Operation.....	9 - 146
9.5.3 Skip Operation.....	9 - 148
9.5.4 Position Override.....	9 - 150
9.5.5 Speed Override	9 - 153
9.5.6 Positioning Speed Override	9 - 155
9.5.7 Current Position Preset	9 - 158
9.5.8 Encoder Preset	9 - 159
9.5.9 Start Step Number Change.....	9 - 160
9.5.10 Repeat Operation Step Number Change.....	9 - 161
9.5.11 Infinite Running Repeat Function.....	9 - 163
9.5.12 Speed Acceleration/Deceleration override.....	9 - 165
9.6 Auxiliary functions of Control	9 - 168
9.6.1 High/Low Limit.....	9 - 168
9.6.2 M Code	9 - 171
9.6.3 External Latch.....	9 - 181

Table of Content

9.6.4 Touch Probe.....	9 - 184
9.7 Data Modification Function	9 - 187
9.7.1 Teaching Array	9 - 187
9.7.2 Parameter Change from Program	9 - 188
9.7.3 Data Change from Program.....	9 - 182
9.7.4 Write/Read Variable Data.....	9 - 184
9.8 User Defined Position / Speed Display Function	9 - 190
9.8.1 Teaching Array	9 - 191
9.8.2 Parameter Change from Program	9 - 197
9.8.3 Data Change from Program.....	9 - 197
9.8.4 Write/Read Variable Data.....	9 - 197

Appendix 1 Positioning Error Information & Solutions.....	A1-1~ A1-20
-----------------------------------------------------------	-------------

Appendix 2 Module Internal Memory Address of "Read/Write Variable Data" command.....	A2-1~ A2-20
--------------------------------------------------------------------------------------	-------------

Appendix 3 Dimension.....	A3-1
---------------------------	------

Appendix 4 Setting Example.....	A4-1 ~ A4-23
---------------------------------	--------------

Appendix 5 Setting Virtual-axis.....	A5-1 ~ A5-3
--------------------------------------	-------------

Warranty and Environmental policy

Chapter 1 Overview

This user's manual describes the standard of positioning module, installation method, the method to use each positioning function, programming and the wiring with external equipment.

1.1 Characteristics

The characteristics of positioning module are as follows.

- (1) The positioning module is available for high performance CPU system of XGB Series(XBC-U, XEC-U).
- (2) Various positioning control function
It has various functions needed for positioning system such as position control, speed control etc.
 - (a) The operation data including positioning address and operation method, operation pattern is available to set up to 400 for each axis.
With this operation data, positioning for each axis is carried out
 - (b) Various single-axis operations are available.
 - 1) Position Control
 - 2) Speed Control
 - 3) Feed Control
 - 4) Multi-axis Simultaneous Start
 - 5) Point Operation
 - (c) Various Multi-axis Operations are available.
 - 1) Circular arc Interpolation (up to 4 groups, 2 axes per one group)
 - 2) Linear Interpolation (up to 8 axes)
 - 3) Helical Interpolation
 - 4) Ellipse Interpolation
 - (d) Switching Control in operation is available.
 - 1) Position/Speed Control Switching
 - 2) Speed/Position Control Switching
 - 3) Position/Torque Control Switching
 - (e) Cam Control is available.
It is available to create up to 8 kinds of cam data with various cam profile of XG-PM.
 - (f) Various Homing Control Function.
 - 1) For Positioning module's Homing, you can use Homing method supported by each servo driver.
 - 2) Available to set the origin of machine without homing by setting the floating origin
 - (g) For the Acceleration/Deceleration method, it is available to select trapezoid or S-type.
- (3) High speed start process
Due to the realization of high speed start process, the start time reduced to 1ms(1~2axis), 2ms(3~5axis), 3ms(6~8axis) . In addition, there is no delay time between axes in Simultaneous start and interpolation start.
- (4) Connection with the servo driver through EtherCAT
 - (a) Able to connect with up to 8 servo driver through EtherCAT
 - (b) Wiring between positioning module and servo driver, between servo drivers is done with Ethernet Cable. So wiring is simple.
 - (c) You can easily check and set up the servo driver information and parameter at the positioning module
 - (d) Max. connection distance is 100m.
- (5) Able to realize the absolute position system
You can realize the absolute position system just by connecting to the servo driver using the absolute position encoder and in case of On/Off, it can know the current position of the motor without homing.

(6) Easy maintenance

Various data such as operation data, operation parameter are saved on MRAM(Magnetic Random Access Memory) in positioning module. Therefore, data will be saved without delay time and there is no limit in writing count.

(7) Self-diagnosis, monitoring and test are available with strong software package, XG-PM.

- (a) Monitoring Function (Module & Servo driver)
- (b) Trace Function
- (c) Trend Function
- (d) Reading and Saving Module Parameter/Operation Data
- (e) Reading and Saving Servo Parameter
- (f) Servo tuning function (L7NH)
- (g) Creation of Cam Data
- (h) Simulation Function
- (i) Providing details about errors and the solution for it
- (j) Print Function of various forms
- (k) Editing operation data in Excel program is available

※ Constraints on the system installation

- (a) Can be installed in environments that provide high-speed expansion I/F
 - Supported CPU : XBC-DxxxU/UA/UP, XEC-DxxxU/UA/UP, XBM-DxxxH2/HP, XEM-DxxxH2/HP
- (b) XBF-PN04B/PN08B is high-speed I/F expansion module, it can be installed on systems with up to two
- (c) Can be installed only at expansion slot 2 or 3
- (d) Not installed behind the general expansion modules
 - When attaching slot 3, slot 2 must be Network position module

1.2 Signal Flow of Positioning Module

The flow of PLC system using the positioning module is as follows.

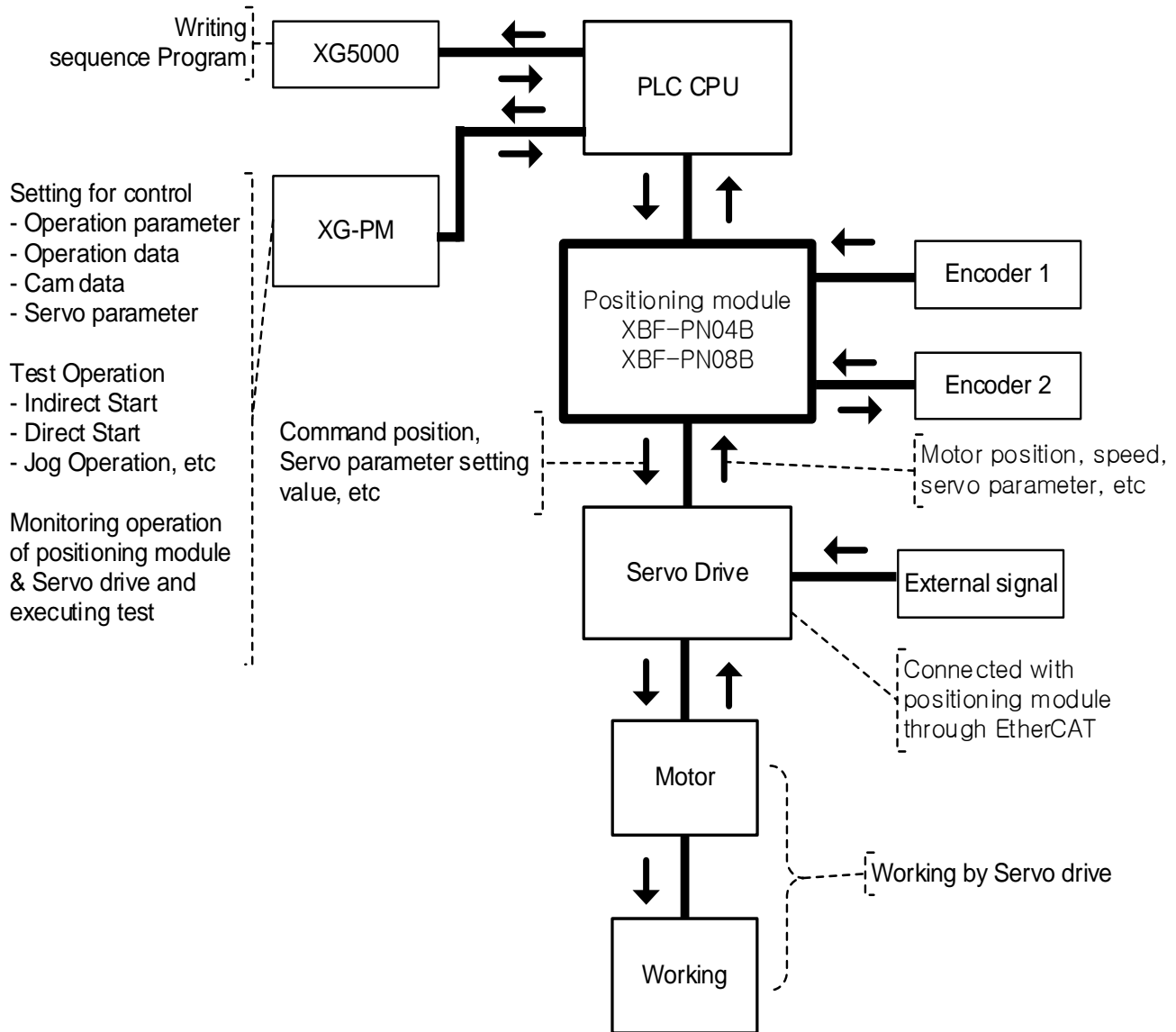

1.3 Function overview of Positioning module

Describe Representative functions of positioning module (Coordinate & Linear Interpolation, Circular Interpolation & Stop) briefly.

1.3.1 Position Control

Execute positioning control for the designated axis from starting position(current position) to goal position(the position to move to).

(1) Control by Absolute coordinates

- Execute positioning control from starting position to goal position designated in positioning data
- Positioning control is executed based on origin designated in homing
- Moving direction is decided by starting position and goal position.
 - Starting Position < Goal Position : Forward Positioning Operation
 - Starting Position > Goal Position : Reverse Positioning Operation

[Example]

- Starting Position : 1000
 - Goal Position : 8000
- Value of Forward movement is 7000 (7000=8000-1000)

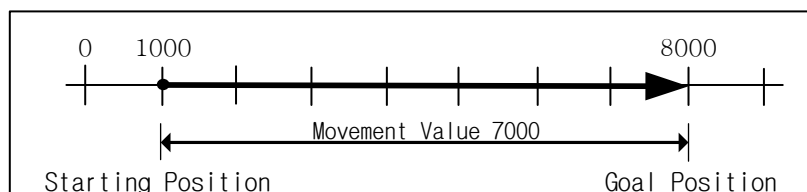

(2) Control by Incremental Coordinates

- Execute positioning control from starting position as much as goal movement value. The difference from absolute coordinates control is that the goal position is movement value, not position value.
- Moving direction depends on sign of movement value.
 - Positive value (+ or Unsigned) : Positioning operation with forward direction
 - Negative value (-) : Positioning operation with reverse direction

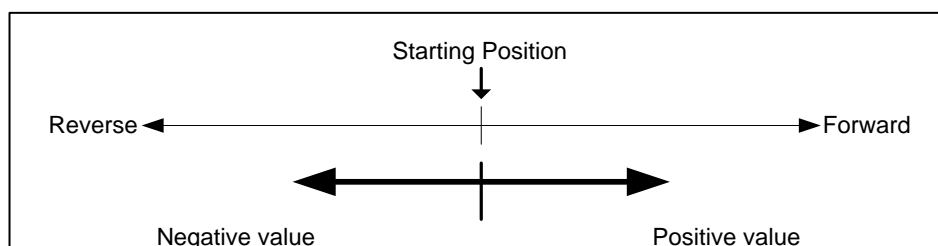

[Example]

- Starting Position : 5000
- Goal Position : -7000

In this condition, it moves reversely and stops at -2000.

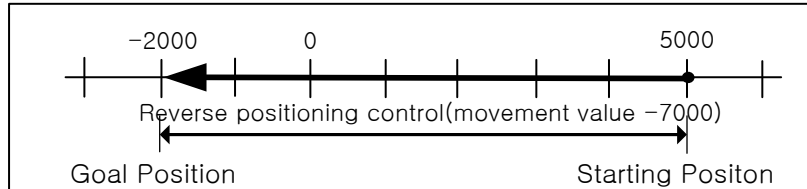

1.3.2 Interpolation Control

(1) Linear Interpolation Control

Execute Linear interpolation control with designated axis at start position (Current position).

Combination of interpolation axis is unlimited and it is available to execute max. 8 axis Linear interpolation control.

(a) Linear interpolation by absolute coordinates

- 1) Execute Linear interpolation from starting position to goal position designated by positioning data.
- 2) Positioning control is executed based on origin designated in homing.
- 3) Movement direction is designated by starting position & goal position of each axis.
 - Starting position < Goal position : Positioning operation with forward direction
 - Starting position > Goal position : Positioning operation with reverse direction

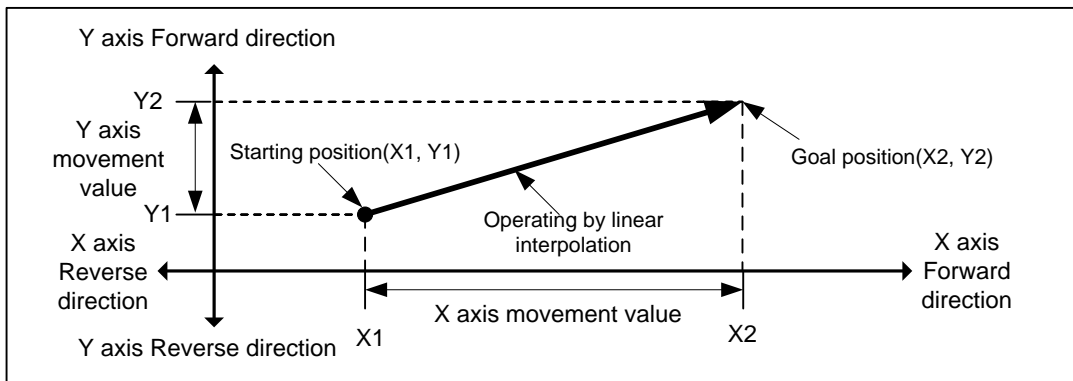

[Example]

- Starting Position (1000, 4000)
- Goal Position (10000, 1000)

In this condition, operation is as follows.

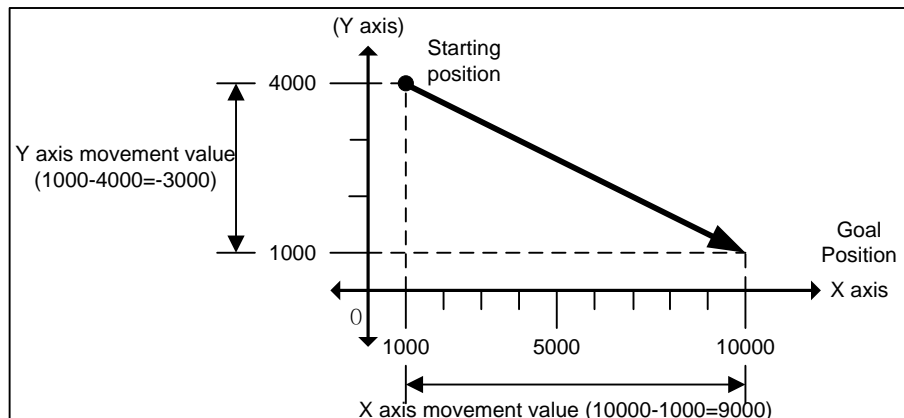

(b) Linear Interpolation by incremental coordinates

- 1) Execute linear interpolation to position including the moving direction and amount of movement with the goal for each axis from starting position.
- 2) Moving direction depends on movement value is positive or negative.
 - Positive value (+ or Unsigned) : Positioning operation with forward direction
 - Negative value (-) : Positioning operation with reverse direction

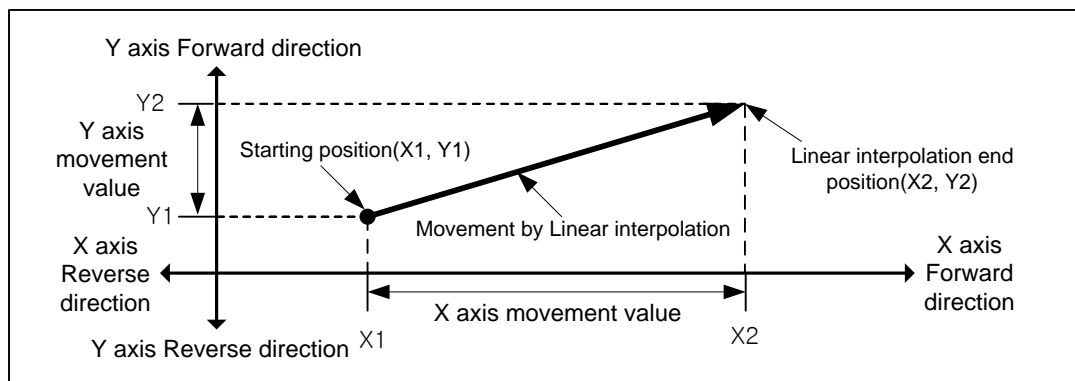

[Example]

- Starting position (1000, 4000)
- Goal position (9000, -3000)

In this condition, operation is as follows.

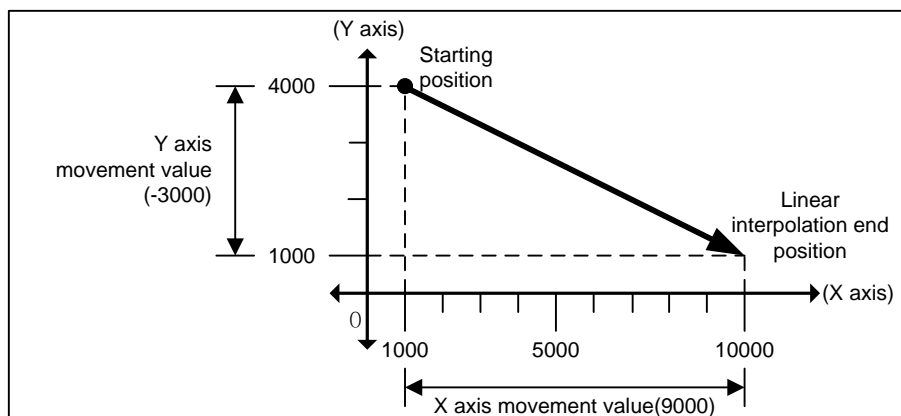

(2) Circular Interpolation Control

Execute interpolation operation along the trace of circle with 2 axes in forward direction that already designated for each axis.

Circular interpolation has 3 types according to auxiliary point, Middle point method passing auxiliary point, Center point method using auxiliary point as center of circle and Radius method using auxiliary point as radius of circle.

In addition, it is available to be executed more than 360° circular interpolation according to the value of “circular interpolation turns”.

The combination of 2 axes that used in circular interpolation is unlimited. (Available to use any 2 of axis1~8)

(a) Middle Point Specified Circular interpolation

- 1) Starts operating at starting position and executes circular interpolation through the designated middle point.
- 2) There will be a circular arc whose center point is crossing point of perpendicular bisection between starting position and middle point or middle point and goal position.

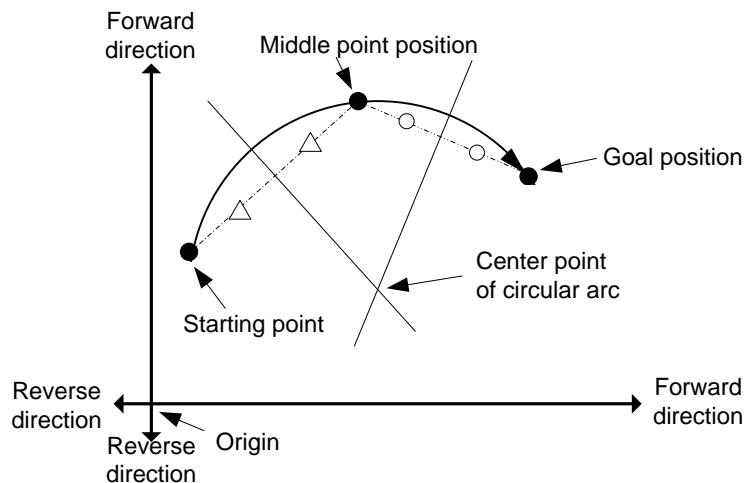

- 3) Control unit “degree” is not available to be used for circular interpolation control.
- 4) Movement direction is automatically designated by goal position and auxiliary point of circular interpolation.

(b) Center Point Specified Circular interpolation

- 1) Starts operating from starting position and execute circular interpolation along trace of circle that has distance from starting point to designated center point as radius.

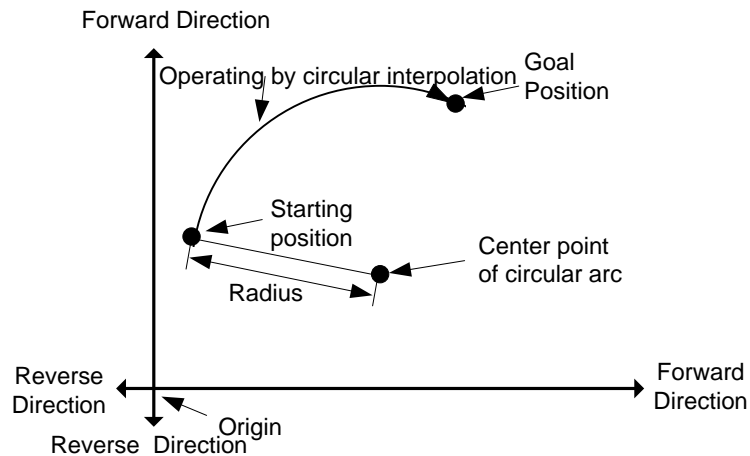

- 2) If the goal position is same as starting position, it is available to have an operation like a circle that has distance from starting point to auxiliary point as its radius.

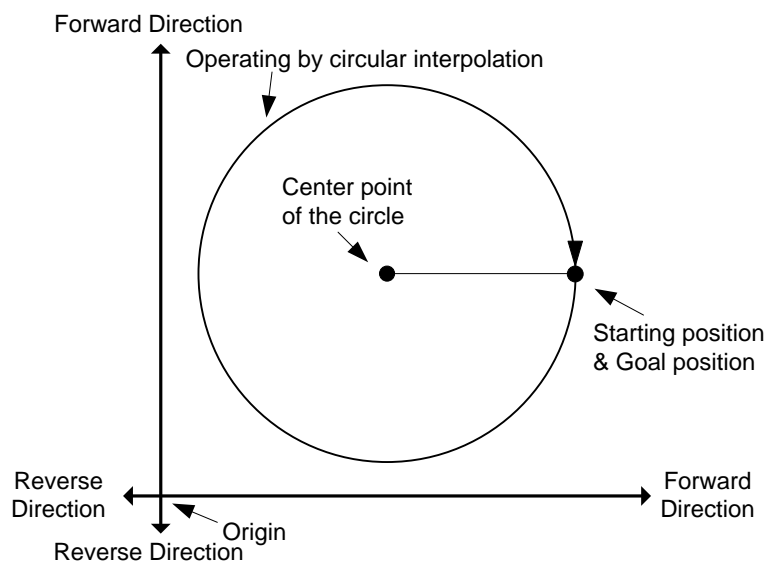

- 3) Control unit "degree" is not available to be used for circular interpolation control.
- 4) Direction is determined in setting of "Cir int. mode" (Center point CW, Center point CCW).

(c) Radius Specified Circular interpolation

- 1) Starts operating from starting position and execute circular interpolation along trace of circular arc that has value designated in auxiliary point of main axis as its radius. Depending on size setting of circular arc ($<180^\circ, \geq 180^\circ$), center point of circular arc will be different.

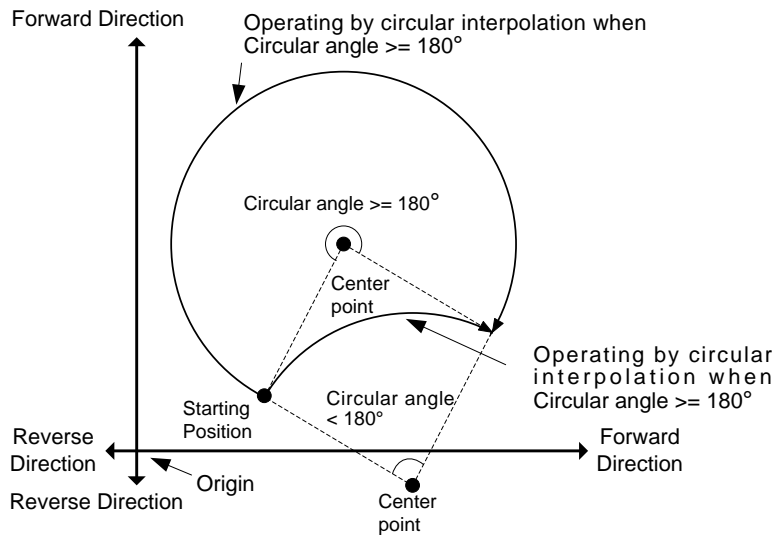

- 2) In radius designation form, goal position can not be set the same as starting position.
- 3) Control unit "degree" is not available to be used for circular interpolation control.
- 4) The direction and arc size are determined in "Cir. int. mode".

(3) Helical Interpolation

- (1) Moves along the designated trace of circular arc depending on circular arc interpolation setting and executes Linear interpolation synchronously.
- (2) It is available to execute helical interpolation of more than 360° depending on 'Circular interpolation turns' setting.
- (3) The combination of axis that used for helical interpolation control is unlimited, 3 axes among axis1 ~ 8 are used.

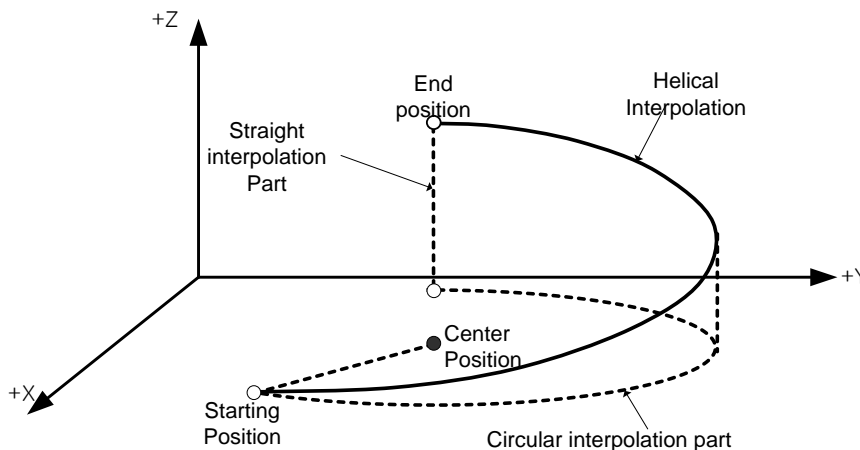

1.3.3 Speed Control

- (1) It is executed by positioning operation start command (Direct start, Indirect start, Synchronous start) and keeps operating with designated speed until Dec. stop command.
- (2) Speed control has forward operation and reverse operation.
 - (a) Forward operation : Position value ≥ 0
 - (b) Reverse operation : Position value < 0
- (3) In case of speed control, M code will be on only when M code mode is "With".
- (4) Operating Timing

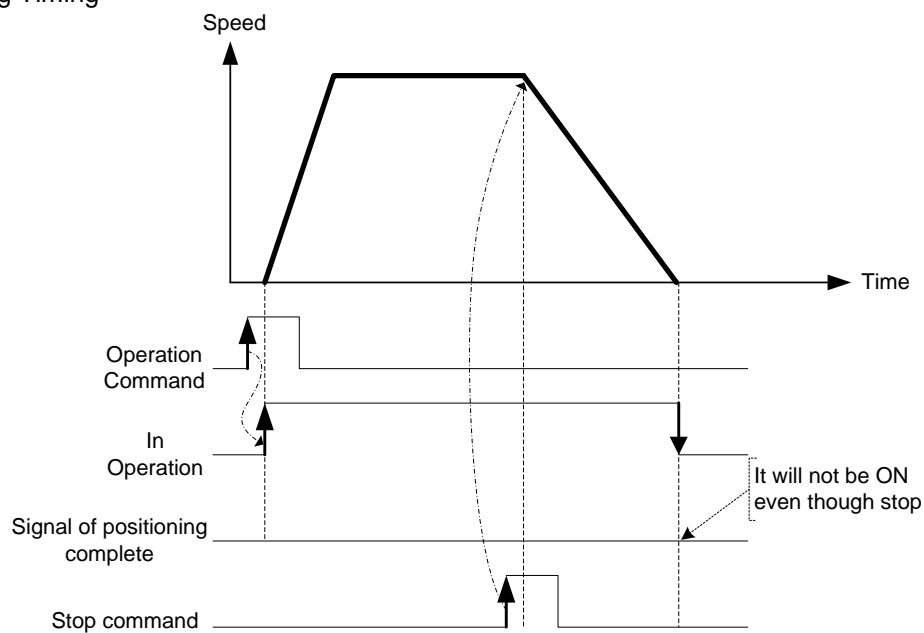

1.3.4 FEED Control

- (1) After executed by positioning start, resets the current position as 0 and starts positioning as much as movement value already set.
- (2) Movement direction is decided by movement value.
- (3) Feed control has forward direction operation and reverse direction operation.
 - (a) Forward direction : Position value ≥ 0
 - (b) Reverse direction : Position value < 0
- (4) Operation timing is as follows.

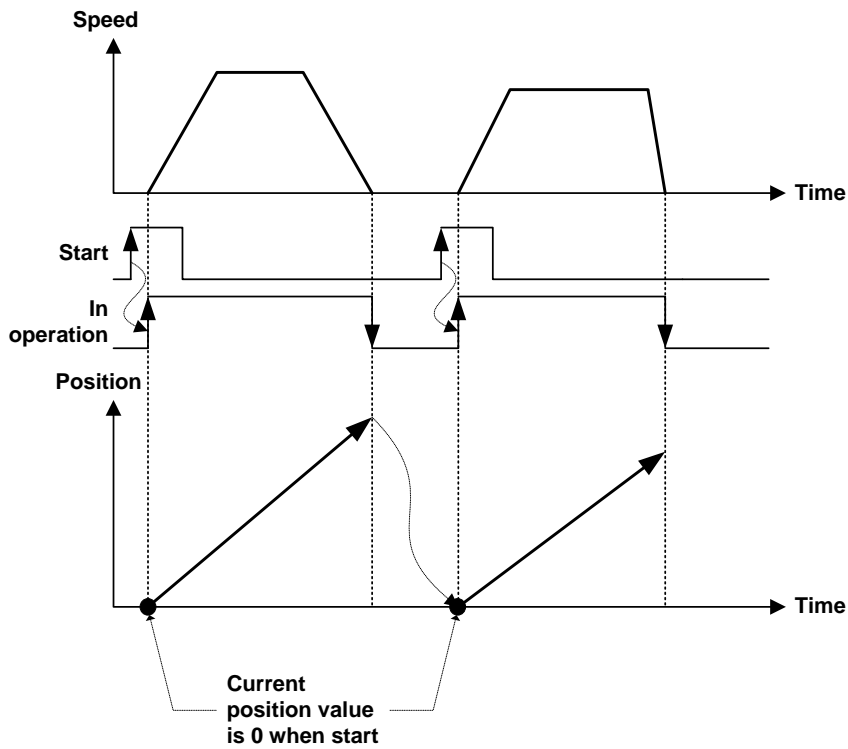

Chapter 2 Specification

2.1 General Specifications

The following table shows the general specification of XGT series.

No.	Item	Specifications	Related specifications					
1	Ambient temperature	0 °C ~ +55 °C	-					
2	Storage temperature	-25 °C ~ +70 °C	-					
3	Ambient humidity	5 ~ 95%RH (Non-condensing)	-					
4	Storage humidity	5 ~ 95%RH (Non-condensing)	-					
5	Vibration resistance	Occasional vibration		-	10 times each directions (X, Y and Z)	IEC61131-2		
		Frequency	Acceleration	Amplitude			How many times	
		5 ≤ f < 8.4 Hz	-	3.5 mm				
		8.4 ≤ f ≤ 150 Hz	9.8 m/s ² (1G)	-				
		For continuous vibration						
		Frequency	Acceleration	Amplitude				
		5 ≤ f < 8.4 Hz	-	1.75 mm				
8.4 ≤ f ≤ 150 Hz	4.9 m/s ² (0.5G)	-						
6	Shock resistance	<ul style="list-style-type: none"> Peak acceleration: 147 m/s²(15G) Duration: 11ms Half-sine, 3 times each direction per each axis 	IEC61131-2					
7	Noise resistance	Square wave Impulse noise	AC: ± 1,500V DC: ± 900V	LS Electric Standard				
		Electrostatic discharge	Voltage : 4kV (contact discharging)	IEC 61131-2, IEC 61000-4-2				
		Radiated electromagnetic field noise	80 ~ 1,000 MHz, 10V/m	IEC 61131-2, IEC 61000-4-3				
		Fast transient /bust noise	<table border="1"> <tr> <td>Segment</td> <td>Power supply module</td> <td>Digital/analog input/output communication interface</td> </tr> <tr> <td>Voltage</td> <td>2kV</td> <td>1kV</td> </tr> </table>	Segment	Power supply module	Digital/analog input/output communication interface	Voltage	2kV
Segment	Power supply module	Digital/analog input/output communication interface						
Voltage	2kV	1kV						
8	Environment	Free from corrosive gasses and excessive dust	-					
9	Altitude	Up to 2,000 ms	-					
10	Pollution degree	Less than equal to 2	-					
11	Cooling	Air-cooling	-					

Remark

(1) IEC (International Electrotechnical Commission):

An international nongovernmental organization which promotes internationally cooperated standardization in electric/electronic field, publishes international standards and manages applicable estimation system related with.

(2) Pollution degree:

An index indicating pollution degree of the operating environment which decides insulation performance of the devices. For instance, Pollution degree 2 indicates the state generally that only non-conductive pollution occurs. However, this state contains temporary conduction due to dew produced.

2.2 Performance Specifications

The following table shows the performance specifications of XGT Positioning Module.

2.2.1 Function Specifications

Items		Specification			
No. of control axis		4,8			
Interpolation function		2~4(8) axes linear interpolation, 2 axes circular interpolation, 3 axes helical interpolation			
Control method		Position control, Speed control, Speed/Position control, Position/Speed control, Position/Torque Control, Feed control			
Control unit		Pulse, mm, inch, degree			
Positioning data		Each axis can have up to 400 operation data .(Operation step number : 1 ~ 400) Available to set with XG-PM or program			
XG-PM	Connection	RS-232C port of CPU module or USB			
	Setting data	Common, Basic, Extended, Servo parameter, Operation data, Cam data, Command information			
	Monitor	Operation information, Trace, Input terminal information, Error information			
Back-up		Save the parameter, operation data in MRAM ROM (No need of Battery)			
POSITIONING	Positioning method	Absolute method/Incremental method			
	Position address range		Absolute	Incremental	Speed/Position, Position/Speed Switching control
		mm	-214748364.8 ~ 214748364.7(μ m)	-214748364.8 ~ 214748364.7(μ m)	-214748364.8 ~ 214748364.7(μ m)
		Inch	-21474.83648 ~ 21474.83647	-21474.83648 ~ 21474.83647	-21474.83648 ~ 21474.83647
		degree	-21474.83648 ~ 21474.83647	-21474.83648 ~ 21474.83647	-21474.83648 ~ 21474.83647
		pulse	-2147483648 ~ 2147483647	-2147483648 ~ 2147483647	-2147483648 ~ 2147483647
Speed range	mm	0.01 ~ 20000000.00(mm/min)			
	Inch	0.001 ~ 2000000.000(Inch/min)			
	degree	0.001 ~ 2000000.000(degree/min)			
	pulse	1 ~ 20,000,000(pulse/SEC)			
	rpm	0.1 ~ 100000.0(RPM)			
Acc./Dec. process	Trapezoid type, S-type				
Acc./Dec. time	1 ~ 2,147,483,647 ms selection is available from 4 types of acceleration/deceleration pattern				
Manual Operation	Jog Operation, MPG Operation, Inching Operation				
Homing method	Refer to the method supported by the servo driver				
Speed change function	Speed change (Percent/Absolute value)				
Torque unit	Rated torque % designation				
Absolute position system	Available (when using absolute encoder type servo driver)				

Items		Specification
External Encoder input	Channel	1 channel
	Max. Input	200 kpps
	Input form	Line drive input (RS-422A IEC specification), open collector output type encoder
	Input type	CW/CCW, PULSE/DIR, Phase A/B
	Connection connector	9-point connector
External command signal	Input point	3Point(Input signal A,B,Z)
	Input specification	Same as Input specification of external encoder(5V,24V)
	Connector	9Point connector(input terminal of external encoder shared)
Communication Period		1ms
Max. transmission distance		100m
Communication cable		Over CAT.5 STP (Shielded Twisted-pair) cable
Error indication		Indicated by LED
Communication status indication		Indicated by LED
Consumable current		510mA
Weight		115g

2.2.2 Encoder Input Specification

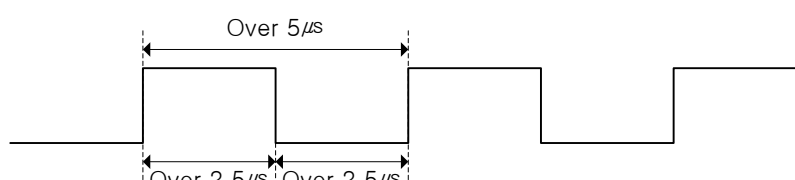
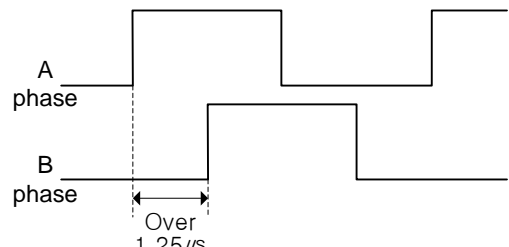
Item	Specification	
	Open Collector	Line Drive
Input voltage	DC5V (4.5V ~ 5.5V)	DC24V (19.2V ~ 26.4V)
Input current	8 mA ~ 11 mA	8mA ~ 11mA
Min. On guarantee voltage	4.1V	17.0V
Max. Off guarantee voltage	1.7V	4.5V
	In accordance with RS-422A Line Driver Level(5V Level)	
Input pulse	1) Pulse width 	
	2) Phase difference  <p>When A phase input pulse is ahead of B phase input pulse : Position value increases</p> <p>When B phase input pulse is ahead of A phase input pulse : Position value decreases</p>	

2.2.3 Input specification of external command signal

External command signal, for use in common to the encoder input terminal, input standard is the same as the encoder input specifications.

Items	Specification	
Input voltage	DC5V (4.5V ~ 5.5V)	DC24V (19.2V ~ 26.4V)
Input current	8mA ~ 11mA	8mA ~ 11mA
Min. On guarantee voltage	4.1V	17.0V
Max. Off guarantee voltage	1.7V	4.5V

Remark

The positioning module's operation recognizing external command signal is processed by software. Therefore, after the external command signal is On, it is recognized as On signal to be maintained voltage level for at least one control period.

Control period in accordance with the axis number, are as follows.

- 1~2axis: 1ms, 3~4axis: 2ms

2.3 The Name of Each Part

2.3.1 The name of each part

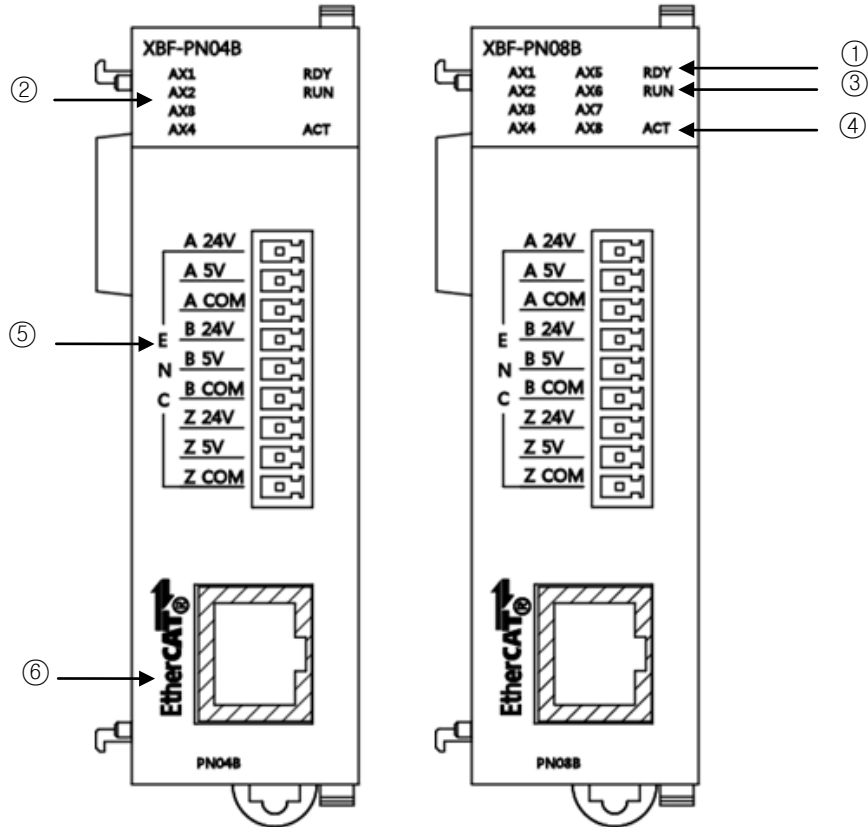

No.	Name	Description
①	Module ready signal (RDY)	On: Positioning module normal status Off: Power OFF or CPU module reset status Flicker: Positioning module abnormal status
②	Operation indicator LED	On: applicable axis is running Off: applicable axis is stop status Flicker: applicable axis is error status
③	Communication status indicator LED (RUN)	On: communication with servo driver is connected Off: communication with servo driver is disconnected Flicker: Error occurs during communicating with servo driver
④	TRX status LED (ACT)	On: Wiring with servo driver is done Off: Wiring with servo driver is not done Flicker: communicating with servo driver
⑤	Connector for encoder wiring	Connector to connect with encoder (Share encoder connector when using a function of the external command signal)
⑥	RJ-45 connector	RJ-45 connector to connect with servo driver

2.3.2 Specification of interface with external device

(1) Pin arrangement of connector

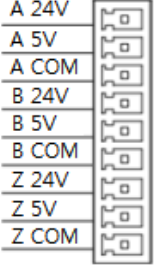
Pin arrangement	Pin No.	Signal name		Signal direction
	1	A 24V	Encoder A 24V input	input
	2	A 5V	Encoder A 5V input	
	3	A COM	Encoder A input COM	
	4	B 24V	Encoder B 24V input	
	5	B 5V	Encoder B 5V input	
	6	B COM	Encoder B input COM	
	7	Z 24V	Encoder Z 24V input	
	8	Z 5V	Encoder Z 5V input	
	9	Z COM	Encoder Z input COM	

※If you want to use as a function of the external command signal, Encoder A,B,Z is used as the input signal A,B,Z.

(2) Internal circuit

Item	Pin No.	Signal	
<p>*Remark1</p>	1	A 24V	Encoder A 24V input
	2	A 5V	Encoder A 5V input
	3	A COM	Encoder A input COM
	4	B 24V	Encoder B 24V input
	5	B 5V	Encoder B 5V input
	6	B COM	Encoder B input COM
	7	Z 24V	Encoder Z 24V input
	8	Z 5V	Encoder Z 5V input
	9	Z COM	Encoder Z input COM
<p>*Remark2</p>	1	A 24V	Encoder A 24V input
	2	A 5V	Encoder A 5V input
	3	A COM	Encoder A input COM
	4	B 24V	Encoder B 24V input
	5	B 5V	Encoder B 5V input
	6	B COM	Encoder B input COM
	7	Z 24V	Encoder Z 24V input
	8	Z 5V	Encoder Z 5V input
	9	Z COM	Encoder Z input COM

Remark

*** Remark 1**

Wiring of encoder is example about 5V voltage output type (open collector).

When using 24V type MPG, change the input voltage from 5V to 24V and connect the power source to 24V input terminal(A 24V, B 24V, Z 24V),which Pin numbers are Pin 1, 4, 7.

(adding PULL-UP resistor is not needed)

When using 12V type MPG, change the input voltage from 5V to 12V and connect the power source to 5V input terminal(A 5V, B 5V, Z 5V),which Pin numbers are Pin 2, 5, 8. Adding 1kΩ PULL-UP resistor between power source and input terminal is needed

When using 5V type MPG, input voltage is 5V and connect the power source to 24V input terminal(A 5V, B 5V, Z 5V) ,which Pin numbers are Pin 2 5, 8.

(adding PULL-UP resistor is not needed)

*** Remark 2**

Wiring of encoder 2 is example about 5V voltage output type (line driver)

This describes the internal circuit of the module when connecting the encoder.

Item	Internal circuit	No.	Terminal	Pin number	Signal name
				Encoder1	
Input		①	A 24V	1	Encoder A 24V input
		②	A 5V	2	Encoder A 5V input
		③	A COM	3	Encoder A input COM
		①	B 24V	4	Encoder B 24V input
		②	B 5V	5	Encoder B 5V input
		③	B COM	6	Encoder B input COM
		①	Z 24V	7	Encoder Z 24V input
		②	Z 5V	8	Encoder Z 5V input
		③	Z COM	9	Encoder Z input COM

Chapter 3 Operation Order and Installation

3.1 Operation Order

► Here describes the Operation order in case of positioning operation by positioning module.

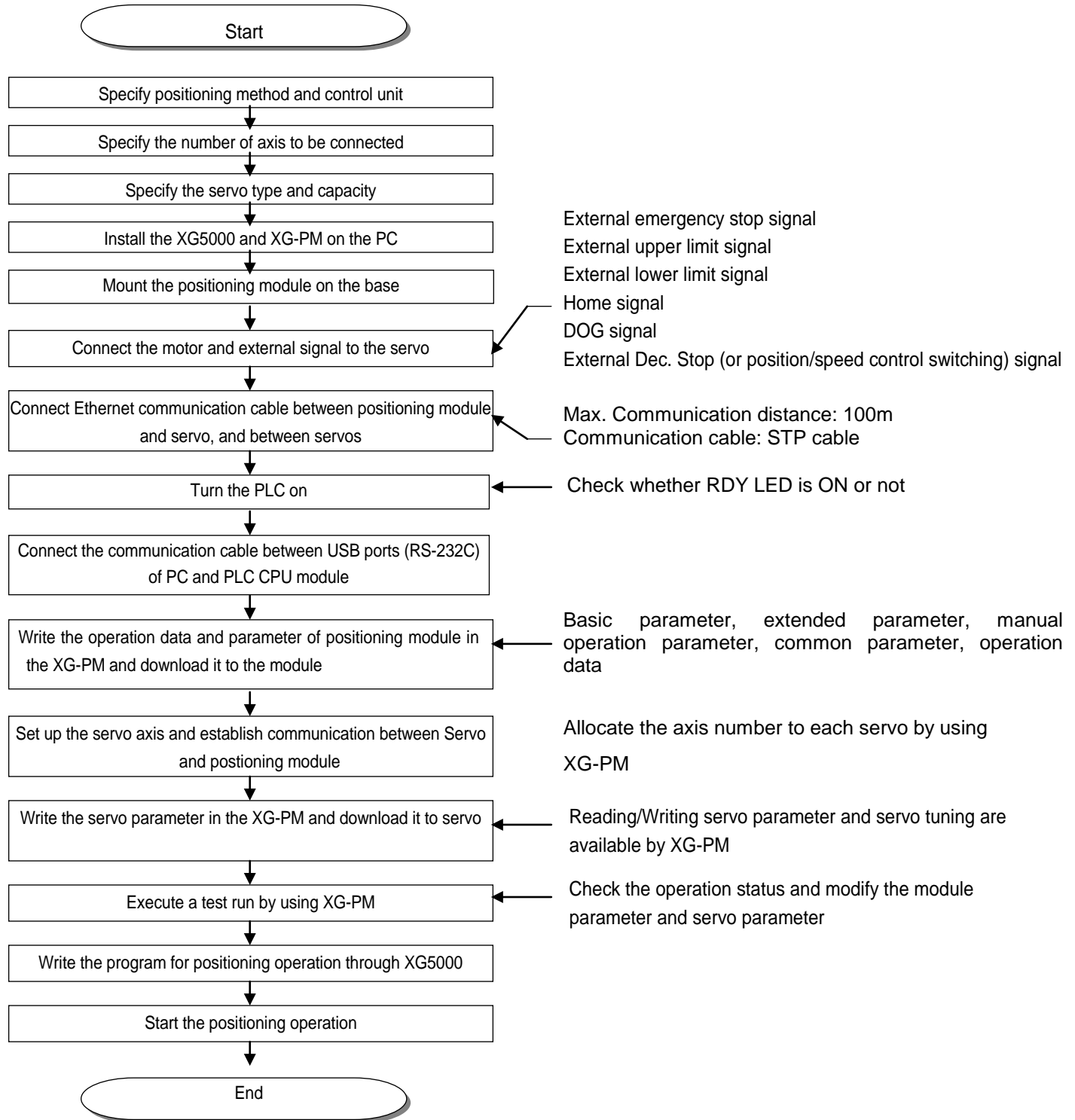

3.2 Installation

3.2.1 Installation Environment

This machine has a good reliability regardless of installation environment but cares should be taken in the following items to guarantee the reliability and safety of the system.

(1) Environment Condition

- Install the control panel available for water-proof, anti-vibration.
- The place free from continuous impact or vibration.
- The place not exposed to direct rays.
- The place with no dew phenomena by rapid temperature change.
- The place where surrounding temperature maintains 0-55°C.

(2) Installation Construction

- In case of processing the screw hole or wiring, cares should be taken not to put the wiring remnants to PLC inside.
- Install on the good place to operate.
- Do not install the high voltage machine on the same Panel.
- The distance from duct or surrounding module shall be more than 50mm.
- Ground to the place where surrounding noise environment is good enough.

3.2.2 Notices in Handling

Here describes the notices in handling the positioning module from opening to installation.

- (1) Do not fall down or apply the strong impact.
- (2) Do not remove PCB from the case. It may cause the failure.
- (3) In wiring, cares should be taken not to put the wiring remnants or foreign materials to the upper part of module. If something entered, it should be removed.
- (4) The removal of module in the status of power ON is prohibited.

3.3 Notices in Wiring

3.3.1 Notices in Wiring

- (1)The length of connecting cable between positioning module and drive machine shall be as short as possible. (Max. length: 2m and 10m).
- (2)For alternating current and external I/O signal of positioning module, it is required to use the separate cables to avoid the surge or induction noise generated from the alternating current.
- (3)The wires should be selected considering surrounding temperature, allowable current and it is recommended to be more than max. size AWG22(0.3mm²).
- (4)In wiring, if it is too close to the high temperature machine or material or it is directly contacted to the oil for a long time, the short-circuit will occur that may cause the damage or malfunction.
- (5)Make sure to check the polarity before applying the external contact signal to the terminal board.
- (6)In case of wiring the high voltage cable and power cables together, the induction noise occurs that may cause the malfunction or failure.
- (7)In case of wiring by the pipe, the grounding of pipe is required.
- (8)For the communication cable between the positioning module and the driver, user STP CAT-5 or above for connection .
- (9)When the communication error occurs during operation of positioning module, which may be caused by noise interference in wiring between the positioning module and the driver. At this time, attach Ferrite Core to the communication cable to prevent the noise.
- (10)The communication cable of positioning module and input cable of encoder flow high-speed electrical signal. Therefore, the noise radio waves of high frequency from this cable has been radiated. In order to ensure the CE standards suitability, please attach a ferrite to communication cable and encoder input cable.

3.3.2 Connection Example of Servo and Stepping Motor Drive Machine

(1) This is wiring example connecting XGT servo drive/motor to positioning module(XBF-PN04B/PN08B). For more information about the installation and wiring, please refer to the relevant drive's instructions.

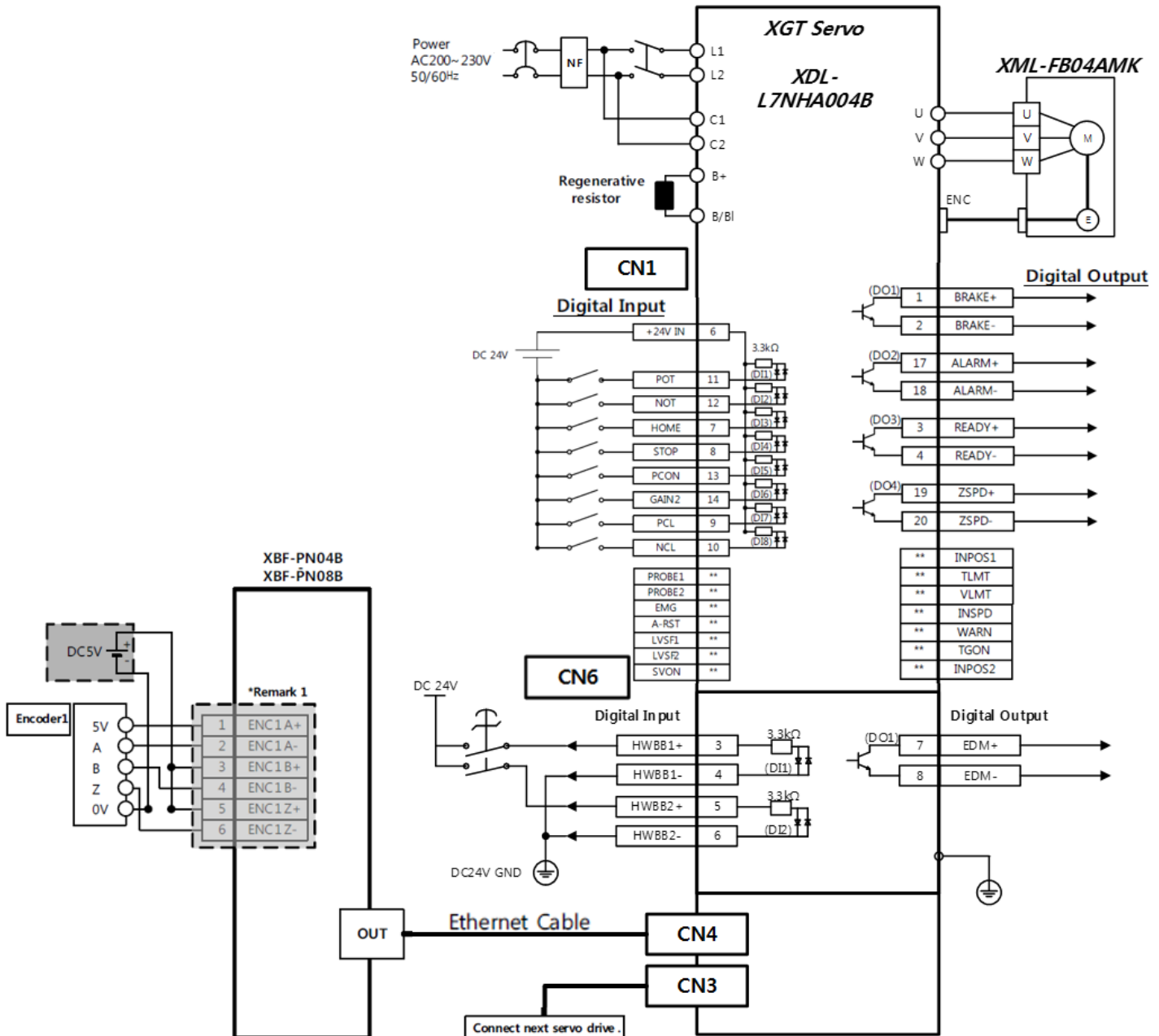

(2) This is wiring example connecting XGT servo drive/motor to positioning module(XBF-PN04B/PN08B). For more information about the installation and wiring, please refer to the relevant drive's instructions.

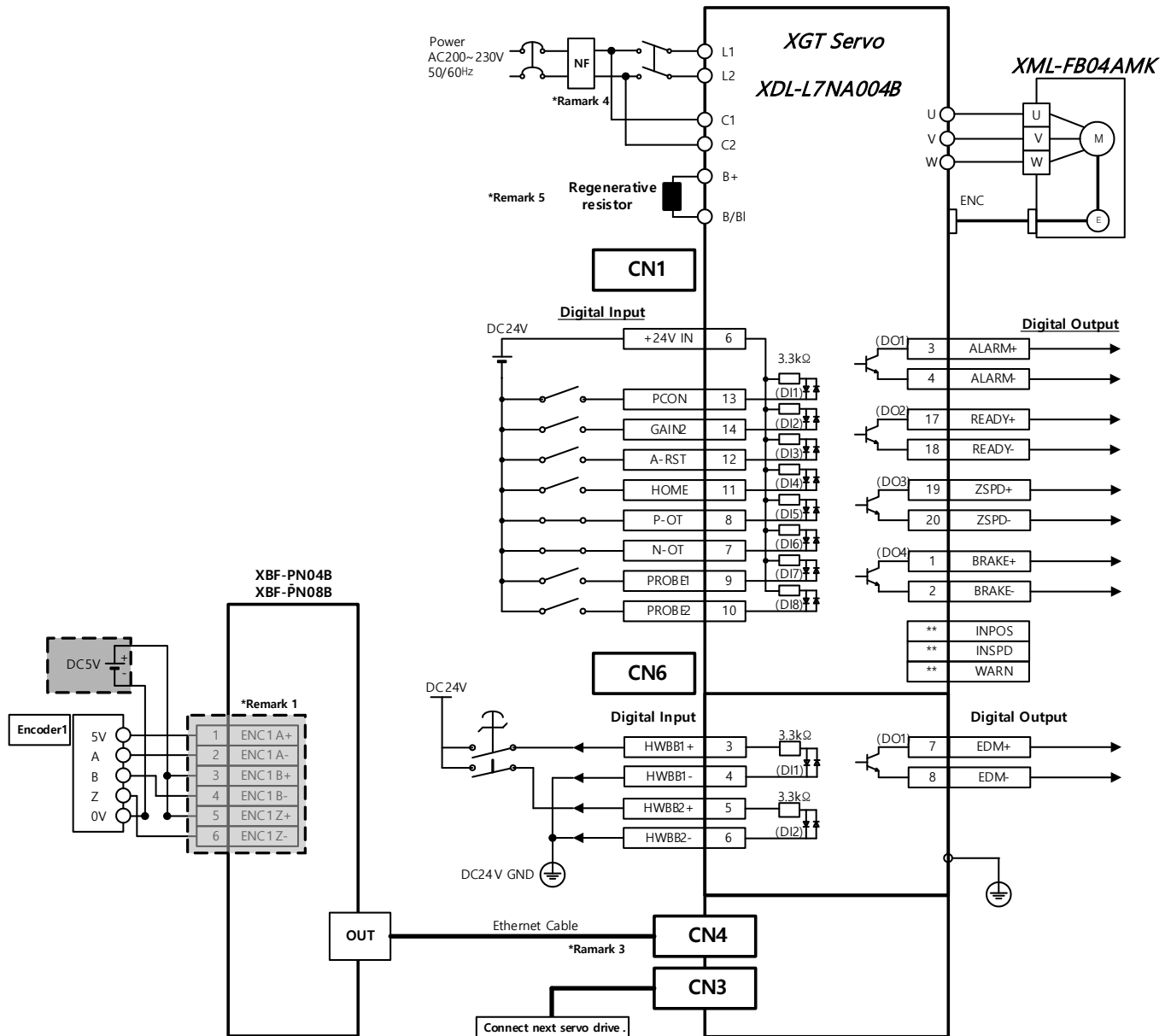

Remark

* Remark 1

Input signal DI1~DI8, output signal DO1~DO4 is the initial signal assigned at the factor shipments

* Remark 2

It is unassigned signal. You can change the contact on the setting of the allocation of the output signal. For more information, please refer to the user's manual of the XGT servo drive.

* Remark 3

Input signal DI7, DI8 is assigned regardless of the setting of the assignment of the input signal, and work PROBE1, PROBE2 input signal.

* Remark 4

Wiring of encoder is an example about 5V voltage output (open collector) type.

* Remark 5

When connecting more than 2 servo drivers, connect first servo driver's IN to the positioning module's OUT and for other servo drivers, connect previous servo driver's OUT to next servo driver's IN. last servo driver's OUT doesn't need to be connected. And connection order is not related with axis order.

* Remark 6

Please use the NF(Noise Filter) always to prevent noise from coming in.

3.3.3 Encoder Input (DC 5V Voltage Output) Wiring Example

When Pulse Generator is a Voltage Output type, wiring example of positioning module and Encoder input part is as follows.

In case pulse generator is totem-pole output and used as voltage output style, wiring is equal.

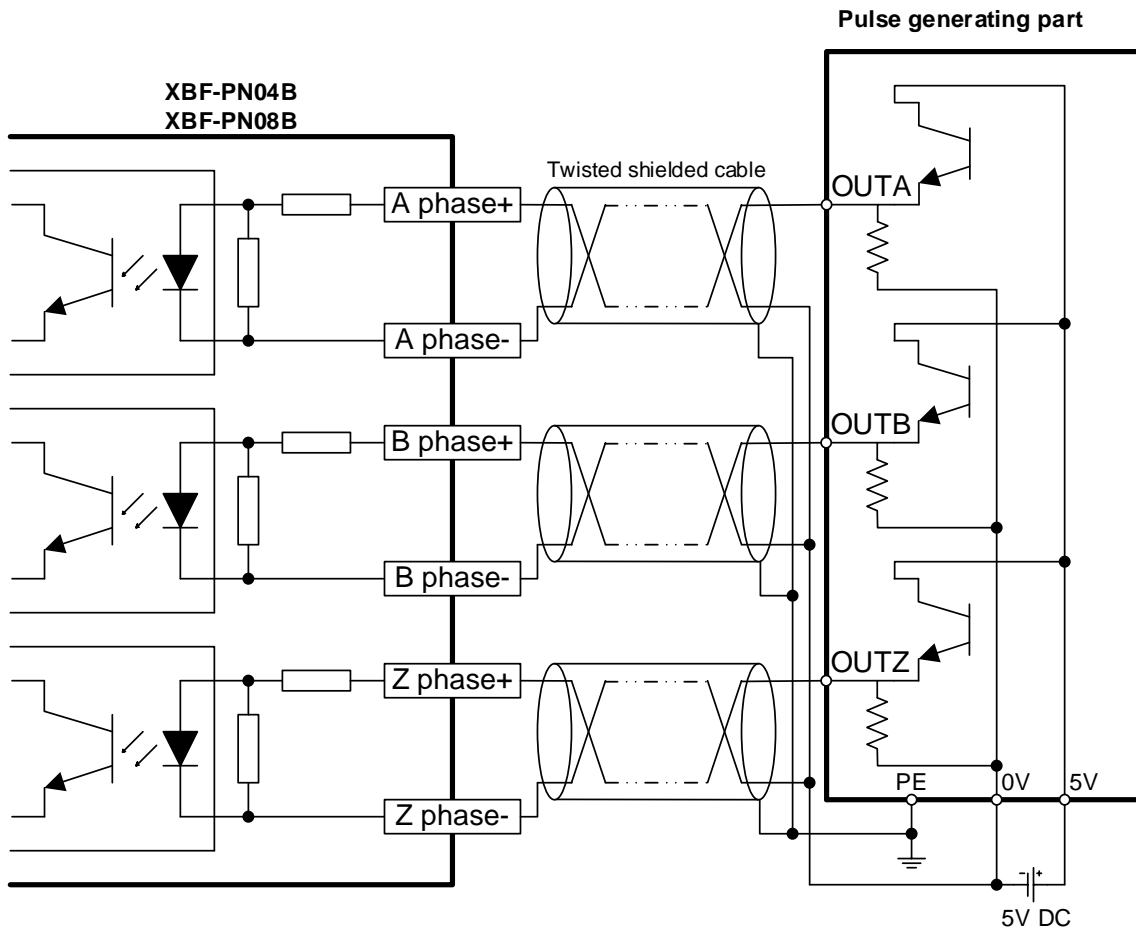

Remark

Before Wiring, please consider maximum output distance of pulse generator.

3.3.4 Encoder Input (DC 24V NPN Open Collector Output) Wiring Example

This is wiring example connecting NPN of pulse generation(encoder or a hand-operated pulse generation) of open collector output type.

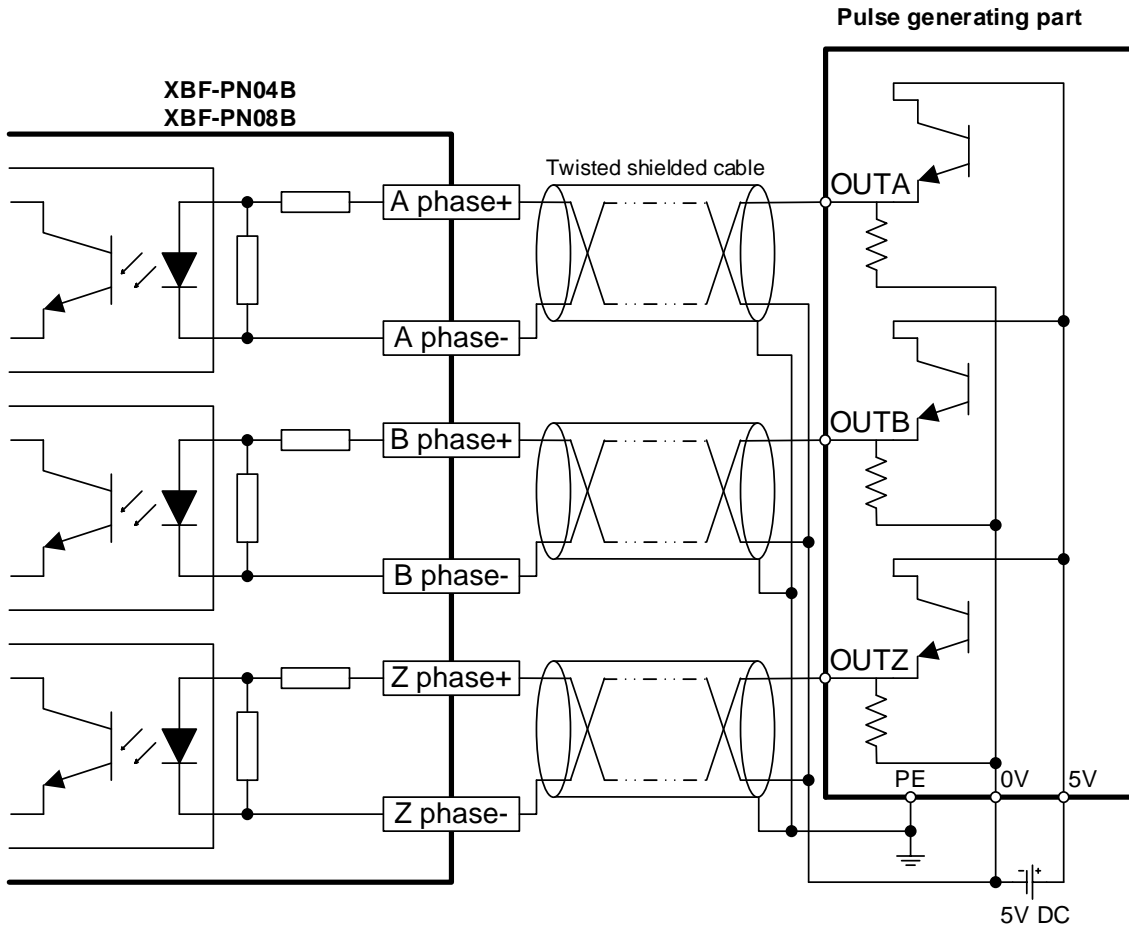

Remark

Before Wiring, please consider maximum output distance of pulse generator.

Remark

Please install pull-up resistance when wiring to pulse generation(encoder or a hand operated pulse generation) and encoder input in order to prevent malfunctions due to noise in environments with external line noise.
 (Please use external pull-up resistance in accordance with the standards of the external load equipment.)

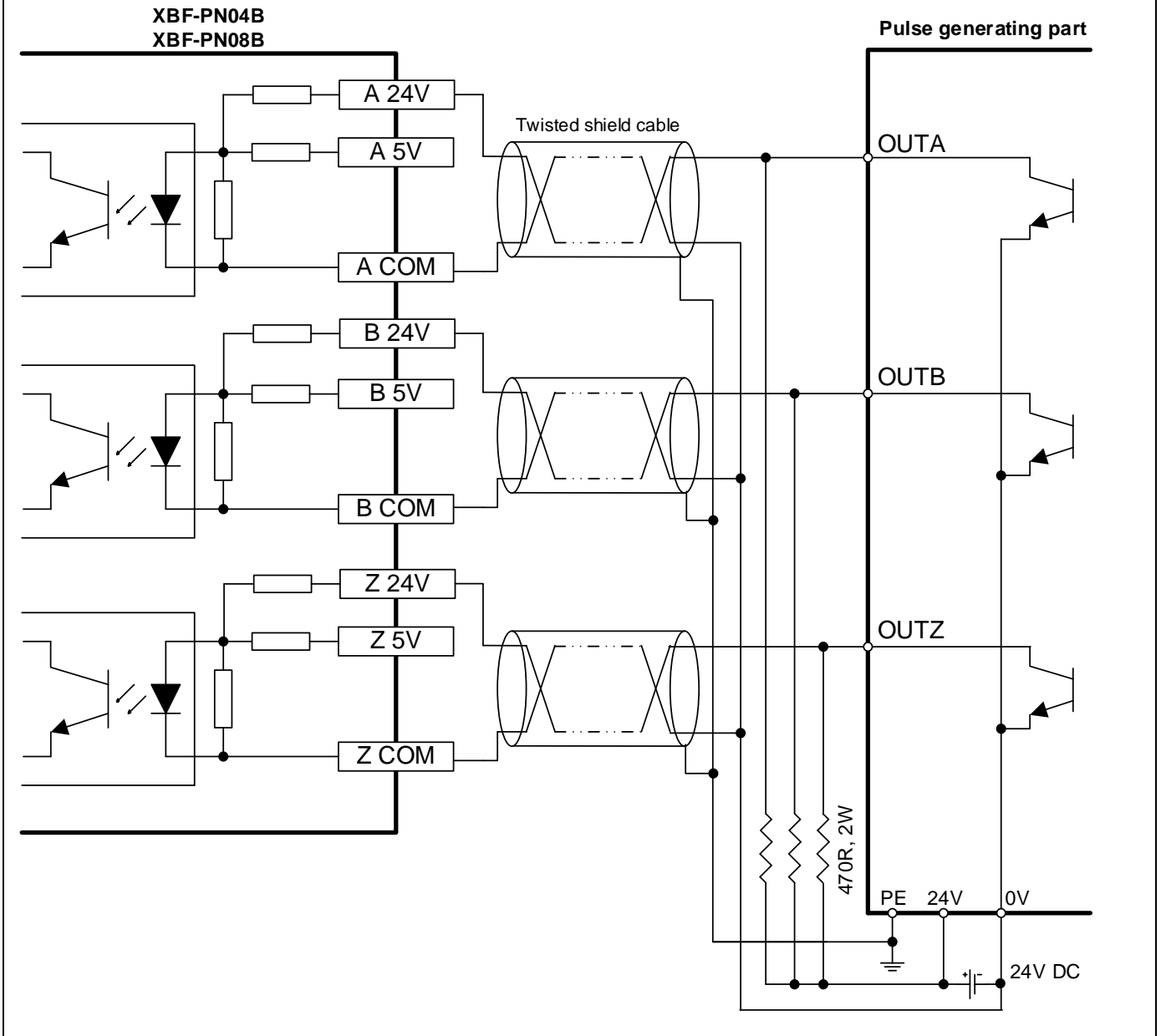

3.3.5 Encoder Input (5V Line Driver Output) Wiring Example

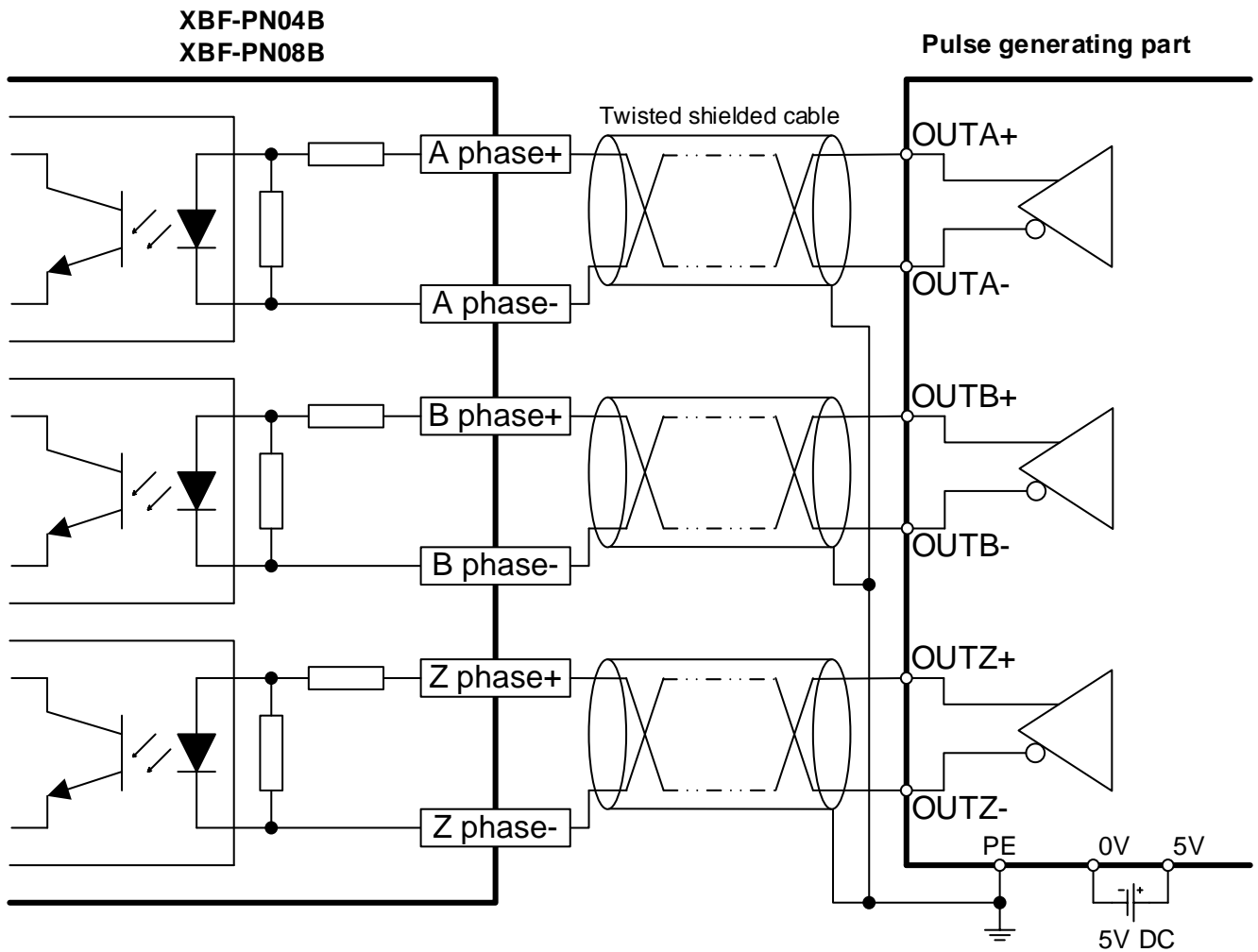

Remark

Before Wiring, please consider maximum output distance of pulse generator.

Chapter 4 Positioning Parameter & Operation Data

This chapter describes parameter and operation data about positioning module.

4.1 Parameter & Operation data

This picture describes process of parameter and operation data saved in the module.

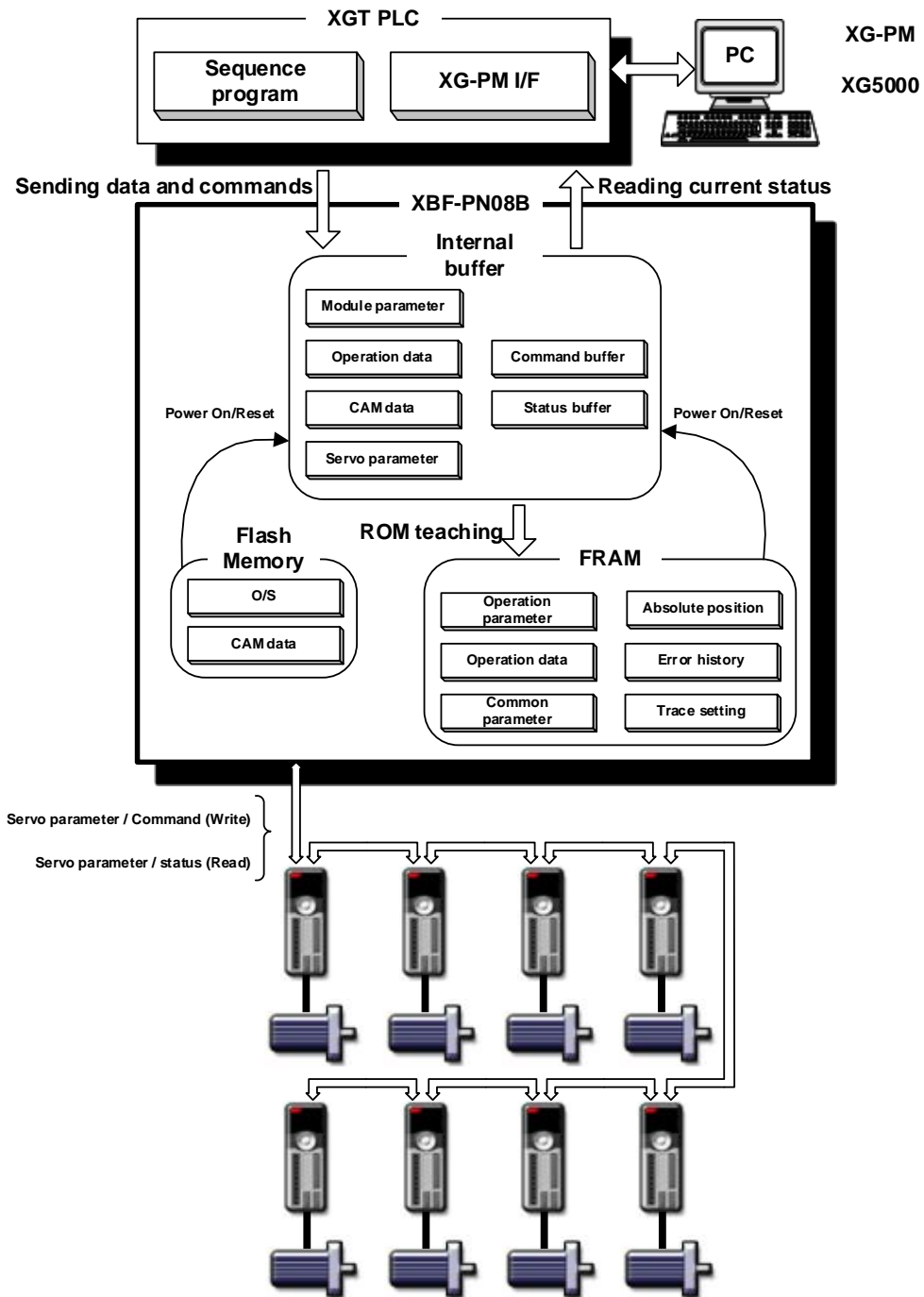

4.2 Basic Parameter

Here describes about basic parameter of positioning module.

4.2.1 Basic parameter

Basic parameter item		Setting range
Speed limit		mm : 1 ~ 2,147,483,647 [$\times 10^{-2}$ mm/min] Inch : 1 ~ 2,147,483,647 [$\times 10^{-3}$ Inch/min] degree : 1 ~ 2,147,483,647 [$\times 10^{-3}$ degree/min] pulse : 1 ~ 2,147,483,647 [pulse/sec]
Acceleration time 1		1 ~ 2,147,483,647 [ms]
Acceleration time 2		
Acceleration time 3		
Acceleration time 4		
Deceleration time 1		1 ~ 2,147,483,647 [ms]
Deceleration time 2		
Deceleration time 3		
Deceleration time 4		
Deceleration time for EMG stop		1 ~ 2,147,483,647 [ms]
Pulse per rotation		1 ~ 200,000,000
Travel per rotation		
Control word	Axis Type(bit 0)	0:Real axis, 1:Virtual axis
	unit (bit 2 ~ 3)	0:Pulse, 1:mm, 2:Inch, 3:Degree
	Unit multiplier (bit 4 ~ 5)	0: x 1, 1: x 10, 2: x 100, 3: x 1000
	Speed command unit (bit 6)	0: unit/time, 1: rpm
	Encoder select (bit 7)	0:Incremental Encoder, 1:Absolute Encoder
	Current position display correction(bit 8 ~ 15)	0 ~ 255

Remark

1. For Deceleration time in case of stop, when it stops by DEC. stop, DEC. time set in command is applied. At this time, if DEC. time is set as 0 in command, DEC. time set in basic parameter is applied. In case it stops by EMG stop because of internal factor, not external factor, EMG stop deceleration time in basic parameter is applied.
2. OS version for (User Defined Position Display Function) and (User Defined Speed Display Function) is supported by V1.10 or above.
3. Virtual axis selection is supported by OS ver. 1.20 or above.

4.2.2 Basic parameter setting

(1) Unit

- (a) You can set the command unit for positioning control according to control object. The command unit (mm, inch, pulse, degree) can be set for each axis separately.
- (b) In case of changing the unit setting, as the value of other parameter and operation data does not change, the value of parameter or operation data should be set within the setting range of the unit to be changed.

Ex) mm, inch, pulse : X-Y Table, Conveyor
 degree : a body of rotation (360degree/rotation)

(2) Pulse per Rotation

- (a) Only in case of using mm, inch, degree as a positioning command unit, you should set pulse per rotation
- (b) If the value does not correspond with parameter value of servo drive, command and motor action can be different.

$$\text{Travel per pulse} = \text{Transfer per rotation (Al)} / \text{Pulse per rotation (Ap)}$$

(3) Travel per rotation and unit multiplier

- (a) Only in case of using mm, inch, degree as a positioning command unit, you should set travel per rotation and multiplier
- (b) Machine's travel per rotation of motor is determined by the structure of machine.
 If the lead of ball screw (mm/rev) is PB and the rate of deceleration is 1/n,

Transfer amount per rotation (AL) = PB × 1/n.

- (c) Settable Travel per rotation (Al) is listed below

Setting unit	mm	Inch	degree
Travel per rotation	0.1 ~ 20000000.0 μm	0.00001 ~ 2000.00000 inch	0.00001 ~ 2000.00000 degree

In case transfer amount AL exceeds the above range, the travel per rotation (Al) should be set as follows:

$$\begin{aligned} \text{Transfer amount (AL)} &= \text{PB} \times 1/n \\ &= \text{Travel per rotation (Al)} \times \text{Unit multiplier (Am)} \end{aligned}$$

Remark)

In case unit is mm, unit multiplier (Am) is 1,10,100,1000. If the value of "PB × 1/n" exceeds 20000000.0 μm, it is required to adjust the unit multiplier so that the travel per rotation (Al) does not exceed 20000000.0 μm.

Ex1) In case that (AL) = PB × 1/n = 2500000.0 μm (= 2500 mm),
 (AL) = (Al) × (Am) = 25000000 × 1

Ex2) In case that $(AL) = PB \times 1/n = 25000000.0 \mu\text{m}(= 25000 \text{ mm})$,

$$\begin{aligned} (AL) &= (AI) \times (Am) = 25000000 \times 10 \\ &= 2500000 \times 100 \end{aligned}$$

(4) Speed Limit, Acceleration Time, Deceleration Time

(a) Speed Limit

Speed limit is maximum speed can be set by positioning operation.

All of the operating speed should be set to be lower than speed limit in positioning operation.

(b) Acceleration Time

The time required to reach from speed “0” (stop state) to the speed limit which is set by parameter.

(It doesn't mean that the time require to reach to the operation speed.)

(c) Deceleration Time

The time required to reach from the speed limit set by parameter to the bias speed “0” (stop state).

(It doesn't mean that the time require to reach from the operation speed to the speed “0”.)

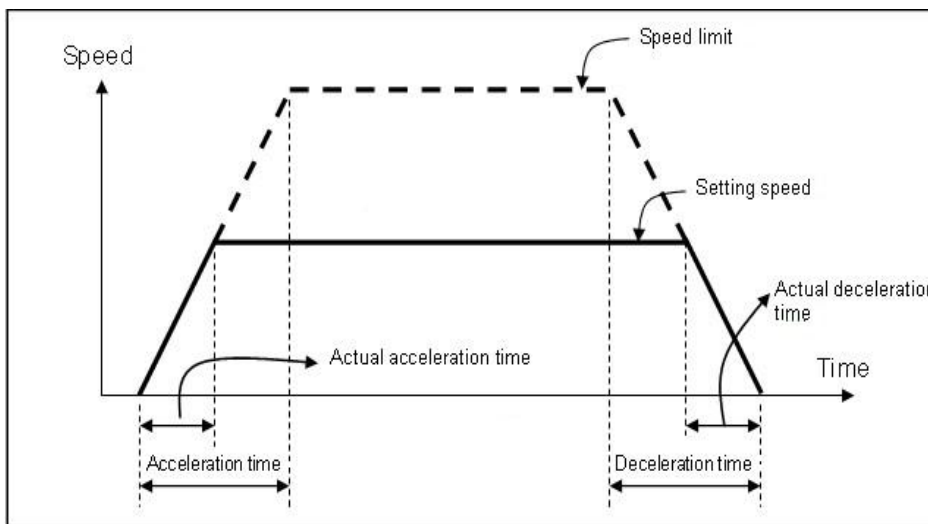

(5) Encoder Select

(a) It sets up the encoder type. If you use absolute position system, select 1: absolute encoder.

(b) The following describes setting of 「Encoder Select」

Item	Setting value	Contents
Encoder select	0: Incremental encoder	After power On/Off, it doesn't keep previous position of the servo motor. After power On/Off, "Origin Fix" status is always off.
	1: Absolute encoder	Absolute position system is activated. After power On/Off, it keeps previous position of the servo motor. For "Origin fix" status, it keeps previous status, too.

(6) Current Position Display Correction

- (a) The Current Position Display Correction is a parameter used to display the current position value of the servo motor as an command position without displaying it as a fixed value according to user applications and gain setting if there are little changes in the current position value.
- (b) If not during the operation, display the current position value as command position value when the difference between the command position and the current position is within the Current Position Display Correction.
- (c) The following values can be set as the Current Position Display Correction.

Setting unit	pulse	mm	Inch	degree
Current Position Display Correction	0 ~ 255	0.0 ~ 25.5 um	0.0 ~ 0.00255 inch	0.0 ~ 0.00255 degree

(d) The following shows an example of the Current Position Display Correction according to its value when the command location is 0.

- ① Current Position Correction = 0 pls
 - The motor's actual position value is still displayed as the current position value even after the operation is finished.

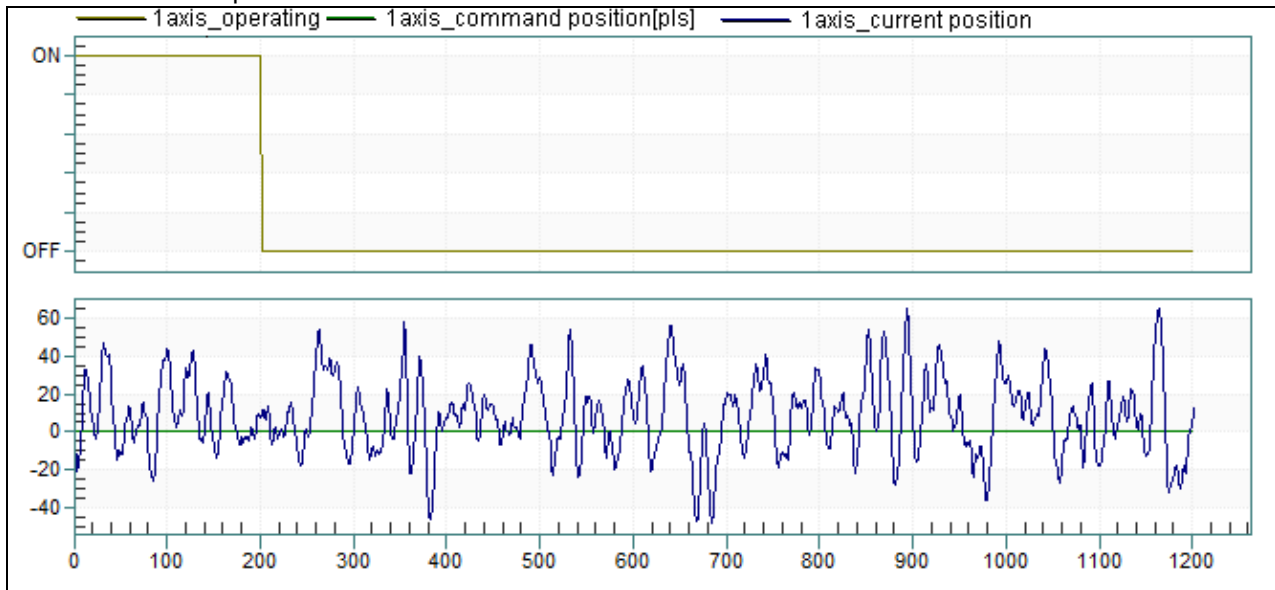

- ② Current Position Correction = 50 pls
 - If current position value is within ± 50 from the command position after the operation is finished, the command position value is displayed.

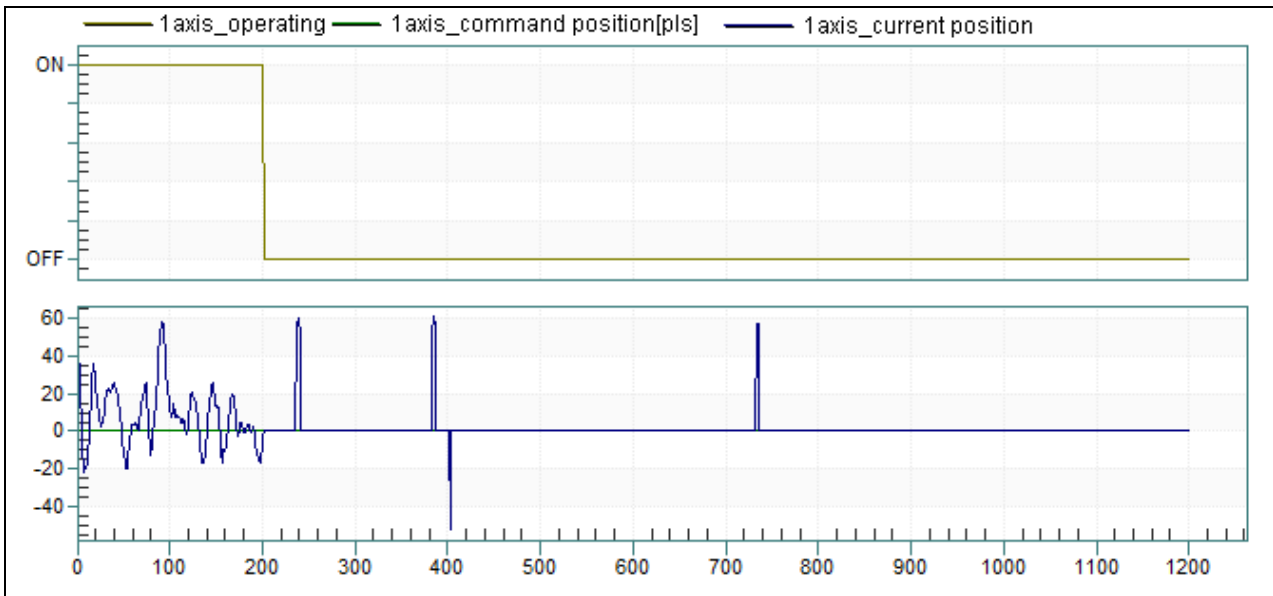

③ Current Position Correction = 100 pls

- If current position value is within ± 100 from the command position after the operation is finished, the command position value is displayed.

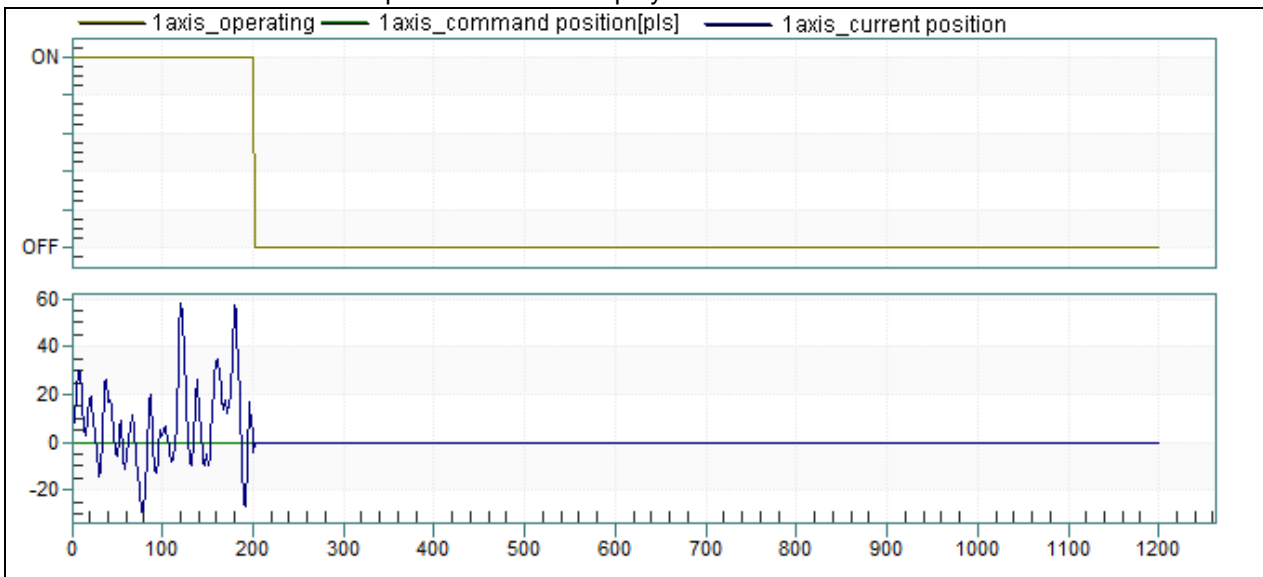

(7) Speed command unit

- It set the reference unit of velocity that is used for position control commands. If set to '0: unit/time', it is applied to the second rate of change of the relevant unit position is set to 「unit」 parameter. For example, 「unit」 setting is mm, speed command is 'mm/s'. If set to '1:rpm', speed command unit is rpm.
- If Speed command unit is rpm, setting value at 「Pulse per rotation」 and 「travel per rotation」 is used at the time of internal conversion to unit speed. To change the setting of the speed command unit, the values of other parameters or variables, because not changed, to modify this parameter, related parameters are also to be set again to match the set range at the unit.

(8) User Defined Position Display Function

- (a) The user sets the desired magnification as parameters for the position and speed and convert them to 'user defined position', 'user defined speed' values for use.
- (b) User defined position magnification are applied to the position and speed as follows.
 User defined position = Unit position x 10^{-N} (integer value, omit decimals)
 - ※ 'Unit position': The command position integer value or current position read by SRD command
 - ※ N: 'User defined position display magnification' of the basic parameter (0 ~ 7)
 - ※ If N = 0, user defined position and unit position values are the same
- (c) User defined position display value can be set range of the 0 ~ 7
- (d) The version information that you can use your current location correction function is shown below.

	Version
XBF-PN04B OS	V1.10 or above
XBF-PN08B OS	V1.50 or above
XG5000	V4.07 or above

(9) User Defined Speed Display Function

- (a) The user sets the desired magnification as parameters for the position and speed and convert them to 'user defined position', 'user defined speed' values for use.
- (b) User defined speed magnification are applied to the position and speed as follows.
 User defined speed = Unit speed x 10^{-N} (integer value, omit decimals)
 - ※ 'Unit speed': The command speed integer value or current speed read by SRD command
 - ※ N: 'User defined speed display magnification' of the basic parameter (0 ~ 7)
 - ※ if N = 0, user defined speed and unit speed values are the same
- (c) User defined speed display value can be set range of the 0 ~ 7
- (d) The version information that you can use your current location correction function is shown below.

	Version
XBF-PN04B OS	V1.10 or above
XBF-PN08B OS	V1.50 or above
XG5000	V4.07 or above

(10) Axis type

- (a) In order to use the virtual axis, to set whether the virtual axis. '1: If it is set as a virtual axis, even though the actual motor connected to the servo drive, Virtually it operates to control the motor.
- (b) Command is as follows which cannot be used in the virtual axis. With the exception of the command, user can use in a virtual axis as a command axis.

Command	XBC command	XEC FB
Position / torque control conversion switch	XPTT	XPM_PTT
External position / torque control conversion	XSEST	XPM_SIPT
Read the servo error information	-	XPM_SVERD
Reset the servo error	XSCLR	XPM_SRST
Reset the servo error history	XSECLR	XPM_SHRST
Read the servo drive parameters	XSVPRD	XPM_SVPRD
Write the servo drive parameters	XSVPWR	XPM_SVPWR
Save the servo drive parameters	XSVSAVE	XPM_SVSAVE
Torque control	XTRQ	XPM_TRQ
Read the latch position data	XLRD	XPM_LRD
Latch reset	XLCLR	XPM_LCLR
Set the latch	XLSET	XPM_LSET
Torque synchronous	XSTC	XPM_STC

(c) The version information shown below that support virtual axis.

Item	Supported version
XG5000	V4.09 or above
XBF-PN04B	V1.20 or above
XBF-PN08B	V1.20 or above

4.3 Extended Parameter

It describes about extended parameter of positioning module.

4.3.1 Contents of extended parameter

Extended parameter Items		Setting Range
Software upper limit		mm: -2147483648 ~ 2147483647[X10 ⁻⁴ mm] Inch: -2147483648 ~ 2147483647[X10 ⁻⁵ Inch]
Software lower limit		degree: -2147483648 ~ 2147483647[X10 ⁻⁵ degree] pulse: -2147483648 ~ 2147483647[pulse]
Infinite running repeat position		mm: 1 ~ 2147483647[X10 ⁻⁴ mm] Inch: 1 ~ 2147483647[X10 ⁻⁵ Inch] degree: 1 ~ 2147483647[X10 ⁻⁵ degree] pulse: 1 ~ 2147483647[pulse]
Position completion time		0 ~ 65,535 [unit: ms]
S-Curve ratio		1 ~ 100 [unit: %]
In-position width		mm: 0 ~ 2147483647[X10 ⁻⁴ mm] Inch: 0 ~ 2147483647[X10 ⁻⁵ Inch]
Arc insertion position in 2-axis linear interpolation continuous operation		degree: 0 ~ 2147483647[X10 ⁻⁵ degree] pulse: 0 ~ 2147483647[pulse]
Control Word	Cam restart(bit 0)	0: Disable, 1: Enable
	Acceleration/Deceleration pattern (bit 1)	0:Trapezoid operation, 1:S-Curve operation
	M Code mode (bit 2 ~ 3)	0:NONE, 1:WITH, 2:AFTER
	Software limit detect (bit 5)	0:Don't detect, 1: Detect
	Interpolation speed selection (bit 4)	0: main axis speed, 1: synthetic speed
	External command selection (bit6 ~ 7)	0: External VTP, 1: External stop, 2: External latch
	External command (bit8)	0: Disable, 1: Enable
	Speed/Position switching coordinate(bit9)	0: incremental, 1: absolute
	Positioning complete condition (bit 10 ~ 11)	0 : Dwell time 1 : In-position 2 : Dwell time and in-position 3 : Dwell time or In-position
	Infinite running repeat (bit 12)	0: Disable, 1: Enable
	Interpolation continuous operation Type (bit 13)	0 : Pass target position 1 : Pass near position
	Arc insertion in 2-axis linear interpolation continuous operation (bit 14)	0 : Don't insert 1 : Insert arc continuous operation
	Pos.-specified speed override coordinate (bit 15)	0: absolute, 1: incremental

Remark

External command selection and external command items are applied only when LS MECAPIONL 7N servo drive is used. The servo drive's DI#1 signal is used as external command. To use DI#1 as external command signal, do not assign other functions to DI#1 in Defining Servo Parameter Input Signal (0x2200, 0x2201) item.

4.3.2 Extended parameter setting

(1) Software Upper/Lower Limit

- (a) The function is designed so that the machine does not execute the positioning operation out of the range by setting the range of machine available to move through software upper limit and software lower limit. That is, this function is used to prevent any breakaway by incorrect operation position setting and incorrect operation by user program fault.
- (b) External input upper/lower limit can be also set besides the software upper/lower limit.

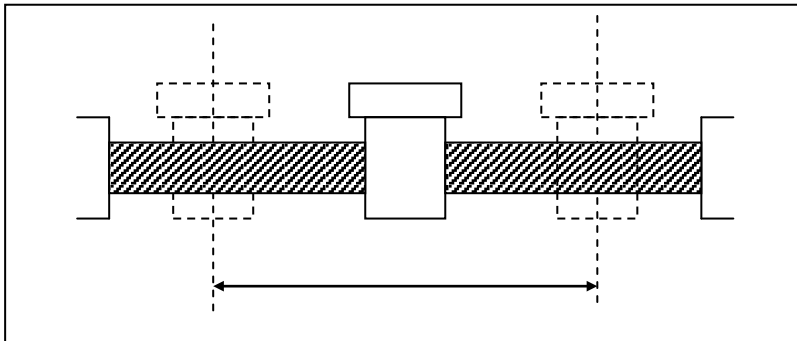

- (c) The range check of software upper/lower limit shall be done at the start of operation and during operating.
- (d) If the software upper/lower limit is detected, error (Software upper limit error: 501, Software lower limit error: 502) occurs and the pulse output of positioning module shall be disabled. Therefore, when you want to operate again, it is required to reset error.
- (e) Setting range

Unit	Software upper/lower limit range
pulse	-2147483648 ~ 2147483647 [pulse]
mm	-2147483648 ~ 2147483647 [$\times 10^{-4}$ mm]
Inch	-2147483648 ~ 2147483647 [$\times 10^{-5}$ Inch]
degree	-2147483648 ~ 2147483647 [$\times 10^{-5}$ degree]

But Software upper limit value always should be higher than software lower limit, at least same.

- (f) If the software upper/lower limit was set by default value (upper limit: 2,147,483,647, lower limit: -2,147,483,648) or same value, then it wouldn't detect upper/lower limit.

(2) Infinite running repeat position

- (a) When using “Infinite running repeat” mode, it sets the repeated position value.
- (b) This is applied when “Infinite running repeat” in the extended parameter is “1: Enable”. When this parameter setting value is “0: Disable”, command position and current position is expressed within position expression range according to value set in “Unit” of basic parameter.
- (c) When “Infinite running repeat” parameter is “1: enable”, command position and current position is expressed as 0 ~ “infinite running repeat position-1”.

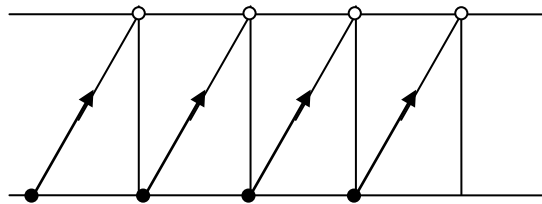

- (d) Setting range

Unit	Infinite running repeat position range
pulse	1 ~ 2147483647[pulse]
mm	1 ~ 2147483647[X10 ⁻⁴ mm]
Inch	1 ~ 2147483647[X10 ⁻⁵ Inch]
degree	1 ~ 2147483647[X10 ⁻⁵ degree]

(3) Infinite running repeat

- (a) It sets whether to enable or disable “Infinite running repeat”
- (b) When you set “Infinite running repeat” as “1: enable”, command position and current position refreshes within the range set in “Infinite running repeat position” periodically.
- (c) When you don’t use “Infinite running repeat” function, set as “0: disable”.

(4) Positioning Completion Time

- (a) Positioning completion signal shall be OFF after sustaining “ON” for Positioning Completion Time after positioning is completed and positioning completion signal becomes “ON” in single operation, repeat operation, keep operation, continuous operation, linear interpolation operation, circular interpolation operation, speed/position switching control operation, inching operation
- At this time, if all start command is executed while positioning completion signal is ON, completion signal shall be OFF immediately. In case of keep operation and continuous mode operation, positioning completion signal will be on after all steps end.

(b) The setting range is 0 ~ 65,535 (unit: 1 ms).

(c) The action of single operation mode is as follows :

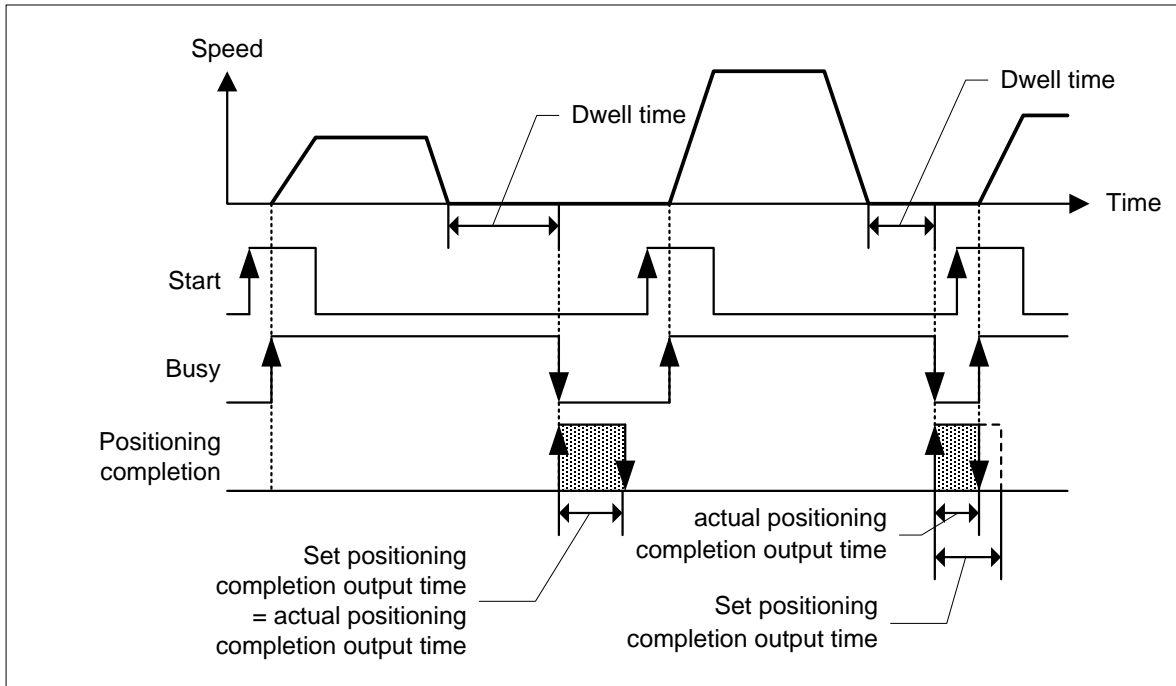

(d) The action of Keep operation mode is as follows :

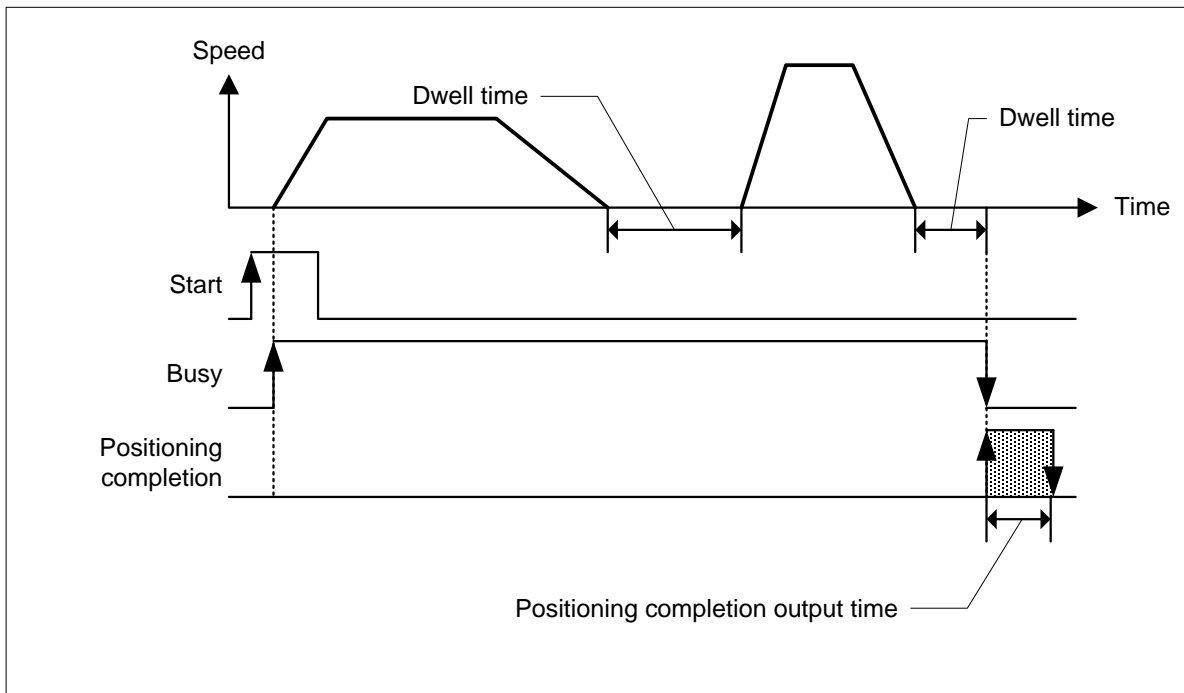

(e) The action of Continuous operation mode is as follows.

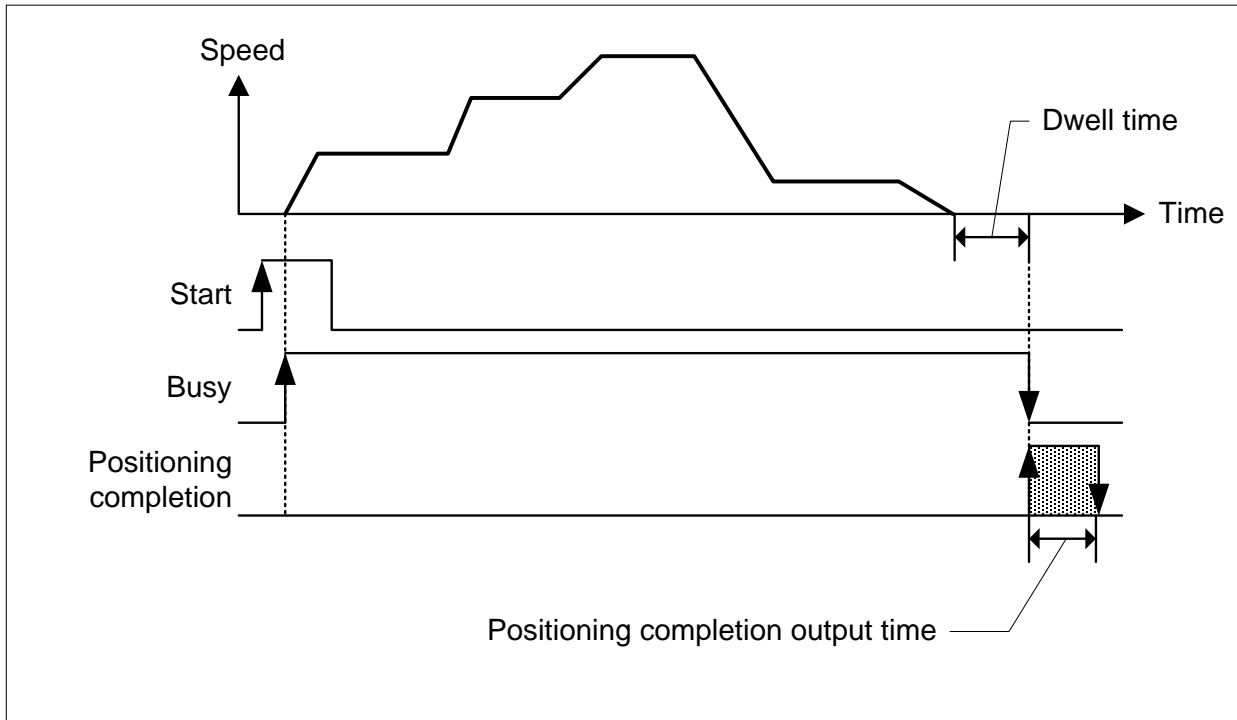

(5) M Code Mode

- (a) M code mode set by parameter shall be applied to all position data of the corresponding axis.
- (b) Available to set M code number differently at each operation step no. of positioning data.
- (c) M code number setting range : 1 ~ 65,535
- (d) Available to read and use M code for the identification of operation step no. in operation and the execution of auxiliary works (Clamp, Drill rotation, tool change etc).
- (e) M code signal occurring during the operation shall be reset by M code "Off" command.

Remark
 If you execute the next step after the positioning is completed and M code signal is "ON", the next operation step no. does not work and the error (In case of indirect start, E233) will occur. Therefore, in order to execute the positioning of the next operation step number, M code signal should be "OFF" by M code "Off" command

- (f) There are two kinds of M code mode according to the output timing of M code signal: With mode and After mode.
 (In case of setting NONE, There is no M code signal, even if M code No was set.)

1) With mode

It turns on the M code signal and outputs M code number with start of positioning [Indirect start, direct start and simultaneous start].

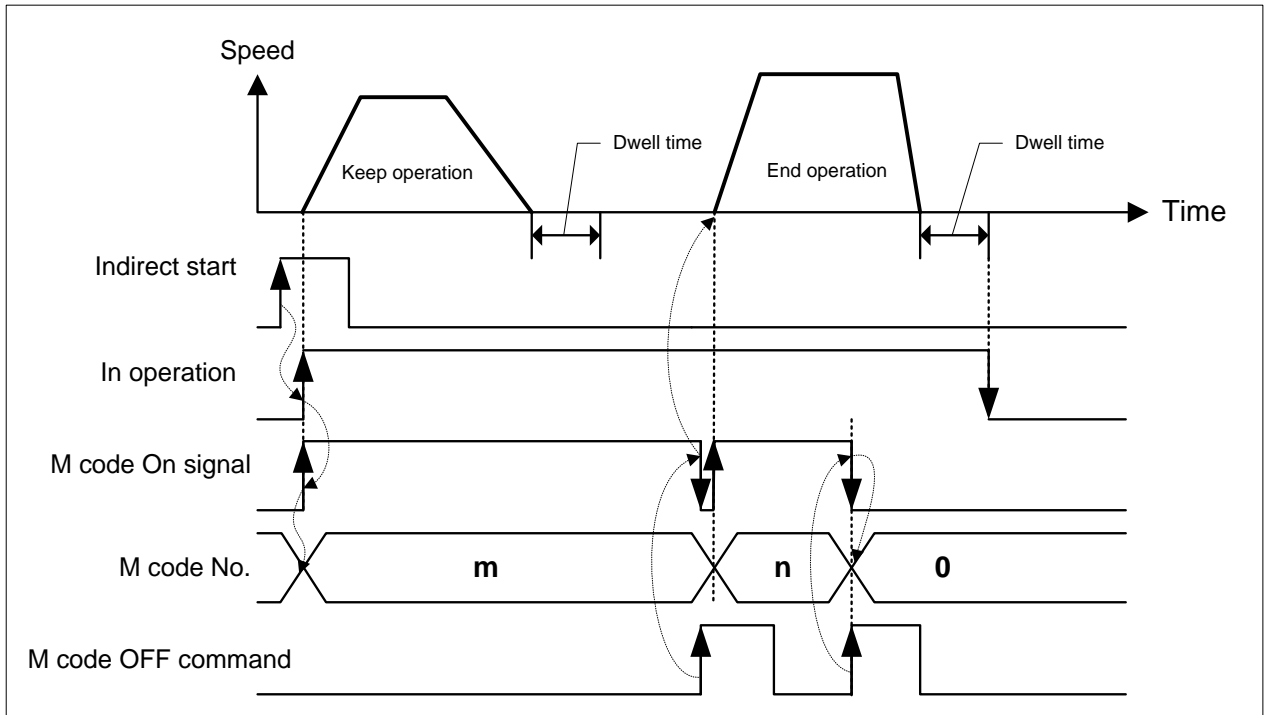

2) After mode

It turns on the M code signal and outputs M code number after completion of positioning [indirect start, direct start, simultaneous start].

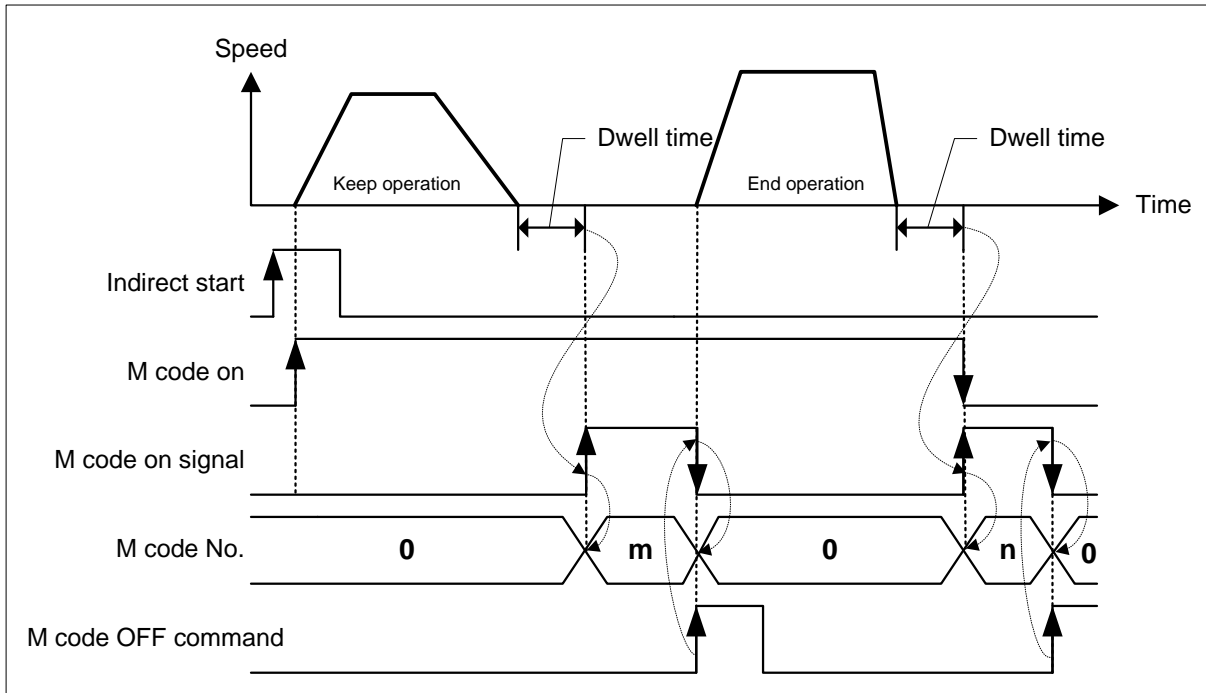

(6) Enable/disable external command

- (a) If selecting and using one among External Speed/Location Control Shift, External Stop Command, External Latch Command, set the external command Enable/Disable to “Enable”.
- (b) If “Disable” is set, it won’t work even though one among “External Speed/Location Control Shift”, “External Stop Command” and “External Latch Command” is selected.
- (c) It is valid only when LS MECAPIONL 7N servo drive is used. The servo drive’s DI#1 signal is used as external command.

(7) External command selection

- (a) Set which one will be used among “External Speed/Location Control Shift”, “External Stop Command”, “External Latch Command” as external command.
- (b) If you make the selected external command operated by the external signal, enable “External command” item.
- (c) It is valid only when LS MECAPIONL 7N servo drive is used. The servo drive’s DI#1 signal is used as external command. To use D1#1 as external command signal, do not assign other functions to DI#1 in Defining Servo Parameter Input Signal (0x2200, 0x2201) item.
- (d) Use the servo drive’s touch probe Input 1 signal instead of external command signal for latch function.

(8) Software limit detect

- (a) Selects whether to stop the operation or not when detecting software limit.
- (b) If the software upper/lower limit is set as default value (upper limit: 2,147,483,647, lower limit: -2,147,483,648) or same value, it wouldn't detect software upper/lower limit.

(9) Acceleration/Deceleration Pattern

- (a) There are 2 kinds of Acceleration/Deceleration operation pattern: Trapezoid operation and S-Curve operation.
- (b) In case of positioning operation, it is available to select operation pattern (either trapezoid operation or S-Curve operation) at the section of acceleration and de deceleration.
- (c) As it is not possible to use S-Curve operation pattern in case of continuous operation mode and speed override, care should be taken in setting.
- (d) In case of using S-Curve acceleration/deceleration, it is available to protect the motor from the load effect at the point that the motor starts to move the moving object and stops it.

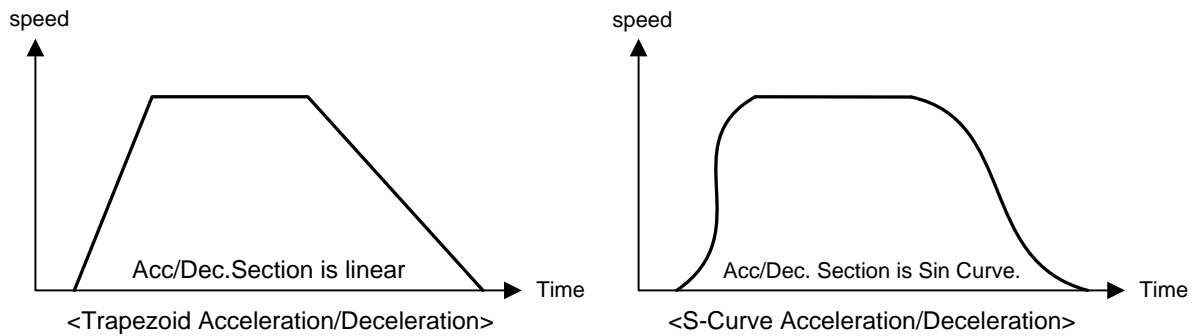

(10) S-curve rate

- (a) In case of selecting S-Curve operation as an acceleration/deceleration pattern, S-Curve rate (1~100%) should be set.
- (b) According to S-Curve rate, S-Curve operation pattern shall be formed in accordance with sine curve.
- (c) If S-Curve rate is 1%, it becomes the same as trapezoid operation and if the 100% rate is set, it becomes the acceleration/deceleration curve which is the closest to the Sin Curve.
- (d) The figure as below shows the example of S-Curve rate setting

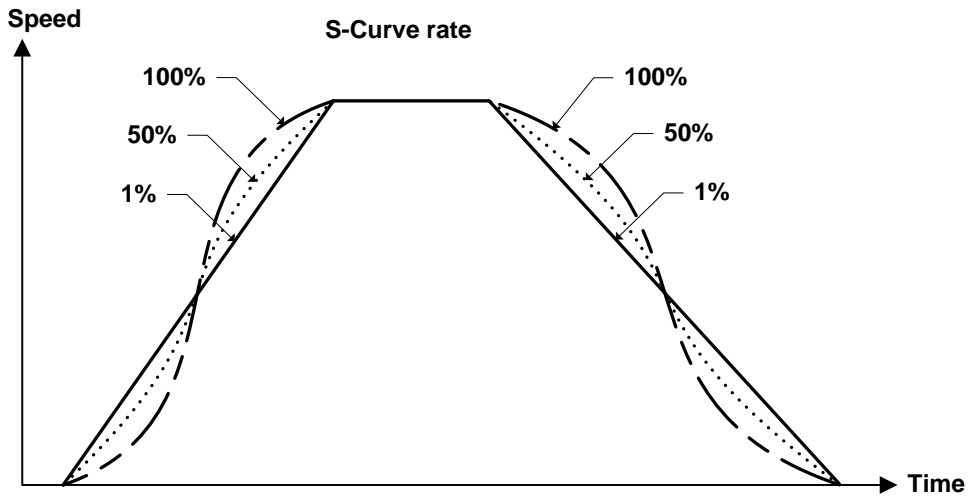

(11) In-position width

- (a) Sets the position range from the target position where In-position signal (External signal Bit 11) is ON.
- (b) When positioning starts, In-position signal is OFF, and if it goes in "In-position width" from target position, it will be ON.
- (c) In-position signal can be used as a trigger when you execute auxiliary work before positioning

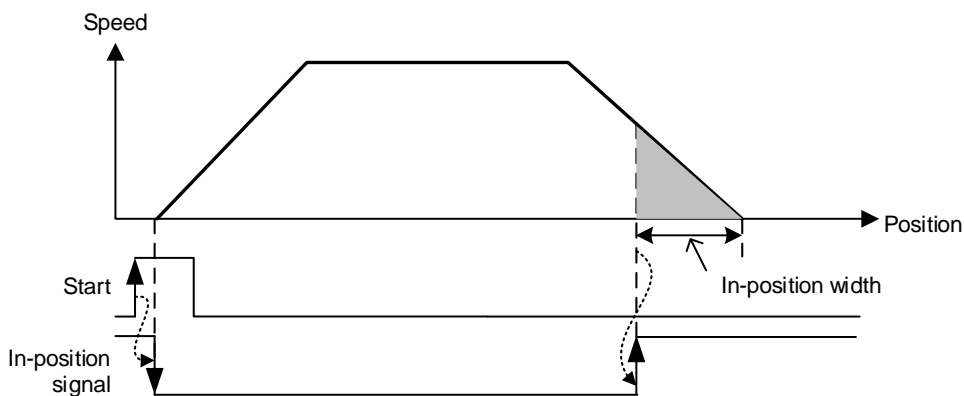

- (d) Because inposition signal operates on the basis of the current position, it may signal occurs after arriving at command position.

(e) In case of the followings, it doesn't check "In-position".

- 1) Stop by Dec. stop or Emg. Stop command
- 2) Speed control

(f) In case of the followings, it turns off "In-position" signal.

- 1) When executing "floating origin setting" command
- 2) When executing "Current position preset" command
- 3) When turning SERVO off
- 4) When starting positioning

(g) Setting range

Unit	Setting range for in-position width
pulse	0 ~ 2147483647[pulse]
mm	0 ~ 2147483647[X10 ⁻⁴ mm]
Inch	0 ~ 2147483647[X10 ⁻⁵ Inch]
degree	0 ~ 2147483647[X10 ⁻⁵ degree]

(12) Positioning Completion Condition

(a) Positioning Completion signal notify that operation has been completed without stop factor

(b) There are 4 kinds of methods for positioning completion condition.

- 1) by dwell time
- 2) by in-position signal
- 3) by using both dwell time and in-position signal
- 4) by using either dwell time or in-position signal.

(c) Though target reaches goal position and positioning is complete, "in operation" status is kept until positioning completion condition is met. If positioning completion condition is met, "in operation" signal will be off and it goes to "Positioning completion" status.

(d) The following is timing diagram for each method.

1) Method by dwell time

If it reaches goal and stops, positioning complete signal will be on after Dwell time

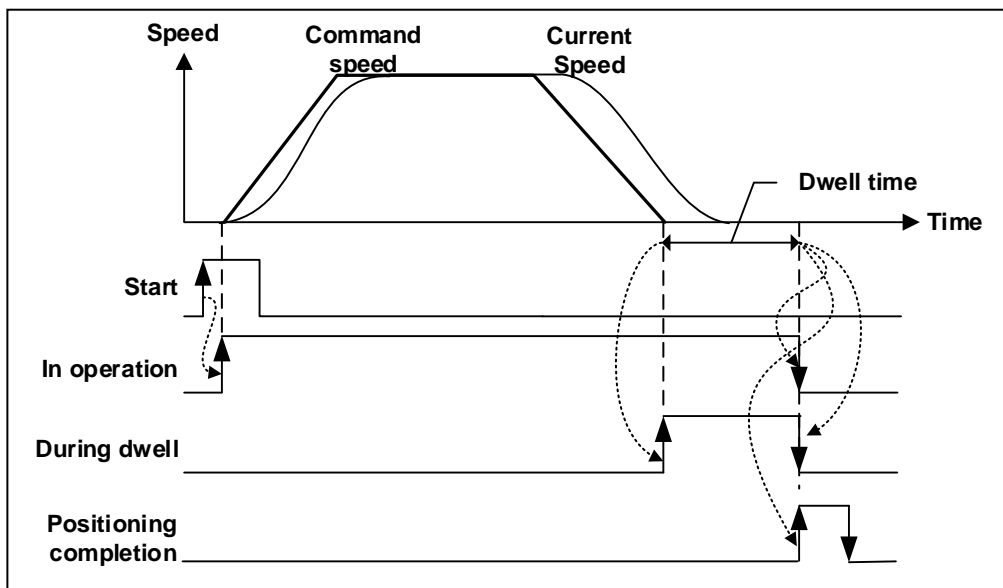

2) Method by in-position signal

- a) In case that in-position signal becomes ON before positioning is completed
 Positioning complete signal will be on when reaching goal and positioning is completed

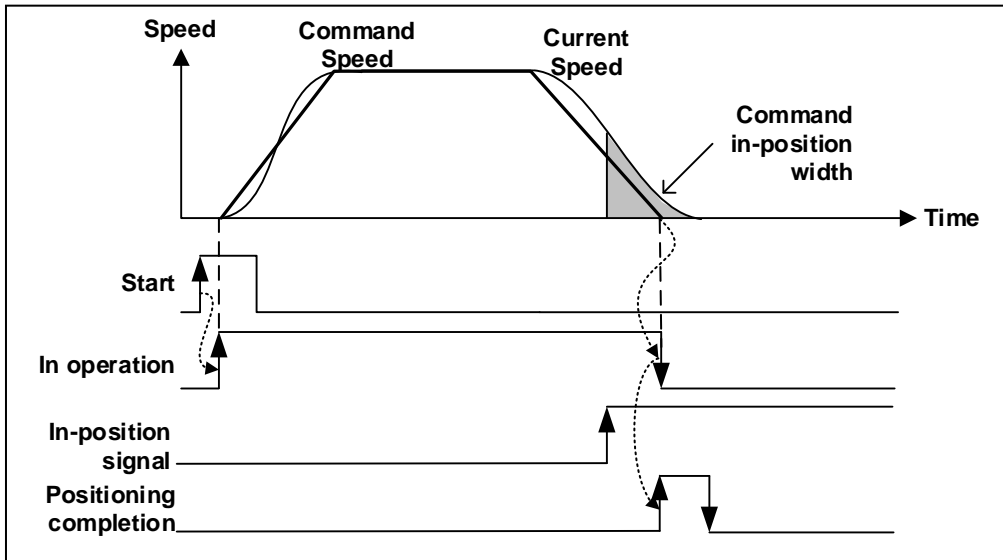

- b) In case In-positioning signal becomes on after positioning is completed.
 After reaching goal and positioning is completed, wait until In-position signal becomes on. When In-position signal becomes on, positioning complete signal will be on.

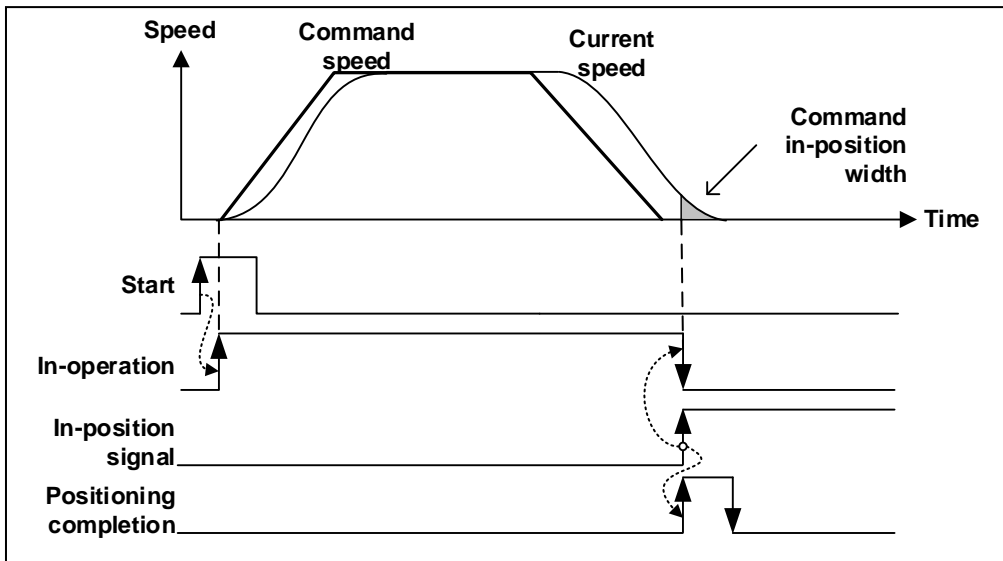

3) Method by using both dwell time and in-position signal

a) In case that in-position signal occurs before dwell time is ended

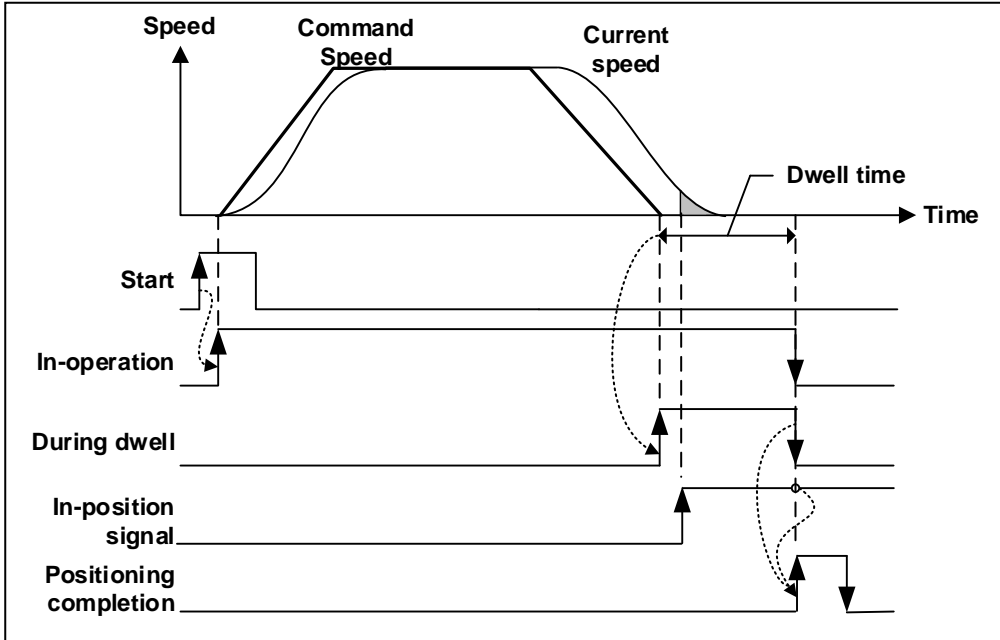

b) In case that in-position signal occurs after dwell time is ended.

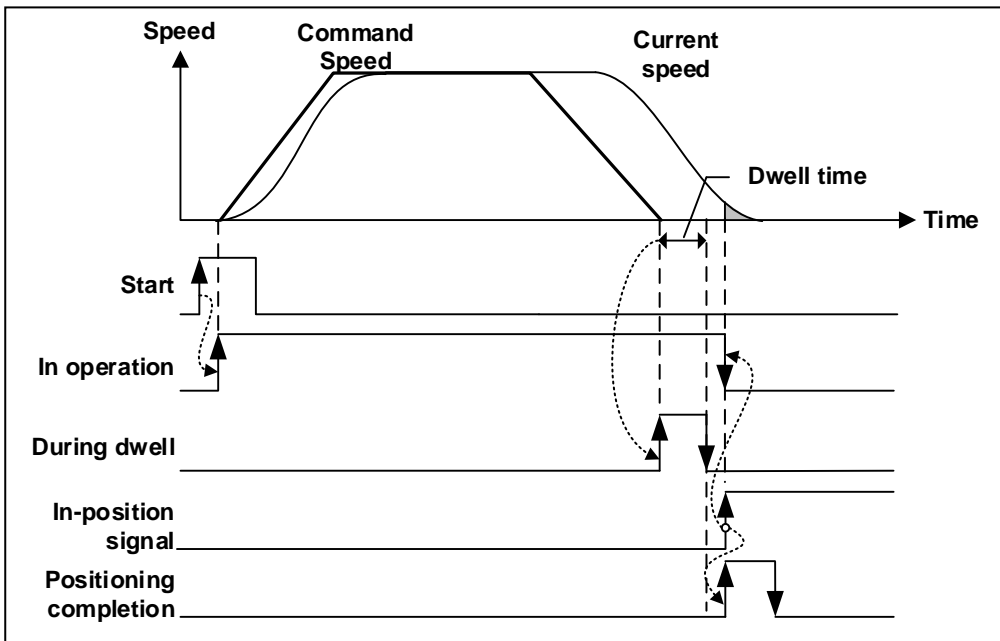

c) In case that in-position signal occurs during pulse output

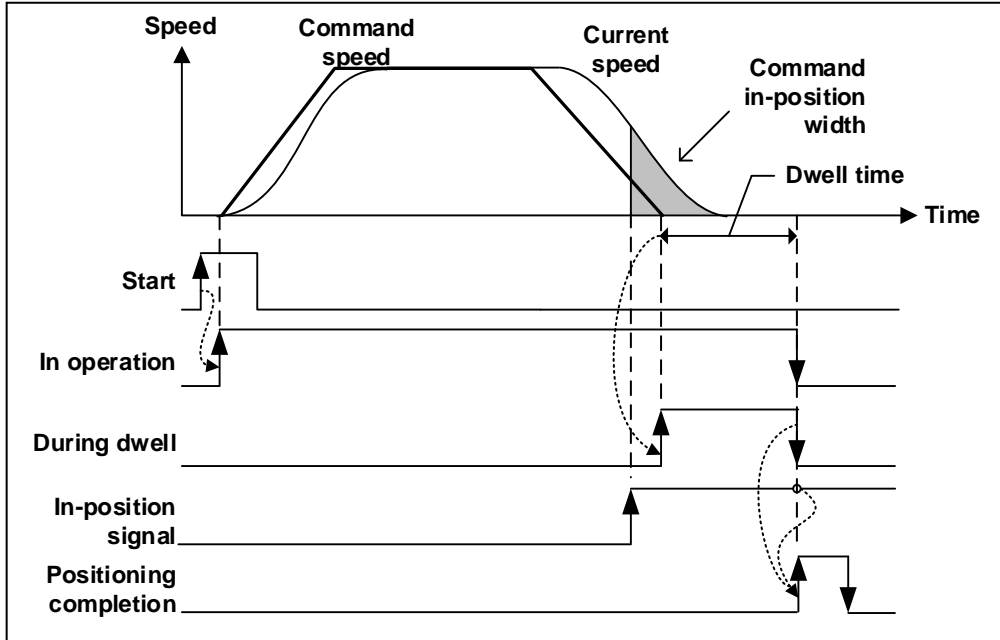

4) Method by using either dwell time or in-position signal

a) In case that in-position signal occurs before dwell time is ended

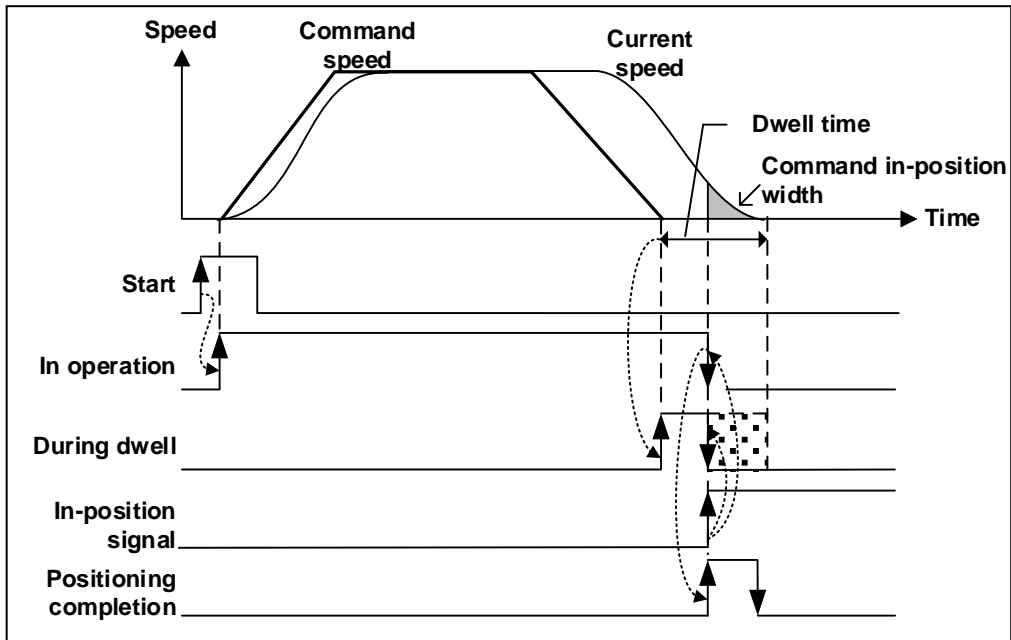

b) In case that in-position signal occurs after dwell time is ended.

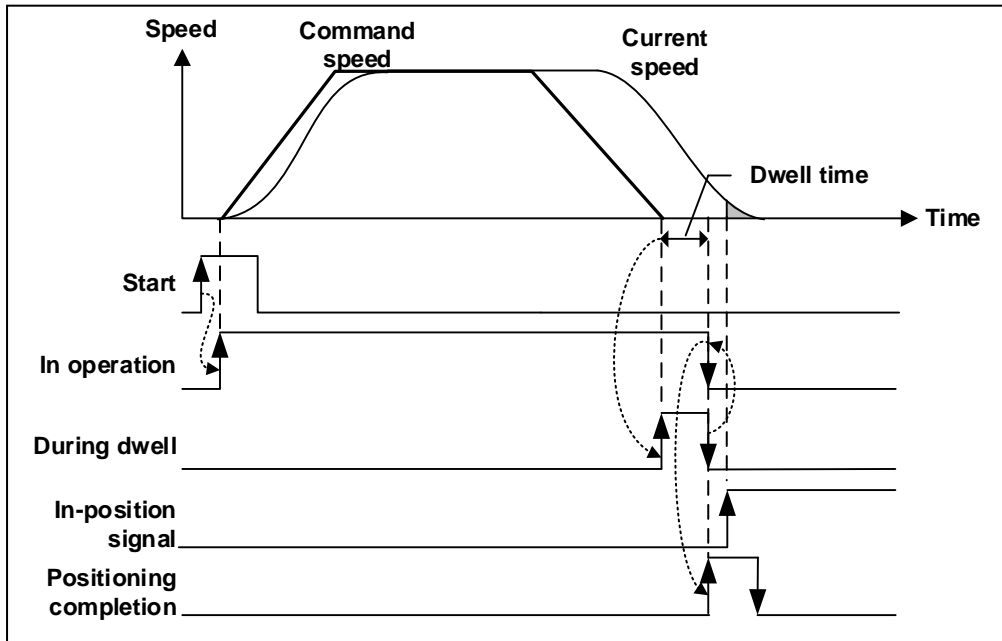

(13) Interpolation continuous operation method

In case control method is linear interpolation or circular interpolation and operation method is continuous operation, positioning control will be different in accordance with the value set in 「 Int continuous opr. Type 」 .

Items	Setting value	Description
Interpolation continuous operation method	0 : Pass target position	In case of continuous operation from current step to next step, it passes target position of current step
	1 : Pass near position	In case of continuous operation from current step to next step, it passes near target position of current step

For further information, please refer to operation mode (4)-(c) continuous operation of 9.2.2 positioning control.

(14) Arc insertion during 2-axis linear interpolation continuous operation

When executing linear interpolation, determine whether to add arc during 2-axis linear interpolation continuous operation.

Here describes Arc insertion during 2-axis linear interpolation continuous operation

Setting item	Setting Value	Content
Arc insertion during 2-axis linear interpolation continuous operation	0 : Don't insert	When executing 2-axis linear continuous interpolation, doesn't inserts arc.
	1 : insert arc	When executing 2-axis linear continuous interpolation, inserts arc.

For further information about Arc insertion during 2-axis linear interpolation continuous operation, please refer to (4) 2-axis linear interpolation continuous operation arc insertion of 2-axis linear interpolating control of 9.2.6.

(15) Arc insertion position

When 「Arc insertion」 was set as “insert arc”, confirms the arc insertion position and resets the start position of circular interpolation(Goal position of linear path 1) and goal position(Start position of linear path 2).

This is the setting of ‘Arc insertion position’.

Setting item	Setting value	Content
Arc insertion position	0 ~ 2147483647	Set the position where circular will be inputted. It is relative distance from goal position.

For further information about inputting circular arc in 2-axis linear interpolation continuous operation, please refer to (4) inputting circular arc in 2-axis linear interpolation continuous operation of control linear interpolation (9.2.6).

(16) Position-specified speed override coordinate

Position-specified speed override command is the command changing the operation speed when the object reaches the specified position. At this time, operation may be different according to the type of position value. Position value can be absolute position value or incremental position value.

This is the setting of 'Position-specified speed override coordinate'.

Item	Setting value	Content
Position-specified speed override coordinate	0 : ABS	Speed changes at the specified absolute position.
	1 : INC	Speed changes at the position as far as the set value from start position.

For further information, refer to 9.5.6 position-specified speed override.

(17) Speed/Position switching coordinate

If "Speed/Position switching signal" is inputted during speed control, speed control changes into position control and executes position control with the value set in target position. At this time, this sets whether to consider the target position as absolute position value or incremental position value.

This is the setting of "Speed/Position switching coordinate".

Item	Setting value	Content
Speed/position switching coordinate	0 : INC	Executes positioning as far as the set value from position where speed/position switching command is executed.
	1 : ABS	Considers the set value as absolute position and executes positioning into the set absolute position.

For further information, refer to 9.2.14 speed/position switching control.

(18) Interpolation speed selection

It selects whether to consider the operation speed of the position data as main axis speed or synthetic speed.

For detailed comparison, refer to the example calculating interpolation speed in Ch9.2.6 and Ch9.2.7.

(19) Cam Restart

If main/sub axis is stopped by abnormal operation such as error, emergency stop during cam operation, sub axis is restarted by starting CAM operation from stop position.

Item	Setting value	Content
Cam restart	0 : Disable	After stopping the abnormal operation, when starting the CAM operation again, new CAM operation start regardless of the CAM
	1 : Enable	After stopping the abnormal operation, when starting the CAM operation again, previous cam operation is operated continuously

For further information, refer to 9.4.3 CAM operation.

4.4 Manual Operation Parameter

Here describes Manual operation parameter of positioning module.

Manual operation parameter is used for the operation of JOG, Inching.

4.4.1 Manual Operation Parameter

Manual operating parameter item	Setting range
JOG high speed	mm : 1 ~ 2,147,483,647 [$\times 10^{-2}$ mm/sec] Inch : 1 ~ 2,147,483,647 [$\times 10^{-3}$ Inch/sec]
JOG low speed	degree : 1 ~ 2,147,483,647 [$\times 10^{-3}$ degree/sec] pulse : 1 ~ 2,147,483,647 [pulse/sec]
JOG acceleration speed (ms)	0 ~ 2,147,483,647 [ms]
JOG deceleration speed (ms)	
Inching Speed	mm : 1 ~ 65,535[$\times 10^{-2}$ mm/ min] Inch : 1 ~ 65,535[$\times 10^{-3}$ Inch/ min] degree : 1 ~ 65,535[$\times 10^{-3}$ degree/ min] pulse : 1 ~ 65,535[pulse/sec]

4.4.2 Manual Operation Parameter Setting

(1) JOG high Speed

- (a) Jog speed is related to Jog operation (a kind of manual operation) and has 2 types of operation : Jog low speed operation and Jog high speed operation.
- (b) For further information, please refer to 9.3.1 JOG Operation.
- (c) JOG high speed operation has operation pattern as acceleration, constant speed, deceleration section. Therefore, acceleration section and deceleration section is controlled by JOG acceleration/deceleration time.
- (d) Jog high speed setting range
All controls executed by the positioning module are done within speed limit. So Jog high speed can't exceed the speed limit. And, Jog high speed have to be larger than or same as Jog low speed.
Jog low speed \leq Jog high speed \leq Speed limit

(2) JOG Low Speed

- (a) JOG low speed operation has operation pattern as acceleration, constant speed, deceleration section.
- (b) JOG low speed setting range : 1 ~ Jog high speed

(3) JOG Acceleration/Deceleration Time

- (a) This means JOG acceleration/deceleration time when Jog high speed and low speed operation.
- (b) JOG acceleration/deceleration time setting range : 0 ~ 2,147,483,647 [ms]
In case of set by 0, operate set by acceleration time 1 and deceleration time of parameter.

(4) Inching Speed

- (a) The speed necessary for inching operation is set here.
- (b) Inching speed setting range : 1 ~ 65,535(unit/time)

4.5 Input Signal Parameter

Here describes input signal parameter of positioning module. Parameter of the input signal is a parameter that is used to the function of the command by the external input signal if you choose common parameter's 'external input terminal function selection' to '1:external input signal A,B,Z'.

4.5.1 Input signal parameter

Item of input signal parameter	Range
Function selection of input signal A	0: Unused 1: Switching speed/position control 2: Switching position/torque control 3: External operation
Function selection of input signal B	
Function selection of input signal Z	
Logic selection of input signal A	A Contact, B Contact
Logic selection of input signal B	
Logic selection of input signal Z	
Switching torque of external position/torque control	-32768 ~ 32767

4.5.2 Input signal parameter setting

(1) Function selection of input signal A,B,Z

(a) Function selection of input signal A, set whether to use an external command signal at any function. You can set the command that is the switching speed / position control, switching position/torque control and external operation.

0: Switching speed/position control

- Switch control to the position control from the speed control by the input signal.

1: Switching position/torque control

- Switch control to the torque control from the position control by the input signal.

2: External operation

- Execute operation data of current step number by the input signal

(b) After reflecting the contact condition set in the input signal A,B,Z logic selection when the value of the input signal is changed to On in the Off, function set for this parameter is executed.

(c) To turn on the set function to the logic selection of input signal A,B,Z, you need to set the 'function selection of external input terminal' item of common parameter to '1:external input signal A,B,Z'.

(2) Selection of input signal A,B,Z logic

(a) Select logic of input signal A,B,Z inputted to the module from external.

(b) If it is selected to B contact, if no current flows through the input signal terminal, the module recognizes to On, if the current flows, the module recognizes to Off.

(c) Please be careful when you want to change the setting because the user can not be operated successfully at any time, If you set the wrong logic of selection of the input signal

(3) Switching torque of external position/torque control

(a) Set the torque value at the time of switching the torque control in case that function selection of the input signal is set to '2: Switching position/torque control.

(b) Unit is %, you can set the torque value of -32768% ~ 32767%.

4.6 Common Parameter

Here describes common parameter of positioning module.

The common parameter is applied to the connected all axes.

4.6.1 Common parameter

Configuration of Common Parameter		Setting range
Control word	Encoder 1 pulse input (bit 0/1/2)	0:CW/CCW 1 multiplier 1:PULSE/DIR 1 multiplier 2:PULSE/DIR 2 multiplier 3:PHASE A/B 1 multiplier 4:PHASE A/B 2 multiplier 5:PHASE A/B 4 multiplier
	Encoder 1 Z phase clear (bit 3)	0: Disable, 1: Enable
	Speed override(bit 8)	0 : % designate, 1 : Speed designate
	Destination coordinates for positioning speed synchronization (bit 10)	0: Incremental 1: Absolute
	Encoder 1 average number(bit 11~12)	0: Disable, 1: 5 times, 2: 10times, 3: 20times
	Function selection of external input terminal (bit 15)	0: A,B,Z phase of encoder signal 1: External input signal A,B,Z
	Input filter of external input signal (bit 9)	0: Disable, 1: Enable
Encoder 1 Max. value	-2147483648 ~ 2147283647	
Encoder 1 Min. value		

4.6.2 Common Parameter Setting

(1) Encoder pulse input mode

- (a) If you want to use signal of a manual pulse generator or Servo drive encoder as input, you can select suitable signal for a manual pulse generator or Servo drive encoder.
- (b) You should select and set one from among CW/CCW 1 multiplier, PULSE/DIR 1 multiplier, PULSE/DIR 2 multiplier, PHASE A/B 1 multiplier, PHASE A/B 2 multiplier and PHASE A/B 4 multiplier as an encoder input signal.

1) CW/CCW 1 multiplier

When the Phase A input pulse was grow, or the phase B input pulse was grow, act to count.

It act to additional work when the Phase B input pulse is 'Low' and the Phase A input pulse is increased. It acts to cutback when the Phase A is 'Low' and the Phase B input pulse is grow.

Addition/Cutback	Phase A input pulse High	Phase A input pulse Low
Phase B input pulse High	-	Cutback count
Phase B input pulse Low	Addition count	-

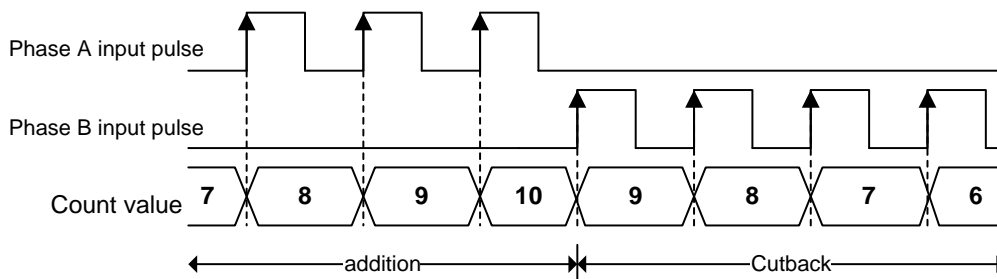

2) PULSE/DIR 1 multiplier

In case of increasing Phase A input pulse, act to count. Addition/cutback was decided by Phase B.

Addition/Cutback	Increasing Phase A input pulse	Decreasing Phase A input pulse
Phase B input pulse Off	Addition count	-
Phase B input pulse On	Cutback count	-

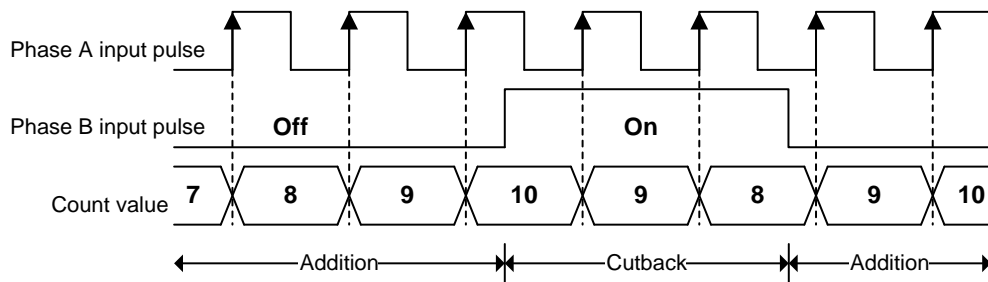

3) PULSE/DIR 2 multiplier

In case of increasing and decreasing Phase A input pulse, act to count. Addition/cutback was decided by Phase B.

Addition/Cutback	Increasing Phase A input pulse	Decreasing Phase A input pulse
Phase B input pulse Off	Additional count	Additional count
Phase B input pulse On	Cutback count	Cutback count

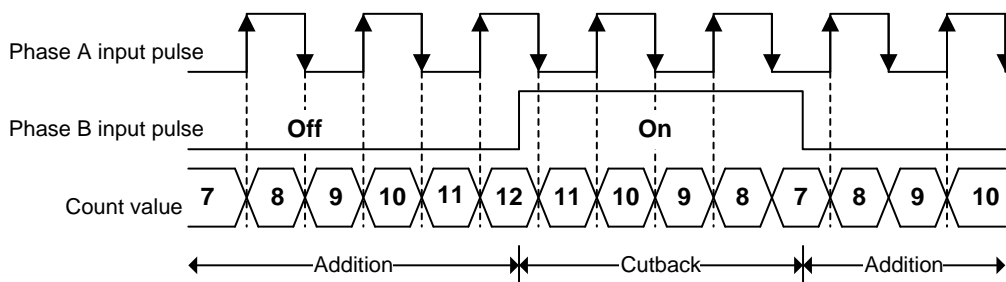

4) PHASE A/B 1 multiplier

In case of Phase A input pulse in advance of Phase B input pulse, Act to add when that Phase A increase pulse. In case of Phase B input pulse in advance of Phase A input pulse, Act to cutback when that Phase A decrease pulse.

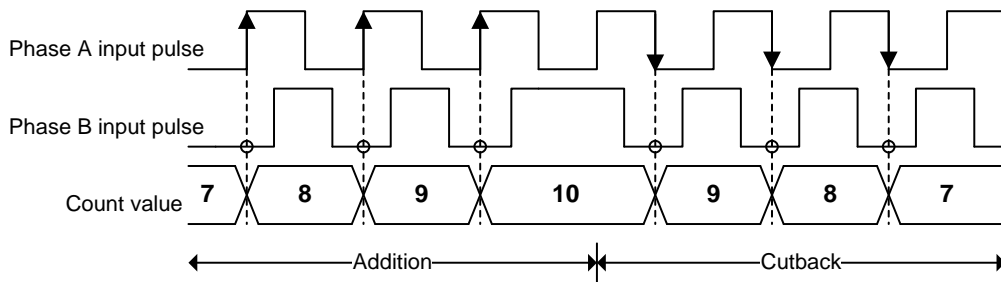

5) PHASE A/B 2 multiplier

Act to count when the Phase A increase/decrease. When Phase A input faster than Phase B at the Phase, act to decrease.

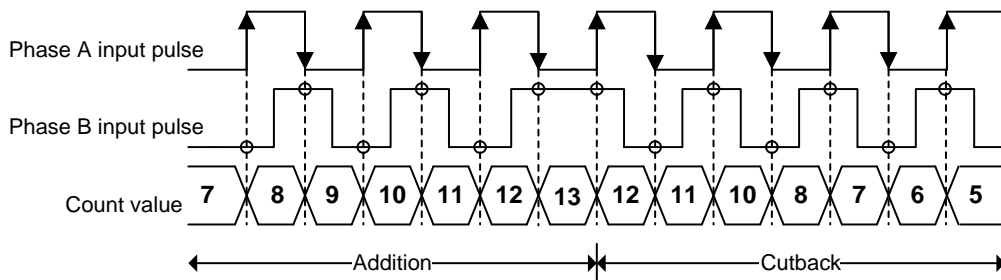

6) PHASE A/B 4 multiplier

Act to count when Phase A input pulse and Phase B input pulse is increased/decreased. In case that Phase A input faster than Phase B at the phase, act to add. In case that Phase B input faster than Phase A at the phase, act to decrease.

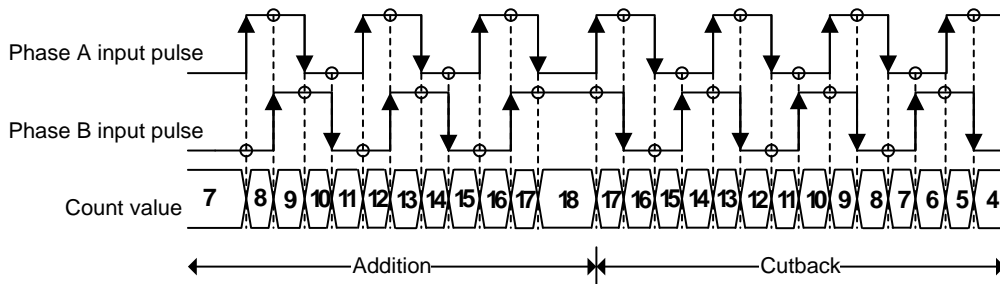

- (c) The main axis set encoder for that acting motor synchronization with manual pulse generator (MPG). Synchronization rate can take "Encoder ≤ Motor" or "Encoder ≥ Motor" what you want.

(2) Max/Min value of encoder

(a) When count Inputted pulse (from a hand pulse generator or encoder signal of Servo drive) and display as encoder value, the count range and range of encoder value need to be set to Max/Min value of encoder,

(b) The act follows the picture of below.

1) When encoder value increase

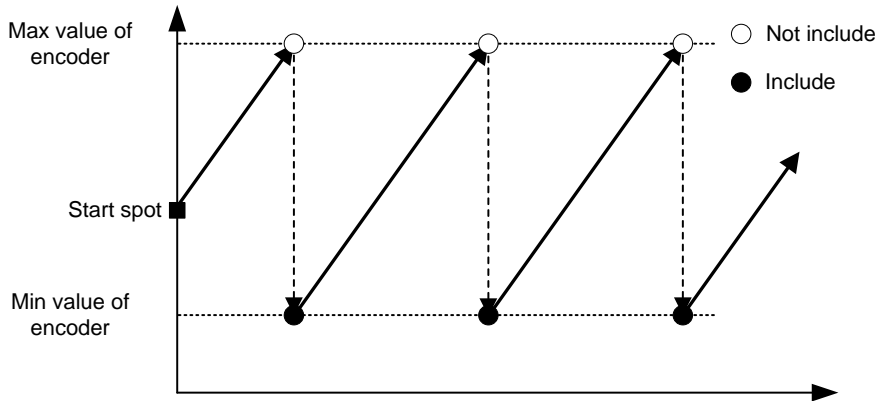

2) In case of decreasing encoder value

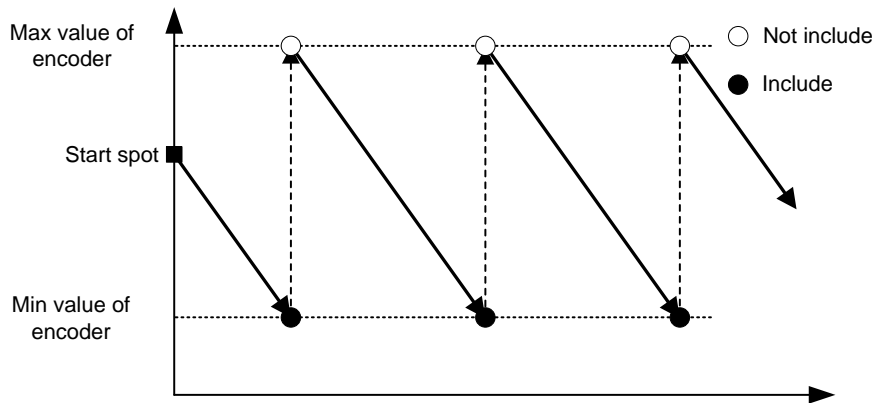

(c) If the range of encoder minimum and maximum value does not contain the current position of the encoder, when writing common parameter to module, error(error code:148) occur. In this case, Range of the minimum and maximum values of the encoder can operate in previously set value. If use encoder preset command and set the current position within a range minimum and maximum, the parameter of the newly set encoder minimum and maximum values are reflected.

(3) Speed override

- (a) When operate changing speed command (Speed override, Positioning speed override, etc), select speed(will be changed) or percentage of goal speed.
- (b) In case of setting percentage (%) can set each per 0.01% from 0.01% to 655.35%.

(4) Destination coordinates for positioning speed synchronization

- (a) When you perform positioning speed synchronization, set whether to use 'target position' as a relative position of the command time or an absolute position in absolute coordinates.
- (b) Possible values are as follows
0: Incremental, 1: absolute

(5) Encoder average number

- (a) You can set the number of times for averaging the input value of the encoder to reduce the encoder input speed deviation when synchronous operation of encoder as main axis.
- (b) The average functionality is applied to the input of the average number of times the current applied from the input value to the moving average.
- (c) Possible values are as follows
0: Disable, 1: 5 times, 2: 10times, 3: 20times

(6) Selection of external input terminal function

- (a) Set whether to use the external input terminal to any function.
- (b) Possible values are as follows
0: A,B,Z phase of encoder signal
1: External input signal A,B,Z
- (c) If external input terminal function selection is "1: If an external input signal A ', the value of the encoder position is maintained as 0 .
- (d) If external input terminal function selection is changed to '0: A,B,Z phase of encoder signal', the value of the position of the encoder is set to initial position(0 when the maximum value/minimum value contains 0, minimum value if not included) by checking the encoder maximum/minimum value parameter.
- (e) If external input terminal function selection is changed to '0: A,B,Z phase of encoder signal', Status of the external input signal of status information is all displayed as off.

(7) Input filter of external input signal

- (a) If external input terminal function selection is "1: If an external input signal A ', set whether or not of the application of the S/W filter to the input signal.
- (b) Possible values are as follows
0: Disable, 1: Enable

Remark

1. If you want to apply the input filter of the external input signal, signal of 2 control period or less is not be recognized On, because filter time is applied about 2 control period. In case that signals below 2 control cycle is entered, it may become detected to On if the double High state is maintained.

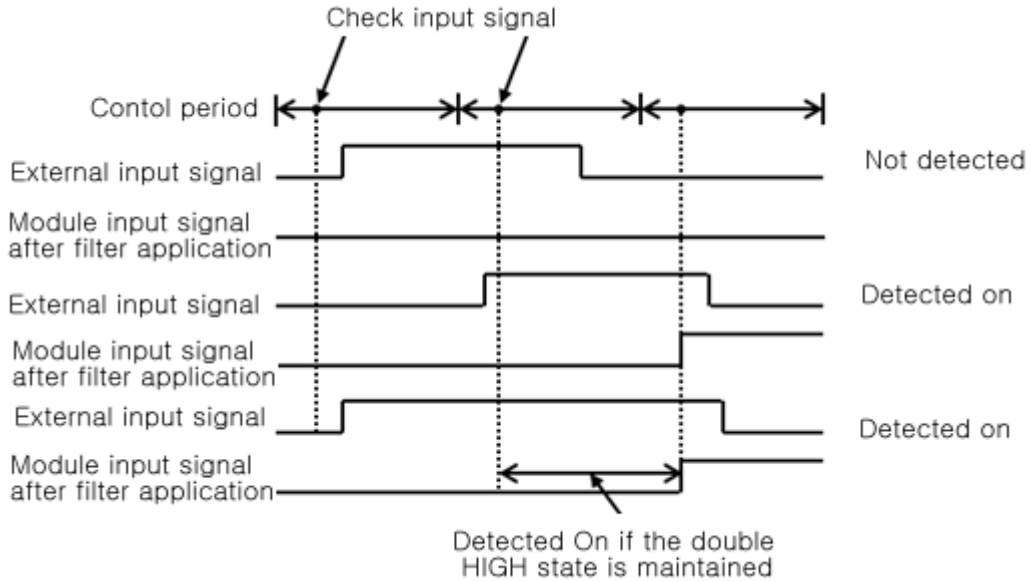

2. Control period depending on the number of axes are as follows.

- 1ms: 1~2axes
- 2ms: 3~5axes
- 3ms: 6~8axes

3. In modules that recognize the range for external input signal as ON/OFF are as follows.

Period	The input filter '0: Disable'		The input filter '1: Enable'	
	Not recognized	Recognizable	Not recognized	Recognizable
1ms	-	Pulse width > 1.05ms	Pulse width < 1.9ms	Pulse width > 2.1ms
2ms	-	Pulse width > 2.1ms	Pulse width < 3.8ms	Pulse width > 4.2ms
3ms	-	Pulse width > 3.15ms	Pulse width < 5.7ms	Pulse width > 6.3ms

4.7 Operation Data

Here describes Operation Data of positioning module.

Can set 400 operation data per each axis, operation of circular interpolation and Linear interpolation act in accordance with information of operation data.

4.7.1 Operation Data

Operation data item		Setting range						
Target position		mm : -2147483648 ~ 2147483647 [$\times 10^{-4}$ mm] Inch : -2147483648 ~ 2147483647 [$\times 10^{-5}$ Inch] degree : -2147483648 ~ 2147483647 [$\times 10^{-5}$ degree] pulse : -2147483648 ~ 2147483647 [pulse]						
Circular interpolation aux. Position								
Operation speed		mm : 1 ~ 2,147,483,647 [$\times 10^{-2}$ mm/min] Inch : 1 ~ 2,147,483,647 [$\times 10^{-3}$ Inch/min] degree : 1 ~ 2,147,483,647 [$\times 10^{-3}$ degree/min] pulse : 1 ~ 2,147,483,647 [pulse/sec]						
Dwell time		0 ~ 65,535[ms]						
M Code no.		0 ~ 65,535						
Setting the sub-axis	Bit unit setting							
	Bit 7	Bit 6	Bit 5	Bit 4	Bit 3	Bit 2	Bit 1	Bit 0
	Axis 8	Axis 7	Axis 6	Axis 5	Axis 4	Axis 3	Axis 2	Axis 1
Helical interpolation axis		0, 1 axis ~ 8 axis (Set'0',normal circular interpolation)						
The number of circular interpolation turns		0~65,535						
Control Word	Coordinate (bit 0)	0:absolute, 1: incremental						
	Control method (bit 1~3)	0:single axis positioning, 1:Speed control reduction, 2:single axis Feed control, 3:linear interpolation, 4:Circular interpolation						
	Operation method (bit 4)	0:Singular, 1:Repeat						
	Operation pattern (bit 5~6)	0:End, 1:Keep, 2: Continuous						
	Circular size (bit 7)	0:Circular arc<180 1: Circular arc >=180						
	Acceleration No. (bit 8~9)	0 ~ 3						
	Deceleration No. (bit 10~11)	0 ~ 3						
	Circular interpolation method (bit 12~13)	0:middle point, 1:central point, 2:radius						
Circular interpolating direction (bit 14)	0:CW, 1:CCW							

Remark

In case of setting unit of each axis as degree, can't operate circular interpolation. Therefore it is idle to set value at the circular interpolating auxiliary position item.

4.7.2 Operation Data Setting

(1) Step No.

- (a) The setting range of positioning data as serial no. is 0 ~ 400.
- (b) The first Starting step of operation data is no.1 step.

Remark

In case of designating step No. is '0' with indirectness maneuver, maneuver at the same time, positioning same period, it means current operation step.

(2) Coordinate

- (a) Coordinate of position data includes absolute coordinate and relative coordinate.

1) Absolute Coordinate (Control by Absolute method)

- a) This carries out the positioning control from the current position to the goal position (the goal position assigned by positioning data).
- b) Control is carried out based on the assigned position of homing (origin address).
- c) Transfer direction shall be determined by the current position and goal position.
 - ▶ Start position < Goal position : forward direction positioning
 - ▶ Start position > Goal position : reverse direction positioning

[Example]

- ▷ When current position : 1000 , Goal position : 8000, forward direction transfer amount is 7000(8000-1000).
- ▷ Software Package Setting

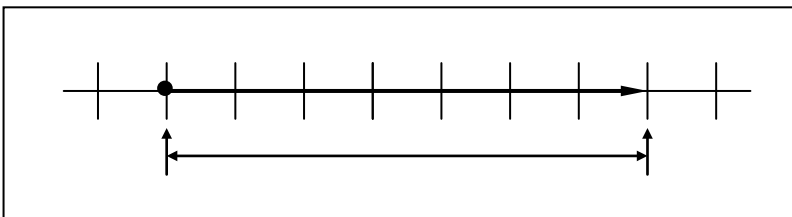

Remark

Control by Absolute method (Absolute coordinate) can start only in the state that the origin is determined. If starting in the state that the origin is not determined, Error will occur.

2) Incremental Coordinate (Control by Incremental method)

- a) This carries out the positioning control as much as goal transfer amount from the current position.
- b) Transfer direction shall be determined by the sign of transfer amount.
 - ▶ When transfer direction is (+) or no sign: forward direction positioning (position increase direction)
 - ▶ When transfer direction is (-): reverse direction positioning (position decrease direction)

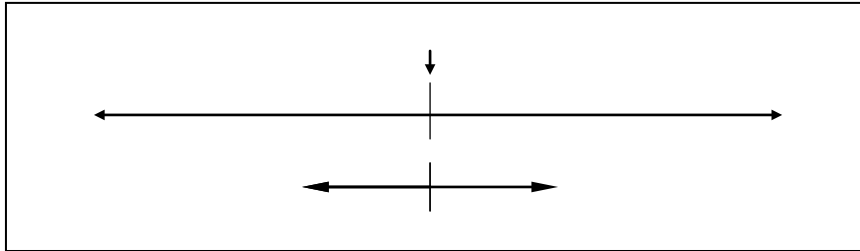

[Example]

- ▷ When current position : 5000 , Goal position : -7000, the positioning shall be done at -2000 position.
- ▷ Software Package Setting

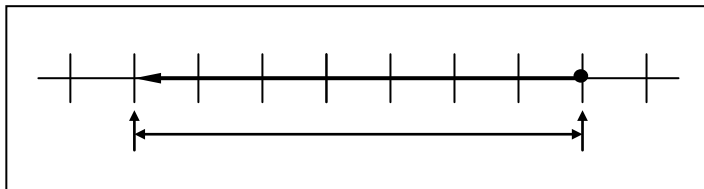

(3) Control Method

- (a) Select the control method: single-axis position control, single-axis Speed control, single-axis Feed control, linear interpolation, circular interpolation.
- (b) For further information, please refer to 9.2 Positioning control of Chapter 9 “Function”.

Remark

Set coordinate and control method in all at the same time in “control method” item with positioning software package. And the software package “Control Method” item is as follows ;
 Absolute, Single-axis Positioning Control / Absolute, Single-axis Speed Control
 /Absolute, Single-axis FEED control / Absolute, linear Interpolation / Absolute, Circular Interpolation
 /Incremental, Single-axis Positioning Control / Incremental, Single-axis Speed Control
 /Incremental, Single-axis FEED control / Incremental, linear Interpolation / Incremental, Circular Interpolation

(4) Operation Pattern (End/Keep/Continuous)

- (a) Operation pattern is setting item, how can step of operation data connect with next step and operate.
- (b) Select one operation pattern from End, Keep, Continuous operation.
- (c) For further information, please refer to 9.2.2 operation mode of positioning control of Chapter 9 "Function".

(5) Operation Method (Single/Repeat)

- (a) Operating Method is an option for selecting an operating step after finish operating step from the driving data setting step.
- (b) In case of setting singular, it will be select next step after finish operating settled step. If you set by Repeat, It will be select settled Repeat step after finish operating settled step.
- (c) Select one positioning operation pattern from Singular, Repeat operation.
- (d) For further information, please refer to 9.2.2 operation mode of positioning control of Chapter 9 "Function".

Remark

Set operation pattern and operation method at the "operation method" item with XG-PM software package. These are "operation method" item; Single,End / Single,Keep / Single,Continuous / Repeat,End / Repeat,Continuous / Repeat,Continuous.

(6) Goal Position

- (a) This is the area to set the transfer amount of position data as "position value".
- (b) The setting range is $-2,147,483,648 \sim 2,147,483,647$ [unit].

(7) M Code

- (a) M code is applied to the whole axis in a bundle by M code mode set by positioning parameter and is given to each operation step no. as a Number within the setting range to use at Program.
- (b) The setting range is $1 \sim 65,535$
- (c) M code no. can be identified by read by the operation state code
- (d) For further information, please refer to M code output of 4.3.2.

(8) Acceleration/Deceleration No.

- (a) The dual acceleration/deceleration time setting is available by setting the acceleration/deceleration time 1/2/3/ 4 of basic parameter as acceleration/deceleration no. 1/2/3/4 respectively.

(9) Operation Speed

- (a) Operation speed is the goal speed which it is applied when it operate positioning
- (b) Operation speed is set within the range that does not exceed Speed limit of basic parameter.

(10) Dwell Time

- (a) This is the waiting time before carrying out the next positioning operation after completing one positioning operation.
- (b) Setting range is 0 ~ 65,535 [ms].
- (c) Especially, in case of using SERVO motor, this is the data to set the waiting time by the stable stop state as positioning module is in the stop state but actual SERVO motor does not reach to the goal position or in transition state.
- (d) While dwell time is active, the corresponding axis of positioning module maintains “ON” of the “in operation state” and if dwell time proceeds, “in operation state” becomes “OFF” and the positioning end signal becomes “ON”.

(11) Sub-Axis setting

- (a) This is an option for sub axis of driving shaft when should operate at least over 2 axis such as linear interpolation or circular interpolation.
- (b) Setting each bit from 1 axis to 8 axis. Each bit is as follows ;

Bit 7	Bit 6	Bit 5	Bit 4	Bit 3	Bit 2	Bit 1	Bit 0
Axis8	Axis7	Axis6	Axis5	Axis 4	Axis 3	Axis 2	Axis 1

- (c) Can choice plural. For example, If you choice axis 2, axis 4 and axis 8 as sub-axis, set “008A” by hexadecimal in sub axis setting.

(12) Circular interpolating auxiliary position

- (a) This is an option for setting auxiliary data when the circular interpolation operates.
- (b) According to circular interpolation, mean of circular interpolating auxiliary position is decided.
It means midpoint which is through by circular arc in midpoint method.
It is central point of circular arc in central point method. And It is radius of circular arc in radius method.
- (c) In case that circular interpolation method is radius, be valid only value of circular interpolating auxiliary position of main axis.
- (d) For further information, please refer to “Circular interpolating control” of 9.2.9 ~ 9.2.11.

(13) Circular interpolating method

- (a) This is an option for method setting from circular interpolating operation.
- (b) There are three method for circular interpolation; midpoint, central point, radius.
- (c) For further information, please refer to "Circular interpolation control" of 9.2.9 ~ 9.2.11.

(14) Circular interpolating direction

- (a) This is an option for setting direction of drawing circle from circular interpolating operation when the operation starts.
- (b) Circular interpolation direction is based on drawing circular interpolation when the main axis is axis 'X' and the sub axis is axis 'Y'.
- (c) This option is ignored from circular interpolation of midpoint because circular interpolating direction is selected by position of midpoint.
- (d) For further information, please refer to circular interpolation of 9.2.9 ~ 9.2.11.

(15) Circular arc size

- (a) When circular interpolating method is set by radius method, User can select one of 2 circular arcs.
- (b) Select one of over the 180-degree circular interpolation or under the 180-degree circular interpolation.
- (c) This option is ignored in the circular interpolation of midpoint method and central point method.
- (d) For further information, please refer to designating radius circular interpolation of 9.2.11

Remark

Positioning software package set as follows at a time; circular arc method, circular interpolating direction, circular arc size with 'Circular interpolating mode'.

Software package 'Circular interpolating mode' is as follows ;

Middle point / Central point, CW / Central point, CCW / Radius, CW, Circular arc < 180-degree / Radius , CW ,
Circular arc >= 180-degree / Radius, CCW, Circular arc < 180-degree / Radius, CCW, Circular arc >= 180-degree

(16) The number of circular interpolating turns

- (a) This is an option setting the number of rotation of circular arc when operating over the 360-degree. (b) Setting range is 1 ~ 65,535.

(17) Helical interpolation axis

- (a) It is item which is setting axis for linear operation in operating helical interpolation.
- (b) Settled axis from helical interpolation rectilinearly operates to settled position at the goal position.
- (c) For further information, please refer to helical interpolating control of 9.2.12.

Chapter 5. Internal Memory and I/O Signal

5.1 Internal Memory

- ▶ Here describes the internal memory used for positioning module if XGK CPU module is used.
- ▶ Internal memory is used when executing direct Data read/write between positioning module and basic unit by using PUP(PUTP), GET(GETP) command instead of using the dedicated command. For Data read/write using the dedicated command, please refer to 6.2 Dedicated Command.

5.1.1 Step Data during Point Start

(1) Memory Address of POINT Start Step Data

Memory address								Contents
1 axis	2 axis	3 axis	4 axis	5 axis	6 axis	7 axis	8 axis	
2A1	321	3A1	421	4A1	521	5A1	621	Point operation step 1
2A2	322	3A2	422	4A2	522	5A2	622	Point operation step 2
2A3	323	3A3	423	4A3	523	5A3	623	Point operation step 3
2A4	324	3A4	424	4A4	524	5A4	624	Point operation step 4
2A5	325	3A5	425	4A5	525	5A5	625	Point operation step 5
2A6	326	3A6	426	4A6	526	5A6	626	Point operation step 6
2A7	327	3A7	427	4A7	527	5A7	627	Point operation step 7
2A8	328	3A8	428	4A8	528	5A8	628	Point operation step 8
2A9	329	3A9	429	4A9	529	5A9	629	Point operation step 9
2AA	32A	3AA	42A	4AA	52A	5AA	62A	Point operation step 10
2AB	32B	3AB	42B	4AB	52B	5AB	62B	Point operation step 11
2AC	32C	3AC	42C	4AC	52C	5AC	62C	Point operation step 12
2AD	32D	3AD	42D	4AD	52D	5AD	62D	Point operation step 13
2AE	32E	3AE	42E	4AE	52E	5AE	62E	Point operation step 14
2AF	32F	3AF	42F	4AF	52F	5AF	62F	Point operation step 15
2B0	330	3B0	430	4B0	530	5B0	630	Point operation step 16
2B1	331	3B1	431	4B1	531	5B1	631	Point operation step 17
2B2	332	3B2	432	4B2	532	5B2	632	Point operation step 18
2B3	333	3B3	433	4B3	533	5B3	633	Point operation step 19
2B4	334	3B4	434	4B4	534	5B4	634	Point operation step 20

(2) POINT Start Step Data Setting

- (a) The POINT start step data setting command for POINT start during POINT operation is XPWR.
- (b) For XPST (command of XGK point operating) and XPWR (command of point operating step data setting), Please refer to the 'Chapter 6.3.43'. (Use XPM_PST function block for XGB-XECU basic unit)
- (c) In PLC program, POINT operation data setting during POINT operation should be done in the step before POINT operation command is executed for normal action of POINT operation.

5.1.2 Teaching Data

(1) Memory Address of Teaching Data

Memory address								Contents
1 axis	2 axis	3 axis	4 axis	5 axis	6 axis	7 axis	8 axis	
280	300	380	400	480	500	580	600	Teaching data1(lower)
281	301	381	401	481	501	581	601	Teaching data1(upper)
282	302	382	402	482	502	582	602	Teaching data2(lower)
283	303	383	403	483	503	583	603	Teaching data2(upper)
284	304	384	404	484	504	584	604	Teaching data3(lower)
285	305	385	405	485	505	585	605	Teaching data3(upper)
286	306	386	406	486	506	586	606	Teaching data4(lower)
287	307	387	407	487	507	587	607	Teaching data4(upper)
288	308	388	408	488	508	588	608	Teaching data5(lower)
289	309	389	409	489	509	589	609	Teaching data5(upper)
28A	30A	38A	40A	48A	50A	58A	60A	Teaching data6(lower)
28B	30B	38B	40B	48B	50B	58B	60B	Teaching data6(upper)
28C	30C	38C	40C	48C	50C	58C	60C	Teaching data7(lower)
28D	30D	38D	40D	48D	50D	58D	60D	Teaching data7(upper)
28E	30E	38E	40E	48E	50E	58E	60E	Teaching data8(lower)
28F	30F	38F	40F	48F	50F	58F	60F	Teaching data8(upper)
290	310	390	410	490	510	590	610	Teaching data9(lower)
291	311	391	411	491	511	591	611	Teaching data9(upper)
292	312	392	412	492	512	592	612	Teaching data10(lower)
293	313	393	413	493	513	593	613	Teaching data10(upper)
294	314	394	414	494	514	594	614	Teaching data11(lower)
295	315	395	415	495	515	595	615	Teaching data11(upper)
296	316	396	416	496	516	596	616	Teaching data12(lower)
297	317	397	417	497	517	597	617	Teaching data12(upper)
298	318	398	418	498	518	598	618	Teaching data13(lower)
299	319	399	419	499	519	599	619	Teaching data13(upper)
29A	31A	39A	41A	49A	51A	59A	61A	Teaching data14(lower)
29B	31B	39B	41B	49B	51B	59B	61B	Teaching data14(upper)
29C	31C	39C	41C	49C	51C	59C	61C	Teaching data15(lower)
29D	31D	39D	41D	49D	51D	59D	61D	Teaching data15(upper)
29E	31E	39E	41E	49E	51E	59E	61E	Teaching data16(lower)
29F	31F	39F	41F	49F	51F	59F	61F	Teaching data16(upper)

(2) Setting

- (a) The command of Teaching data setting is XTWR.
- (b) For XTEAA (command of XGK Teaching) and XTWR (command of Teaching Data Setting), Please refer to the 'Chapter 6.3.30'. (Use XPM_ATEA function block for XGB-XECU basic unit)
- (c) In PLC program, in order to carry out the normal action of Teaching command, the Teaching data setting should be done in the step before Teaching command is executed.

5.1.3 Step Data of Simultaneous Start

(1) Step Data of Simultaneous Start Memory Address

Memory address								Contents
1 axis	2 axis	3 axis	4 axis	5 axis	6 axis	7 axis	8 axis	
2B6	336	3B6	436	4B6	536	5B6	636	Simultaneous start 1 axis step number
2B7	337	3B7	437	4B7	537	5B7	637	Simultaneous start 2 axis step number
2B8	338	3B8	438	4B8	538	5B8	638	Simultaneous start 3 axis step number
2B9	339	3B9	439	4B9	539	5B9	639	Simultaneous start 4 axis step number
2BA	33A	3BA	43A	4BA	53A	5BA	63A	Simultaneous start 5 axis step number
2BB	33B	3BB	43B	4BB	53B	5BB	63B	Simultaneous start 6 axis step number
2BC	33C	3BC	43C	4BC	53C	5BC	63C	Simultaneous start 7 axis step number
2BD	33D	3BD	43D	4BD	53D	5BD	63D	Simultaneous start 8 axis step number

(2) Setting

- (a) The command for Step Data of Simultaneous Start setting is XSWR.
- (b) For XSST (command of XGK Simultaneous Start) and XSWR (Setting command for Step Data of Simultaneous Start), Please refer to the 'Chapter 6.3.6'. (Use XPM_SST function block for XGB-XECU basic unit)
- (c) In PLC program, in order to carry out the normal action of Simultaneous Start, the Step data setting of Simultaneous Start should be done in the step before Simultaneous Start command is executed.

5.1.4 State Information

(1) Memory Address of State Information

XSRD device offset	Memory address								Content
	1 axis	2 axis	3 axis	4 axis	5 axis	6 axis	7 axis	8 axis	
0	2C0	340	3C0	440	4C0	540	5C0	640	Operation state bit information (Lower)
1	2C1	341	3C1	441	4C1	541	5C1	641	Operation state bit information (Upper)
2	2C2	342	3C2	442	4C2	542	5C2	642	Axis information
3	2C3	343	3C3	443	4C3	543	5C3	643	External I/O signal state
4	2C4	344	3C4	444	4C4	544	5C4	644	Current Position (lower)
5	2C5	345	3C5	445	4C5	545	5C5	645	Current Position (upper)
6	2C6	346	3C6	446	4C6	546	5C6	646	Current Speed (lower) ^{*2}
7	2C7	347	3C7	447	4C7	547	5C7	647	Current Speed (upper) ^{*2}
8	2C8	348	3C8	448	4C8	548	5C8	648	Step Number
9	2C9	349	3C9	449	4C9	549	5C9	649	M Code
10	2CA	34A	3CA	44A	4CA	54A	5CA	64A	Error information
11	2CB	34B	3CB	44B	4CB	54B	5CB	64B	Error information 1
12	2CC	34C	3CC	44C	4CC	54C	5CC	64C	Error information 2
13	2CD	34D	3CD	44D	4CD	54D	5CD	64D	Error information 3
14	2CE	34E	3CE	44E	4CE	54E	5CE	64E	Error information 4
15	2CF	34F	3CF	44F	4CF	54F	5CF	64F	Error information 5
16	2D0	350	3D0	450	4D0	550	5D0	650	Error information 6
17	2D1	351	3D1	451	4D1	551	5D1	651	Error information 7
18	2D2	352	3D2	452	4D2	552	5D2	652	External input signal (lower) ^{*1}
19	2D3	353	3D3	453	4D3	553	5D3	653	External input signal (upper) ^{*1}
20	2D4	354	3D4	454	4D4	554	5D4	654	Servo error information
21	2D5	355	3D5	455	4D5	555	5D5	655	Encoder1 value (lower)
22	2D6	356	3D6	456	4D6	556	5D6	656	Encoder1 value (upper)
23	2D7	357	3D7	457	4D7	557	5D7	657	-
24	2D8	358	3D8	458	4D8	558	5D8	658	-
25	2D9	359	3D9	459	4D9	559	5D9	659	Command position (lower)
26	2DA	35A	3DA	45A	4DA	55A	5DA	65A	Command position (upper)
27	2DB	35B	3DB	45B	4DB	55B	5DB	65B	Command speed (lower)
28	2DC	35C	3DC	45C	4DC	55C	5DC	65C	Command speed (upper)
29	2DD	35D	3DD	45D	4DD	55D	5DD	65D	Torque
30	2DE	35E	3DE	45E	4DE	55E	5DE	65E	Common error information

^{*1} : External input signal

- It display the status information of digital input(0x60FD Object) of servo drive.
- In order to use this information, please use after checking availability at XG-PM [Network parameter →servo information → servo setting information → input signal information]. (Servo drives that are registered in XG-PM has been checked by basically use)
- For more information about external input signal, please refer to the servo drive user's manual.

- External input signal is composed of a 32bit, lower 16bit is displayed at external input signal (lower) and upper 16bit is displayed at external input signal(upper).
- In case of L7NH drive, it contains the following information.

Bit	Input	Details
0	N-OT: The reverse limit switch	0: Off 1: On
1	P-OT: The forward limit switch	0: Off 1: On
2	Home switch	0: Off 1: On
3 to 15	Reserved	
16	DI #1(I/O pin 11)	0: Switch Off (Open), 1: Switch On (Close)
17	DI #2(I/O pin 12)	0: Switch Off (Open), 1: Switch On (Close)
18	DI #3(I/O pin 7)	0: Switch Off (Open), 1: Switch On (Close)
19	DI #4(I/O pin 8)	0: Switch Off (Open), 1: Switch On (Close)
20	DI #5(I/O pin 13)	0: Switch Off (Open), 1: Switch On (Close)
21	DI #6(I/O pin 14)	0: Switch Off (Open), 1: Switch On (Close)
22	DI #7(I/O pin 9)	0: Switch Off (Open), 1: Switch On (Close)
23	DI #8(I/O pin 10)	0: Switch Off (Open), 1: Switch On (Close)
24~30	Reserved	
31	STO(Safe Torque Off)	

*2 : Current speed

- If the command speed is driving at a speed of less than 1pulse for each control period, the actual current speed can display more than command speed.

Ex) In case of command speed 200 pls/s operation

Control period is 2ms and position movement amount per control period is 0.4pulse(=200*2/1000).

When the movement amount is more than 1pulse, 1pulse is moved, and actual current speed is displayed in 500pls/s(=1pls/2ms)

(2) Setting

- The area of state information of internal memory is the Read only area. So, when you use XGB-XBCU basic unit, it is available to use only by GET, GETP command. (PUT, PUTP command is not allowed to use in this area).
- The command of State Information ready only is XSRD. (Refer to 6.3.42)
- If you use only command XSRD, the information of axis status is read at the same time. (Use XPM_SRD function block for XGB-XECU basic unit)
- If you want to choose to read among the state information, it is available to read memory address of above table using by GET/GETP

(e) Use of State Information

1) Operation State Bit Information (Lower)

Memory address								Information
1 axis	2 axis	3 axis	4 axis	5 axis	6 axis	7 axis	8 axis	
2C0	340	3C0	440	4C0	540	5C0	640	Operation State bit Information (LOWER)

Bit 0	In Operation	[0: Stop, 1: In Operation]
Bit 1	Error State	[0: No Error, 1: Errors]
Bit 2	Positioning Completed	[0: Positioning not completed, 1: Positioning completed]
Bit 3	M Code Signal	[0: M Code Off, 1: M Code On]
Bit 4	Homing State	[0: Homing not completed, 1: Homing completed]
Bit 5	Common error state	[0: No common error, 1: common error occurred]
Bit 6	Stop State	[0: Stop State not by Stop Command, 1: Stop State by Stop Command]
Bit 7	Now reading/writing variable data	[0: reading/writing variable data completed, 1: now reading writing]
Bit 8	Upper limit detection	[0: No Detection, 1: Detection]
Bit 9	Lower limit detection	[0: No Detection, 1: Detection]
Bit 10	Emergency Stop State	[0: Normal, 1: Emergency Stop]
Bit 11	Forward/Reverse	[0: Forward, 1: Reverse]
Bit 12	Acceleration State	[0: No Accelerating, 1: Accelerating]
Bit 13	Constant Speed State	[0: Not Under Constant, 1: Under Constant]
Bit 14	Deceleration State	[0: No Decelerating, 1: Decelerating]
Bit 15	Dwell State	[0: No Dwelling, 1: Dwelling]

2) Operation State Bit Information (Upper)

Memory address								Information
1 axis	2 axis	3 axis	4 axis	5 axis	6 axis	7 axis	8 axis	
2C1	341	3C1	441	4C1	541	5C1	641	Operation State Bit Information (UPPER)

Bit 0	Axis 1 Position Controlling	[0: Axis 1 Position not in control, 1: Axis 1 Position in control]
Bit 1	Axis1 Speed Controlling	[0: Axis 1 Speed not in control, 1: Axis 1 Speed in control]
Bit 2	Linear Interpolation in Operation	[0: Linear Interpolation not in Operation, 1: Linear Interpolation in Operation]
Bit 3	Torque control in operation	[0: Torque control not in operation, 1: Torque control in operation]
Bit 4	Circular Interpolation in Operation	[0: Circular Interpolation not in Operation, 1: Circular Interpolation in Operation]
Bit 5	Homing Operating	[0: Homing not in Operation, 1: Homing in Operation]
Bit 6	Synchronous Start by Position in Operation	[0: Synchronous Start by position not in Operation, 1: Synchronous Start by position in Operation]
Bit 7	Synchronous Start by Speed in Operation	[0: Synchronous Start by Speed not in Operation, 1: Synchronous Start by Speed in Operation]
Bit 8	JOG in Operation	[0: JOG not in Operation, 1: JOG in Operation]
Bit 9	Phase correction in Operation	[0: Phase correction not in Operation, 1: Phase correction in Operation]
Bit 10	Inching in Operation	[0: Inching not in Operation, 1: Inching in Operation]
Bit 11	No Use	[0]
Bit 12	RTP ^{*1} in Operation	[0: RTP not in Operation, 1: RTP in Operation]
Bit 13	CAM in Operation	[0: CAM not in Operation, 1: CAM in Operation]
Bit 14	FEED in Operation	[0: FEED not in Operation, 1: FEED in Operation]
Bit 15	Circular Interpolation in Operation	[0: Circular Interpolation not in Operation, 1: Circular Interpolation in Operation]

Remark

*1

RTP: Return to Position Before Manual Operation

3) Axis Information(bit)

Memory Address								Information
1 axis	2 axis	3 axis	4 axis	5 axis	6 axis	7 axis	8 axis	
2C2	342	3C2	442	4C2	542	5C2	642	Axis information

Bit 0	Main axis information	[1 ~ 8: 1 ~ 8 Axis 9: Encoder1 10: Encoder2]
Bit 1		
Bit 2		
Bit 3		
Bit 4	Axis status	[0: Sub-axis, 1: Main-axis]
Bit 5	Trigger Completed ^{*3}	
Bit 6	Latch Completed ^{*1}	[0: Not completed, 1: Completed]
Bit 7	Not writing to servo driver EEPROM	
Bit 8	Not used	[0]
~		
Bit 12		
Bit 13	CAM1 cycle completed status signal	
Bit 14	Now writing to module Flash memory	[0: Not writing, 1: Writing]
Bit 15	Speed synchronizing ^{*2}	[0: Not synchronizing, 1: Synchronizing]

*1: Information of Latch Completed

*2: Speed synchronizing bit can be used in only XGEARIP, XPM_GEARIP.

*3: Information of Trigger Completed. This will be on when all latch, which set by trigger, has completed.

4) External I/O Signal State

Memory Address								Information
1 axis	2 axis	3 axis	4 axis	5 axis	6 axis	7 axis	8 axis	
2C3	343	3C3	443	4C3	543	5C3	643	External I/O signal state

Bit 0	External EMG Stop	[0: External EMG stop Off, 1: External EMG stop On]
Bit 1	Not used	[0]
Bit 2		
Bit 3		
Bit 4		
Bit 5	External lower limit signal	[0: External lower limit signal Off, 1: External lower limit signal On]
Bit 6	Home signal ^{*2}	[0: Home signal Off, 1: Home signal On]
Bit 7	DOG signal	[0: DOG signal Off, 1: DOG signal On]
Bit 8	External ^{*1} command signal	[0: External command signal Off, 1: External command signal On]
Bit 9	Servo On signal	[0: Servo Off, 1: Servo On]
Bit 10	Servo alarm signal	[0: Servo driver normal, 1: Servo driver error occurs]
Bit 11	In-position signal	[0: Not In-position section, 1: In-position section]
Bit 12	External input signal A	[0: External input signal A Off, 1: External input signal A ON]
Bit 13	External input signal B	[0: External input signal B Off, 1: External input signal B ON]
Bit 14	External input signal Z	[0: External input signal Z Off, 1: External input signal Z ON]
Bit 15	Communication error	[0: EtherCAT Comm. normal, 1: EtherCAT Comm. error]

Remark
<p>*1 External command signal: It acts as one between “External speed/position control switching” , “External dec, stop” and “External Latch” according to “External command signal” setting in the extended parameter. D1#1 is used as external command signal only when LS MECAPION L7N servo drive is used.</p> <p>*2 Home Signal: the servo drive’s HOME input signal is mapped to the home signal.</p>

5.1.5 User define position, User define speed information

(1) Memory address and description

GET command Device offset	Memory address								Description
	1 Axis	2 Axis	3 Axis	4 Axis	5 Axis	6 Axis	7 Axis	8 Axis	
0	B8	F8	138	178	1B8	1F8	238	278	Current user define position (lower)
1	B9	F9	139	179	1B9	1F9	239	279	Current user define position (higher)
2	BA	FA	13A	17A	1BA	1FA	23A	27A	Current user define position (lower)
3	BB	FB	13B	17B	1BB	1FB	23B	27B	Current user define position (higher)
4	BC	FC	13C	17C	1BC	1FC	23C	27C	Current user define position (lower)
5	BD	FD	13D	17D	1BD	1FD	23D	27D	Current user define position (higher)
6	BE	FE	13E	17E	1BE	1FE	23E	27E	Current user define position (lower)
7	BF	FF	13F	17F	1BF	1FF	23F	27F	Current user define position (higher)

(2) Setting

- (a) User define position of the internal memory is read only area. Therefore read command(GET/GETP) for XGK CPU is available, and the Write command(PUT/PUTP) is not available.
- (b) Choose if user wants to read the contents of the state information then, use GET/GETP command and if user read any of the location of the memory address.

5.2 I/O Signal

Here describes the contents and functions of I/O signal for the exchange of data between Positioning module and XGB-XBCU basic unit.

5.2.1 Contents of I/O Signal

- (1) I/O signal of positioning module uses input: 16 bits and output: 32 bits.
- (2) Positioning Module operation ready signal (Uxx.00.F) becomes "ON" only when Modules are in normal state in H/W and it always keeps "ON" regardless of PLC operation mode.
- (3) For operation ready signal, if positioning module and servo driver are connected through EtherCAT communication, applicable bit of the connected axis will be on regardless of the operation mode of the PLC.
- (4) Output Signal

This is the signal which transfers to positioning module from basic unit.

Signal Direction: Basic unit → Positioning Module					
Axis	Output signal	Contents	Axis	Output signal	Contents
1 axis	Uxx.01.0	1 axis forward direction JOG	5 axis	Uxx.02.0	5 axis forward direction JOG
	Uxx.01.1	1 axis reverse direction JOG		Uxx.02.1	5 axis reverse direction JOG
	Uxx.01.2	1 axis JOG low/high speed		Uxx.02.2	5 axis JOG low/high speed
	Uxx.01.3	Not used		Uxx.02.3	Not used
2 axis	Uxx.01.4	2 axis forward direction JOG	6 axis	Uxx.02.4	6 axis forward direction JOG
	Uxx.01.5	2 axis reverse direction JOG		Uxx.02.5	6 axis reverse direction JOG
	Uxx.01.6	2 axis JOG low/high speed		Uxx.02.6	6 axis JOG low/high speed
	Uxx.01.7	Not used		Uxx.02.7	Not used
3 axis	Uxx.01.8	3 axis forward direction JOG	7 axis	Uxx.02.8	7 axis forward direction JOG
	Uxx.01.9	3 axis reverse direction JOG		Uxx.02.9	7 axis reverse direction JOG
	Uxx.01.A	3 axis JOG low/high speed		Uxx.02.A	7 axis JOG low/high speed
	Uxx.01.B	Not used		Uxx.02.B	Not used
4 axis	Uxx.01.C	4 axis forward direction JOG	8 axis	Uxx.02.C	8 axis forward direction JOG
	Uxx.01.D	4 axis reverse direction JOG		Uxx.02.D	8 axis reverse direction JOG
	Uxx.01.E	4 axis JOG low/high speed		Uxx.02.E	8 axis JOG low/high speed
	Uxx.01.F	Not used		Uxx.02.F	Not used

(5) Input Signal

This is the Signal which transfers to basic unit from Positioning Module.

Axis	Signal direction: Basic unit ← Positioning module	
	Input signal	Contents
1 axis	Uxx.00.0	1 axis operation ready
2 axis	Uxx.00.1	2 axis operation ready
3 axis	Uxx.00.2	3 axis operation ready
4 axis	Uxx.00.3	4 axis operation ready
5 axis	Uxx.00.4	5 axis operation ready
6 axis	Uxx.00.5	6 axis operation ready
7 axis	Uxx.00.6	7 axis operation ready
8 axis	Uxx.00.7	8 axis operation ready
-	Uxx.00.8	Not used
-	Uxx.00.9	Not used
-	Uxx.00.A	Not used
-	Uxx.00.B	Not used
-	Uxx.00.C	Not used
-	Uxx.00.D	Not used
Common	Uxx.00.E	Link up/down information
Common	UXX.00.F	Positioning module operation ready

5.2.2 Use of I/O Signal

(1) Axis operation ready signal

- (a) For operation ready signal, if positioning module and servo driver are connected through EtherCAT communication, applicable bit of the connected axis will be on regardless of the operation mode of the PLC.
- (b) EtherCAT communication connection is done through the instruction "XECON" or function block "XPM_DCON".
- (c) When you disconnection the communication between the positioning module and servo driver by using instruction "XDCON" or function block "XPM_DCON", operation ready signal of all axes turn off.
- (d) When giving the command to axis, check whether axis operation ready signal is on or not.
- (e) For "Uxx.00.zz", U means PLC CPU's U device, xx means the location of the positioning module, zz means the bit of the input signal.

(2) Link up/down information

- (a) Link up/down information is on when network cable is connected to the positioning module physically. And if the cable is disconnected, then it will be off.
- (b) If you use it as execution condition contact point of servo connection command (XECON, XPM_ECON), when a network cable is not connected, servo connection command will not be executed and when a network cable is connected, servo connection command will be executed. Then you can prevent the unnecessary error.

(3) JOG Operation

(a) Forward/Reverse Jog Signals show the direction of Jog Operation. The Jog operation shall be divided into Forward/Reverse direction according to the On/Off signals. When Forward Jog Signal is On, it starts Forward Operation and When Jog Signal is Off, it starts Reverse Operation. When both signals Off, it stops Jog Signals. When both signals On, it does Forward Jog Signal.

Forward Jog Signal	Reverse Jog Signal	Jog Operation Status
On	Off	Forward Jog Operation
Off	On	Reverse Jog Operation
Off	Off	Stop
On	On	Forward Jog Operation

(b) If Jog direction is changed during Jog operation, it slows down at first and then operates as the direction it changed.

(c) According to value of Jog low/high Signals, it could operate with low/high speed. When jog low/high signals Off, it operates with low speed and when they are ON, it operates with high speed.

(d) If you change value of low/high jog signals during Jog operation, there will be no stop and apply the speed as you changed.

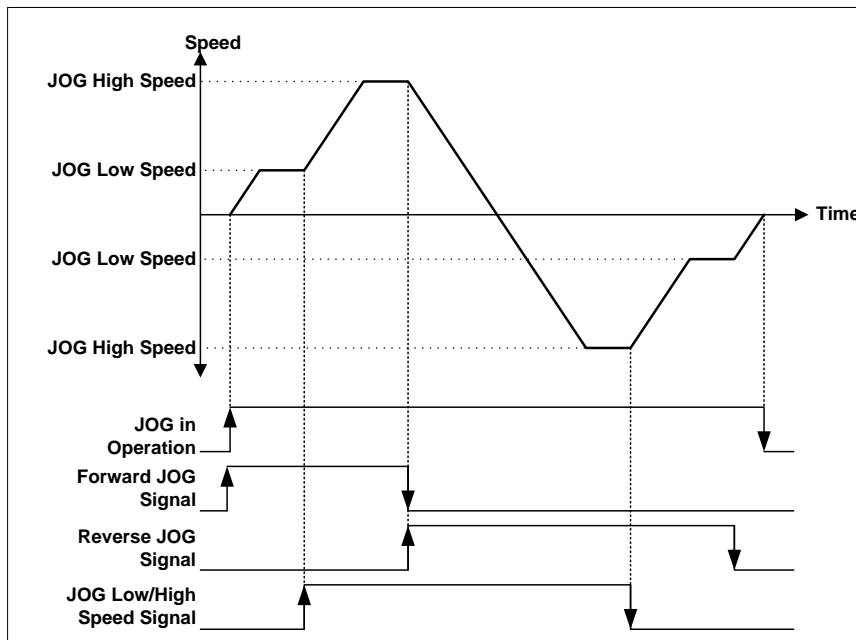

Chapter6 Command

Here describes the positioning command used in basic unit of XGB-XBCU

6.1 Contents of General Command

Command	Command description	Command condition
PUT	Internal memory write (Level)	Base, memory address, save device leading address, data number to write at one time
PUTP	Internal memory write (Edge)	Base, memory address, save device leading address, data number to write at one time
GET	Internal memory read (Level)	Base, memory address, save device leading address, data number to write at one time
GETP	Internal memory read (Edge)	Base, memory address, save device leading address, data number to write at one time

6.1.1 Internal Memory Read (GET, GETP Command)



Form	Description	Available area
n1	Base and slot No. installed with special module	Constant
n2	Leading address of special module internal memory to read a data	Constant
D	Leading address of device to save the data to read	M, P, K, L, U, N, D,
n3	Word number of data to read	M, P, K, L, Constant

(1) Difference between GET Command and GETP Command

(a) GET Command

Always execute when operating condition is ON. (Level)
That is, when execute condition is ON, it operates continuously.

(b) GETP Command

Execute with operation start of execute condition. (Edge)
That is, when execute condition is ON, it operates only one time.
To operate again, execute condition should be off and on again.

Example The case is that read current position, current speed and step number from axis 4 state information of positioning module which installed in No.0 base, No.2 slot to PLC CPU M0000. Set the number of data as 5 to read 5 Word from current position to step number.

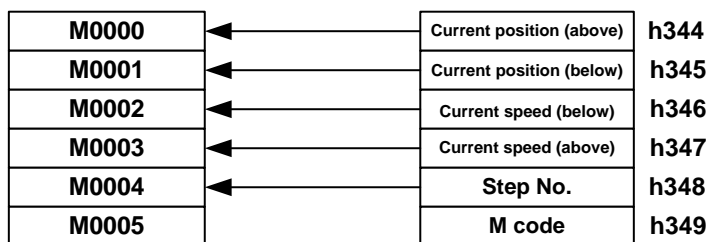

6.1.2 Internal Memory Write (PUT, PUTP Command)



For	Description	Available area
n1	Base and slot No. installed with special module	Constant
n2	Leading address of special module internal memory to write	Constant
S	Leading address of device that the data to Write is saved	M, P, K, L, U, N, D, R
n3	Word number of data to write	M, P, K, L, Constant

(1) Difference between GET Command and GETP Command

(a) PUT Command

Always execute when operating condition is ON. (Level)
That is, when execute condition is ON, it operates continuously.

(b) PUTP Command

Execute with operation start of execute condition. (Edge)
That is, when execute condition is ON, it operates only one time.
To operate again, execute condition should be off and on again.

Example

The case that is installed in positioning module No.0 base, slot No.1 and writes value of CPU module as axis 3 teaching value by 16 Word data of D00000~D00015.

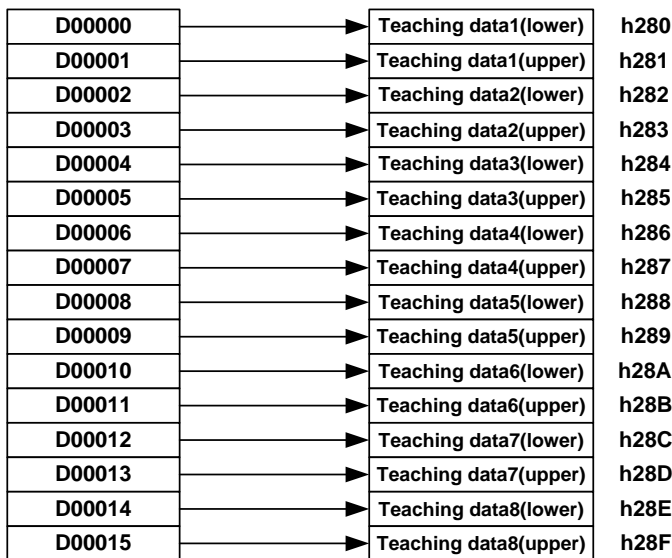

6.2 Dedicated Commands

6.2.1 Command List

Command	Command description	Command condition	Notes
XORG	Homing start	Slot, command axis	6.3.1
XFLT	Floating origin setting	Slot, command axis	6.3.2
XDST	Direct start	Slot, command axis, position, speed, dwell time, M code, control word	6.3.3
XIST	Indirect start	Slot, command axis, step no.	6.3.4
XSST	Simultaneous start	Slot, command axis, Simultaneous start axis	6.3.5
XSWR	Simultaneous start step setting	Slot, command axis, step no., device, number of steps	6.3.6
XELIN	Ellipse interpolation	Slot, command axis, ratio of the ellipse, driving angle	6.3.7
XVTP	Speed/position switching control	Slot, command axis	6.3.8
XVTPP	Position specified speed/position switching control	Slot, command axis, target position	6.3.9
XPTV	Position/speed switching control	Slot, command axis	6.3.10
XPTT	Position/torque switching control	Slot, command axis, torque value	6.3.11
XSTP	Deceleration stop	Slot, command axis, deceleration time	6.3.12
XSKP	Skip operation	Slot, command axis	6.3.13
XSSP	Position synchronous start	Slot, command axis, step no., main axis position, main axis setting	6.3.14
XSSS	Speed synchronous start	Slot, command axis, main axis rate, subordinate axis rate, main axis setting	6.3.15
XSSSP	Position assigned Speed synchronous start	Slot, command axis, main axis rate, subordinate axis rate, main axis setting, goal position	6.3.16
XCAM	CAM Operation	Slot, command axis, main axis setting, CAM block no.	6.3.17
XCAMO	Main axis offset-specified CAM operation	Slot, command axis, main axis setting, CAM block no., main axis offset	6.3.18
XPOR	Position override	Slot, command axis, position	6.3.19
XSOR	Speed override	Slot, command axis, speed	6.3.20
XPSO	Position assigned speed override	Slot, command axis, position, speed	6.3.21
XNMV	Continuous operation	Slot, command axis	6.3.22
XINCH	Inching operation	Slot, command axis, inching amount	6.3.23
XRTP	Return to the position before manual operation	Slot, command axis	6.3.24
XSNS	Start step No. change	Slot, command axis, step no.	6.3.25
XRSR	Repeat step No. change	Slot, command axis, step no.	6.3.26
XMOF	M code release	Slot, command axis	6.3.27
XPRS	Current position preset	Slot, command axis, position	6.3.28
XEPRS	Encoder preset	Slot, position, Encoder no.	6.3.29
XTEAA	Teaching Array	Slot, command axis, step no., RAM/ROM, position/speed, Teaching no.	6.3.30
XTWR	Teaching array data setting	Slot, command axis, teaching data device, no. of teaching	6.3.31

Command	Command description	Command condition	Notes
XSBP	Basic parameter teaching	Slot, command axis, basic parameter change value, item to change, RAM/ROM	6.3.32
XSEP	Extended parameter setting	Slot, command axis, extended parameter change value, item to change, RAM/ROM	6.3.33
XSMP	Manual operation parameter setting	Slot, command axis, manual operation parameter change value, item to change, RAM/ROM	6.3.34
XSES	Parameter setting of input/output signal	Slot, command axis, parameter changing value of input/output signal, RAM/ROM	6.3.35
XSEST	Switching torque of external position/torque control	Slot, command axis, torque value, RAM/ROM	6.3.36
XSCP	Common parameter setting	Slot, command axis, common parameter change value, item to change, RAM/ROM	6.3.37
XSMD	Operation data teaching	Slot, command axis, operation data value, operation data item, step no., RAM/ROM	6.3.38
XVRD	Variable data reading	Slot, command axis, read address, block offset, block size, block count	6.3.39
XVWR	Variable data writing	Slot, command axis, data device, write address, block offset, block size, block count	6.3.40
XWRT	Parameter/operation data save	Slot, command axis, axis information	6.3.41
XEMG	Emergency stop	Slot, command axis	6.3.42
XCLR	Error reset	Slot, command axis, common error reset	6.3.43
XECLR	Error history reset	Slot, command axis	6.3.44
XPST	Point Start	Slot, command axis, step no.	6.3.45
XPWR	Point start step data setting	Slot, command axis, step data device, step no.	6.3.46
XSRD	Operation state reading	Slot, command axis, operation state save, device no.	6.3.47
XECON	Servo connection	Slot, command axis	6.3.48
XDCON	Servo disconnection	Slot, command axis	6.3.49
XSVON	Servo On	Slot, command axis	6.3.50
XSVOFF	Servo Off	Slot, command axis	6.3.51
XSCLR	Servo error reset	Slot, command axis	6.3.52
XSECLR	Servo error history reset	Slot command axis	6.3.53
XRSTR	Restart	Slot, command axis	6.3.54
XSVPRD [*]	Servo parameter read	Slot, command axis, Index, Sub-Index, data size	6.3.55
XVWPWR [*]	Servo parameter write	Slot, command axis, Index, Sub-Index, data size, data, RAM/ROM	6.3.56
XSVSAVE [*]	Servo parameter save	Slot, command axis, saving axis	6.3.57
XTRQ	Torque control	Slot, command axis, torque value, gradient	6.3.58
XLRD	Latch position data read	Slot, command axis, device number	6.3.59
XLCLR	Latch reset	Slot, command axis, latch reset item	6.3.60
XLSET [*]	Latch setting	Slot, command axis, latch enable/disable, latch mode	6.3.61
XSTC	Torque synchronous	Slot, command axis, Main axis torque ratio, Sub axis torque ratio, Main axis speed ratio(Unused), Sub axis speed ratio(Unused), Set main axis(1~8 : 1axis ~ 8axis)	6.3.62

Command	Command description	Command condition	Notes
XPHASING	Phasing Correction	Slot, command axis, Phasing Correction Value, Phasing Correcting speed, Acceleration time, Deceleration time, Command axis	6.3.63
XSSSD	32bit Speed synchronous	Slot, command axis, Speed sync. main axis ratio, Speed sync. sub axis ratio, Main axis	6.3.64
XSSSPD	32bit Speed synchronous	Slot, command axis, Speed sync. main axis ratio, Speed sync. sub axis ratio, Main axis	6.3.65
XSETOVR	Speed Acceleration / Deceleration override	Slot, command axis, Speed, Main axis, Acceleration, Deceleration, S-curve, Direction of drive	6.3.66
XCAMA	Absolute positioning CAM Operation	Slot, command axis, main axis, CAM block info, synchronize start position	6.3.67
XTPROBE	Touch Probe	Slot, command axis, Trigger Signal, Trigger Mode, Windowed mode, Start position allowing window mode, End position allowing window mode	6.3.68
XABORTT	Abort Trigger	Slot, command axis, Trigger Signal, Trigger Reset Time	6.3.69
XTRQSL	Torqur control Mode Speed Limits	Slot, command axis, Trigger Signal, Torque Value, Slop, Speed LimitValue	6.3.70
XGEARIP	Synchronous speed designating synchronous position	Slot, command axis, Synchronization rate, Synchronous position for the main axis, Synchronous position for the sub axis, Synchronous start position for the major axis, Control word	6.3.71

6.2.2 Cautions Of Using Command

Remark

- The dedicated command acts at Rising edge. That is, it executed the first action once when input condition is "ON." To execute the action again, It should be "OFF" and then "ON" again. SRD just execute High level action. When input condition is "On," it keeps operating and it doesn't operate when it's "Off."
- Command execution time is as below.
 - XWRT : 15ms (per axis1)
 - Commands except XWRT :
2ms (when using 3 axes) ~ 4ms (when using 8 axes)
- Don't use XVRD and XVWR command at the same time. That is, you must execute a command after the other command's operation completes. Please note that the command don't execute at the same time in case the command axis is same or different.

Remark

- This is the method used with the operation state bit(in operation, error state) read by using XSRD as the program operation condition

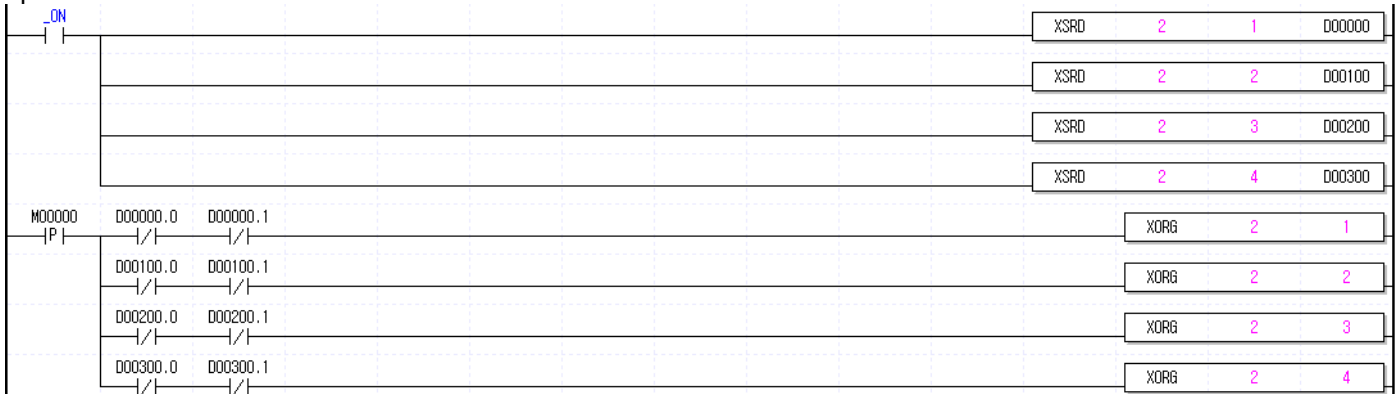

- ※ D00000.0: 1 axis in operation, D00000.1: 1 axis error state
 D00100.0: 2 axis in operation, D00100.1: 2 axis error state
 D00200.0: 3 axis in operation, D00200.1: 3 axis error state
 D00300.0: 4 axis in operation, D00300.1: 4 axis error state

- The example program for command in this Chapter 8 also uses the operation state bit as the program operation condition as the above.

Remark

► All dedicated commands except XSRD, XPWR, XTWR, XSWR, XLRD are not allowed to use together for one command execution axis. If it is used like the below example program, a command does not work properly.

If executing other command

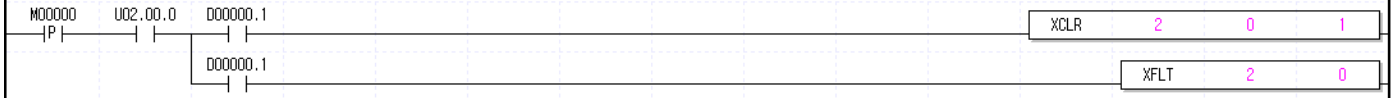

If executing same command

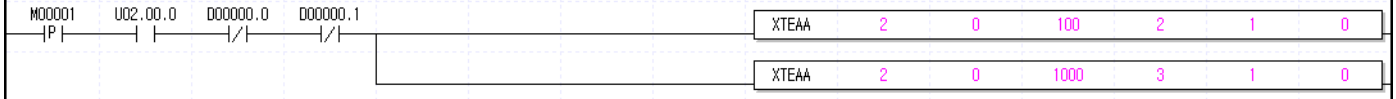

► A same command can be executed for other axis.

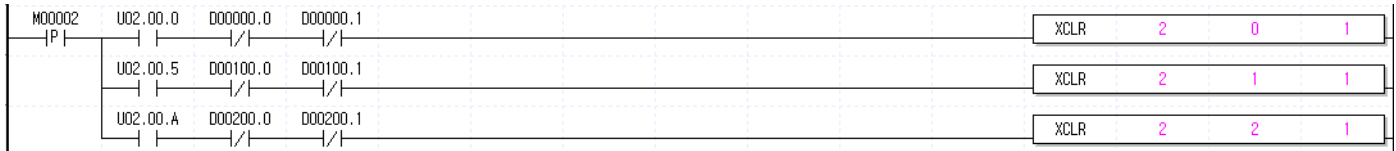

6.3 Use of Dedicated Command

Here describes the command usage based on 1 axis when the positioning module is inserted into slot 2. The position and speed use the units of pulse and pulse/sec [pps], respectively.

6.3.1 Homing start (Command : XORG)

(1) Program

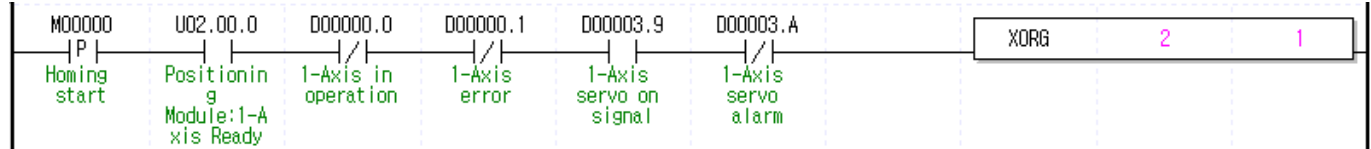

(2) Description

Device	Description
M00000	axis1 homing start input
U02.00.0	axis1 ready
D00000.0	axis1 operation
D00000.1	axis1 error
D00003.9	axis1 servo on signal
D00003.A	axis1 servo error

Command	XORG				Homing start
Operand	OP1	Slot	Constant	WORD	Slot No. installed with positioning module
	OP2	Axis	PMLK, constant, D, Z, R, ZR	WORD	Command axis XBF-PN04B: 1axis~4axis XBF-PN08B:1axis~8axis

※ PMLK means P, M, L and K areas.

- If homing start command is executed, it carries out homing operation by the setting homing parameter and if homing is complete by external input signal, the origin determination end signal is "ON".
- Please refer to "9.1 Homing Start" about detailed explanation of Homing Start.
- D device signal (axis1 in Operation, etc) which used in the example above is an assumption that saving the axis state value in D device area with XSRD command.

6.3.2 Floating origin setting (Command : XFLT)

(1) Program

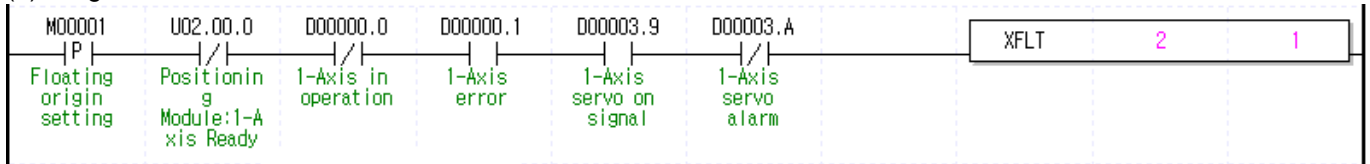

(2) Description

Device	Description
M00001	axis1 floating origin setting input
U02.00.0	axis1 ready
D00000.0	axis1 in operation
D00000.1	axis1 error state
D00003.9	axis1 servo on signal
D00003.A	axis1 servo error

Command	XFLT				Floating origin setting
Operand	OP1	Slot	Constant	WORD	Slot No. installed with positioning module
	OP2	Axis	PMLK,constant,D,Z,R,ZR	WORD	Command axis XBF-PN04B: 1axis~4axis XBF-PN08B:1axis~8axis

※ PMLK means P, M, L and K areas.

- (a) If the floating origin setting command is executed, the current position is changed to the origin address, “0” and the origin determination signal (bit) is ON.
- (b) Floating origin setting that different from homing origin is set at the current position and can not be set in operation.
- (c) D device signal (axis1 in Operation, etc) which used in the example above is an assumption that saving the axis state value in D device area with XSRD command.

6.3.3 Direct start (Command : XDST)

(1) Program

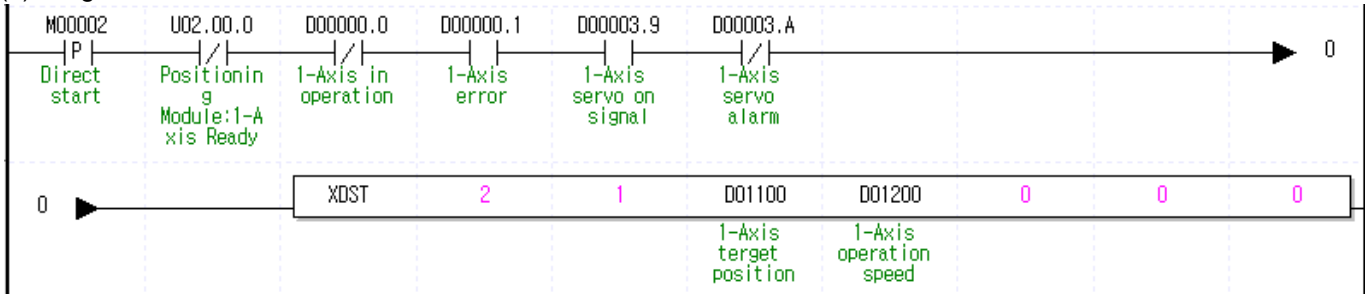

(2) Description

Device	Description
M00002	axis1 direct start input
U02.00.0	axis1 ready
D00000.0	axis1 signal in operation
D00000.1	axis1 error state
D00003.9	axis1 servo on
D00003.A	axis1 servo error

Command	XDST				Direct start
Operand	OP1	Slot	Constant	WORD	Slot No. installed with positioning module
	OP2	Axis	PMLK,constant,D,Z,R,ZR	WORD	Command axis XBF-PN04B: 1axis~4axis XBF-PN08B:1axis~8axis
	OP3	Goal position	PMLK,constant,D,Z,R,ZR	DINT	Goal position (-2,147,483,648 ~ 2,147,483,647)
	OP4	Goal speed	PMLK,constant,D,Z,R,ZR	DWORD	Goal speed
	OP5	Dwell time	PMLK,constant,D,Z,R,ZR	WORD	Dwell time (0~65535)
	OP6	M code	PMLK,constant,D,Z,R,ZR	WORD	M code (0~65535)
	OP7	Control word	PMLK,constant,D,Z,R,ZR	WORD	

※ PMLK means P, M, L and K areas.

(a) Details of Control word (OP7) for each Bit are as follows.

15 ~ 12	11 ~ 10	9 ~ 8	7 ~ 5	4	3 ~ 2	1 ~ 0
-	Dec. Time	Acc. Time	-	0:Absolute 1:Incremental	-	0:Position Control 1:Speed control 2:Feed Control 3: Shortest Position Control

(b) If control word is h0012, it shall be set by Feed control, incremental, acc./dec. time 1.

(c) No.2~3, 5~7, 12~15 Bit of control word is the unused area and does not affect the setting.

(d) D device signal (axis1 in Operation, etc) which used in the example above is an assumption that saving the axis state value in D device area with XSRD command.

6.3.4 Indirect start (Command : XIST)

(1) Program

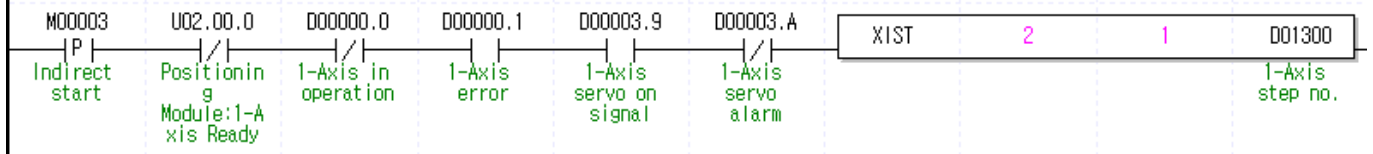

(2) Description

Device	Description
M00003	axis1 indirect start input
U02.00.0	axis1 ready
D00000.0	axis1 in operation
D00000.1	axis1 error state
D01300	axis1 step no.
D00003.9	axis1 servo on signal
D00003.A	axis1 servo error

Command	DST				Indirect start
	OP1	Slot	Constant	WORD	Slot No. installed with positioning module
Operand	OP2	Axis	PMLK,constant,D,Z,R,ZR	WORD	Command axis XBF-PN04B: 1axis~4axis XBF-PN08B:1axis~8axis
	OP3	Operation step	PMLK,constant,D,Z,R,ZR	WORD	Step No. to operate (0~400)

※ PMLK means P, M, L and K areas.

- (a) If operation step No. is set as "0" in indirect start, it will be operated as current step No. If other number except 0 is set as the operation step number, it operates only for step no. set.
- (b) If operation pattern is set as Continuous or Keep, several steps can be operated by an indirect start command.
- (c) D device signal (axis1 in Operation, etc) which used in the example above is an assumption that saving the axis state value in D device area with XSRD command.

6.3.5 Simultaneous Start (Command : XSST)

(1) Program

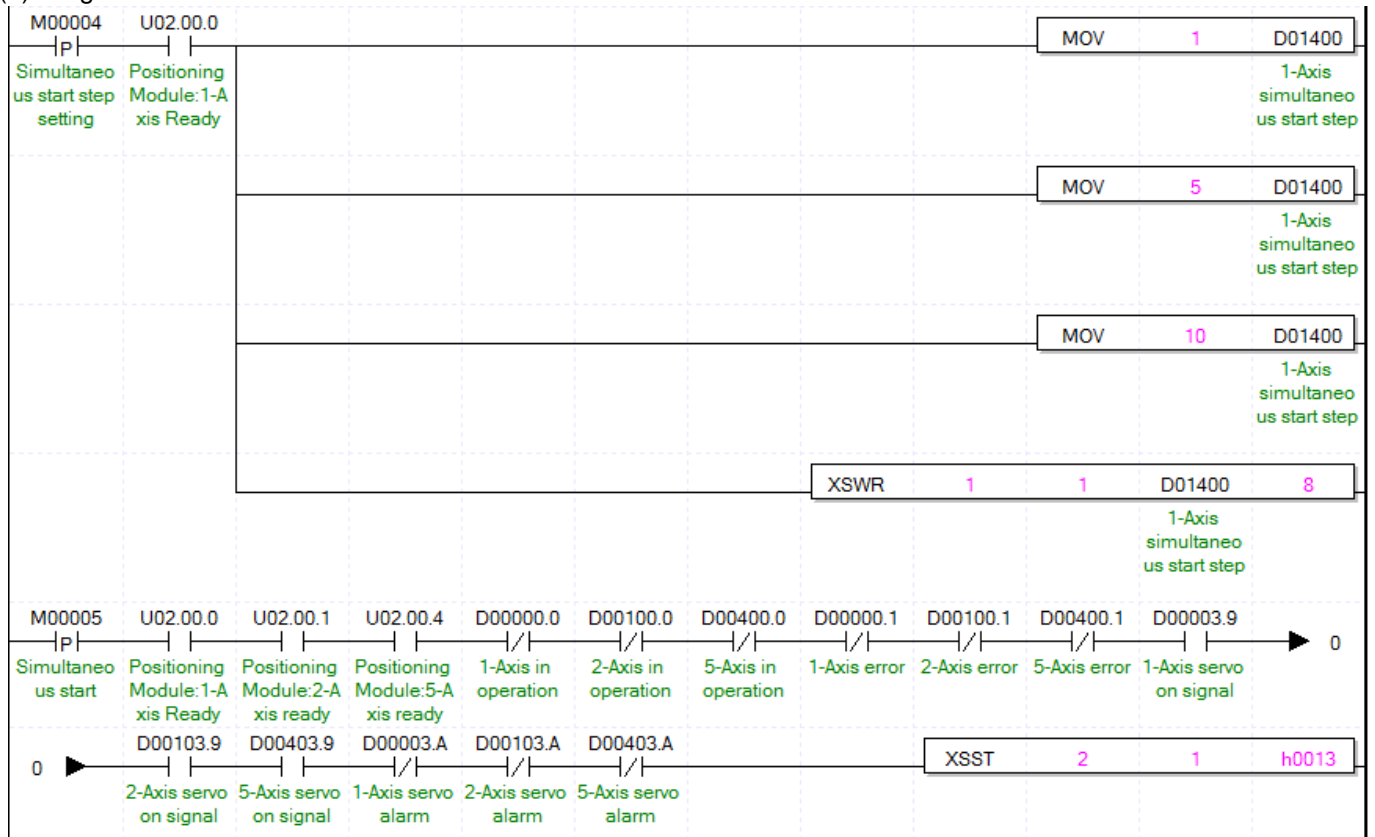

(2) Description

Device	Description
M00004	Simultaneous start step setting
M00005	Simultaneous start input
U02.00.0	axis1 ready
U02.00.1	axis2 ready
U02.00.4	axis5 ready
D00000.0	axis1 in operation
D00000.1	axis1 error state
D00003.9	axis1 servo on signal
D00003.A	axis1 servo error
D00100.0	axis2 in operation
D00100.1	axis2 error state
D00103.9	axis2 servo on signal
D00103.A	axis2 servo error
D00400.0	axis5 in operation
D00400.1	axis5 error state
D00403.9	axis5 servo on signal
D00403.A	axis5 servo error
D01400	axis1 simultaneous start step
D01401	axis2 simultaneous start step
D01404	axis5 simultaneous start step

Command	XSST				Linear interpolation
Operand	OP1	Slot	Constant	WORD	Slot No. installed with positioning module
	OP2	Axis	PMLK,constant,D,Z,R,ZR	WORD	Command axis XBF-PN04B: 1axis~4axis XBF-PN08B:1axis~8axis
	OP3	Operation axis	PMLK,constant,D,Z,R,ZR	WORD	Operating axis setting

※ PMLK means P, M, L and K areas.

- (a) Simultaneous command is the command operates simultaneous steps saved in 'operation axis(OP3)' at a time.
- (b) Axis setting is set by setting the bits to the axis

15 ~ 8 Bit	7Bit	6Bit	5Bit	4Bit	3Bit	2Bit	1Bit	0Bit
Not use	Axis8	Axis7	Axis6	Axis5	Axis4	Axis3	Axis2	Axis1

That is, axis5, axis2, axis1 will be set if set as h0013

But, the axis which command simultaneous start is basically included without being set in operating axis.

- (c) In the example program above, axis1 operates step no.1, axis2 operates step no.5, axis5 operates step no.10.
- (d) To set steps of axis for simultaneous start, use XSWR command or PUT/PUTP command to set simultaneous start step no. on simultaneous start step memory address. This must be complete before simultaneous start executes.
- (e) D device signal (axis1 in Operation, etc) which used in the example above is an assumption that saving the axis state value in D device area with XSRD command.

6.3.6 Simultaneous Start Step Setting (Comand : XSWR)

(1) Program

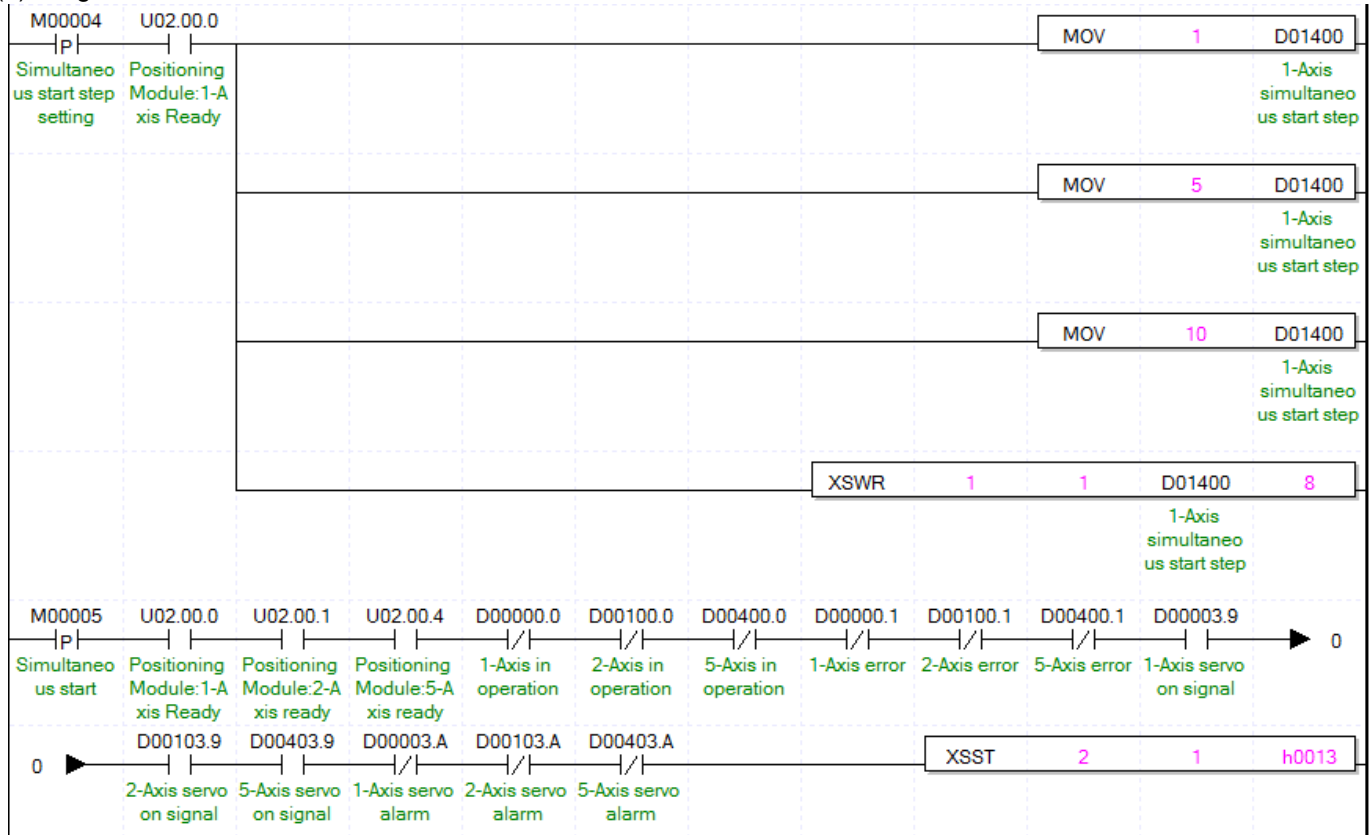

(2) Description

Refer to the chapter 6.3.5 for device description.

Command	XSWR				Simultaneous start step setting
Operand	OP1	Slot	Constant	WORD	Slot no. installed with positioning module
	OP2	Axis	PMLK,constant,D,Z,R,ZR	WORD	Command axis XBF-PN04B: 1axis~4axis XBF-PN08B:1axis~8axis
	OP3	Device	PMLK,constant,D,Z,R,ZR	WORD	The device leading no. has simultaneous start step no.
	OP4	Number of step	PMLK,constant,D,Z,R,ZR	WORD	The number of step to use.

※ PMLK means P, M, L and K areas.

- (a) In the example program, axis 1, axis 2, axis5 operate no.1 step, no.5 step, no.10 step respectively.
- (c) To set steps of axis for simultaneous start, use XSWR command or PUT/PUTP command to set simultaneous start step no. on simultaneous start step memory address. This must be complete before simultaneous start executes.
- (c) When using PUT command to set simultaneous start, refer to the memory address of “5.1.3 Simultaneous start step data” and “6.1.2 internal memory writing”.

6.3.7 Ellipse Interpolation (Command : XELIN)

(1) Program

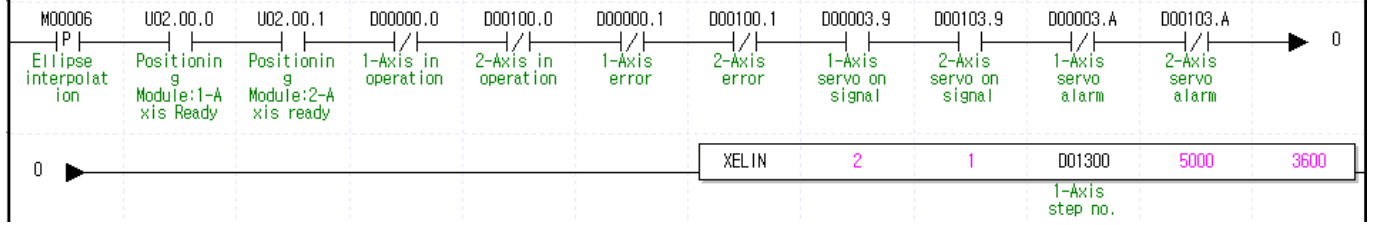

(2) Description

Device	Description
M00006	axis1/axis2 ellipse interpolation input
U02.00.0	axis1 ready
U02.00.1	axis1 ready
D00000.0	axis1 in operation
D00000.1	axis1 error state
D00003.9	axis1 servo on signal
D00003.A	axis1 servo error
D00100.0	axis2 in operation
D00100.1	axis2 error state
D00103.9	axis1 servo on signal
D00103.A	axis1 servo error
D01300	axis1 operation step

Command	XSST				Simultaneous start
	OP1	Slot	Constant	WORD	Slot No. installed with positioning module
Operand	OP2	Axis	PMLK,constant,D,Z,R,ZR	WORD	Command axis XBF-PN04B: 1axis~4axis XBF-PN08B: 1axis~8axis
	OP3	operation step	PMLK,constant,D,Z,R,ZR	WORD	Step no. to execute ellipse interpolation
	OP4	Ellipse ratio	PMLK,constant,D,Z,R,ZR	WORD	Ellipse ratio (%)
	OP5	Operation degree	PMLK,constant,D,Z,R,ZR	WORD	Degree for ellipse interpolation

※ PMLK means P, M, L and K areas.

- (a) Ellipse interpolation distorts operation data which set as circular arc interpolation by ratio set on ellipse ratio and executes ellipse operation by set degree on OP5. Therefore, step of operation data set on operation step (OP3) must be set as circular arc interpolation control.
- (b) Ellipse ratio is able to be set from 1 to 65535, has $[X10^{-2}\%]$ unit. That is, 65535 will be 655.35%.
- (c) Operation degree is able to be set from 1 to 65535, has $[X10^{-1} \text{ degree}]$ unit. That is, 3650 will be 365.0 degree.
- (d) D device signal (axis1 in Operation, etc) which used in the example above is an assumption that saving the axis state value in D device area with XSRD command.

6.3.8 Speed/Position Switching Control (Command : XVTP)

(1) Program

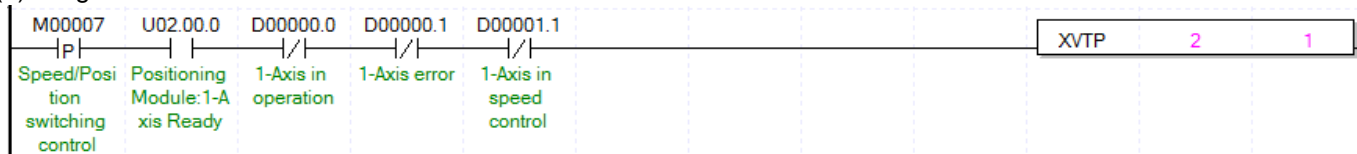

(2) Description

Device	Description
M00007	axis1 speed/position switching control input
U02.00.0	axis1 ready
D00000.0	axis1 in operation
D00000.1	axis1 error state
D00001.1	axis1 in speed control

Command	XVTP				Speed/position switching control
Operand	OP1	Slot	Constant	WORD	Slot No. installed with positioning module
	OP2	Axis	PMLK,constant,D,Z,R,ZR	WORD	Command axis XBF-PN04B: 1axis~4axis XBF-PN08B:1axis~8axis

※ PMLK means P, M, L and K areas.

- (a) If speed/position switching control is executed in the state of speed control operation, it shall be switched to position control and positioning operation is executed with the position set in the speed control.
- (b) For detail description about speed/position switching control, refer to “9.2.14 Speed/Position Switching Control”
- (c) D device signal (axis1 in Operation, etc) which used in the example above is an assumption that saving the axis state value in D device area with XSRD command.

6.3.9 Position specified Speed/Position Switching Control (Command : XVTPP)

(1) Program

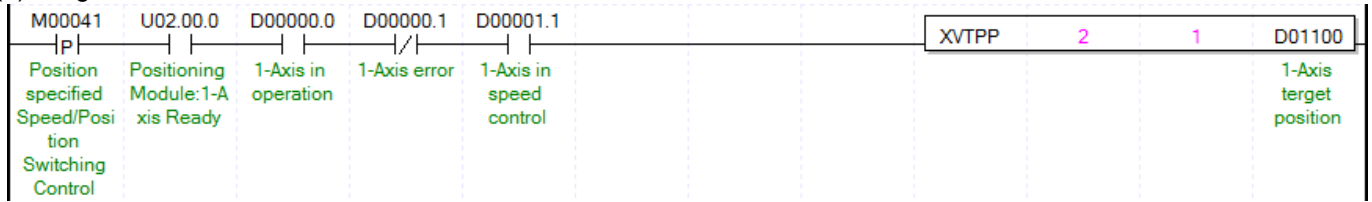

(2) Description

Device	Description
M000041	1-axis position-specified speed/position switching control input
U02.00.0	1-axis ready
D00000.0	1-axis in operation
D00000.1	1-axis error state
D00001.1	1-axis in speed control
D01100	1-axis target position

Command	XVTPP				Speed/position switching control
Operand	OP1	Slot	Constant	WORD	Slot No. installed with positioning module
	OP2	Axis	PMLK,constant,D,Z,R,ZR	WORD	Command axis XBF-PN04B: 1axis~4axis XBF-PN08B:1axis~8axis
	OP3	Target position	PMLK,constant,D,Z,R,ZR	DINT	Transfer amount after position control switching

※ PMLK means P, M, L and K areas.

- (a) If speed/position switching control is executed in the state of speed control operation, it shall be switched to position control and positioning operation is executed with the position set in the speed control.
- (b) For detail description about speed/position switching control, refer to “9.2.15 Position-specified Speed/Position Switching Control”
- (c) D device signal (axis1 in Operation, etc) which used in the example above is an assumption that saving the axis state value in D device area with XSRD command.

6.3.10 Position/Speed Switching Control (Command : XPTV)

(1) Program

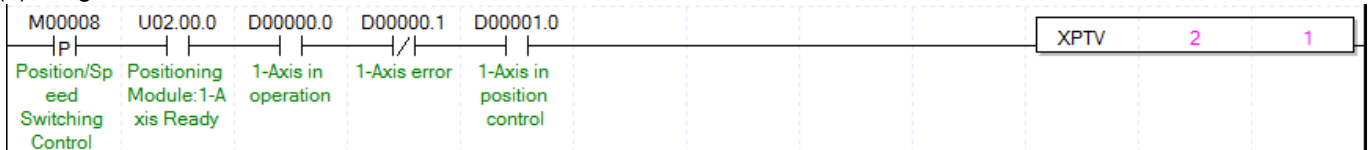

(2) Description

Device	Description
M00008	axis1 position/speed switching control input
U02.00.0	axis1 ready
D00000.0	axis1 in operation
D00000.1	axis1 error state
D00001.0	axis1 in position control

Command	PTV				Position/speed switching control
Operand	OP1	Slot	Constant	WORD	Slot No. installed with positioning module
	OP2	Axis	PMLK,constant,D,Z,R,ZR	WORD	Command axis XBF-PN04B: 1axis~4axis XBF-PN08B:1axis~8axis

※ PMLK means P, M, L and K areas.

- If position/speed switching control is executed during position control operation, it is converted to speed control, operates at the speed set during position control and stops by executing deceleration stop.
- For the detail description about position/speed switching control, refer to "9.2.16 Position/Speed Switching Control".
- D device signal (axis1 in Operation, etc) which used in the example above is an assumption that saving the axis state value in D device area with XSRD command.

6.3.11 Position/Torque Switching Control (Command : XPTT)

(1) Program

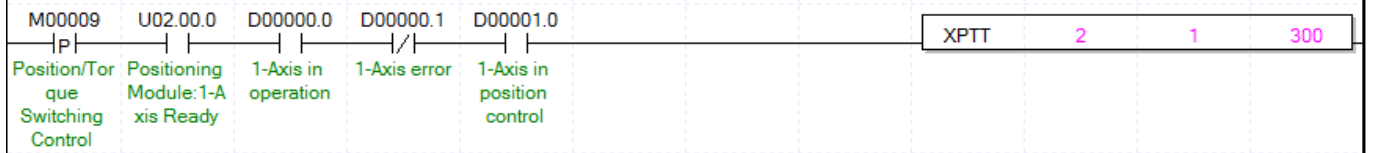

(2) Description

Device	Description
M00009	axis1 position/torque switching control input
U02.00.0	axis1 ready
D00000.0	axis1 in operation
D00000.1	axis1 error state
D00001.0	axis1 in position control

Command	PTV				Position/speed switching control
	OP1	Slot	Constant	WORD	Slot No. installed with positioning module
Operand	OP2	Axis	PMLK,constant,D,Z,R,ZR	WORD	Command axis XBF-PN04B: 1axis~4axis XBF-PN08B:1axis~8axis
	OP3	torque	PMLK,constant,D,Z,R,ZR	INT	Operation torque(-32768 ~ 32767)

※ PMLK means P, M, L and K areas.

- (a) If position/torque switching control is executed during position control operation, it is converted to torque control with torque value of OP3, and keeps torque operation until stop by executing deceleration stop.
- (b) Range of Torque value is -32768 ~ 32767 and unit is [%]. The allowable range of torque value may vary according to the connected servo drive. In general, target torque value is limited to the maximum torque setting.
- (c) For the detail description about position/torque switching control, refer to “9.2.17 Position/Torque Switching Control”.
- (d) D device signal (axis1 in Operation, etc) which used in the example above is an assumption that it saves the axis state value in D device area with XSRD command.

6.3.12 Deceleration Stop (Command : XSTP)

(1) Program

M0000A	U02.00.0	D00000.0	D00000.1	XSTP	2	1	D01500
Dec. Stop	Positioning Module:1-A xis Ready	1-Axis in operation	1-Axis error				1-Axis Dec. stop Dec.time

(2) Description

Device	Description
M0000A	axis1 deceleration stop input
U02.00.0	axis1 ready
D00000.0	axis1 in operation
D00000.1	axis1 error state
D01500	axis1 deceleration stop time setting

Command	STP				Deceleration stop
Operand	OP1	Slot	Constant	WORD	Slot No. installed with positioning module
	OP2	Axis	PMLK,constant,D,Z,R,ZR	WORD	Command axis XBF-PN04B: 1axis~4axis XBF-PN08B:1axis~8axis
	OP3	Deceleration time	PMLK,constant,D,Z,R,ZR	WORD	deceleration time (0 ~ 2,147,483,647 ms)

※ PMLK means P, M, L and K areas.

- Deceleration stop carry out the command in deceleration, acceleration and equal speed areas.
- Deceleration time means the time required from deceleration start to stop and it is available to set from 0 ~ 2,147,483,647ms. But if setting as "0", it stops only by deceleration time set at the beginning of operation.
- Deceleration time means the time required from the speed limit of basic parameter on operation axis to stop.
- If deceleration stop command is executed in speed sync., position sync. or CAM operation, it stops speed sync., position sync. or CAM operation depending on current operation control state.
- D device signal (axis1 in Operation, etc) which used in the example above is an assumption that saving the axis state value in D device area with XSRD command.

6.3.13 Skip Operation (Command : XSKP)

(1) Program

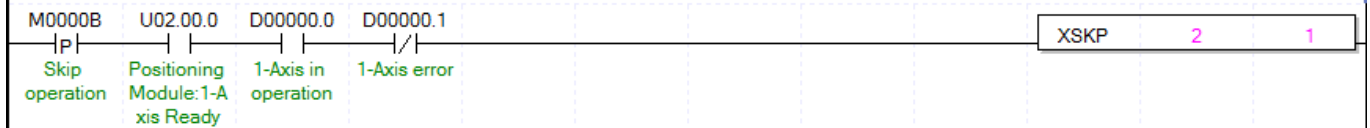

(2) Description

Device	Description
M0000B	axis1 skip operation input
U02.00.0	axis1 ready
D00000.0	axis1 in operation
D00000.1	axis1 error state

Command	SKP			Skip operation	
Operand	OP1	Slot	Constant	WORD	Slot No. installed with positioning module
	OP2	Axis	PMLK,constant,D,Z,R,ZR	WORD	Command axis XBF-PN04B: 1axis~4axis XBF-PN08B:1axis~8axis

※ PMLK means P, M, L and K areas.

- (a) This ends and stops the operation of step which is in operation currently and then continues to operate the next step.
- (b) For the details description of skip operation, refer to “9.5.3 Skip Operation.
- (c) D device signal (axis1 in Operation, etc) which used in the example above is an assumption that saving the axis state value in D device area with XSRD command.

6.3.14 Synchronous Start by Position (Command : XSSP)

(1) Program

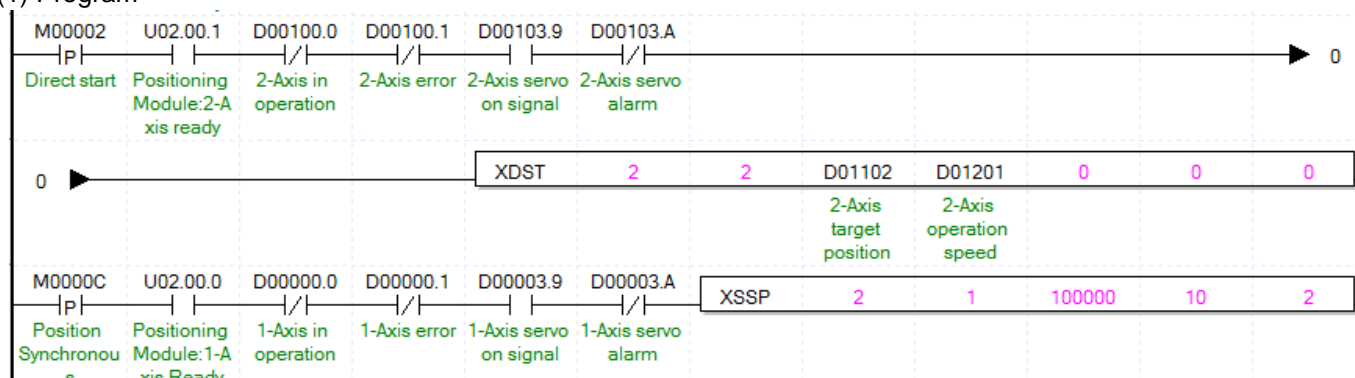

(2) Description

Device	Description
M0000C	axis1 synchronous start by position input
M00002	axis1 direct start input
U02.00.0	axis1 ready
U02.00.0	Axis2 ready
D00000.0	axis1 in operation
D00000.1	axis1 error
D00003.9	axis1 servo on signal
D00003.A	axis1 servo error
D00100.0	axis2 in operation
D00100.1	axis2 error state
D00103.9	axis2 servo on signal
D00103.A	axis2 servo error

Command	XSSP			Synchronous start by position	
Operand	OP1	Slot	Constant	WORD	Slot No. installed with positioning module
	OP2	Axis	PMLK,constant,D,Z,R,ZR	WORD	Command axis XBF-PN04B: 1axis~4axis XBF-PN08B:1axis~8axis
	OP3	Main axis position	PMLK,constant,D,Z,R,ZR	DINT	Position of sub axis to operate
	OP4	Operation step	PMLK,constant,D,Z,R,ZR	WORD	Sub axis operation step No. (0~ 400)
	OP5	Main axis	PMLK,constant,D,Z,R,ZR	WORD	Main axis (1 ~ 10 : axis1 ~ axis8, Encoder1, Encoder2)

※ PMLK means P, M, L and K areas.

- (a) If the command of synchronous start by position is executed, it becomes in operation state but motor does not operate actually. At the point that axis2 as main axis setting starts and its current position is 1000, axis1 will start and the motor will operate.
- (b) For the detail description about position synchronous start, refer to “9.4.2 position synchronous start control”
- (c) D device signal (axis1 in Operation, etc) which used in the example above is an assumption that saving the axis state value in D device area with XSRD command.

6.3.15 Speed Sync (Command : XSSS)

(1) Program

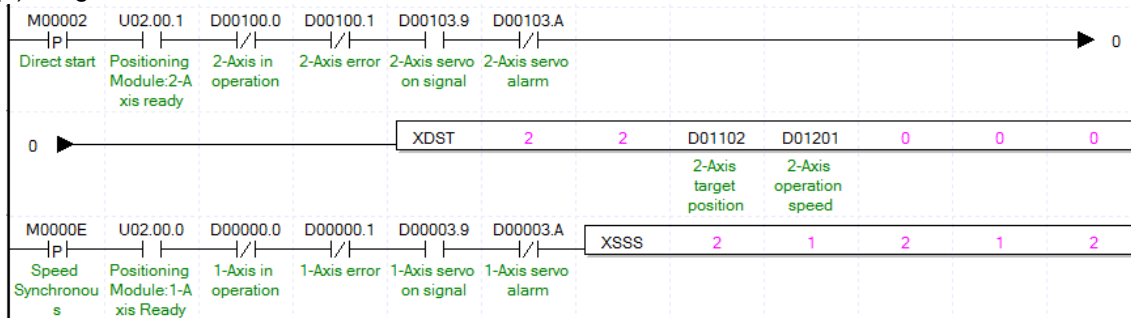

(2) Description

Device	Description
M0000E	axis1 speed sync start input
M00002	axis2 direct start input
U02.00.0	axis1 in operation
U02.00.1	axis2 in operation
D00000.0	axis1 in operation
D00000.1	axis1 error state
D00003.9	axis1 servo on signal
D00003.A	axis1 servo error
D00100.0	axis2 in operation
D00100.1	axis2 error state
D00103.9	axis2 servo on signal
D00103.A	axis2 servo error

Command	XSSS				Synchronous start by speed
	OP1	Slot	Constant	WORD	Slot No. installed with positioning module
Operand	OP2	Axis	PMLK,constant,D,Z,R,ZR	WORD	Command axis XBF-PN04B: 1axis~4axis XBF-PN08B:1axis~8axis
	OP3	Main axis ratio	PMLK,constant,D,Z,R,ZR	WORD	Speed sync. main axis ratio (-32768 ~ 32767)
	OP4	Subordinate axis ratio	PMLK,constant,D,Z,R,ZR	WORD	Speed sync. sub axis ratio (-32768 ~ 32767)
	OP5	Main axis	PMLK,constant,D,Z,R,ZR	WORD	Main axis(1 ~ 8 : axis1 ~ axis8, 9 : Encoder1, 10 : Encoder2)

※ PMLK means P, M, L and K areas.

- (a) In the example program above, if the command of synchronous start by speed is executed, axis1 (subordinate axis) is indicated as 'in operation' but the motor does not operate. If operating axis2 set as the main axis, axis1 (subordinate axis) is operated depending on the designated ratio between main axis (OP3) and sub axis(OP4).
- (b) If speed sync. ratio (sub axis ratio / main axis ratio) is positive integer, sub axis operation turns main axis direction, if not positive integer, it turns the opposite of main axis direction.
- (c) For example, if main axis ratio is 3, sub axis ratio is 2, when main axis moves by 3000, sub axis moves 2000.
- (d) For the detail description about speed sync., refer to "9.4.1 Speed Synchronous Start Control".
- (e) D device signal (axis1 in Operation, etc) which used in the example above is an assumption that saving the axis state value in D device area with XSRD command.

6.3.16 Position-specified Speed synch (Command: XSSSP)

(1) Program

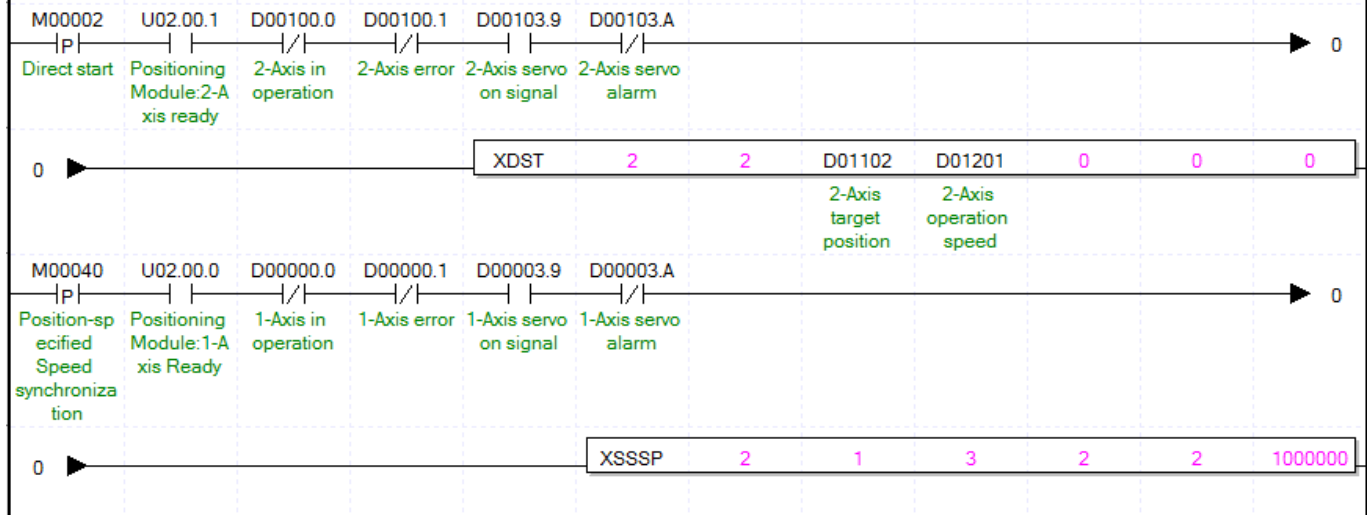

(2) Description

Device	Description
M00040	axis1 position-specified speed synch input
M00002	axis2 direct start input
U02.00.0	axis1 ready
U02.00.1	axis2 ready
D00000.0	axis1 in operation
D00000.1	axis1 error state
D00003.9	axis1 servo on signal
D00003.A	axis1 servo error
D00100.0	axis2 in operation
D00100.1	axis2 error state
D00103.9	axis2 servo on signal
D00103.A	axis2 servo error

Command	XSSSP			Speed synchronous start by position
Operand	OP1	Slot	Constant	WORD
	OP2	Axis	PMLK,constant,D,Z,R,ZR	WORD
	OP3	Main axis ratio	PMLK,constant,D,Z,R,ZR	INT
	OP4	Sub axis ratio	PMLK,constant,D,Z,R,ZR	INT
	OP5	Main axis	PMLK,constant,D,Z,R,ZR	WORD
	OP6	Target position	PMLK,constant,D,Z,R,ZR	DINT

※ PMLK means P area, M area, L area, K area.

(a) In the example program above, if the command of synchronous start by speed is executed, axis1 (subordinate axis) is indicated as 'in operation' but the motor does not operate. If operating axis2 set as the main axis, axis1 (subordinate axis) is operated depending on the designated ratio between main axis (OP3) and sub axis(OP4).

- (b) If speed sync. ratio (sub axis ratio / main axis ratio) is positive integer, sub axis operation turns main axis direction, if not positive integer, it turns the opposite of main axis direction.
- (c) For example, if main axis ratio is 3, sub axis ratio is 2 and target position is 1,000,000, when main axis moves by 3000, sub axis moves 2000. It stops by where position of main axis is at 1,000,000.
- (d) For the detail description about speed sync., refer to "9.4.1 Speed Synchronous Start Control".
- (e) D device signal (axis1 in Operation, etc) which used in the example above is an assumption that saving the axis state value in D device area with XSRD command.

6.3.17 CAM Operation (Command : XCAM)

(1) Program

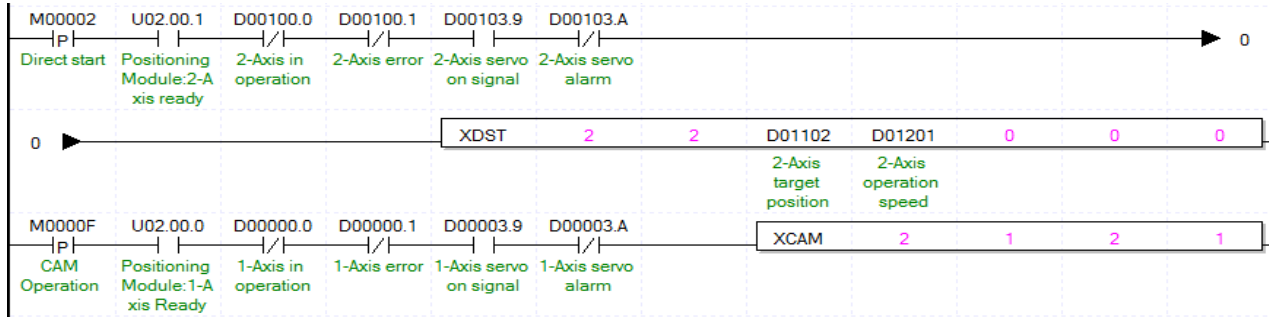

(2)

Description

□	D
□	e
□	s
□	v
□	i
□	c
□	r
□	e
□	p
□	t
□	i
□	o
□	n
□	N
□	o
□	x
□	i
□	s
□	1
□	F
□	c
□	a
□	n
□	o
□	p
□	e
□	r
□	a
□	t
□	i
□	n
□	i
□	n
□	p
□	u
□	t
□	N
□	o
□	x
□	i
□	s
□	1
□	2
□	d
□	i
□	r
□	e
□	c
□	t
□	s

	t a r t i n p u t
U 0 x 2 . 0 0 . 0 0	a x i s . 0 1 . r e a d y
U 0 x 2 . 0 0 . 0 1	a x i s . 0 2 . r e a d y
□ 0 0 0 0 . 0 0	a x i s . 0 1 . i n o p e r a t i o n
□ 0 0 0 0 . 0	a x i s . 0 1 . e

1	r
	r
	O
	r
	s
	t
	a
	t
	e
	a
	0
	x
	0
	i
	0
	s
	0
	1
	3
	.
	s
9	e
	r
	v
	o
	.
	o
	n
	.
	s
	i
	g
	n
	a
	l
	a
	0
	x
	0
	i
	0
	s
	0
	1
	3
	.
A	s
	e
	r
	v
	o
	.
	e
	r
	r
	o
	r
	.
	a
	0
	x
	0
	i
	1
	0
	2
	0
	.
0	i
	n

	o p e r a t i o n
□	a
0x	0
0i	1
1s	0
02	0
.	e
1	r
	r
	r
	o
	r
	s
	t
	a
	t
	e
□	a
0x	0
0i	1
1s	0
02	0
3	3
.	s
9	e
	r
	v
	o
	o
	n
	s
	i
	g
	n
	a
	l
□	a
0x	0
0i	1
1s	0
02	0
3	3
.	s
A	e
	r
	v

Command	XCAM				Cam Operation
Operand	OP1	Slot	Constant	WORD	Slot No. installed with positioning module
	OP2	Axis	PMLK,constant,D,Z,R,ZR	WORD	Command axis XBF-PN04B: 1axis~4axis XBF-PN08B:1axis~8axis
	OP3	Main axis	PMLK,constant,D,Z,R,ZR	WORD	Main axis (1 ~ 8 : axis1 ~ axis8, 9 : Encoder1, 10:Encoder2)
	OP4	Cam Block	PMLK,constant,D,Z,R,ZR	WORD	Cam data block to apply to operation (1 ~ 9)

※ PMLK means P, M, L and K areas.

- (a) In the example program above, if cam operation command is executed, axis1 (sub axis) is indicated as “In operation” but the motor does not operate actually. When axis2 starts operating as a main axis, motor of axis1 starts operating toward sub axis location depending on data which set on cam block (OP4).
- (b) Maximum number of cam data block is 8.
- (c) Cam data is set on positioning package but has to be downloaded at positioning module before cam operation.
- (d) For the detail description about cam operation, refer to “9.4.3 Cam Operation (XCAM).
- (e) D device signal (axis1 in Operation, etc) which used in the example above is an assumption that saving the axis state value in D device area with XSRD command.
- (f) In order to use user CAM operation, you have to set CAM block number as 9.
- (g) In the case of user CAM operation, it is possible to change the user cam data with write variable data command during operation.
- (h) For detailed information on user CAM operation, refer to “94.4. user CAM operation”.

6.3.18 Main axis offset-designated CAM Operation (Command : XCAMO)

(1) Program

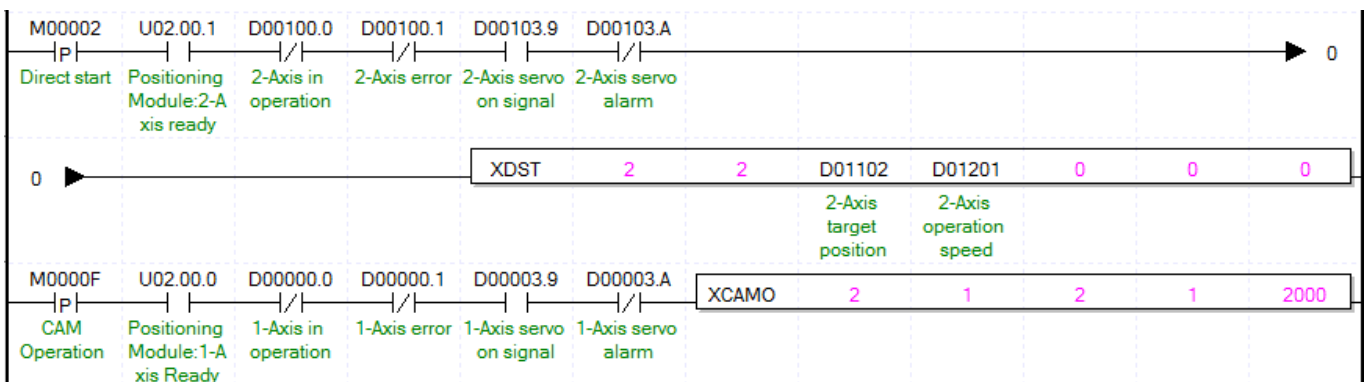

(2) Description

Device	Description
M0000F	axis1 cam operation input
M00002	axis1 direct start input
U02.00.0	axis1 ready
U02.00.1	axis2 ready
D00000.0	axis1 in operation
D00000.1	axis1 error state
D00003.9	axis1 servo on signal
D00003.A	axis1 servo error
D00100.0	axis2 in operation
D00100.1	axis2 error state
D00103.9	axis2 servo on signal
D00103.A	axis2 servo error

Command	XCAMO				Cam Operation
	OP1	Slot	Constant	WORD	Slot No. installed with positioning module
Operand	OP2	Axis	PMLK,constant,D,Z,R,ZR	WORD	Command axis XBF-PN04B: 1axis~4axis XBF-PN08B:1axis~8axis
	OP3	Main axis	PMLK,constant,D,Z,R,ZR	WORD	Main axis (1 ~ 8 : axis1 ~ axis8, 9 : Encoder1, 10:Encoder2)
	OP4	Cam Block	PMLK,constant,D,Z,R,ZR	WORD	Cam data block to apply to operation (1 ~ 9)
	OP5	Main axis offset	PMLK,constant,D,Z,R,ZR	DINT	Main axis position to start CAM operation

※ PMLK means P, M, L and K areas.

- In the example program above, if cam operation command is executed, axis1 (sub axis) is indicated as "In operation" but the motor does not operate actually. When axis2 starts operating as a main axis and transfer amount becomes 2000, motor of axis1 starts operating toward sub axis location depending on data which set on cam block (OP4).
- Maximum number of cam data block is 8.
- Cam data is set on positioning package but has to be downloaded at positioning module before cam operation.
- For the detail description about cam operation, refer to "9.4.3 Cam Operation (XCAM).
- D device signal (axis1 in Operation, etc) which used in the example above is an assumption that saving the axis state value in D device area with XSRD command.
- In order to use user CAM operation, you have to set CAM block number as 9.
- For detailed information on user CAM operation, refer to "9.4.4. user CAM operation".

6.3.19 Position Override (Command : XPOR)

(1) Program

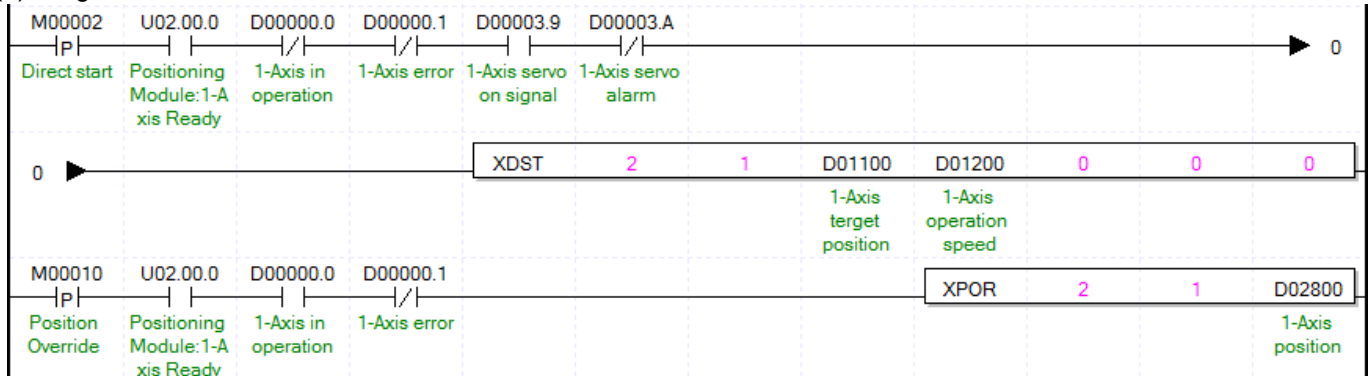

(2) Description

Device	Description
M00010	axis1 position override input
M00002	axis1 direct start input
U02.00.0	axis1 ready
D00000.0	axis1 in operation
D00000.1	axis1 error state
D00003.9	axis1 servo on signal
D00003.A	axis1 servo error
D01100	Goal position value
D02800	Position override value

Command	XPOR				Position override
Operand	OP1	Slot	Constant	WORD	Slot No. installed with positioning module
	OP2	Axis	PMLK,constant,D,Z,R,ZR	WORD	Command axis XBF-PN04B: 1axis~4axis XBF-PN08B: 1axis~8axis
	OP3	Position value	PMLK,constant,D,Z,R,ZR	DINT	Goal position value to change (Absolute coordinate)

※ PMLK means P, M, L and K areas.

- (a) If position override is executed before reaching goal position, goal position shall be changed with D02800 for positioning operation. If executing positioning position override after passing a position to execute position override, it stops at the current position.
- (b) Position override set on position override value is absolute coordinate position.
- (c) For the detail description about position override, refer to “9.5.4 Position Override”.
- (d) D device signal (axis1 in Operation, etc) which used in the example above is an assumption that saving the axis state value in D device area with XSRD command.

6.3.20 Speed Override (Command : XSOR)

(1) Program

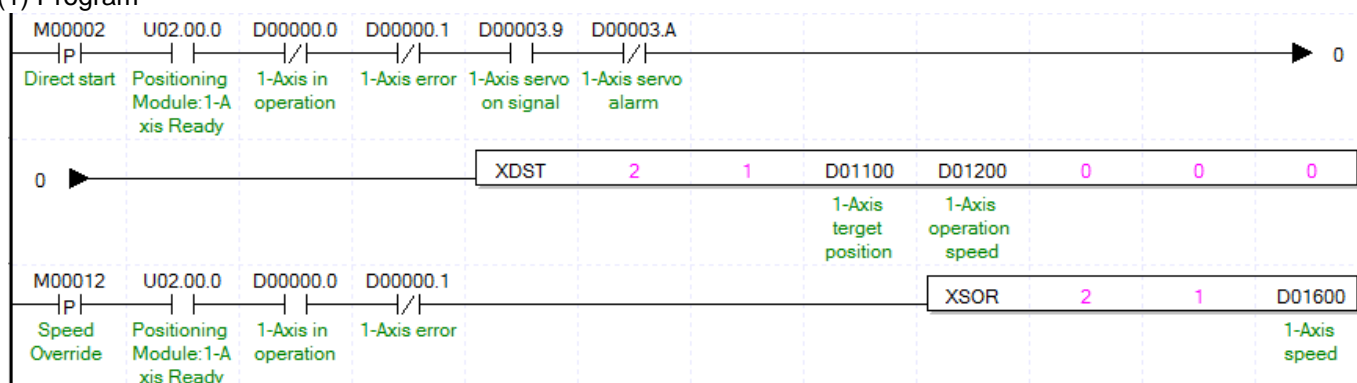

(2) Description

Device	Description
M00012	axis1 speed override input
M00002	axis1 direct start input
U02.00.0	axis1 ready
D00000.0	axis1 in operation
D00000.1	axis1 error state
D00003.9	axis1 servo on signal
D00003.A	axis1 servo error
D01200	Goal speed value
D01600	Speed override value

Command	XSOR				Speed override
	OP1	Slot	Constant	WORD	Slot No. installed with positioning module
Operand	OP2	Axis	PMLK,constant,D,Z,R,ZR	WORD	Command axis XBF-PN04B: 1axis~4axis XBF-PN08B: 1axis~8axis
	OP3	Speed value	PMLK,constant,D,Z,R,ZR	DWORD	Goal speed value to change

※ PMLK means P, M, L and K areas.

- (a) Speed override value (OP3) will be set as “%” or “Speed value” depending on the value which set on “speed override” in common parameter.
- (b) If unit of speed override value is %, the setting area is from 1 to 65,535, it means 0.01% ~ 655.35%.
- (c) If unit of speed override value is speed value, setting area is from 1 to speed limit value. The speed limit value is set on “Speed limit value” of basic parameter and unit of speed override value depends on unit of axis.
- (d) For the detail description about speed override operation, refer to “9.5.5 Speed Override”.
- (e) D device signal (axis1 in Operation, etc) which used in the example above is an assumption that saving the axis state value in D device area with XSRD command.

6.3.21 Position-specified Speed Override (Command : XPSO)

(1) Program

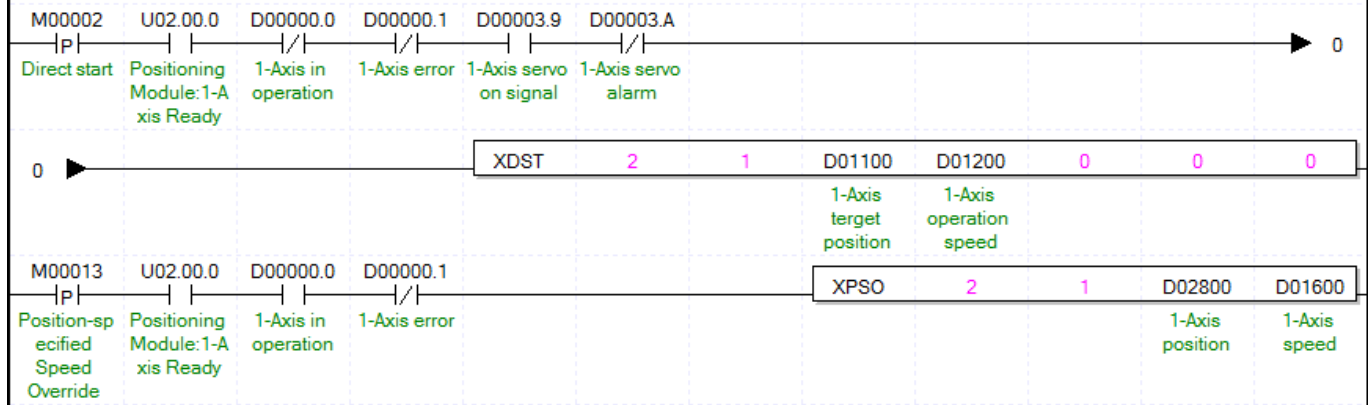

(2) Description

Device	Description
M00013	axis1 position assigned speed override input
M00012	axis1 direct start input
U02.00.0	axis1 ready
D00000.0	axis1 in operation
D00000.1	axis1 error state
D00003.9	axis1 servo on signal
D00003.A	axis1 servo error
D01200	Goal speed value
D01600	Speed override value
D02800	Position value to execute speed change

Command	XPSO				Position specified speed override
Operand	OP1	Slot	Constant	WORD	Slot No. installed with positioning module
	OP2	Axis	PMLK,constant,D,Z,R,ZR	WORD	Command axis XBF-PN04B: 1axis~4axis XBF-PN08B:1axis~8axis
	OP3	Position value	PMLK,constant,D,Z,R,ZR	DINT	Position value to change the speed
	OP4	Speed value	PMLK,constant,D,Z,R,ZR	DWORD	Goal speed value to change

※ PMLK means P, M, L and K areas.

- (a) Speed override value (OP3) will be set as “%” or “Speed value” depending on the value which set on “speed override” in common parameter.
- (b) If unit of speed override value is %, the setting area is from 1 to 65,535, it means 0.01% ~ 655.35%.
- (c) If unit of speed override value is speed value, setting area is from 1 to speed limit value. The speed limit value is set on “Speed limit value” of basic parameter and unit of speed override value depends on unit of axis.
- (d) In the example program above, axis1 position assigned speed override input(M00013) become “on” to execute position assigned speed override after axis1 direct start input (M00011) become “on”. When the position of axis1 is located at the position where set at D02800, the speed will be changed to the value set at D01600.
- (e) For the detail description about position assigned speed override operation, refer to “9.5.6 Position Assigned Speed Override”.
- (f) D device signal (axis1 in Operation, etc) which used in the example above is an assumption that saving the axis state value in D device area with XSRD command.

6.3.22 Continuous Operation (Command : XNMV)

(1) Program

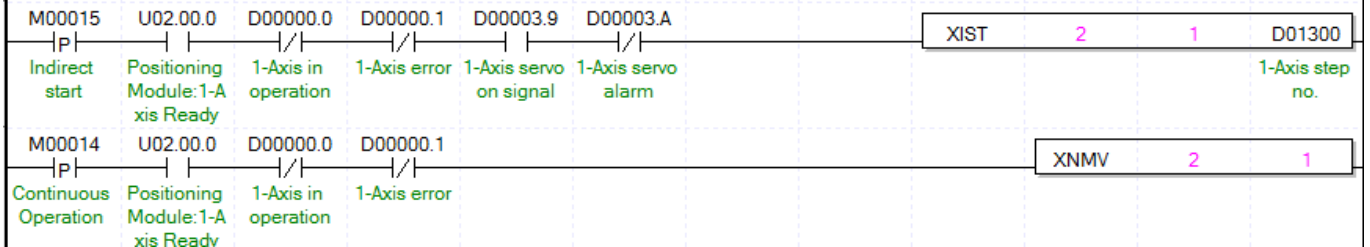

(2) Description

Device	Description
M00014	axis1 continuous operation input
M00015	axis1 indirect start input
U02.00.0	axis1 ready
D00000.0	axis1 in operation
D00000.1	axis1 error state
D00003.9	axis1 servo on signal
D00003.A	axis1 servo error
D01300	1axis operation step

Command	XNMV			Continuous operation	
Operand	OP1	Slot	Constant	WORD	Slot No. installed with positioning module
	OP2	Axis	PMLK,constant,D,Z,R,ZR	WORD	Command axis XBF-PN04B: 1axis~4axis XBF-PN08B:1axis~8axis

※ PMLK means P, M, L and K areas.

- (a) If continuous operation command is executed, the step No. is changed from the step in current operation to the next step No. and continues positioning operation to the speed of the next step and goal position. Connection with the next step is executed by continuous operation pattern.
- (b) Continuous operation command changes the only current operation pattern in operation, not the operation data.
- (c) For the detail description about continuous operation, refer to “9.5.2 Continuous Operation”.
- (d) D device signal (axis1 in Operation, etc) which used in the example above is an assumption that saving the axis state value in D device area with XSRD command.

6.3.23 Inching Operation (Command : XINCH)

(1) Program

M00016	U02.00.0	D00000.0	D00000.1	D00003.9	D00003.A	XINCH	2	1	D01000
Inching Operation	Positioning Module:1-Axis Ready	1-Axis in operation	1-Axis error	1-Axis servo on signal	1-Axis servo alarm				1-Axis inching amount

(2) Description

Device	Description
M00016	axis1 inching operation input
U02.00.0	axis1 ready
D00000.0	axis1 in operation
D00000.1	axis1 error state
D00003.9	axis1 servo on signal
D00003.A	axis1 servo error
D01000	axis1 inching value

Command	XINCH				Inching operation
Operand	OP1	Slot	Constant	WORD	Slot No. installed with positioning module
	OP2	Axis	PMLK,constant,D,Z,R,ZR	WORD	Command axis XBF-PN04B: 1axis~4axis XBF-PN08B: 1axis~8axis
	OP3	Position value	PMLK,constant,D,Z,R,ZR	DINT	Position value to move for inching operation

※ PMLK means P, M, L and K areas.

- It carries out the relative coordinate operation by inching operation speed set in manual operation parameter as much as position value (OP3).
- For the detail description about inching operation, refer to "9.3.2 Inching Operation".
- D device signal (axis1 in Operation, etc) which used in the example above is an assumption that saving the axis state value in D device area with XSRD command.

6.3.24 Return to the Position before Manual Operation (Command : XRTP)

(1) Program

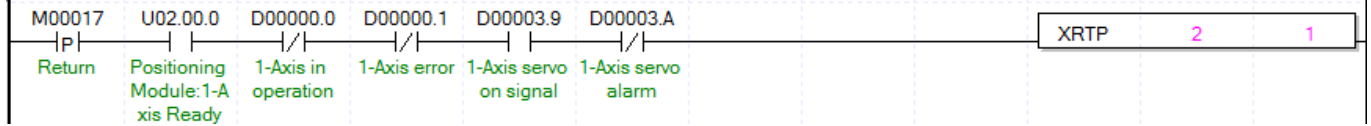

(2) Description

Device	Description
M00017	axis1 return to the position before manual operation start input
U02.00.0	axis1 ready
D00000.0	axis1 in operation
D00000.1	axis1 error state
D00003.9	axis1 servo on signal
D00003.A	axis1 servo error

Command	XRTP				Return to the position before manual operation
	OP1	Slot	Constant	WORD	Slot No. installed with positioning module
Operand	OP2	Axis	PMLK,constant,D,Z,R,ZR	WORD	Command axis XBF-PN04B: 1axis~4axis XBF-PN08B:1axis~8axis

※ PMLK means P, M, L and K areas.

- (a) If the current position is changed as external axis speed sync. operation, inching operation, Jog operation after completing the positioning, it returns to the previous position of manual operation.
- (b) Return to the position before manual operation command will be ignored if it is not in manual operation.
- (c) The detail description about return to the previous position of manual operation, refer to “9.3.3 Return to the Previous Position of Manual Operation”
- (d) D device signal (axis1 in Operation, etc) which used in the example above is an assumption that saving the axis state value in D device area with XSRD command.

6.3.25 Start Step No. Change (Command : XSNS)

(1) Program

M00018	U02.00.0	D00000.0	D00000.1	XSNS	2	1	D01300
Change start step no.	Positioning Module:1-Axis Ready	1-Axis in operation	1-Axis error				1-Axis step no.

(2) Description

Device	Description
M00018	axis1 start step No. change input
U02.00.0	axis1 ready
D00000.0	axis1 signal in operation
D00000.1	axis1 error state
D01300	axis1 start step no. to change

Command	XSNS				Change start step No.
Operand	OP1	Slot	Constant	WORD	Slot No. installed with positioning module
	OP2	Axis	PMLK,constant,D,Z,R,ZR	WORD	Command axis XBF-PN04B: 1axis~4axis XBF-PN08B:1axis~8axis
	OP3	Step No.	PMLK,constant,D,Z,R,ZR	WORD	step No. to change with start step (1~400)

※ PMLK means P, M, L and K areas.

- (a) Change the current step into the step value which set on step no.(OP3)
- (b) It is not available to be executed in operation.
- (c) D device signal (axis1 in Operation, etc) which used in the example above is an assumption that saving the axis state value in D device area with XSRD command.

6.3.26 Repeat Step No. Change (Command : XSRS)

(1) Program

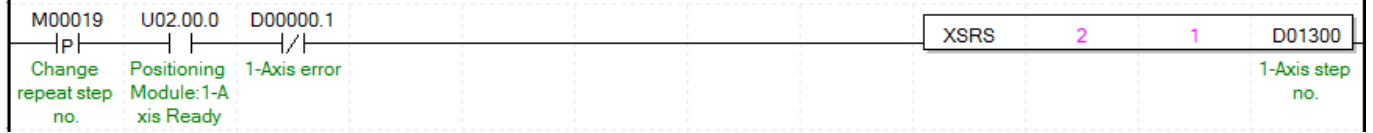

(2) Description

Device	Description
M00019	axis1 start step No. change input
U02.00.0	axis1 ready
D00000.1	axis1 error state
D01300	axis1 repeat step no. to change

Command	XSRS			Repeat step No. change
	OP1	Slot	Constant	WORD
Operand	OP1	Slot	PMLK,constant,D,Z,R,ZR	WORD
	OP2	Axis	PMLK,constant,D,Z,R,ZR	WORD
	OP3	Step No.	PMLK,constant,D,Z,R,ZR	WORD

※ PMLK means P, M, L and K areas.

- (a) Change repeat step into the step value which set on step no.(OP3).
- (b) Repeat step No. change is available for command execution even during positioning operation.
- (c) Set the next step after finish operating designated repeat step.
- (d) The detail description about "9.5.10 Repeat Operation Step no. Change".
- (e) D device signal (axis1 in Operation, etc) which used in the example above is an assumption that saving the axis state value in D device area with XSRS command.

6.3.27 M code Release (Command : XMOF)

(1) Program

M0001A	U02.00.0	D00000.1	D00000.3	XMOF	2	1
Release M code	Positioning Module:1-Axis Ready	1-Axis error	1-Axis M code signal			

(2) Description

Device	Description
M0001A	axis1 M code release input
U02.00.0	axis1 ready
D00000.1	axis1 error state
D00000.3	axis1 M code signal

Command	XMOF				M code release
Operand	OP1	Slot	Constant	WORD	Slot No. installed with positioning module
	OP2	Axis	PMLK,constant,D,Z,R,ZR	WORD	Command axis XBF-PN04B: 1axis~4axis XBF-PN08B:1axis~8axis

※ PMLK means P, M, L and K areas.

- When M code occurs, M code signal and M code No. are released at the same time (M code and M code No. are changed to OFF and 0, respectively).
- It is available to be executed in operation.
- D device signal (axis1 Signal in Operation, etc) which used in the example above is an assumption that saving the axis state value in D device area with XSRD command.

6.3.28 Current Position Preset (Command : XPRS)

(1) Program

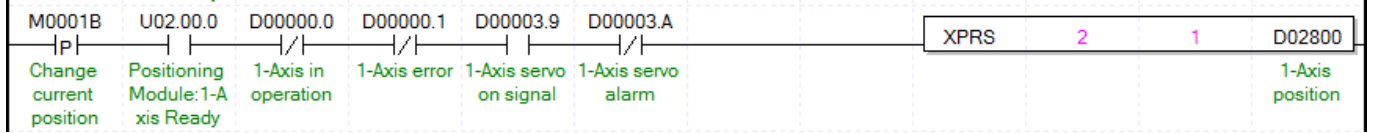

(2) Description

Device	Description
M0001B	axis1 current position preset input
U02.00.0	axis1 ready
D00000.0	axis1 in operation
D00000.1	axis1 error state
D00003.9	axis1 servo on signal
D00003.A	axis1 error
D02800	axis1 preset position value

Command	XPRS			Current position preset
Operand	OP1	Slot	Constant	WORD Slot No. installed with positioning module
	OP2	Axis	PMLK,constant,D,Z,R,ZR	WORD Command axis XBF-PN04B: 1axis~4axis XBF-PN08B:1axis~8axis
	OP3	Position value	PMLK,constant,D,Z,R,ZR	DINT Current position value to change

※ PMLK means P, M, L and K areas.

- (a) The command that change the current position value to the designated position (OP3).
- (b) If current position preset command is executed in the origin unsettled state, positioning state signal (bit) is ON and the current position is changed by setting value (OP3).
- (c) D device signal (axis1 in Operation, etc) which used in the example above is an assumption that saving the axis state value in D device area with XSRD command.

6.3.29 Encoder Preset (Command : XEPRS)

(1) Program

M0001C P	XEPRS	2	D02900	0
Encoder 1 Preset			Encoder 1 position	

(2) Description

Device	Description
M0001C	encoder preset input (Encoder1)
M0001D	encoder preset input (Encoder2)
D02900	encoder1 preset position value
D2902	encoder2 preset position value

Command	XEPRS				Encoder preset
Operand	OP1	Slot	Constant	WORD	Slot No. installed with positioning module
	OP2	Position value	PMLK,constant,D,Z,R,ZR	DINT	Current position value to change
	OP3	Encoder	PMLK,constant,D,Z,R,ZR	WORD	-

※ PMLK means P, M, L and K areas.

※ Since the encoder input terminal is 1 within positioning module, it works regardless of the setting item of OP3 encoder.

(a) This is the command that changes the current position to the designated position.

6.3.30 Teaching Array (Command : XTEAA)

(1) Program

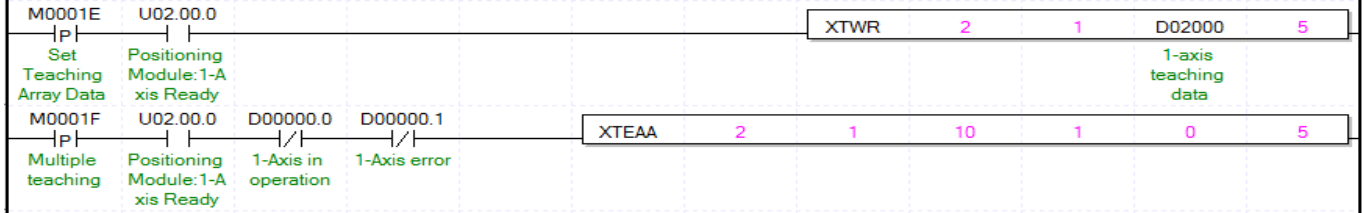

(2) Description

Device	Description
M0001E	axis1 teaching data setting input
M0001F	axis1 teaching array input
U02.00.0	axis1 ready
D00000.0	axis1 in operation
D00000.1	axis1 error state
D02000	axis1 teaching array data leading address

Command	XTEAA				Teaching Array
Operand	OP1	Slot	Constant	WORD	Slot No. installed with positioning module
	OP2	Axis	PMLK,constant,D,Z,R,ZR	WORD	Command axis XBF-PN04B: 1axis~4axis XBF-PN08B: 1axis~8axis
	OP3	Teaching step	PMLK,constant,D,Z,R,ZR	WORD	leading step No. for teaching (0~400)
	OP4	Teaching method	PMLK,constant,D,Z,R,ZR	WORD	0:RAM Teaching, 1:ROM Teaching
	OP5	Teaching item	PMLK,constant,D,Z,R,ZR	WORD	0:Position teaching 1:Speed teaching
	OP6	Number of Teaching	PMLK,constant,D,Z,R,ZR	WORD	Number of step for Teaching (1~16)

※ PMLK means P, M, L and K areas.

- (a) This is the command that change the goal position or goal speed (OP5) among the operation data to the number as many as from the designated step (OP3) to the number of teaching (OP6). In the case of operating RAM teaching according to the teaching method (OP3), the changed value is maintained during positioning module is connected to power. In the case of operating ROM teaching, it is maintained without power connection of positioning module.
- (b) Even though teaching can be performed even when the axis subject to teaching is being operated but, only the current step's data is reflected after the current step operation is completed if the step that is currently running is within the step area while other steps' data are immediately changed.
- (c) The number of times for ROM teaching is not limited because operation data of positioning module is saved on MRAM.
- (d) Before executing teaching array, teaching data should be set in the teaching array setting area. For teaching array data setting, refer to TWR command.
- (e) In the example program above, execute ROM teaching for position data between no.10 step and no.14 step of axis1 operation data using 5 axis1 teaching data.
- (f) D device signal (axis1 Signal in Operation, etc) which used in the example above is an assumption that saving the axis state value in D device area with XSRD command.

6.3.31 Set Teaching Array Data (Command: XTWR)

(1) Program

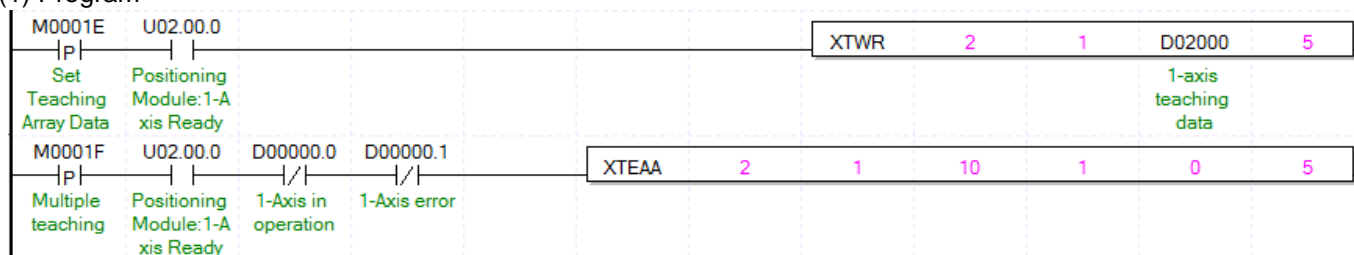

(2) Description

Device	Description
M0001E	axis1 Teaching array data setting input
M0001F	axis1 Teaching array input
U02.00.0	axis1 ready
D00000.0	axis1 in operation
D00000.1	axis1 error state
D02000	axis1 Teaching array data leading address

Command	XTWR				Teaching Array Data Setting
Operand	OP1	Slot	Constant	WORD	Slot No. installed with positioning module
	OP2	Axis	PMLK,constant,D,Z,R,ZR	WORD	Command axis XBF-PN04B: 1axis~4axis XBF-PN08B:1axis~8axis
	OP3	Device	PMLK,D,Z,R,ZR	WORD	Leading device No. with teaching array data
	OP3	Number of data	PMLK,constant,D,Z,R,ZR	WORD	Number of data to save

※ PMLK means P, M, L and K areas.

- Teaching data must be set in teaching array data setting area before teaching array is executed.
- Teaching array is not executed only by executing teaching array data setting command. Please refer to teaching array command (TEAA).
- In the example program above, execute ROM teaching for position data between no.10 step and no.14 step of axis1 operation data using 5 axis1 teaching data.

(d) According to the leading No. of device, the data are set in teaching array data area as follows.

No.	Device NO.	Teaching array data
1	Device + 0	Teaching array data 1
2	Device + 2	Teaching array data 2
3	Device + 4	Teaching array data 3
4	Device + 6	Teaching array data 4
5	Device + 8	Teaching array data 5
6	Device + 10	Teaching array data 6
7	Device + 12	Teaching array data 7
8	Device + 14	Teaching array data 8
9	Device + 16	Teaching array data 9
10	Device + 18	Teaching array data 10
11	Device + 20	Teaching array data 11
12	Device + 22	Teaching array data 12
13	Device + 24	Teaching array data 13
14	Device + 26	Teaching array data 14
15	Device + 28	Teaching array data 15
16	Device + 30	Teaching array data 16

(e) Teaching array data can be set by using PUT command. For this, refer to memory address of “5.1.2 Teaching data” and “6.1.2 Internal Memory Writing”. If use PUT command in the example program above, it displayed like the picture below.

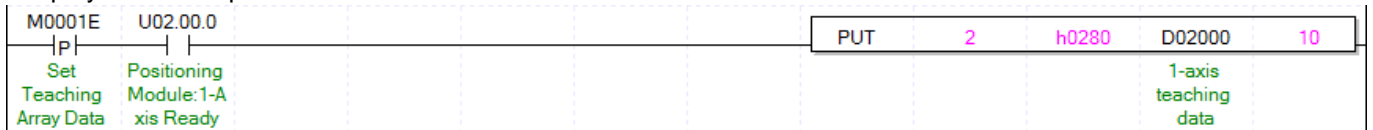

(f) D device signal (axis1 in Operation, etc) which used in the example above is an assumption that saving the axis state value in D device area with XSRD command.

6.3.32 Set Basic Parameter (Command : XSBP)

(1) Program

M00020	U02.00.0	D00000.0	D00000.1	XSBP	2	1	D02100	D02102	0
Set Basic Parameter	Positioning Module:1-A xis Ready	1-Axis in operation	1-Axis error				Parameter value	Parameter item	

(2) Description

Device	Description
M00020	axis1 basic parameter setting input
U02.00.0	axis1 ready
D00000.0	axis1 in operation
D00000.1	axis1 error state
D02100	Parameter value
D02102	Parameter items

Command	XSBP				Basic parameter Teaching
Operand	OP1	Slot	Constant	WORD	Slot No. installed with positioning module
	OP2	Axis	PMLK,constant,D,Z,R,ZR	WORD	Command axis XBF-PN04B: 1axis~4axis XBF-PN08B:1axis~8axis
	OP3	Parameter value	PMLK,constant,D,Z,R,ZR	DWORD	Parameter value to change
	OP4	Parameter item	PMLK,constant,D,Z,R,ZR	WORD	Parameter item to change (1~17, 255)
	OP5	Setting method	PMLK,constant,D,Z,R,ZR	WORD	0: RAM setting, 1: ROM setting

※ PMLK means P, M, L and K areas.

- This is the command that changes the value of the item (OP4) which already set among basic parameter items to setting value (OP3). In the case of RAM setting by the setting method (OP5), the changed value is maintained during positioning module is being connected to power. In the case of ROM setting, it is maintained without the power connection of positioning module.
- The number of ROM setting operating is unlimited because basic parameter of positioning module is saved on MRAM.
- Basic parameter setting command is unavailable to be executed when the axis is operating.

(d) Basic parameter items

Setting Value	Items	Setting Range
1	Speed limit value	mm : 1 ~ 2,147,483,647 [$\times 10^2$ mm/min] Inch : 1 ~ 2,147,483,647 [$\times 10^3$ Inch/min] degree : 1 ~ 2,147,483,647 [$\times 10^3$ degree/min] pulse : 1 ~ 2,147,483,647 [pulse/sec]
2	Acc. Time 1	1 ~ 2,147,483,647 [ms]
3	Acc. Time 2	
4	Acc. Time 3	
5	Acc. Time 4	
6	Dec. Time 1	1 ~ 2,147,483,647 [ms]
7	Dec. Time 2	
8	Dec. Time 3	
9	Dec. Time 4	
10	Emg. Stop Dec. Time	1 ~ 2,147,483,647 [ms]
11	Pulse per rotation	1 ~ 200,000,000
12	Travel per rotation	
13	Unit	0:Pulse, 1:mm, 2:Inch, 3:Degree
14	Unit multiplier	0: x 1, 1: x 10, 2: x 100, 3: x 1000
15	Speed command unit	0: Unit/Time, 1: rpm
16	Encoder select*	0: Incremental encoder, 1:Absolute encoder
17	Current position display correction	0 ~ 255

- (e) For the change value (OP3) setting range of each basic parameter item (OP4) which already set, refer to "4.1.1 Basic Parameter Content"
- (f) In the example program above, it changes the item that saved on D02102 of axis1 basic parameter to the value that saved on D02100 using RAM setting method. In the case of D02102=10, D02100=100, it sets sudden stop time as "100ms" using RAM setting method.
- (g) D device signal (axis1 in Operation, etc) which used in the example above is an assumption that saving the axis state value in D device area with XSRD command.

(h) If you want to set up all items of basic parameter with one XSBP command, you have to set up hFF(255) at OP4 parameter item. At this time, first, items of basic parameter should be saved at multiple teaching memory address below. You can set up data with PUT instruction or XTWR instruction.

Memory address								Contents
1axis	2axis	3axis	4axis	5axis	6axis	7axis	8axis	
280	300	380	400	480	500	580	600	Speed limit
281	301	381	401	481	501	581	601	
282	302	382	402	482	502	582	602	Acc. time1
283	303	383	403	483	503	583	603	
284	304	384	404	484	504	584	604	Acc. time2
285	305	385	405	485	505	585	605	
286	306	386	406	486	506	586	606	Acc. time3
287	307	387	407	487	507	587	607	
288	308	388	408	488	508	588	608	Acc. time4
289	309	389	409	489	509	589	609	
28A	30A	38A	40A	48A	50A	58A	60A	Dec. time1
28B	30B	38B	40B	48B	50B	58B	60B	
28C	30C	38C	40C	48C	50C	58C	60C	Dec. time2
28D	30D	38D	40D	48D	50D	58D	60D	
28E	30E	38E	40E	48E	50E	58E	60E	Dec. time3
28F	30F	38F	40F	48F	50F	58F	60F	
290	310	390	410	490	510	590	610	Dec. time4
291	311	391	411	491	511	591	611	
292	312	392	412	492	512	592	612	Dec. time when EM. Stop
293	313	393	413	493	513	593	613	
294	314	394	414	494	514	594	614	Pulses per rotation
295	315	395	415	495	515	595	615	
296	316	396	416	496	516	596	616	Travel distance per rotation
297	317	397	417	497	517	597	617	
298	318	398	418	498	518	598	618	Unit
299	319	399	419	499	519	599	619	Unit multiply
29A	31A	39A	41A	49A	51A	59A	61A	Speed unit
29B	31B	39B	41B	49B	51B	59B	61B	Encoder select
29C	31C	39C	41C	49C	51C	59C	61C	Current position display correction
29D	31D	39D	41D	49D	51D	59D	61D	-
29E	31E	39E	41E	49E	51E	59E	61E	-
29F	31F	39F	41F	49F	51F	59F	61F	-

The following is example chaning all items of basic parameter with one XSBP command.

If M00000 is on, data set up at D00000 ~ D00026 will be saved at teaching data memory and basic parameter entire setup command will be executed.

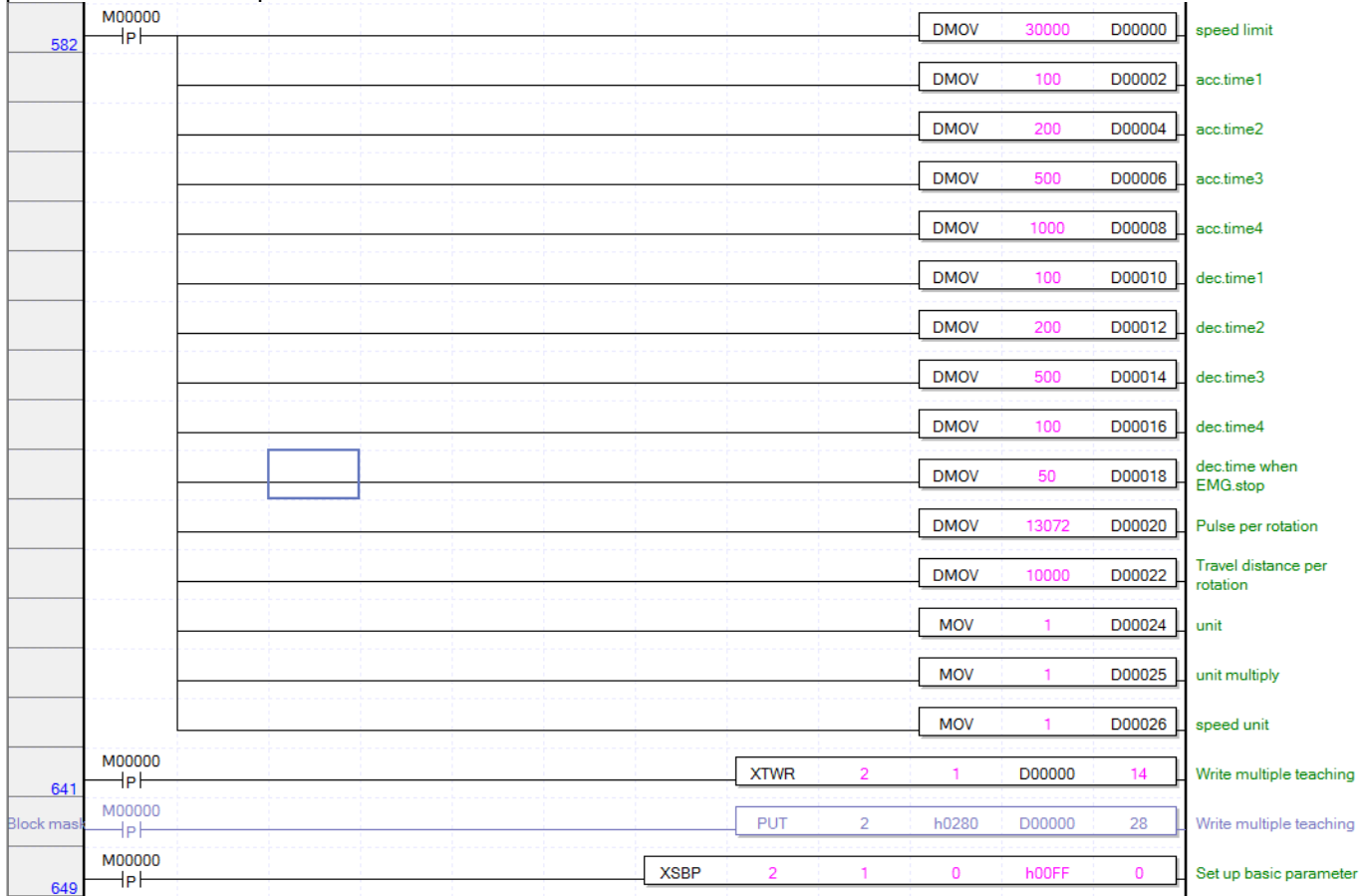

Remark

1. When using a couple of parameter setup command to change a couple of parameter item, make the interval of execution of each command to be more than time needed to execute the setup command. If a couple of commands are executed by one condition, it may not work properly.

- ※ Parameter setup command execution time
 - 2ms (when using 3 axes) ~ 4ms (when using 8 axes)

※ [Example] You can change acc. time 1 ~ acc. time 4 as follows.



Basic parameter setup commands are executed sequentially from basic parameter no.2 item to basic parameter no.5 item after M00100 is on.

6.3.33 Set Extended Parameter (Command : XSEP)

(1) Program

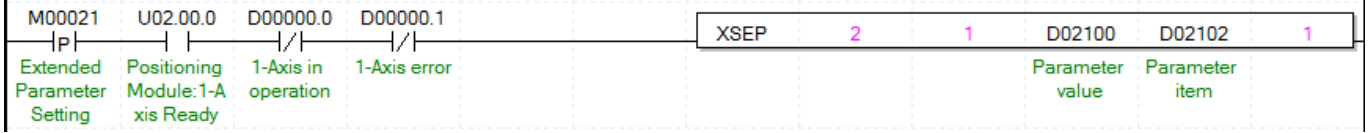

(2) Description

Device	Description
M00021	axis1 extended parameter setting input
U02.00.0	axis1 ready
D00000.0	axis1 in operation
D00000.1	axis1 error state
D02100	Parameter value
D02102	Parameter items

Command	XSEP				Extended parameter Teaching
Operand	OP1	Slot	Constant	WORD	Slot No. installed with positioning module
	OP2	Axis	PMLK,constant,D,Z,R,ZR	WORD	Command axis XBF-PN04B: 1axis~4axis XBF-PN08B:1axis~8axis
	OP3	Parameter value	PMLK,constant,D,Z,R,ZR	DINT	Parameter value to change
	OP4	Parameter item	PMLK,constant,D,Z,R,ZR	WORD	Parameter item to change (1~2, 4~19)
	OP5	Setting Method	PMLK,constant,D,Z,R,ZR	WORD	0: RAM setting, 1: ROM setting

※ PMLK means P, M, L and K areas.

- (a) This is the command that changes the value of the item (OP4) which already set among basic parameter items to setting value (OP3). In the case of RAM setting by the setting method (OP5), the changed value is maintained during positioning module is being connected to power. In the case of ROM setting, it is maintained without the power connection of positioning module.
- (b) The number of ROM setting operating is unlimited because basic parameter of positioning module is saved on MRAM.
- (c) Basic parameter setting command is unavailable to be executed when the axis is operating.

(d) Extended parameter items

Setting value	Items	Setting value
1	S/W upper limit	mm:-2147483648 ~ 2147483647[X10 ⁻⁴ mm] Inch:-2147483648 ~ 2147483647[X10 ⁻⁵ Inch]
2	S/W lower limit	degree:-2147483648~2147483647[X10 ⁻⁵ degree] pulse:-2147483648 ~ 2147483647[pulse]
3	-	-
4	Positioning complete time	0 ~ 65,535[ms]
5	S-Curve ratio	1 ~ 100
6	In-position width	mm: 0 ~ 65,535[X10 ⁻⁴ mm] inch: 0 ~ 65,535[X10 ⁻⁵ Inch] degree: 0 ~ 65,535[X10 ⁻⁵ degree] pulse: 0 ~ 65,535[pulse]
7	axis2 Linear interpolation continuous operation circular arc insertion position	mm: 0 ~ 2147483647[X10 ⁻⁴ mm] Inch: 0 ~ 2147483647[X10 ⁻⁵ Inch] degree: 0 ~ 2147483647[X10 ⁻⁵ degree] pulse: 0 ~ 2147483647[pulse]
8	Acc./dec. pattern	0: Trapezoid operation, 1: S-Curve operation
9	M code mode	0: None, 1: With, 2: After
10	Upper&Lower limit detection during speed control	0: Don't detect, 1: Detect
11	Positioning complete condition	0: Dwell Time 1: In position 2: Dwell Time AND In position 3: Dwell Time OR In position
12	Interpolation continuous operation type	0: pass target pos, 1: pass near pos
13	Arc insertion	0: Insert arc, 1: Don't insert.
14	External command selection	0: external VTP, 1: external stop
15	External command	0:disable, 1: enable
16	Position-specified speed override coordinate	0: Absolute, 1: Incremental
17	Infinite running repeat pos	mm: 1 ~ 2147483647[X10 ⁻⁴ mm] Inch: 1 ~ 2147483647[X10 ⁻⁵ Inch] degree: 1 ~ 2147483647[X10 ⁻⁵ degree] pulse: 1 ~ 2147483647[pulse]
18	Infinite running repeat	0: disable, 1: enable
19	Speed/position switching coordinate	0: incremental, 1: absolute
20	Interpolation speed selection	0: main axis speed, 1: synthetic speed

(e) For the change value (OP3) setting range of each extended parameter item (OP4) which already set, refer to "4.2.1 Extended Parameter Content"

(f) In the example program above, it changes the item that saved on D02102 of axis1 basic parameter to the value that saved on D02100 using RAM setting method. In the case of D02102=8, D02100=1, it sets sudden stop time as "With" using RAM setting method.

(g) D device signal (axis1 in Operation, etc) which used in the example above is an assumption that saving the axis state value in D device area with XSRD command.

(h) If you want to set up all items of extended parameter with one XSEP command, you have to set up hFF(255) at OP4 parameter item. At this time, first, items of extended parameter should be saved at multiple teaching memory address below. You can set up data with PUT instruction or XTWR instruction.

Memory address								Contents
1axis	2axis	3axis	4axis	5axis	6axis	7axis	8axis	
280	300	380	400	480	500	580	600	Soft upper limit
281	301	381	401	481	501	581	601	
282	302	382	402	482	502	582	602	Soft lower limit
283	303	383	403	483	503	583	603	
284	304	384	404	484	504	584	604	-
285	305	385	405	485	505	585	605	Positioning complete time
286	306	386	406	486	506	586	606	S-curve ratio
287	307	387	407	487	507	587	607	Command in-position width
288	308	388	408	488	508	588	608	
289	309	389	409	489	509	589	609	2- axis linear interpolation continuous operation arc insertion position
28A	30A	38A	40A	48A	50A	58A	60A	
28B	30B	38B	40B	48B	50B	58B	60B	Acc/Dec pattern
28C	30C	38C	40C	48C	50C	58C	60C	M code mode
28D	30D	38D	40D	48D	50D	58D	60D	Detect upper/lower limit during speed control
28E	30E	38E	40E	48E	50E	58E	60E	Positioning complete condition
28F	30F	38F	40F	48F	50F	58F	60F	Interpolation continuous operation positioning method
290	310	390	410	490	510	590	610	2-axis linear interpolation continuous operation arc insertion
291	311	391	411	491	511	591	611	External command select
292	312	392	412	492	512	592	612	External command
293	313	393	413	493	513	593	613	Position specified speed override coordinate
294	314	394	414	494	514	594	614	Infinite running repeat position
295	315	395	415	495	515	595	615	
296	316	396	416	496	516	596	616	Infinite running repeat
297	317	397	417	497	517	597	617	Speed/Position switching coordinate
298	318	398	418	498	518	598	618	Interpolation speed selection
299	319	399	419	499	519	599	619	-
29A	31A	39A	41A	49A	51A	59A	61A	-
29B	31B	39B	41B	49B	51B	59B	61B	-
29C	31C	39C	41C	49C	51C	59C	61C	-
29D	31D	39D	41D	49D	51D	59D	61D	-
29E	31E	39E	41E	49E	51E	59E	61E	-
29F	31F	39F	41F	49F	51F	59F	61F	-

The following is example changing all items of extended parameter with one XSEP command.

If M00000 is on, data set up at D00000 ~ D00024 will be saved at teaching data memory and extended parameter entire setup command will be executed.

734	M00000 P	DMOV	10000000		D00000	Soft upper limit		
		DMOV	-10000000 0		D00002	Soft lower limit		
		MOV	2000		D00005	Positioning complete time		
		MOV	50		D00006	S-curve ratio		
		DMOV	10000		D00007	Comman in-position width		
		DMOV	1000000		D00009	2-axis linear interpolation continuous operation arc insertion position		
		MOV	1		D00011	Acc/Dec pattern		
		MOV	2		D00012	M code mode		
		MOV	1		D00013	Detect upper/lower limit during speed control		
		MOV	3		D00014	Positioning complete condition		
		MOV	1		D00015	Interpolation continuous operation positioning method		
		MOV	1		D00016	2-axis linear interpolation continuous operation arc insertion		
		MOV	1		D00017	External command selection		
		MOV	1		D00018	External command		
		MOV	1		D00019	Position specified speed override coordinate		
		DMOV	1000000		D00020	Infinite running repeat position		
		MOV	1		D00022	Infinite running repeat		
		MOV	1		D00023	Speed/position switching coordinate		
		MOV	1		D00024	Interpolation speed selection		
798	M00000 P	XTWR	2	1	D00000	13	Write multiple teaching	
Block mask	M00000 P	PUT	2	h0280	D00000	26	Write multiple teaching	
806	M00000 P	XSBP	2	1	0	h00FF	0	Set up extended parameter

6.3.34 Set Parameter Of Manual Operation (Command :XSMP)

(1) Program

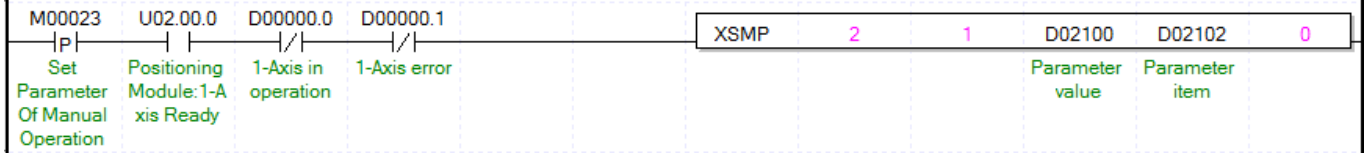

(2) Description

Device	Description
M00023	axis1 manual operation parameter setting input
U02.00.0	axis1 ready
D00000.0	axis1 in operation
D00000.1	axis1 error state
D02100	Parameter value
D02102	Parameter items

Command	XSMP				Manual operation parameter setting
Operand	OP1	Slot	Constant	WORD	Slot No. installed with positioning module
	OP2	Axis	PMLK,constant,D,Z,R,ZR	WORD	Command axis XBF-PN04B: 1axis~4axis XBF-PN08B: 1axis~8axis
	OP3	Parameter value	PMLK,constant,D,Z,R,ZR	DWORD	parameter value to change
	OP4	Parameter item	PMLK,constant,D,Z,R,ZR	WORD	parameter item to change (1~5, 255)
	OP5	Setting method	PMLK,constant,D,Z,R,ZR	WORD	0: RAM setting, 1: ROM setting

※ PMLK means P, M, L and K areas.

- (a) This is the command that changes the value of the item (OP4) which already set among manual operation parameter items to setting value (OP3). In the case of RAM setting by the setting method (OP5), the changed value is maintained during APM module is being connected to power. In the case of ROM setting, it is maintained without the power connection of APM module.
- (b) The number of ROM setting operating is unlimited because manual operation parameter of APM module is saved on MRAM.
- (c) Manual operation parameter setting command is unavailable to be executed when the axis is operating.
- (d) Manual operation parameter items are as follows.

Setting value	Items	Setting value
1	Jog high speed	mm : 1 ~ 2,147,483,647 [$\times 10^{-2}$ mm/min]
		Inch : 1 ~ 2,147,483,647 [$\times 10^{-3}$ Inch/min]
2	Jog low speed	degree : 1 ~ 2,147,483,647 [$\times 10^{-3}$ degree/min]
		pulse : 1 ~ 2,147,483,647 [pulse/sec]
3	Jog acc. time	0 ~ 2,147,483,647 [ms]
4	Jog dec. time	
5	Inching speed	mm : 1 ~ 65,535 [$\times 10^{-2}$ mm/min]
		Inch : 1 ~ 65,535 [$\times 10^{-3}$ Inch/min]
		degree : 1 ~ 65,535 [$\times 10^{-3}$ degree/sec]
		pulse : 1 ~ 65,535 [pulse/sec]

- (e) For the change value (OP3) setting range of each manual operation parameter item (OP4) which already set, refer to "4.3.1 Manual Operation Parameter Content"
- (f) In the example program above, it changes the item that saved on D02102 of axis1 manual operation parameter to the value that saved on D02100 using RAM setting method. In the case of D02102=3, D02100=500, it sets jog acc. time as "500ms" using RAM setting method.

(g) If you want to set up all items of manual operation parameter with one XSMP command, you have to set up hFF(255) at OP4 parameter item. At this time, first, items of manual operation parameter should be saved at multiple teaching memory address below. You can set up data with PUT instruction or XTWR instruction.

Memory address								Contents
1axis	2axis	3axis	4axis	5axis	6axis	7axis	8axis	
280	300	380	400	480	500	580	600	JOG high speed
281	301	381	401	481	501	581	601	
282	302	382	402	482	502	582	602	JOG low speed
283	303	383	403	483	503	583	603	
284	304	384	404	484	504	584	604	JOG acc. time
285	305	385	405	485	505	585	605	
286	306	386	406	486	506	586	606	JOG dec. time
287	307	387	407	487	507	587	607	
288	308	388	408	488	508	588	608	Inching speed
289	309	389	409	489	509	589	609	-
28A	30A	38A	40A	48A	50A	58A	60A	-
28B	30B	38B	40B	48B	50B	58B	60B	-
28C	30C	38C	40C	48C	50C	58C	60C	-
28D	30D	38D	40D	48D	50D	58D	60D	-
28E	30E	38E	40E	48E	50E	58E	60E	-
28F	30F	38F	40F	48F	50F	58F	60F	-
290	310	390	410	490	510	590	610	-
291	311	391	411	491	511	591	611	-
292	312	392	412	492	512	592	612	-
293	313	393	413	493	513	593	613	-
294	314	394	414	494	514	594	614	-
295	315	395	415	495	515	595	615	-
296	316	396	416	496	516	596	616	-
297	317	397	417	497	517	597	617	-
298	318	398	418	498	518	598	618	-
299	319	399	419	499	519	599	619	-
29A	31A	39A	41A	49A	51A	59A	61A	-
29B	31B	39B	41B	49B	51B	59B	61B	-
29C	31C	39C	41C	49C	51C	59C	61C	-
29D	31D	39D	41D	49D	51D	59D	61D	-
29E	31E	39E	41E	49E	51E	59E	61E	-
29F	31F	39F	41F	49F	51F	59F	61F	-

The following is example changing all items of manual operation parameter with one XSMP command.

If M00000 is on, data set up at D00000 ~ D00008 will be saved at teaching data memory and manual operation parameter entire setup command will be executed.

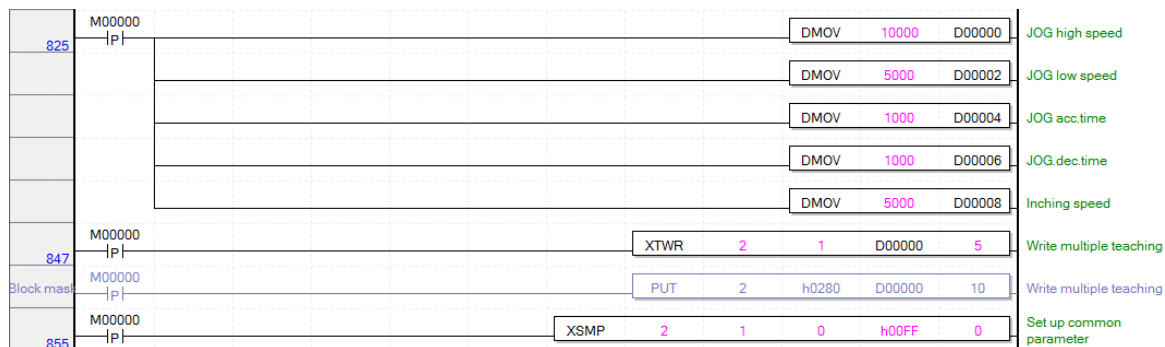

6.3.35 Input signal parameter teaching (Command : XSES)

(1) Program

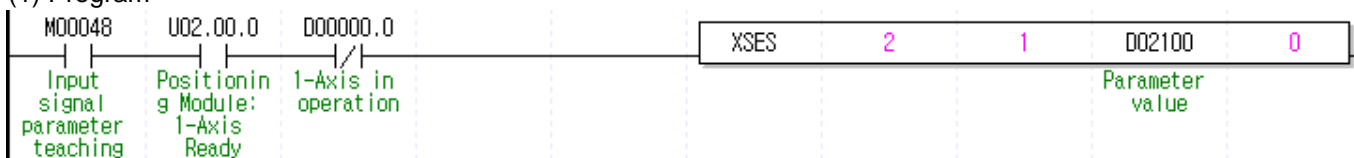

(2) Description

Device	Description
M00048	1axis parameter setting of the input signal
U02.00.0	1axis operation ready
D00000.0	1 axis signal in operation
D02100	Parameter value

Command	XSES				Set input signal parameter
Operand	OP1	Slot	Constant	WORD	Slot No. installed with positioning module
	OP2	Axis	PMLK,Constant,D, Z,R,ZR	WORD	Command axis XBF-PN04B: 1axis~4axis XBF-PN08B:1axis~8axis
	OP3	Parameter value	PMLK,Constant,D, Z,R,ZR	WORD	parameter value to change
	OP4	Setting method	PMLK,Constant,D, Z,R,ZR	WORD	0: RAM setting, 1: ROM setting

※ PMLK means P, M, L and K areas.

- (a) It is a command to change to set the parameters of the input signal of the axis (OP3). In case of setting method(OP4), If you have a set of RAM, changed value is maintained during power on. If you have a set of ROM, changed value is maintained during power off.
- (b) Input signal parameters of the positioning module, because they are stored in the MRAM, the number of executions of the ROM of setting there is no limit.
- (c) Command to set the parameters of the input signal, if the axis is in operation can not be performed.

(d) The meaning of each bit of the parameter setting value of the input signal is as follows.

15	14	13	12	11 ~ 8	7 ~ 4	3 ~ 0
-	Logic selection of input signal Z	Logic selection of input signal B	Logic selection of input signal A	Function selection of input signal Z	Function selection of input signal B	Function selection of input signal A

(e) Setting value of each item are as follows.

Item of input signal parameter	Range
Function selection of input signal A	0: Unused 1: Switching speed/position control 2: Switching position/torque control 3: External operation
Function selection of input signal B	
Function selection of input signal Z	
Logic selection of input signal A	A Contact, B Contact
Logic selection of input signal B	
Logic selection of input signal Z	
Switching torque of external position/torque control	-32768 ~ 32767

(f) The above sample program, is to change the input signal parameters of one axis to the value stored in D02100. For D02100 = h0123, the input signal A "3: External start", the input signal B is "2: Switching position / torque control", the input signal Z is 1: Switching Speed / position control "is set in the function you.

6.3.36 Input signal parameter – Switching torque of external position/torque control teaching (Command : XSEST)

(1) Program

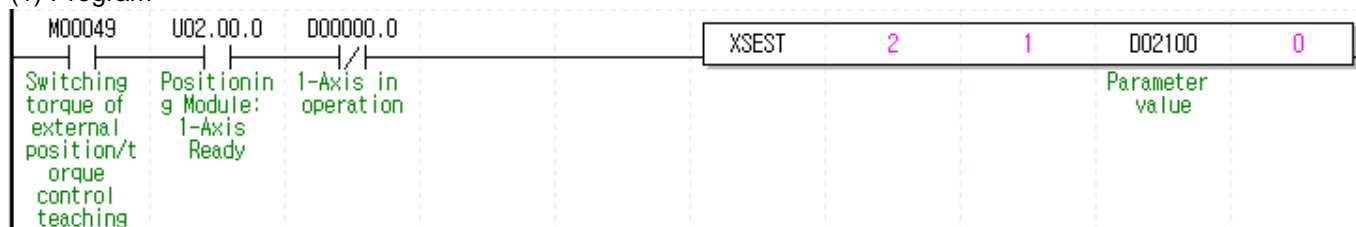

(2) Description

Device	Description
M00049	1axis Switching torque of external position/torque control teaching
U02.00.0	1axis operation ready
D00000.0	1 axis signal in operation
D02100	Parameter value

Command	XSEST				Switching torque of external position/torque control teaching
Operand	OP1	Slot	Constant	WORD	Slot No. installed with positioning module
	OP2	Axis	PMLK,Constant,D,Z,R,ZR	WORD	Command axis XBF-PN04B: 1axis~4axis XBF-PN08B:1axis~8axis
	OP3	Torque value	PMLK,Constant,D,Z,R,ZR	INT	Switching position/Torque control torque value to change
	OP4	Setting method	PMLK,Constant,D,Z,R,ZR	WORD	0: RAM, 1: ROM

※ PMLK means P, M, L and K areas.

- It is a command to change to the 'external location / torque control switching torque' setting (OP3) in the parameter of the input signal of the axis. In case of setting method(OP4), If you have a set of RAM, changed value is maintained during power on. If you have a set of ROM, changed value is maintained during power off.
- Input signal parameters of the positioning module, because they are stored in the MRAM, the number of executions of the ROM of setting there is no limit.
- Command of Switching torque of external position/torque control teaching, if the axis is in operation can not be performed.
- Setting range of torque values are as follows.
-32768 % ~ 32767 %
- The above sample program, is to change the input signal parameters of one axis to the value stored in D02100. If D02100 = 5, the torque value of the switching of the external position / torque control is set to 5%.

6.3.37 Set Common Parameter (Command : XSCP)

(1) Program

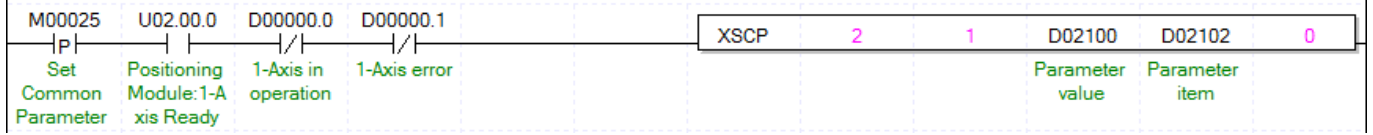

(2) Description

Device	Description
M00025	Common parameter setting input
U02.00.0	axis1 ready
D02100	Parameter value
D02102	Parameter items

Command	XSCP				Common parameter Setting
Operand	OP1	Slot	Constant	WORD	Slot No. installed with positioning module
	OP2	Axis	PMLK,constant,D,Z,R,ZR	WORD	Command axis XBF-PN04B: 1axis~4axis XBF-PN08B: 1axis~8axis
	OP3	Parameter value	PMLK,constant,D,Z,R,ZR	DINT	parameter value to change
	OP4	Parameter item	PMLK,constant,D,Z,R,ZR	WORD	Parameter item to change (1~5,10~11,255)
	OP5	Setting Method	PMLK,constant,D,Z,R,ZR	WORD	0: RAM setting, 1: ROM setting

※ PMLK means P, M, L and K areas.

- (a) This is the command that changes the value of the item (OP4) which already set among common parameter items to setting value (OP3). In the case of RAM setting by the setting method (OP5), the changed value is maintained during positioning module is being connected to power. In the case of ROM setting, it is maintained without the power connection of positioning module.
- (b) The number of ROM setting operating is unlimited because common parameter of APM module is saved on MRAM.

(c) The value to be set in parameter item is as follows.

Setting value	Items	Setting value
1	Speed override method	0: % setting 1: Speed setting
2	Encoder1 pulse input mode	0:CW/CCW 1X 1:PULSE/DIR 1X 2:PULSE/DIR 2X 3:PHASE A/B 1X 4:PHASE A/B 2X 5:PHASE A/B 4X
3	Encoder1 max. value	-2147483648 ~ 2147283647
4	Encoder1 min. value	
5	Encoder1 Z phase clear	0: disable, 1:enable
10	Destination coordinates for positioning speed synchronization	0:incremental, 1:absolute,
11	Encoder 1 average number	0:None 1: 5 2:10 3:20
13	Function selection of external input terminal	0: A,B,Z phase of encoder signal 1: External input signal A,B,Z
14	Input filter of external input signal	0: Disable, 1: Enable

(d) For the change value (OP3) setting range of each common parameter item (OP4) which already set, refer to "4.6.1 Common Parameter Content"

(e) In the example program above, it changes the item that saved on D02102 of common parameter to the value that saved on D02100 using RAM setting method. In the case of D02102=1, D02100=1, it sets speed override method time as "1: speed setting" using RAM setting method.

(f) If you want to set up all items of common parameter with one XSCP command, you have to set up hFF(255) at OP4 parameter item. At this time, first, items of common parameter should be saved at multiple teaching memory address below. You can set up data with PUT instruction or XTWR instruction.

Memory address								Contents
1axis	2axis	3axis	4axis	5axis	6axis	7axis	8axis	
280	300	380	400	480	500	580	600	Speed override
281	301	381	401	481	501	581	601	Encoder1 pulse input
282	302	382	402	482	502	582	602	Encoder1 max. value
283	303	383	403	483	503	583	603	
284	304	384	404	484	504	584	604	Encoder1 min. value
285	305	385	405	485	505	585	605	
286	306	386	406	486	506	586	606	Encoder1 Z-phase clear
287	307	387	407	487	507	587	607	Destination coordinates for positioning speed synchronization
288	308	388	408	488	508	588	608	Encoder 1 average number
289	309	389	409	489	509	589	609	Function selection of external input terminal
28A	30A	38A	40A	48A	50A	58A	60A	Input filter of external input signal
28B	30B	38B	40B	48B	50B	58B	60B	
28C	30C	38C	40C	48C	50C	58C	60C	
28D	30D	38D	40D	48D	50D	58D	60D	-
28E	30E	38E	40E	48E	50E	58E	60E	-
28F	30F	38F	40F	48F	50F	58F	60F	-
290	310	390	410	490	510	590	610	-
291	311	391	411	491	511	591	611	-
292	312	392	412	492	512	592	612	-
293	313	393	413	493	513	593	613	-
294	314	394	414	494	514	594	614	-
295	315	395	415	495	515	595	615	-
296	316	396	416	496	516	596	616	-
297	317	397	417	497	517	597	617	-
298	318	398	418	498	518	598	618	-
299	319	399	419	499	519	599	619	-
29A	31A	39A	41A	49A	51A	59A	61A	-
29B	31B	39B	41B	49B	51B	59B	61B	-
29C	31C	39C	41C	49C	51C	59C	61C	-
29D	31D	39D	41D	49D	51D	59D	61D	-
29E	31E	39E	41E	49E	51E	59E	61E	-
29F	31F	39F	41F	49F	51F	59F	61F	-

The following is example changing all items of common parameter with one XSCP command.

If M00000 is on, data set up at D00000 ~ D00020 will be saved at teaching data memory and common parameter entire setup command will be executed.

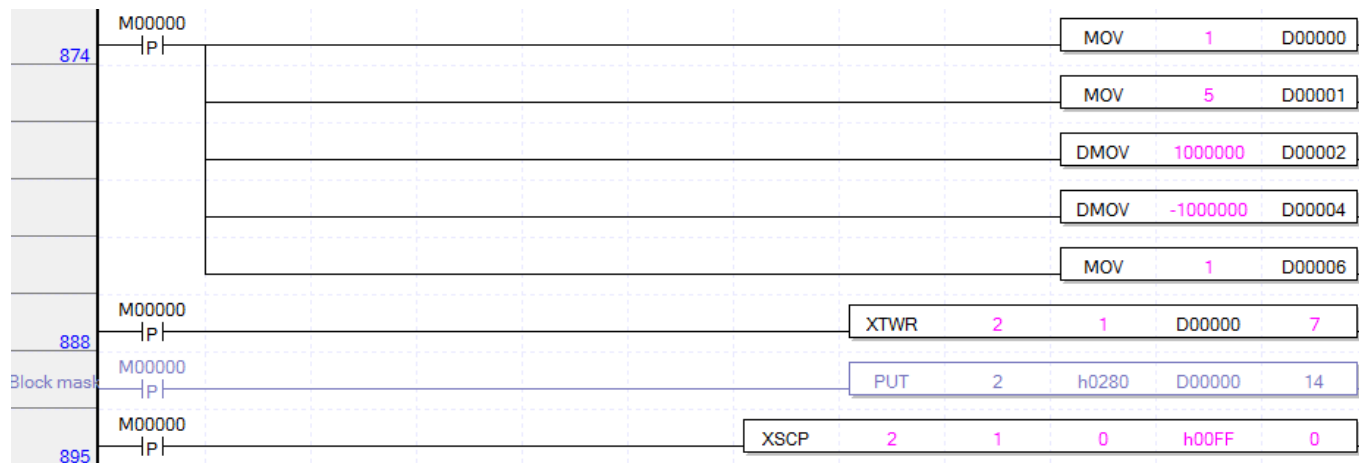

6.3.38 Set Operation Data (Command: XSMD)

(1) Program

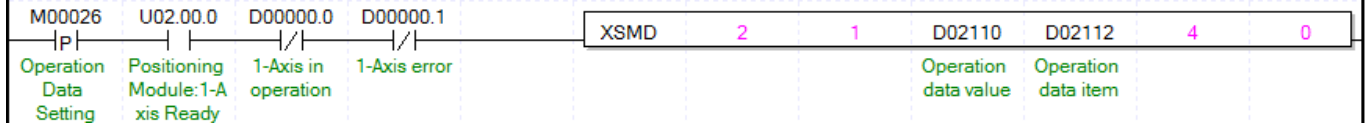

(2) Description

Device	Description
M00026	axis1 Operation data setting input
U02.00.0	axis1 ready
D00000.0	axis1 I in operation
D00000.1	axis1 error state
D02110	Operation data value
D02112	Operation data items

Command	XSMD				Operation data setting
	OP	Slot	Constant	WORD	
Operand	OP 1	Slot	Constant	WORD	Slot No. installed with positioning module
	OP 2	Axis	PMLK,constant,D,Z,R,Z R	WORD	Command axis XBF-PN04B: 1axis~4axis XBF-PN08B:1axis~8axis
	OP 3	Operation data value	PMLK,constant,D,Z,R,Z R	DINT	Operation data value to change
	OP 4	Operation data item	PMLK,constant,D,Z,R,Z R	WORD	Operation data item (1~17, 255)
	OP 5	Step No.	PMLK,constant,D,Z,R,Z R	WORD	Operation data step No. to change (0~400)
	OP 6	Step method	PMLK,constant,D,Z,R,Z R	WORD	0: RAM setting, 1: ROM setting

※ PMLK means P, M, L and K areas.

- (a) This is the command that changes the item (OP4) of a step which already set on OP5 among operation data items to setting value (OP3). In the case of RAM setting by the setting method (OP6), the changed value is maintained during positioning module is being connected to power. In the case of ROM setting, it is maintained without the power connection of positioning module.
- (b) The number of ROM setting operating is unlimited because operation data of positioning module is saved on MRAM.
- (c) Operation data setting command is available to be executed when the axis is operating. However, if operation data of the step that is currently operated are changed, those changes are reflected after the current step is completed.

(d) The values to be set in operation data item are as follows

Setting value	Items	Setting value														
1	Target position	mm : -2147483648 ~ 2147483647 [$\times 10^{-4}$ mm] Inch : -2147483648 ~ 2147483647 [$\times 10^{-5}$ Inch] degree : -2147483648 ~ 2147483647 [$\times 10^{-5}$ degree] pulse : -2147483648 ~ 2147483647 [pulse]														
2	Circular interpolation auxiliary position															
3	Operation speed	mm : 1 ~ 2,147,483,647 [$\times 10^{-2}$ mm/min] Inch : 1 ~ 2,147,483,647 [$\times 10^{-3}$ Inch/min] degree : 1 ~ 2,147,483,647 [$\times 10^{-3}$ degree/min] pulse : 1 ~ 2,147,483,647 [pulse/sec]														
4	Dwell time	0 ~ 65,535[ms]														
5	M code No.	0 ~ 65,535														
6	Sub axis setting	Bit unit setting														
		<table border="1"> <thead> <tr> <th>Bit 7</th> <th>Bit 6</th> <th>Bit 5</th> <th>Bit 4</th> <th>Bit 3</th> <th>Bit 2</th> <th>Bit 1</th> <th>Bit 0</th> </tr> </thead> <tbody> <tr> <td>8axis</td> <td>7axis</td> <td>6axis</td> <td>5axis</td> <td>axis4</td> <td>axis3</td> <td>axis2</td> <td>axis1</td> </tr> </tbody> </table>	Bit 7	Bit 6	Bit 5	Bit 4	Bit 3	Bit 2	Bit 1	Bit 0	8axis	7axis	6axis	5axis	axis4	axis3
Bit 7	Bit 6	Bit 5	Bit 4	Bit 3	Bit 2	Bit 1	Bit 0									
8axis	7axis	6axis	5axis	axis4	axis3	axis2	axis1									
7	Helical interpolation axis	0, axis1 ~ axis8 (0: General circular arc interpolation)														
8	Circular interpolation turns	0~65,535														
9	Coordinate	0:absolute, 1:incremental														
10	Control method	0:Single axis position control, 1:,Single axis speed control 2:Single-axis Feed control, 3:Linear interpolation, 4:Circular arc interpolation														
11	Operation method	0:Single, 1:Repeat														
12	Operation Pattern	0:End, 1:Keep, 2:Continuous														
13	Circular arc size	0:Circular arc<180 1:Circular arc>=180														
14	Acc. No.	0 ~ 3														
15	Dec. No.	0 ~ 3														
16	Circular arc interpolation method	0:Middle point, 1:Center point, 2:Radius														
17	Circular arc interpolation direction	0:CW, 1:CCW														

(e) For the change value (OP3) setting range of each position data item (OP4) which already set, refer to “4.7.1 Operation Data Content”

(f) In the example program above, it changes the item that saved on D02112 of axis1 operation to the value that saved on D02100 using RAM setting method. In the case of D02112=5, D02100=125, it changes M code no. of step no.4 to “125” using RAM setting method.

(g) If you want to set up all items of position data with one XSCP command, you have to set up hFF(255) at OP4 parameter item. At this time, first, items of position data should be saved at multiple teaching memory address below. You can set up data with PUT instruction or XTWR instruction.

Memory address								Contents
1axis	2axis	3axis	4axis	5axis	6axis	7axis	8axis	
280	300	380	400	480	500	580	600	Target position
281	301	381	401	481	501	581	601	
282	302	382	402	482	502	582	602	Circular interpolation auxiliary position
283	303	383	403	483	503	583	603	
284	304	384	404	484	504	584	604	Operation speed
285	305	385	405	485	505	585	605	
286	306	386	406	486	506	586	606	Dwell time
287	307	387	407	487	507	587	607	M code number
288	308	388	408	488	508	588	608	Sub-axis setting
289	309	389	409	489	509	589	609	Helical interpolation axis
28A	30A	38A	40A	48A	50A	58A	60A	Circular interpolation turns
28B	30B	38B	40B	48B	50B	58B	60B	Coordinate
28C	30C	38C	40C	48C	50C	58C	60C	Control type
28D	30D	38D	40D	48D	50D	58D	60D	Operation type
28E	30E	38E	40E	48E	50E	58E	60E	Operation pattern
28F	30F	38F	40F	48F	50F	58F	60F	Arc size
290	310	390	410	490	510	590	610	Acc. No.
291	311	391	411	491	511	591	611	Dec. No.
292	312	392	412	492	512	592	612	Circular interpolation mode
293	313	393	413	493	513	593	613	Circular interpolation direction
294	314	394	414	494	514	594	614	-
295	315	395	415	495	515	595	615	-
296	316	396	416	496	516	596	616	-
297	317	397	417	497	517	597	617	-
298	318	398	418	498	518	598	618	-
299	319	399	419	499	519	599	619	-
29A	31A	39A	41A	49A	51A	59A	61A	-
29B	31B	39B	41B	49B	51B	59B	61B	-
29C	31C	39C	41C	49C	51C	59C	61C	-
29D	31D	39D	41D	49D	51D	59D	61D	-
29E	31E	39E	41E	49E	51E	59E	61E	-
29F	31F	39F	41F	49F	51F	59F	61F	-

The following is example changing all items of first step of position data with one XSMD command.
 If M00000 is on, data set up at D00000 ~ D00008 will be saved at teaching data memory and position data entire setup command will be executed.

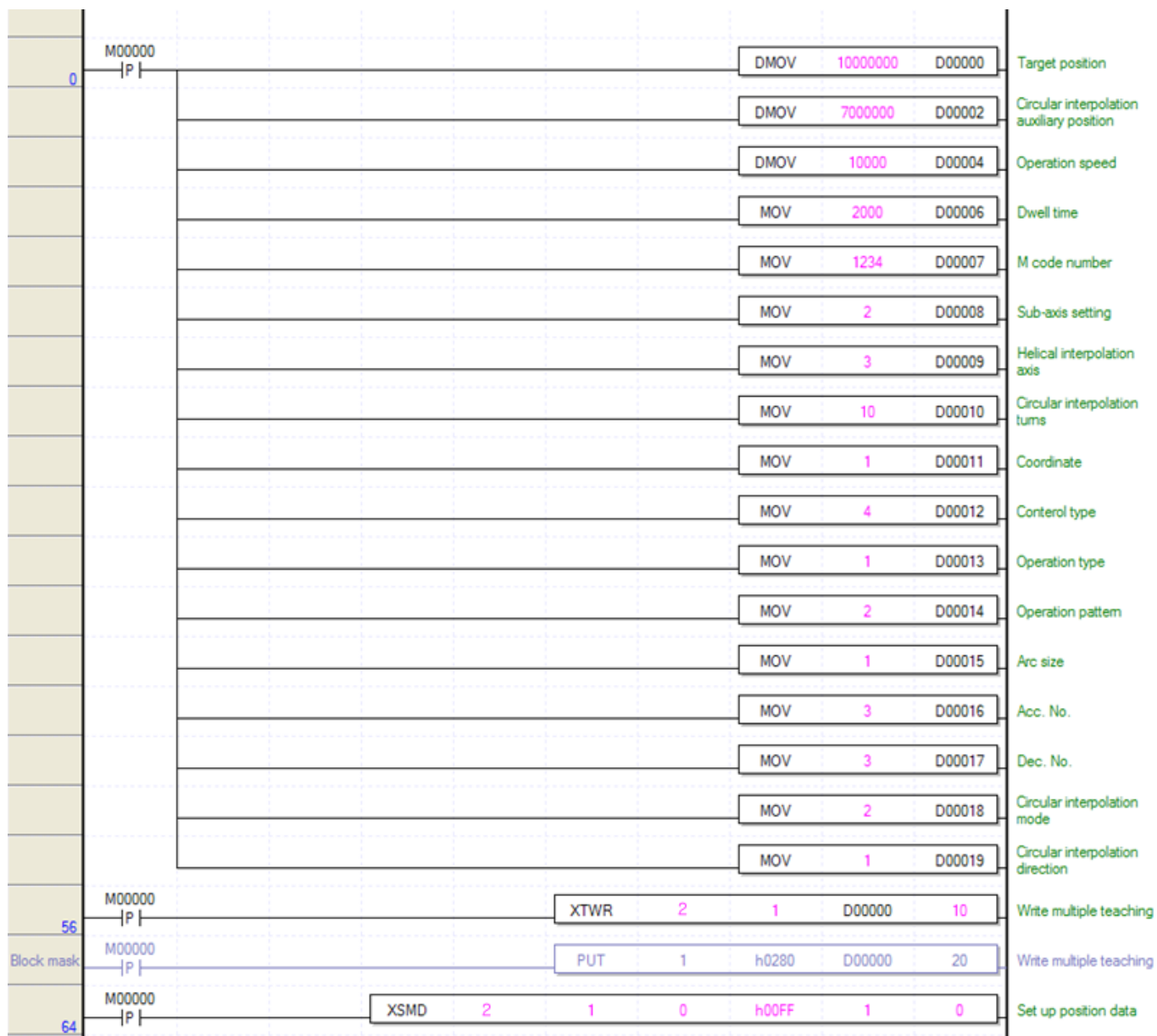

6.3.39 Read Variable Data (Command: XVRD)

(1) Program

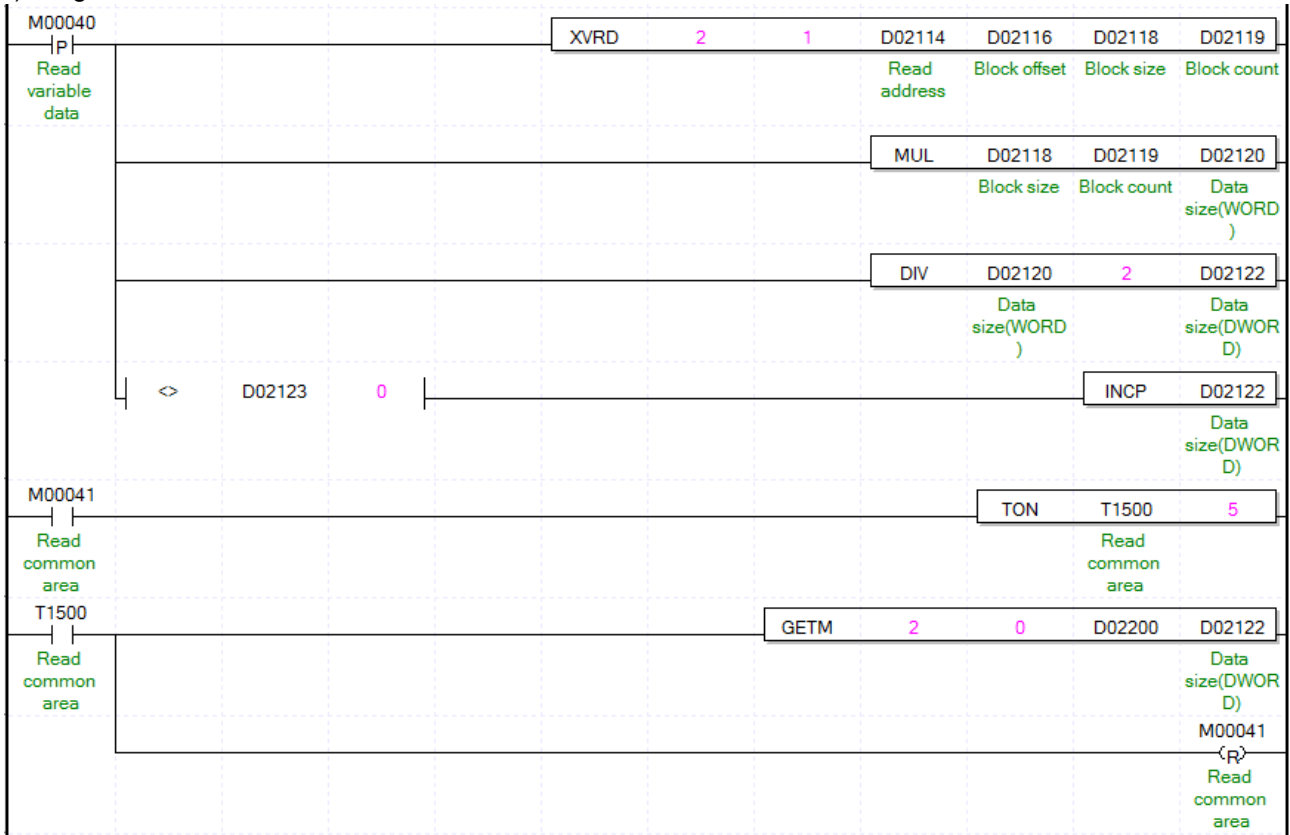

(2) Description

Device	Description
M00040	Input to read variable data
M00041	Ready flag to read common area (ready flag to save in internal device by GETM after executing command reading variable data)
D02114	Head address to read internal memory data of module
D02116	Block offset
D02118	Block size
D02119	Number of block
D02120	Size of data to read (WORD)
D02122	Size of data to read (DWORD)
D02123	Remaining (after changing WORD to DWORD)
D02200	Head device to save data

Command	XVRD				Read variable data
Operand	OP1	Slot	Constant	WORD	Base and slot number where positioning module is equipped
	OP2	Axis	PMLK,constant,D,Z,R,ZR	WORD	Command axis XBF-PN04B: 1axis~4axis XBF-PN08B:1axis~8axis
	OP3	Read address	PMLK,constant,D,Z,R,ZR	DWORD	Head address of data in module internal memory to read (0 ~72793)
	OP4	Block offset	PMLK,constant,D,Z,R,ZR	DWORD	Offset between blocks (0 ~72793)
	OP5	Block size	PMLK,constant,D,Z,R,ZR	WORD	Size of one block (1 ~ 128)
	OP6	No. of block	PMLK,constant,D,Z,R,ZR	WORD	No. of block to read (1 ~ 128)

※ PMLK indicates P area, M area, L area, K area.

- (a) This is command that reads data among parameter, operating data, CAM data by WORD unit from “Read address” into CPU. The number of data is set in “Block size”. In case “No. of block” set in OP6 is more than 2, it reads multiple blocks. At this time, head address of next block is “Block offset” apart from head address of current block.
- (b) Max data size (Block size X No. of block) can be read with one command is 128 WORD.
- (c) “Read variable data” can be executed in operation.
- (d) If you execute “Read variable data”, the data read from positioning module will be saved in common area. In order to save in device for using in program, use GETM command [Read address: h280, data size: read data size (DWORD) as program example after executing “Read variable data” command
- (e) In the above program, it reads data starting “Read address” set in D02114 by WORD unit into CPU. The number of data is “D02118”. In case “No. of block set in D02119 is more than 2, it reads multiple blocks starting “Read address” D02114 in order. In the above program, saves the read data in D02200 5ms after executing “Read variable data: command. You have to execute GETM command minimum 4ms after executing “Read variable data” to save the read data in common area.
- (f) Don't use XVRD command at the same time. That is, you must execute a command after the other command's operation completes. Please note that the command don't execute at the same time in case the command axis is same or different.

6.3.40 Write Variable Data (Command: XVWR)

(1) Program

M00042			XVWR	2	1	D02400	D02124	D02116	D02118	D02119
P						Save device	Write address	Block offset	Block size	Block count
Write Variable Data										

(2) Comment

Device	Description
M00042	Input to write variable data
D2400	Head address where data for writing is saved
D2124	Write address
D2116	Block offset
D2118	Block size
D2119	No. of block

Command	XVWR				Write variable data
Operand	OP 1	Slot	Constant	WORD	Base and slot number where positioning module is equipped
	OP 2	Axis	PMLK,constant,D,Z, R,ZR	WORD	Command axis XBF-PN04B: 1axis~4axis XBF-PN08B:1axis~8axis
	OP 3	Data device	PMLK,constant,D,Z, R,ZR	WORD	Head address where data to write is saved.
	OP 4	Write address	PMLK,constant,D,Z, R,ZR	DWORD	Head address to write module internal memory data (0 ~72768)
	OP 5	Block offset	PMLK,constant,D,Z, R,ZR	DWORD	Offset between blocks (0 ~ 72768)
	OP 6	Block size	PMLK,constant,D,Z, R,ZR	WORD	Size of one block (1 ~ 128)
	OP 7	No. of block	PMLK,constant,D,Z, R,ZR	WORD	No. of block to read (1 ~ 128)

※ PMLK indicates P area, M area, L area, K area.

- (a) This is command that writes data starting “Write address” set in OP4 among parameter of positioning module internal memory, operation data, CAM data to internal memory address starting OP3. The number of data to write is “Block size” OP6. In case “No. of block” is more than 2, writes multiple blocks. At this time, head address of next block is “Block offset” OP5 apart from head address of current block.
- (b) Max data size (Block size X No. of block) that can be written with one command is 128 WORD.
- (c) Even “Write variable data” command can be executed even when the axis subject to teaching is being operated but, only the current step’s data is reflected after the current step operation is completed if the step that is currently running is within the step area while other steps’ data are immediately changed.
- (d) In case you execute “Write variable data”, the changed value is kept during power on. So, to save the data, execute “Save Parameter/Operation data (XWRT) command.
- (e) In the above program example, writes data starting from D02400 to internal memory address starting from “D2124” in order by WORD unit. The number of data is “Block size”. In case “No. of Block” set in D02119 is larger than 2, writes multiple blocks. At this time, head address of next block is “Block offset” OP5 apart from head address of current block.
- (f) Don’t use XVWR command at the same time. That is, you must execute a command after the other command’s operation completes. Please note that the command don’t execute at the same time in case the command axis is same or different.

6.3.41 Save Parameter/Operation Data (Command : XWRT)

(1) Program

M00027	U02.00.0	D00000.1	XWRT	2	1	h0013
P		/				
Save Parameter/ Operation Data	Positioning Module:1-A axis Ready	1-Axis error				

(2) Description

Device	Description
M00027	axis1 parameter/operation data save input
U02.00.0	axis1 ready
D00000.1	axis1 error state

Command	XWRT				Parameter/operation Data save
Operand	OP1	Slot	Constant	WORD	Slot No. installed with positioning module
	OP2	Axis	PMLK,constant,D,Z,R,ZR	WORD	Command axis XBF-PN04B: 1axis~4axis XBF-PN08B: 1axis~8axis
	OP3	Selection axis	PMLK,constant,D,Z,R,ZR	WORD	Axis to save data

※ PMLK means P, M, L and K areas.

- This is the command that saves the parameter data & operation data of selected axis on MRAM.
- The current parameter & operation data of selected axis will be saved on MRAM, it is also maintained when the power is off.
- The number of parameter/operation data save command is unlimited.
- Parameter/operation data save command is available to be executed when the axis is operating. Execute it when all axes are not in operation.
- Set the selection axis by setting each bit of axis.

15 ~ 8 Bit	7Bit	6Bit	5Bit	4Bit	3Bit	2Bit	1Bit	0Bit
Not use	Axis8	Axis7	Axis6	Axis5	Axis4	Axis3	Axis2	axis1

That is, if set h0003, axis2, axis1 will be set to execute parameter/operation data save.

- In the example program above, save parameter/operation data of 1, axis2 on MRAM.
- In case of changing CAM data with Write variable data command(XVWR), changed CAM data is saved at Flash during XWRT operation.

6.3.42 Emergency Stop (Command : XEMG)

(1) Program

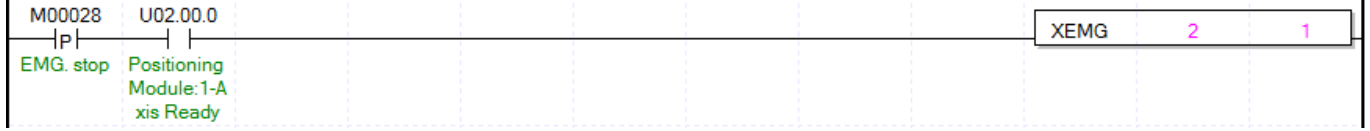

(2) Description

Device	Description
M00028	axis1 internal emergency stop input
U02.00.0	axis1 ready

Command	XEMG				Emergency stop
Operand	OP1	Slot	Constant	WORD	Slot No. installed with positioning module
	OP2	Axis	PMLK,constant,D,Z,R,ZR	WORD	Command axis XBF-PN04B: 1axis~4axis XBF-PN08B:1axis~8axis

※ PMLK means P, M, L and K areas.

- (a) Execute internal emergency stop command to command axis.
- (b) Dec. time in emergency stop become the time which set on “Emergency stop dec. time” item of each basic parameter.
- (c) The example program above is the command stop axis1 emergently.

6.3.43 Reset Error (Command : XCLR)

(1) Program

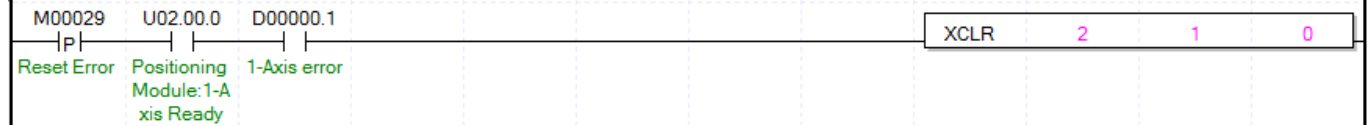

(2) Description

Device	Description
M00029	axis1 error reset input
U02.00.0	axis1 ready
D00000.1	axis1 error state

Command	XCLR				Error reset
Operand	OP1	Slot	Constant	WORD	Slot No. installed with positioning module
	OP2	Axis	PMLK,constant,D,Z,R,ZR	WORD	Command axis XBF-PN04B: 1axis~4axis XBF-PN08B:1axis~8axis
	OP3	Common error	PMLK,constant,D,Z,R,ZR	WORD	0: reset axis error, 1: reset common error

※ PMLK means P, M, L and K areas.

- (a) This is the command that reset the error occurred on command axis.
- (b) In case of common error, not axis error, execute the command while common error item (OP3) is 1.
- (c) The example program above is that reset the error occurred on axis1.

6.3.44 Reset Error History (Command : XECLR)

(1) Program

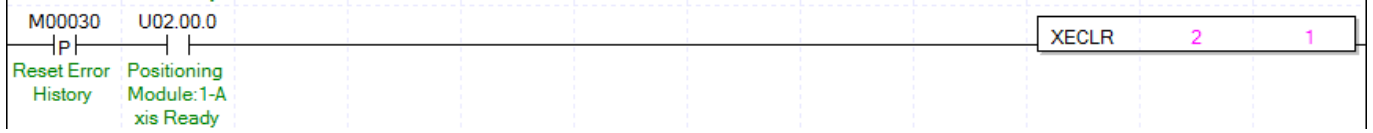

(2) Description

Device	Description
M00030	axis1 error history reset input
U02.00.0	axis1 ready

Command	XECLR				Error History Reset
Operand	OP1	Slot	Constant	WORD	Slot No. installed with positioning module
	OP2	Axis	PMLK,constant,D,Z,R,ZR	WORD	Command axis XBF-PN04B: 1axis~4axis XBF-PN08B:1axis~8axis

※ PMLK means P, M, L and K areas.

- (a) This is the command that reset the error history about command axis.
- (b) The module in each axis saves 10 (Maximum) error histories.
- (c) The example program above is that reset errors occurred on axis1.

6.3.45 Point Start (Command : XPST)

(1) Program

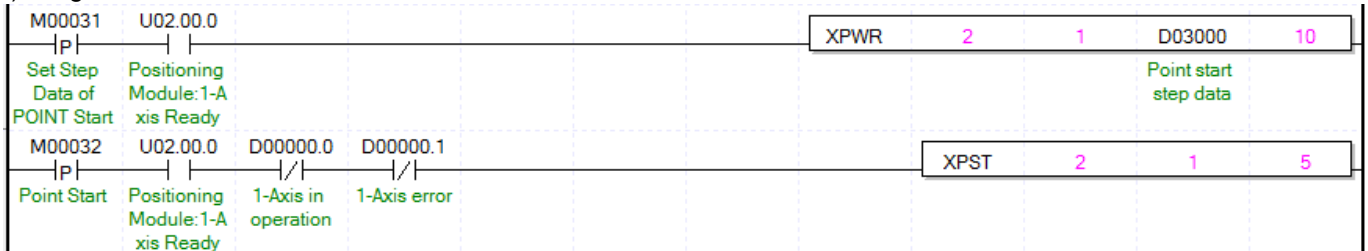

(2) Description

Device	Description
M00031	axis1 point start step data setting input
M00032	axis1 point start input
U02.00.0	axis1 ready
D00000.0	axis1 operating state
D00000.1	axis1 error state
D03000	Point start step data setting leading device

Command	XPST				Point operation
Operand	OP1	Slot	Constant	WORD	Slot No. installed with positioning module
	OP2	Axis	PMLK,constant,D,Z,R,ZR	WORD	Command axis XBF-PN04B: 1axis~4axis XBF-PN08B:1axis~8axis
	OP3	Point operation No.	PMLK,constant,D,Z,R,ZR	WORD	Point operation step No. (1~20)

※ PMLK means P, M, L and K areas.

- (a) This is the command that execute point start of command axis.
- (b) It is unavailable to be executed when the axis is operating.
- (c) It is able to set maximum 20 point start step.
- (d) Step data must be set in point start data area before execute point start. For the point start step data setting, refer to the next page about XPWR command.
- (d) For the detail description about operation of point start, refer to "9.2.18 positioning start (4) Point start".
- (f) The example program sets 10 point steps from D03000 on axis1 and executes point start to 5 point step which already set.

6.3.46 Set Step Data of POINT Start (Command: XPWR)

(1) Program

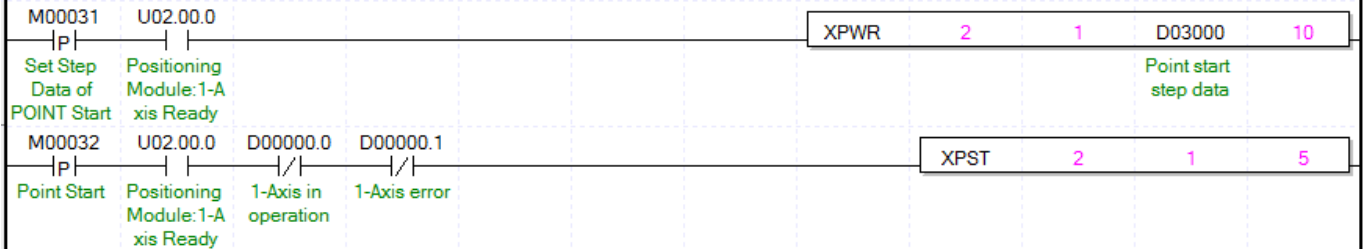

(2) Description

Device	Description
M00031	axis1 Point Start Step Data Setting Input
M00032	axis1 Point Start Input
U02.00.0	axis1 ready
D00000.0	axis1 Operating State
D00000.1	axis1 Error State
D03000	Point Start Step Data Setting Leading Device No.

Command	XPWR			POINT Start Step Data Setting	
	OP1	Slot	Constant	WORD	Slot No. installed with positioning module
Operand	OP2	Axis	PMLK,constant,D,Z,R,ZR	WORD	Command axis XBF-PN04B: 1axis~4axis XBF-PN08B:1axis~8axis
	OP3	Device	PMLK,D,Z,R,ZR	WORD	Leading No. of device with POINT Start Step Data
	OP3	Data No.	PMLK,constant,D,Z,R,ZR	WORD	Data No. to save (1 ~ 20)

※ PMLK means P, M, L and K areas.

(a) This is the command that sets step which set on device of point step area of command axis.

(b) Point start won't be executed by only point start step data setting command. Refer to the previous page about PST command.

(c) It is able to set maximum 20 point start step.

(d) Point start step data will be set like item below depending on the leading no. of device.

No.	Device No.	POINT start step data
1	Device + 0	POINT start step data 1
2	Device + 1	POINT start step data 2
3	Device + 2	POINT start step data 3
4	Device + 3	POINT start step data 4
5	Device + 4	POINT start step data 5
6	Device + 5	POINT start step data 6
7	Device + 6	POINT start step data 7
8	Device + 7	POINT start step data 8
9	Device + 8	POINT start step data 9
10	Device + 9	POINT start step data 10
11	Device + 10	POINT start step data 11
12	Device + 11	POINT start step data 12
13	Device + 12	POINT start step data 13
14	Device + 13	POINT start step data 14
15	Device + 14	POINT start step data 15
16	Device + 15	POINT start step data 16
17	Device + 16	POINT start step data 17
18	Device + 17	POINT start step data 18
19	Device + 18	POINT start step data 19
20	Device + 19	POINT start step data 20

(e) Step data must be set in point start data area before execute point start.

(f) For detail description of point start operation, refer to “9.2.18 Positioning Start (4) Point Start”.

(g) The example program above sets 10 point steps from D03000 on axis1 and executes point start to 5 point steps which already set.

(h) It is possible to set point operation step with PUT command. At that time, refer to memory address of “5.1.1 Point Operation Step Data” and “6.1.2 Internal Memory Writing”. If apply PUT to the example program above, refer to follows.

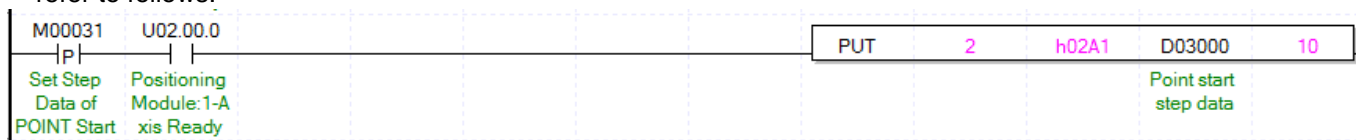

6.3.47 Read Operation State (Command: XSRD)

(1) Program

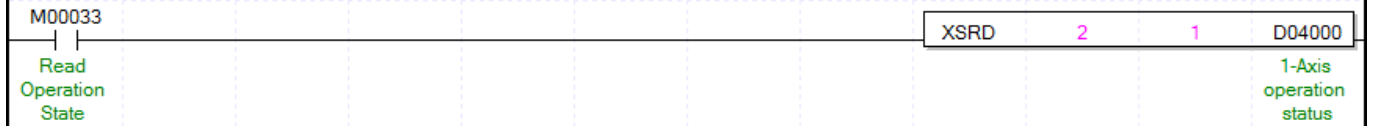

(2) Description

Device	Description
M0033	axis1 operation state reading input
D04000	Head address to save the operation status of axis 1

Command	XSRD				Operation state reading
Operand	OP1	Slot	Constant	WORD	Slot No. installed with positioning module
	OP2	Axis	PMLK,constant,D,Z,R,ZR	WORD	Command axis XBF-PN04B: 1axis~4axis XBF-PN08B:1axis~8axis
	OP3	Device	PMLK,D,Z,R,ZR	WORD	Leading No. of device to save the current state value

※ PMLK means P, M, L and K areas.

- (a) This is the command that checks the operation state of command axis and save it on designated device.
- (b) The current state will be saved like items below depending on leading no. of device.

Device No.	Size	State
Device	WORD	Operation State Information (Up)
Device + 1	WORD	Operation State Information (Down)
Device + 2	WORD	Axis Information
Device + 3	WORD	External Input/Output Signal State
Device + 4	DINT	Current Position
Device + 6	DWORD	Current Speed
Device + 8	WORD	Step No.
Device + 9	WORD	M Code No.
Device + 10	WORD	Error state
Device + 11 ~ Device + 17	WORD	Error History 1 ~ 7
Device + 18	WORD	Error History 8 External input signal low
Device + 19	WORD	Error History 9 External input signal high
Device + 20	WORD	Servo error information
Device + 21	DINT	Encoder1 value
Device + 23	DINT	Encoder2 value
Device + 25	DINT	Command position
Device + 27	DWORD	Command speed
Device + 29	WORD	Torque
Device + 30	WORD	Common error information

- (c) It is able to read the current state of axis with GET command. At this time, refer to memory address of “5.1.4 State Information” and “6.1.1 Internal Memory Reading”. If use GET command in the example above, it is as follows. In addition, it is able to read the states that you need with GET command.

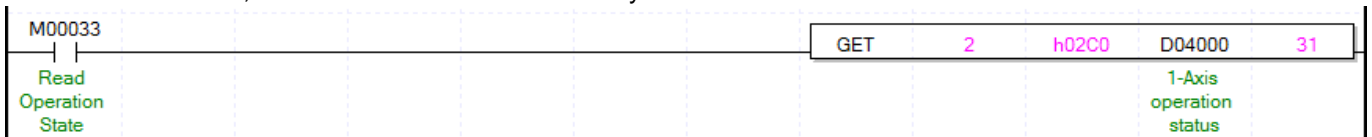

6.3.48 Connect servo (Command: XECON)

(1) Program

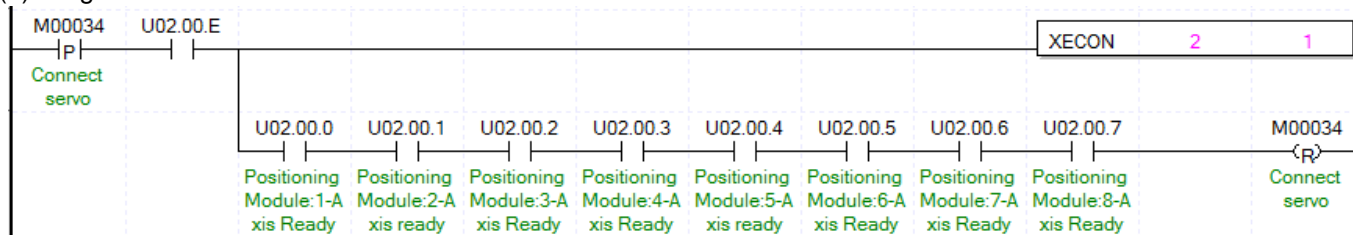

(2) Description

Device	Description
M0034	Servo connection input
U02.00.E	Link up/down information

Command	XECON				Servo Connection	
Operand	OP1	Slot	Constant	WORD	Slot No. installed with positioning module	
	OP2	Axis	PMLK,constant,D,Z,R,ZR	WORD	Command axis XBF-PN04B: 1axis~4axis XBF-PN08B:1axis~8axis	

※ PMLK means P, M, L and K areas.

- (a) This is the command that connects the communication between the positioning module and the servo driver connected to that module through Ethernet cable.
- (b) If servo drive is connected normally, a bit corresponding to the connected axis of U device will be set.

Axis	Signal direction: PLC CPU ← Positioning module	
	Input signal	Contents
1-axis	Uxx.00.0	1-axis ready
2-axis	Uxx.00.1	2-axis ready
3-axis	Uxx.00.2	3-axis ready
4-axis	Uxx.00.3	4-axis ready
5-axis	Uxx.00.4	5-axis ready
6-axis	Uxx.00.5	6-axis ready
7-axis	Uxx.00.6	7-axis ready
8-axis	Uxx.00.7	8-axis ready

- (c) If you use “Link up/down” information as input condition of servo connection command, you can execute the command only when network cable is actually connected.
- (d) Don't give the command to each axis and give the command to the one axis among 1-axis~8-axis

6.3.49 Disconnect Servo (Command: XDCON)

(1) Program

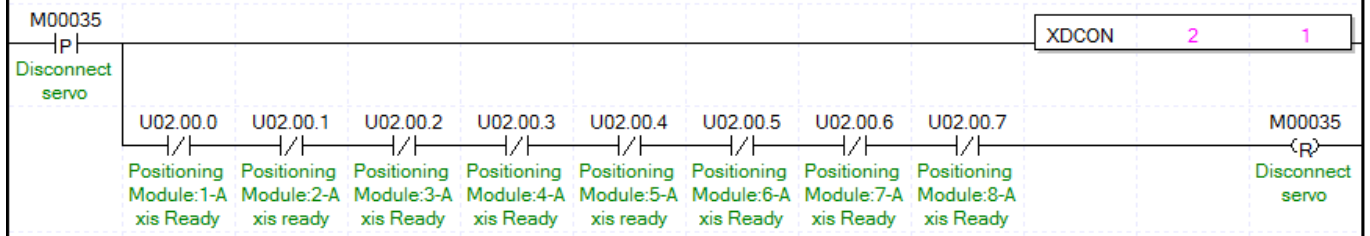

(2) Description

Device	Description
M0035	Servo disconnection input

Command	XDCON			Servo Disconnection	
Operand	OP1	Slot	Constant	WORD	Slot No. installed with positioning module
	OP2	Axis	PMLK,constant,D,Z,R,ZR	WORD	Command axis XBF-PN04B: 1axis~4axis XBF-PN08B:1axis~8axis

※ PMLK means P, M, L and K areas.

- (a) This is the command that disconnects the communication between the positioning module and the servo driver connected to that module through Ethernet cable.
- (b) If servo drive is disconnected normally, a bit corresponding to the connected axis of U device will be cleared.

Axis	Signal direction: PLC CPU ← Positioning module	
	Input signal	Contents
1-axis	Uxx.00.0	1-axis ready
2-axis	Uxx.00.1	2-axis ready
3-axis	Uxx.00.2	3-axis ready
4-axis	Uxx.00.3	4-axis ready
5-axis	Uxx.00.4	5-axis ready
6-axis	Uxx.00.5	6-axis ready
7-axis	Uxx.00.6	7-axis ready
8-axis	Uxx.00.7	8-axis ready

- (c) Don't give the command to each axis and give the command to the one axis among 1-axis~8-axis

6.3.50 Servo On (Command: XSVON)

(1) Program

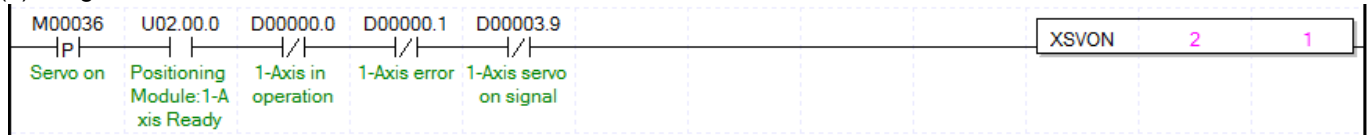

(2) Description

Device	Description
M00036	Servo On input
U02.00.0	Axis1 ready
D00000.0	Axis1 in operation
D00000.1	Axis1 error
D00003.9	Axis1 servo on signal

Command	XSVON				Servo Disconnection
	OP1	Slot	Constant	WORD	Slot No. installed with positioning module
Operand	OP2	Axis	PMLK,constant,D,Z,R,ZR	WORD	Command axis XBF-PN04B: 1axis~4axis XBF-PN08B:1axis~8axis

※ PMLK means P, M, L and K areas.

- This is the command that turns on the designated servo driver among servo drivers connected to the positioning module
- In order to start the motor, "Servo On" signal should be on.
- In the above example, it gives "Servo On" command to 1-axis.

6.3.51 Servo Off (Command: XSVOFF)

(1) Program

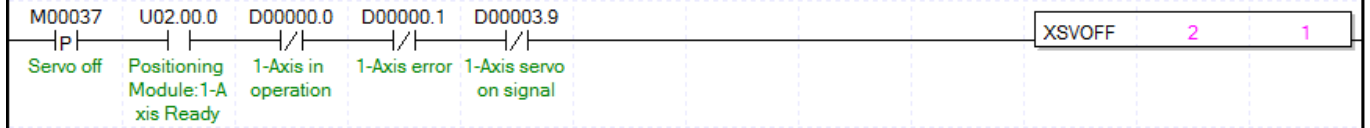

(2) Description

Device	Description
M00037	Servo Off input
U02.00.0	Axis1 ready
D00000.0	Axis1 in operation
D00000.1	Axis1 error
D00003.9	Axis1 servo on signal

Command	XSVOFF			Servo Disconnection	
Operand	OP1	Slot	Constant	WORD	Slot No. installed with positioning module
	OP2	Axis	PMLK,constant,D,Z,R,ZR	WORD	Command axis XBF-PN04B: 1axis~4axis XBF-PN08B:1axis~8axis

※ PMLK means P, M, L and K areas.

- (a) This is the command that turns off the designated servo driver among servo drivers connected to the positioning module
- (b) In order to start the motor, “Servo On” signal should be on.
- (c) In the above example, it gives “Servo Off” command to 1-axis.

6.3.52 Reset Servo Error (Command: XSCLR)

(1) Program

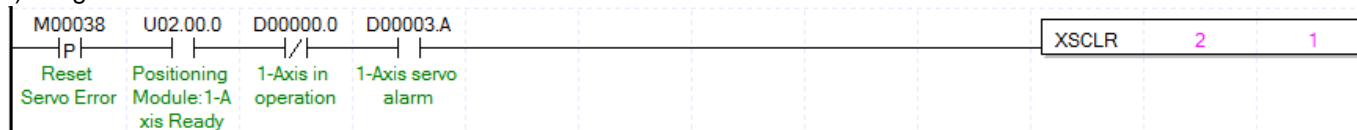

(2) Description

Device	Description
M00038	Servo Error Reset input
U02.00.0	Axis1 ready
D00000.0	Axis1 in operation
D00003.A	Axis1 servo alarm signal

Command	XSVOFF			Servo Disconnection	
	OP1	Slot	Constant	WORD	Slot No. installed with positioning module
Operand	OP2	Axis	PMLK,constant,D,Z,R,ZR	WORD	Command axis XBF-PN04B: 1axis~4axis XBF-PN08B:1axis~8axis

※ PMLK means P, M, L and K areas.

- (a) This is the command that clears servo driver alarm occurred at the specific axis among servo drivers connected to the positioning module.
- (b) If you reset the servo driver alarm without removing reason, it may not be cleared. So before resetting the servo driver alarm, remove the reason why alarm occurs.
- (c) In the above example, it resets servo alarm occurred at the axis1.
- (d) There may be servo error which can't be reset according to error type among EtherCAT servo drivers. So refer to servo driver manual.

6.3.53 Reset History Of Servo Error (Command: XSECLR)

(1) Program

M00039	U02.00.0	D00000.0								XSECLR	2	1
P		/										
Reset history of servo error	Positioning Module:1-Axis Ready	1-Axis in operation										

(2) Description

Device	Description
M00039	Servo Error History Reset input
U02.00.0	Axis1 ready
D00000.0	Axis1 in operation

Command	XSVOFF				Servo Disconnection
	OP1	Slot	Constant	WORD	Slot No. installed with positioning module
Operand	OP2	Axis	PMLK,constant,D,Z,R,ZR	WORD	Command axis XBF-PN04B: 1axis~4axis XBF-PN08B:1axis~8axis

※ PMLK means P, M, L and K areas.

- (a) This is the command that clears servo driver alarm history occurred at the specific axis among servo drivers connected to the positioning module.
- (b) Servo driver is saving up to 10 servo alarm history.
- (c) You can see alarm history of the servo driver at the XG-PM. For further information, refer to XG-PM manual.

6.3.54 Restart (Command: XRSTR)

(1) Program



(2) Description

Device	Description
M0003A	1axis restart command input

Command	XRSTR			Restart	
Operand	OP1	Slot	Constant	WORD	Slot No. installed with positioning module
	OP2	Axis	PMLK,constant,D,Z,R,ZR	WORD	Command axis XBF-PN04B: 1axis~4axis XBF-PN08B:1axis~8axis

※ PMLK means P, M, L and K areas.

- (a) This is the command that makes the servo restart with position data set up at previous operation after it stops with DEC. stop
- (b) You can't execute this command while axis is in operation.
- (c) If you start the axis with commands other than "Restart" after it stops with DEC. stop, "Restart" will not be executed
- (d) In example above, it gives the command to 1-axis
- (d) For detailed information on "Restart", refer to "9.2.20. Restart".

6.3.55 Read Servo Parameter (Command: XSVPRD)

(1) Program



(2) Description

Device	Description
M00047	1axis servo parameter read command input
D00002.7	1axis servo parameter R/W processing
D05000	1axis servo parameter read data

Command	XSVPRD				Servo Parameter Read
	OP1	Slot	Constant	WORD	Slot No. installed with positioning module
Operand	OP2	Axis	PMLK,constant,D,Z,R,ZR	WORD	Command axis XBF-PN04B: 1axis~4axis XBF-PN08B: 1axis~8axis
	OP3	Index	PMLK,constant,D,Z,R,ZR	WORD	Servo parameter Index (0x1000 ~ 0x9FFF)
	OP4	Sub-Index	PMLK,constant,D,Z,R,ZR	WORD	Servo parameter Subindex (0x00 ~ 0xFF)
	OP5	Data size	PMLK,constant,D,Z,R,ZR	WORD	Servo parameter Length (Byte unit) (1~4)

※ PMLK means P, M, L and K areas.

- (a) This is the command that reads parameters (CoE object) of the servo driver connected to positioning module.
- (b) It reads the object specified by OP3, OP4 and OP5 among servo parameter data(CoE Object).
- (c) You can execute this command while axis is in operation.
- (d) OP3 can be set as follows.

Setting value	Contents
0x1000 ~ 0x1FFF	Communication Profile Area
0x2000 ~ 0x5FFF	Manufacturer Specific Profile Area
0x6000 ~ 0x9FFF	Standardized Device Profile Area

- (e) OP4 can be set as follows.

Setting value	Contents
0x0 ~ 0xFF	Servo parameter Object Sub-index

- (f) OP5 can be set as follows.

Setting value	Contents
1 ~ 4	Servo parameter Object Byte Length

- (g) If you execute "Servo parameter read", the data read from positioning module will be saved in common area. In order to save in device for using in program, use GETM or GETMP command as program example after executing "Servo parameter read" command. Data common area address can be used to GETM or GETMP command as follows.

Address	Description
0	1axis servo parameter Index (high) / SubIndex (low)
1	1axis servo parameter data value
2	2axis servo parameter Index (high) / SubIndex (low)
3	2axis servo parameter data value
4	3axis servo parameter Index (high) / SubIndex (low)
5	3axis servo parameter data value
6	4axis servo parameter Index (high) / SubIndex (low)
7	4axis servo parameter data value
8	5axis servo parameter Index (high) / SubIndex (low)
9	5axis servo parameter data value
10	6axis servo parameter Index (high) / SubIndex (low)
11	6axis servo parameter data value
12	7axis servo parameter Index (high) / SubIndex (low)
13	7axis servo parameter data value
14	8axis servo parameter Index (high) / SubIndex (low)
15	8axis servo parameter data value

- (h) In the above program, saves in D05000 device to read data of h260B (DC link voltage) parameter. In the above program, saves the read data in d05000 5ms after executing "Read servo parameter" command when "1-Axis Servo Parameter R/W Processing" is off state. You have to execute GETM command minimum 4ms after executing "Read servo parameter" to save the read data in common area.
- (i) In the above example, if you want to find Index and SubIndex of read parameter, GETMP address set 0 and number of data set 2.
- (j) This action may be completed within several scans.

6.3.56 Write Servo Parameter (Command: XSVPWR)

(1) Program

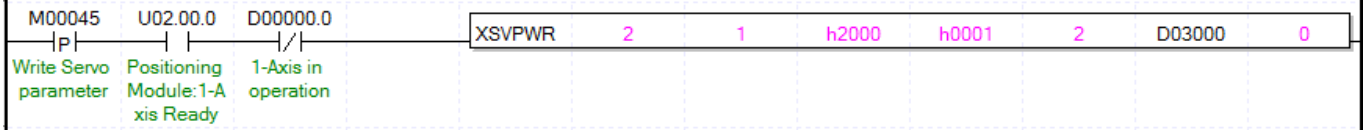

(2) Description

Device	Description
M00045	1axis servo parameter write input
D00000.0	1axis in operation
D03000	Device saving servo parameter data

Command	XSVPWR				Servo Parameter Write
Operand	OP1	Slot	Constant	WORD	Slot No. installed with positioning module
	OP2	Axis	PMLK,constant,D,Z,R,ZR	WORD	Command axis XBF-PN04B: 1axis~4axis XBF-PN08B:1axis~8axis
	OP3	Index	PMLK,constant,D,Z,R,ZR	WORD	Servo parameter Index (0x2000 ~ 0x9FFF)
	OP4	Sub-index	PMLK,constant,D,Z,R,ZR	WORD	Servo paramter subindex (0x00 ~ 0xFF)
	OP5	Data size	PMLK,constant,D,Z,R,ZR	WORD	Servo parameter Length (byte unit) (1~4)
	OP6	Data	PMLK,constant,D,Z,R,ZR	DINT	Write data (target value of objects to be changed among servo parameters)
	OP7	Write method	PMLK,constant,D,Z,R,ZR	WORD	Write method (0: RAM teaching, 1: ROM teaching)

※ PMLK means P, M, L and K areas.

- (a) This is the command that changes parameters (CoE object) of the servo driver connected to positioning module
- (b) It changes the object specified by OP3, OP4 and OP5 among servo parameter to OP6.
- (c) You can't execute this command while axis is in operation
- (d) OP3 can be set as follows.

Setting value	Contents
0x2000 ~ 0x5FFF	Manufacturer Specific Profile Area
0x6000 ~ 0x9FFF	Standardized Device Profile Area

(e) OP4 can be set as follows.

Setting value	Contents
0x0 ~ 0xFF	Servo parameter Object Sub-index

(f) OP5 can be set as follows.

Setting value	Contents
1 ~ 4	Servo parameter Object Byte Length

(g) OP7 can be set as follows.

Setting value	Teaching method
0	RAM teaching
1	ROM teaching

(h) This action may be completed within several scans.

6.3.57 Save Servo Parameter To EEPROM (Command: XSVMOVE)

(1) Program

M00046	U02.00.0	D00003.9	XSVMOVE			2	1	1
P	/	/						
Save servo parameter to EEPROM	Positioning Module:1-A xis Ready	1-Axis servo on signal						

(2) Description

Device	Description
M00046	1axis servo parameter save input
U02.00.0	1axis ready
D00003.9	1axis servo on signal

Command	XSVMOVE				Servo Parameter EEPROM Save	
	OP1	Slot	Constant	WORD	Slot No. installed with positioning module	
Operand	OP2	Axis	PMLK,constant,D,Z,R,ZR	WORD	Command axis XBF-PN04B: 1axis~4axis XBF-PN08B:1axis~8axis	
	OP3	Save axis	PMLK,constant,D,Z,R,ZR	WORD	Axis to save servo parameters	

※ PMLK means P, M, L and K areas.

- (a) This is the command that saves parameter of the servo driver connected to the positioning module at the EEPROM in the servo driver.
- (b) OP2, command axis, is different with the axis to save the servo driver. So in order to save the servo parameter, you have to set bit of corresponding axis at OP3.
- (c) It saves servo parameter of the axis set in OP3.
- (d) You can't execute this command while axis is in operation
- (e) Each bit of OP3 means each axis as follows. To select the axis, set the corresponding bit.

15 ~ 8 Bit	7Bit	6Bit	5Bit	4Bit	3Bit	2Bit	1Bit	0Bit
Not used	8axis	7axis	6axis	5axis	4axis	3axis	2axis	1axis

- (f) This action may be completed within several scans.

6.3.58 Control Torque (Command: XTRQ)

(1) Program

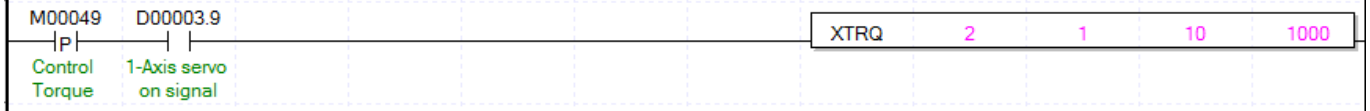

(2) Description

Device	Description
M00049	1axis torque control command input
D00003.9	1axis servo on signal

Command	XTRQ				Torque Control Command
Operand	OP1	Slot	Constant	WORD	Slot No. installed with positioning module
	OP2	Axis	PMLK,constant,D,Z,R,ZR	WORD	Command axis XBF-PN04B: 1axis~4axis XBF-PN08B:1axis~8axis
	OP3	Save axis	PMLK,constant,D,Z,R,ZR	INT	Torque value (unit: %, -32768 ~ 32767)
	OP4	Gradient	PMLK,constant,D,Z,R,ZR	WORD	Torque gradient (unit: ms, 0 ~ 65535 ms)

※ PMLK means P, M, L and K areas.

- (a) This is the command that executes torque control to positioning module. Torque control executes if torque value and torque gradient are set and a command is issued.
- (b) Set torque value (%) to OP3. Torque values work in % rated torque. (1 = 1% of rated torque)
For example, set 200 if the user wants to control torque in 200% of torque.
※ The allowable range of torque value may vary according to the connected servo drive. In general, target torque value is limited to the maximum torque setting.
- (c) Set time to take in reaching the target torque to OP4. If a command is executed, torque increases in this gradient until it reaches the set torque value.
- (d) Any command cannot be executed, the relevant axis is being operated for functions other than torque control.
- (e) This action may be completed within several scans.

6.3.59 Read Latch position data (Command: XLRD)

(1) Program

M0004A	D00002.8	XLRD	2	1	D03002
Read Latch position data	1-Axis Latch Complete				1-Axis Latch Position Data Number

(2) Description

Device	Description
M0004A	1axis latch data read command input
D00002.8	1axis latch complete
D03002	1axis latch position data number

Command	XLRD				Latch position data read Command
Operand	OP1	Slot	Constant	WORD	Slot No. installed with positioning module
	OP2	Axis	PMLK,constant,D,Z,R,ZR	WORD	Command axis XBF-PN04B: 1axis~4axis XBF-PN08B:1axis~8axis
	OP3	Device	PMLK,constant,D,Z,R,ZR	WORD	Leading No. of device to save the latch data

※ PMLK means P, M, L and K areas.

- (a) This command is used to read data count and latch position data saved and latched by the positioning module's external latch command.
- (b) Read latch data of an axis designated to OP2 of the positioning module designated to OP1 (the positioning module's slot number) and save the device designated to OP3.
- (c) The following values are saved on the device area designated to OP3.

Device No.	Size	Description
Device	WORD	Number of latch position data
Device +1	WORD	-
Device +2	DINT	Latch position data 1
Device +4	DINT	Latch position data 2
Device +6	DINT	Latch position data 3
Device +8	DINT	Latch position data 4
Device +10	DINT	Latch position data 5
Device +12	DINT	Latch position data 6
Device +14	DINT	Latch position data 7
Device +16	DINT	Latch position data 8
Device +18	DINT	Latch position data 9
Device +20	DINT	Latch position data 10

- (d) The Read Latch Position Data command is executed at every scan if the contact of input conditions as level command is On.
- (e) This action may be completed within several scans.

6.3.60 Reset Latch (Command: XLCLR)

(1) Program

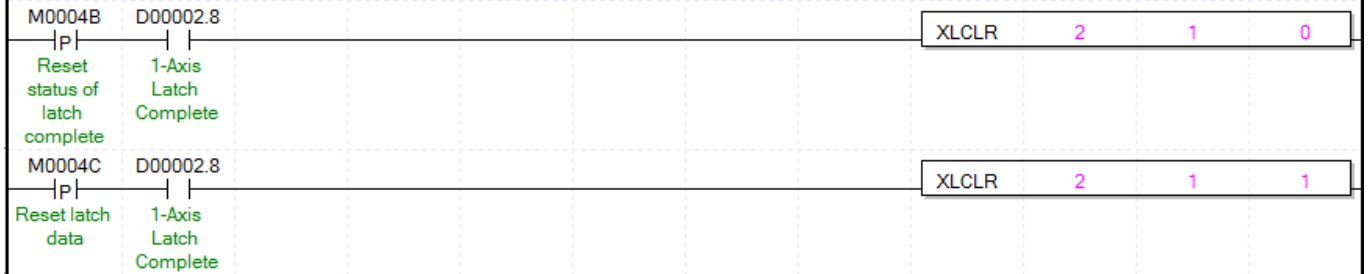

(2) Description

Device	Description
M0004B	1axis latch complete status reset command input
M0004C	1axis latch data reset command input
D00002.8	1axis latch complete

Command	XLCLR				Latch reset Command
Operand	OP1	Slot	Constant	WORD	Slot No. installed with positioning module
	OP2	Axis	PMLK,constant,D,Z,R,ZR	WORD	Command axis XBF-PN04B: 1axis~4axis XBF-PN08B:1axis~8axis
	OP3	Device	PMLK,constant,D,Z,R,ZR	WORD	Latch reset item

※ PMLK means P, M, L and K areas.

- (a) This command is used to initialize the data count and latch position data saved and latched on the positioning module or the state when latch is completed.
- (b) Reset latch data of an axis designated to OP2 of the positioning module designated to OP1 (the positioning module's slot number).
- (c) The following items are reset according to the Reset Latch items designated to OP3.
 - 0: Reset the state when latch is completed
 - 1: Reset latch position data and the state when latch is completed
(Values high than "1" are processed equally with "1")
- (d) If latch position data are read through the Read Latch Position Data command (XLRD) after 1 is set to

Remark

- OP3 and the Reset Latch command is executed, all of data become 0.
- (e) This action may be completed within several scans.

Two latch modes are supported. In case that a single trigger from two latch modes is set, ensure latch function to perform through the second touch probe 1 signal after the first touch probe 1 signal is inputted and latched. That is, in latch single trigger mode, the Reset Latch command will execute a function to activate the next latch trigger after the touch probe 1 signal is inputted and the latch location is saved.
(Even if the Set Latch command is re-executed after it is set as latch permission, it will work in the same way)

6.3.61 Set Latch (Command: XLSET)

(1) Program

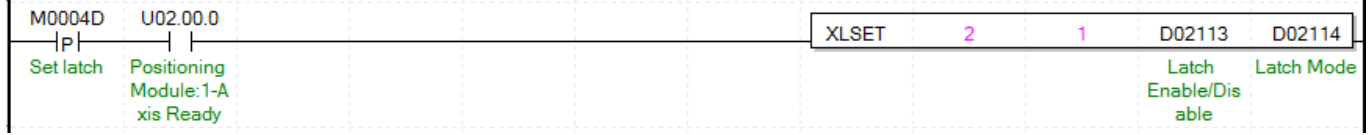

(2) Description

Device	Description
M0004D	1axis latch set command input
U02.00.0	1axis ready
D02113	Latch enable/disable
D02114	Latch mode

Command	XLSET				Latch set Command
Operand	OP1	Slot	Constant	WORD	Slot No. installed with positioning module
	OP2	Axis	PMLK,constant,D,Z,R,ZR	WORD	Command axis XBF-PN04B: 1axis~4axis XBF-PN08B:1axis~8axis
	OP3	Enable/Disable	PMLK,constant,D,Z,R,ZR	WORD	Latch enable/disable(0:disable, 1:enable)
	OP4	Mode	PMLK,constant,D,Z,R,ZR	WORD	Latch mode(0: single trigger, 1: Continuous trigger)

※ PMLK means P, M, L and K areas.

- (a) This command is used to enable/disable the positioning module's external latch function or to set latch mode.
- (b) Enable/Disable the latch function of an axis designated to OP2 of the positioning module designated to OP1 (the positioning module's slot number) or set latch mode.
- (c) Actions according to the Enable/Disable Latch item designated to OP3 are as following.
 0: latch prohibition 1: latch permission
 (Values high than "1" are processed equally with "1")
- (d) Actions according to the latch mode item designated to OP4 are as following.
 0: Single trigger (The current position latch is available only the touch probe 1 signal inputted at first after latch is enabled)
 1: Continuous trigger (The current position latch is available at every touch probe 1 signal after latch is enabled)
 (Values high than "1" are processed equally with "1")
- (e) This action may be completed within several scans.

6.3.62 Torque synchronous (Command: XSTC)

(1) Program

M00050	U02.00.1	XSTC	2	1	D02200	D02201	D02202	D02203	D02204
Torque synchronous	Positioning Module:2-Axis ready				Main axis torque ratio	Sub axis torque ratio	Main axis torque ratio	Sub axis torque ratio	Set Main axis

(2) Description

Device	Description
M00050	2axis torque synchronous command input
U02.00.1	2axis ready
D02200	Main axis torque ratio
D02201	Sub axis torque ratio
D02202	Main axis speed ratio(Unused)
D02203	Sub axis speed ratio(Unused)
D02204	Set main axis

Command	XLSET				Latch set Command
	OP1	Slot	Constant	WORD	Slot No. installed with positioning module
Operand	OP2	Axis	PMLK,constant,D,Z,R,ZR	WORD	Command axis XBF-PN04B: 1axis~4axis XBF-PN08B:1axis~8axis
	OP3	Main axis torque ratio	PMLK,constant,D,Z,R,ZR	WORD	Main axis torque ratio
	OP4	Sub axis torque ratio	PMLK,constant,D,Z,R,ZR	WORD	Sub axis torque ratio
	OP5	Main axis speed ratio	PMLK,constant,D,Z,R,ZR	WORD	Main axis speed ratio(Unused)
	OP6	Sub axis speed ratio	PMLK,constant,D,Z,R,ZR	WORD	Sub axis speed ratio(Unused)
	OP7	Set main axis	PMLK,constant,D,Z,R,ZR	WORD	Set main axis(1~8 : 1axis ~ 8axis)

※ PMLK means P, M, L and K areas.

- This command is used to execute the torque synchronous of positioning module at relevant axis.
- Execute torque synchronous of an axis designated to OP2 of the positioning module designated to OP1 (the positioning module's slot number)
- The axis to perform command execute torque synchronous by axis(OP7) as main axis.
- The axis to perform command execute torque synchronous by torque ratio(OP3, OP4) and speed ratio(OP5, OP6).
 Sub axis torque = (OP4/OP3) * Main axis torque
 Torque synchronous speed of sub axis = (OP6/OP5) * Speed of main axis
- This action may be completed within several scans.

6.3.63 Phasing Correction (Command: XPHASING)

(1) Program

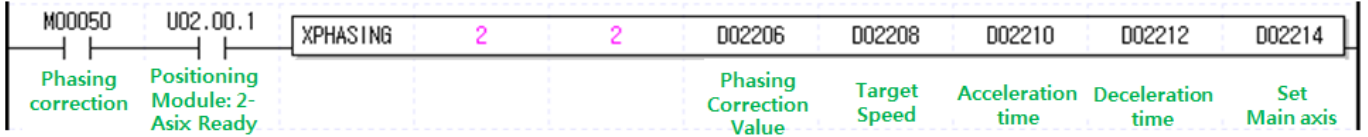

(2) Description

Device	Description
M00050	2axis Phasing correction command input
U02.00.1	2axis ready
D02206	Phasing Correction Value
D02208	Target speed
D02210	Acceleration time
D02212	Deceleration time
D02214	Set main axis

Command	XPHASING				Phasing correction
Operand	OP1	Slot	Constant	WORD	Slot No. installed with positioning module
	OP2	Axis	PMLK, constant, D, Z, R, ZR	WORD	Command axis
	OP3	Phasing Correction	PMLK, constant, D, Z, R, ZR	DINT	Phasing Correction Value (-2,147,483,648 ~ 2,147,483,647)
	OP4	Target speed	PMLK, constant, D, Z, R, ZR	DWORD	Phasing Correcting speed (The relative speed compared to the main axis speed)
	OP5	Acceleration time	PMLK, constant, D, Z, R, ZR	DWORD	Acceleration time (0 ~ 2,147,483,647 ms)
	OP6	Deceleration time	PMLK, constant, D, Z, R, ZR	DWORD	Deceleration time (0 ~ 2,147,483,647 ms)
	OP7	main axis	PMLK, constant, D, Z, R, ZR	WORD	Command axis

※ PMLK means P, M, L and K areas.

- (a) This command is used to execute the phasing correction functions of positioning module at relevant axis.
- (b) The axis OP2 of designated by OP1(the positioning module's slot number) is executed by as much as OP3(the phasing correction value) which use phasing correction speed(OP4), Acceleration time(OP5), Deceleration time(OP6).
- (c) The axis to perform command that execute phase correcting operation by axis(OP7) as main axis
- (d) The corresponding axis can be executed only when Speed Sync. or CAM operating.
- (e) This action may be completed within several scans.
- (f) For the detail description about speed sync., refer to "9.4.5 Phasing correction Control".
- (g) Version information which can execute 32bit speed sync. Command is as follows:

Product \ Item	Module O/S	XG5000	CPU O/S		
			XGK (XGK-CPUUx)	XGI (XGI-CPUUN)	XGR
XBF-PN04B	V1.1	V4.06	V4.53	V4.01	V2.6
XBF-PN08B	V1.5		(V1.03)	(V1.10)	

6.3.64 32bit Speed Sync (Command : XSSSD)

(1) Program

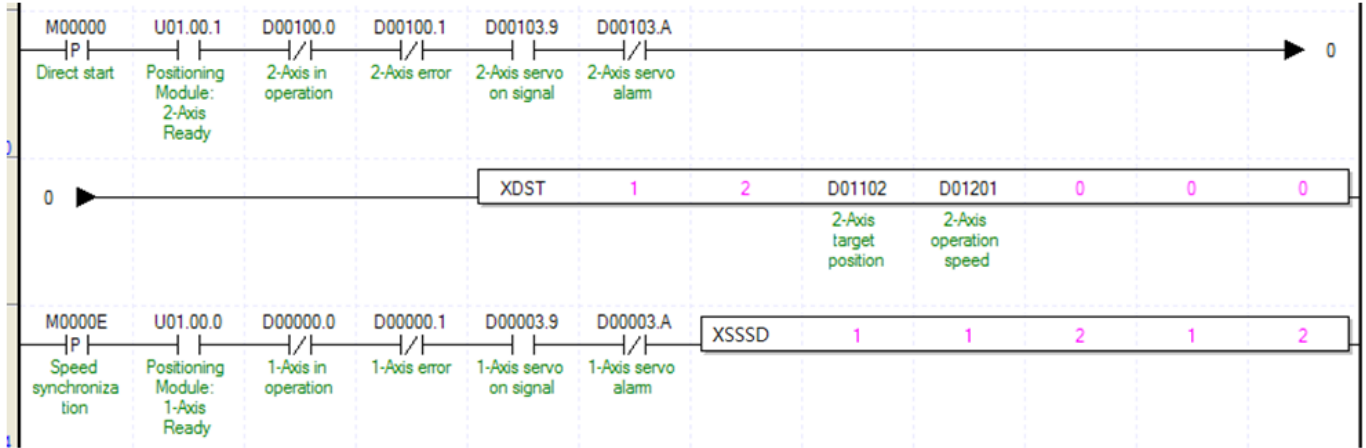

(2) Description

Device	Description
M0000E	axis1 speed sync start input
M0000D	Axis2 speed sync start input
D00003.9	axis1 servo on signal
D00103.9	Axis2 servo on signal

Command	XSSSD				32bitSynchronous start by speed
(Operand)	OP1	Slot	Constant	WORD	Slot No. installed with positioning module
	OP2	Axis	PMLK,constant,D,Z,R,ZR	WORD	Command axis
	OP3	Main axis ratio	PMLK,constant,D,Z,R,ZR	DINT	Speed sync. main axis ratio (-2147483648~2147483647)
	OP4	Subordinate axis ratio	PMLK,constant,D,Z,R,ZR	DINT	Speed sync. sub axis ratio (-2147483648~2147483647)
	OP5	Main axis	PMLK,constant,D,Z,R,ZR	WORD	Main axis(1 ~ 8 : axis1 ~ axis8, 9 : Encoder1, 10 : Encoder2)

※ PMLK means P, M, L and K areas.

- (a) This is the command that orders 32bit speed sync. to positioning module. Main and sub axis ratio can be set as range of 32bit integer values.
- (b) In the example program above, if the command of synchronous start by speed is executed, axis1 (subordinate axis) is indicated as 'in operation' but the motor does not operate. If operating axis2 set as the main axis, axis1 (subordinate axis) is operated depending on the designated ratio between main axis (OP3) and sub axis(OP4).
- (c) If speed sync. ratio (sub axis ratio / main axis ratio) is positive integer, sub axis operation turns main axis direction, if not positive integer, it turns the opposite of main axis direction.
- (d) For example, if main axis ratio is 100000, sub axis ratio is 123456, when main axis moves by 100000, sub axis moves 123456.
- (e) For the detail description about speed sync., refer to "9.4.1 Speed Synchronous Start Control".
- (f) D device signal (axis1 Servo ON, etc) which used in the example above is an assumption that saving the axis state value in D device area with XSRD command.
- (g) Version information which can execute 32bit speed sync. Command is as follows:

Item Product	Module O/S	XG5000	CPU O/S		
			XGK (XGK-CPUUx)	XGI (XGI-CPUUN)	XGR
XBF-PN04B	V1.1	V4.06	V4.53	V4.01	V2.6
XBF-PN08B	V1.5		(V1.03)	(V1.10)	

6.3.65 32bit Position-specified Speed synch (Command: XSSSPD)

(1) Program

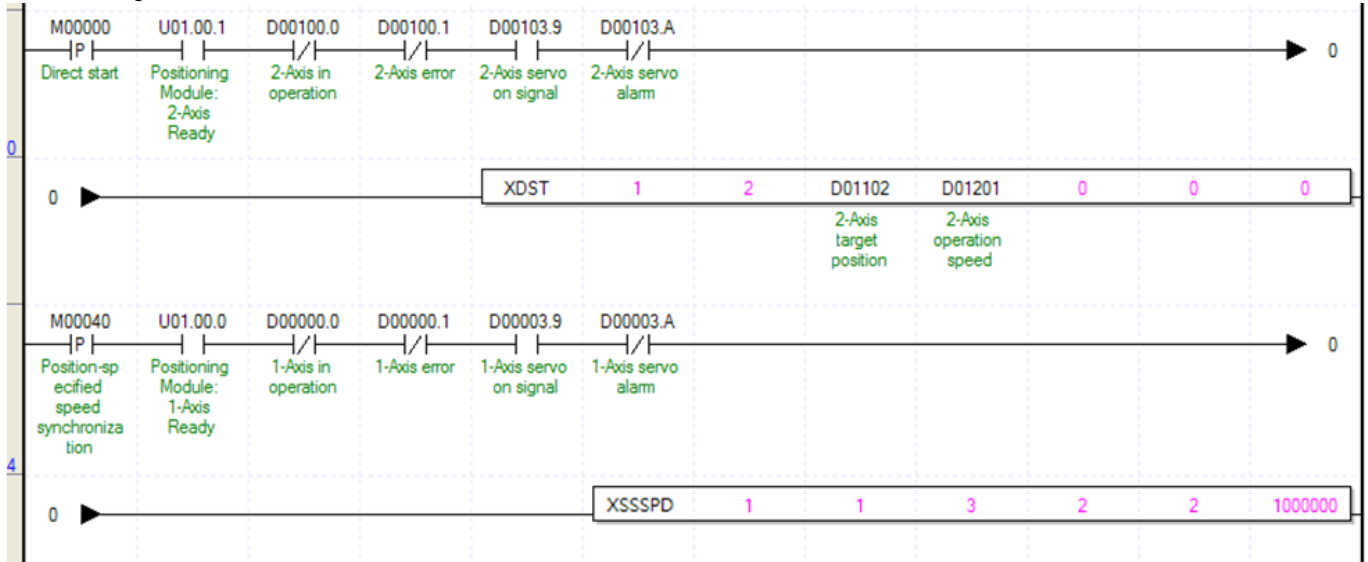

(2) Description

Device	Description
M00040	axis1 position-specified speed synch input
M0000D	axis2 direct start input
D00003.9	axis1 servo on signal
D00103.9	Axis2 servo on signal

Command	XSSSPD				32bitSpeed synchronous start by position
Operand	OP1	Slot	Constant	WORD	Slot No. installed with positioning module
	OP2	Axis	PMLK,constant,D,Z,R,ZR	WORD	Command axis
	OP3	Main axis ratio	PMLK,constant,D,Z,R,ZR	DINT	Speed sync. main axis ratio (-2147483648~2147483647)
	OP4	Subordinate axis ratio	PMLK,constant,D,Z,R,ZR	DINT	Speed sync. sub axis ratio (-2147483648~2147483647)
	OP5	Main axis	PMLK,상수,D,Z,R,ZR	WORD	Main axis (1 ~ 8: axis1 ~ axis8, 9: Encoder1, 10 Encoder2)
	OP6	Target position	PMLK,constant,D,Z,R,ZR	DINT	Target position of position-specified speed synch

※ PMLK means P area, M area, L area, K area.

- (a) This is the command that orders 32bit Position-specified Speed synch. to positioning module. Main and sub axis ratio can be set as range of 32bit integer values.
- (b) In the example program above, if the command of synchronous start by position-specified speed is executed, axis1 (subordinate axis) is indicated as 'in operation' but the motor does not operate. If operating axis2 set as the main axis, axis1 (subordinate axis) is operated depending on the designated ratio between main axis (OP3) and sub axis(OP4).After the operating position of axis1(subordinate axis) is equal to target position, then it terminate speed sync. and stops Immediately at that position.
- (c) If speed sync. ratio (sub axis ratio / main axis ratio) is positive integer, sub axis operation turns main axis direction, if not positive integer, it turns the opposite of main axis direction
- (d) For example, if main axis ratio is 100,000, sub axis ratio is 123,456 and target position is 1,000,000, when main axis moves by 100,000, sub axis moves 123,456. It stops by where position of main axis is at 1,000,000.
- (e) For the detail description about speed sync., refer to "9.4.1 Speed Synchronous Start Control".
- (f) D device signal (axis1 servo ON, etc) which used in the example above is an assumption that saving the axis state value in D device area with XSRD command.
- (g) Version information which can execute 32bit Position-specified Speed synch Command is as follows

Product \ Item	Module O/S	XG5000	CPU O/S		
			XGK (XGK-CPUUx)	XGI (XGI-CPUUN)	XGR
XBF-PN04B	V1.1	V4.06	V4.53	V4.01	V2.6
XBF-PN08B	V1.5		(V1.03)	(V1.10)	

6.3.66 Speed/Acceleration/Deceleration override (Command : XSETOVR)

(1) Program

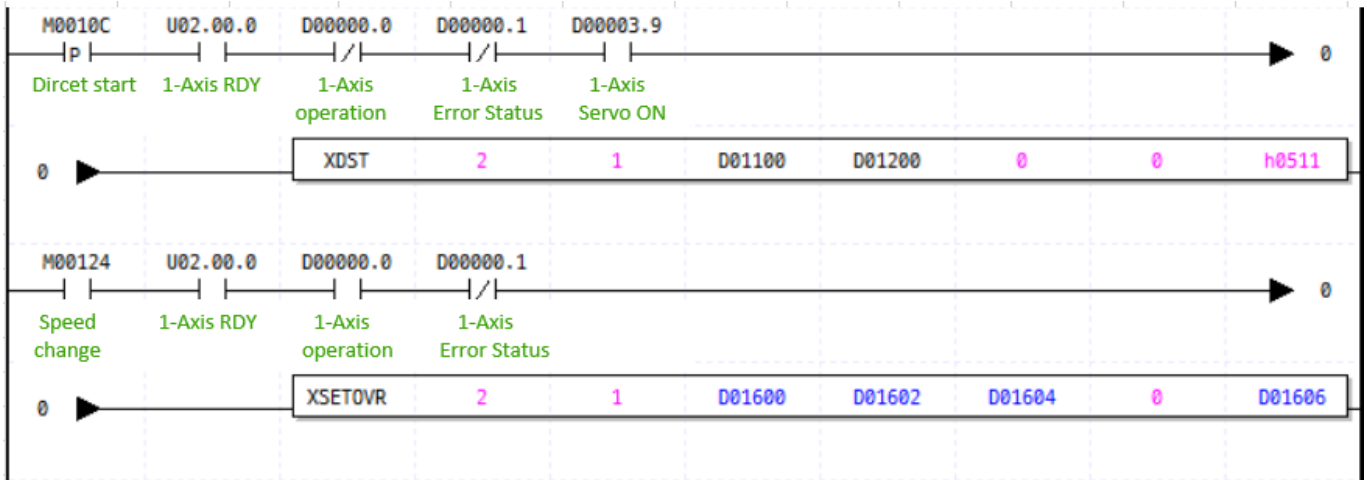

(2) Description

Device	Description
M00124	axis1 speed override input
M0010C	axis1 direct start input
U02.00.0	axis1 ready
D00000.0	axis1 signal in operation
D00000.1	axis1 error state
D00003.9	axis1 servo on
D01200	Command speed
D01600	Override ratio for speed (or Command speed)
D01602	Override ratio for acceleration time (or Command acceleration time)
D01604	Override ratio for deceleration time (or Command deceleration time)
D01606	Direction for operation

Command	XSETOVR				Speed Acceleration/Deceleration override
Operand	OP1	Slot	Constant	WORD	Slot No. installed with positioning module
	OP2	Axis	PMLK,Constant,D,Z,R,ZR	WORD	Command axis
	OP3	Speed	PMLK Constant,D,Z,R,ZR	DINT	Override ratio for speed (or Command speed)
	OP4	Acceleration	PMLK,Constant,D,Z,R,ZR	UDINT	Override ratio for acceleration time (or Command acceleration time)
	OP5	Deceleration	PMLK,Constant,D,Z,R,ZR	UDINT	Override ratio for deceleration time (or Command deceleration time)
	OP6	S-Curve	PMLK,Constant,D,Z,R,ZR	DINT	Unused S-Curve ratio (0= Trapezoid, 1~100=S- S-Curve ratio)
	OP7	Direction	PMLK,Constant,D,Z,R,ZR	DINT	Operation direction (1~3: 1- Forward, 2-Reverse, 3-Current Direction)

※ PMLK means P, M, L and K areas.

- (a) In case OP3, if '0:% set' is configured in common parameters, it means ratio for speed override and configurable setting area is -65,535 ~ +65,535. It means actually -655.35% ~ 655.35%.
If '1:% speed set' is configured, it means command speed and configurable setting area is -('speed limit' of 'operation parameter') ~ +('speed limit' of 'operation parameter').
- (b) In case OP4, if '0:% set' is configured in common parameters, it means ratio for acceleration time override ratio and configurable setting area is -65,535 ~ +65,535. It means actually -655.35% ~ 655.35%.
If '1:% speed set' is configured, it means acceleration time and configurable setting area is 0~ 4,294,967,295.
- (c) In case OP5, if '0:% set' is configured in common parameters, it means ratio for deceleration time override ratio and configurable setting area is -65,535 ~ +65,535. It means actually -655.35% ~ 655.35%.
If '1:% speed set' is configured, it means deceleration time and configurable setting area is 0~ 4,294,967,295.
- (d) Operation direction(OP6) is unused.
- (e) Operation direction(OP7) is configurable only for 1(Forward), 2(Reverse), 3(Current)

6.3.67 Absolute positioning CAM operation (Command : XCAMA)

(1) Program



(2) Description

Device	Description	Device	Description
M0000F	axis1 CAM operation input	D00003.9	Axis1 servo on
M0000D	axis2 direct start input	D00003.A	Axis1 servo error state
U02.00.0	Axis1 ready	D00100.0	Axis2 signal in operation
U02.00.1	Axis2 ready	D00100.1	Axis2 error state
D00000.0	Axis1 signal in operation	D00103.9	Axis2 servo on
D00000.1	Axis1 error state	D00103.A	Axis2 servo error state

Command	XCAM			CAM operating	
Operand	OP1	Slot	Constant	WORD	Slot No. installed with positioning module
	OP2	Axis	PMLK,Constant,D,Z,R,ZR	WORD	XBF-PN04B (1~4: axis-1 ~ axis-4) XBF-PN08B (1~8: axis-1 ~ axis-8)
	OP3	Main-axis	PMLK,Constant,D,Z,R,ZR	WORD	Main-axis XBF-PN04B (1~4: axis -1 ~ axis -4) XBF-PN08B (1~8: axis -1 ~ axis -8) 9: Encoder 1
	OP4	CAM block	PMLK,Constant,D,Z,R,ZR	WORD	CAM data block to be applied (1 ~ 9)
	OP5	CAM start Movement amount	PMLK,Constant,D,Z,R,ZR	DINT	CAM start movement amount
	OP6	Main axis offset	PMLK,Constant,D,Z,R,ZR	DINT	Main-axis offset
	OP7	Sub axis offset	PMLK,Constant,D,Z,R,ZR	DINT	Sub-axis offset

※ PMLK means P, M, L and K areas.

- (a) In the example program above, when absolute position cam operation command is executed, 1 axis of subordinate axis is displayed in operation but actual motor is not operated.

When starting the 2-axes set as the main axis, linear interpolation is performed that reaches the synchronous position while the main-axis reaches the synchronous start position (OP5). The synchronization position of the sub-axis moves according to the setting of the axis offset (OP6) and the vertical axis offset (OP7).

- (b) If the main-axis is operated by the CAM operation start movement amount (OP5), operation will start at the sub-axis position corresponding to the main-axis position according to the data value of the CAM data block set in the CAM block (OP4).

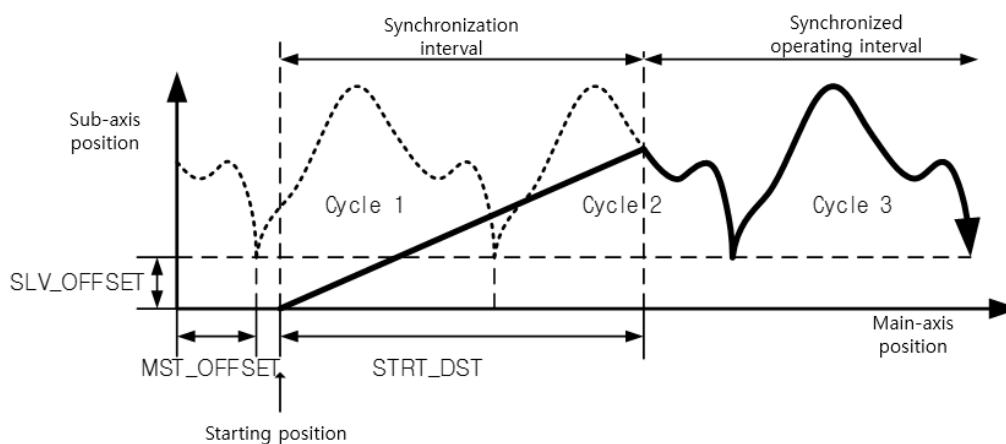

- (c) CAM data blocks can be set up to 9.
- (d) The CAM data can be set in the positioning package, and it must be downloaded to the positioning module before starting the cam operation.
- (e) For details on cam operation, refer to "9.4.3 CAM Operation".
- (g) To use the user CAM operation, set the cam block number to 9.
- (h) User CAM operation even during operation, user cam data can be changed by variable data write command.
- (i) Refer to "9.4.4 User CAM operation" for details on user CAM operation.

6.3.68 Touch Probe(Command: XTPROBE)

(1) Program

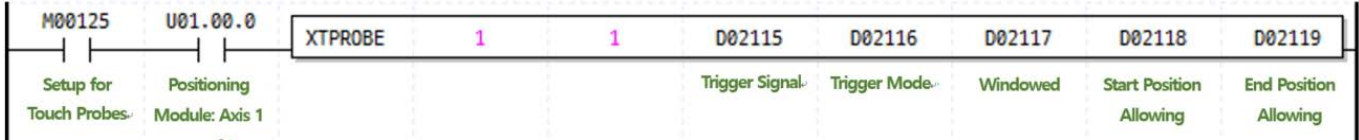

(2) Description

Device	Description
M00125	Setup for Axis 1 Touch Probe
U01.00.0	Axis 1 Ready
D02115	Trigger Signal
D02116	Trigger Mode
D02117	Windowed Mode
D02118	Start position allowing windowed mode
D02119	End position allowing windowed mode

Command	XTPROBE				Touch Probe
Operand	OP 1	Slot	Constant	WORD	Slot number where a positioning module is equipped
	OP 2	Axis	PMLK,Constant,D,Z,R,ZR	WORD	Axis to command
	OP 3	Trigger Signal	PMLK,Constant,D,Z,R,ZR	WORD	Signal to be used as a trigger input
	OP 4	Trigger Mode	PMLK,Constant,D,Z,R,ZR	WORD	Trigger Mode (0: Single trigger, 1: Double trigger)
	OP 5	Windowed Mode	PMLK,Constant,D,Z,R,ZR	WORD	Windowed Mode (0: Inactive, 1: Active)
	OP 6	Start position allowing windowed mode	PMLK,Constant,D,Z,R,ZR	DINT	Start position value allowing windowed mode (-2,147,483,648 ~ 2,147,483,647)
	OP 7	End position allowing windowed mode	PMLK,Constant,D,Z,R,ZR	DINT	End position value allowing windowed mode (-2,147,483,648 ~ 2,147,483,647)

※ PMLK means P, M, L and K areas.

- (a) This command is used to set up external touch probes for positioning modules.
- (b) Set up touch probe functions of the axis designated as OP 2 of positioning module designated as OP 1 (Slot number of positioning module).
- (c) OP 3 is Touch Probe signal to set trigger.
- 0: Rising Edge of the Touch Probe 1
 - 1: Rising Edge of the Touch Probe 2
 - 2: Falling Edge of the Touch Probe 1
 - 3: Falling Edge of the Touch Probe 2
 - 4: Index (Z) Pulse of the Touch Probe 1
 - 5: Index (Z) Pulse of the Touch Probe 2
- ※ Index (Z) Pulse, and rising and falling edges of each touch probe can not be run simultaneously.
- (d) OP 4 is trigger mode
- 0: Single trigger
(Latch the current position only in the first touch probe 1 signal to be input after setting up a trigger mode)
 - 1: Double trigger
(Latch the current position in every touch probe 1 signal to be input after setting up a trigger mode)
(A value that is greater than “1” is treated the same as “1”.)
- (e) OP 5 is window mode.
- 0: Inactive windowed mode
 - 1: Active windowed mode
- ※ When a windowed mode is activated, only a single trigger operates.
- (f) This operation can be completed by several scans.
- (g) Supported versions of the Command are as follows:

	Version
XBF-PN04B OS	V1.80 or higher
XBF-PN08B OS	V1.80 or higher
XGK CPU	V4.60 or higher
XGK CPU (High performance)	V1.3 or higher
XG5000	V4.29 or higher

6.3.69 Abort Trigger (Command: XABORTT)

(1) Program

M00126	XABORTT	1	1	D02115	D02120
P				Trigger Signal	Trigger Reset
Abort Trigger					

(2) Description

Device	Description
M00126	Abort the axis 1 trigger
D02115	Trigger Signal
D02120	Trigger Reset Items

Command	XABORTT				Trigger Abortion
Operand	OP 1	Slot	Constant	WORD	Slot number where a positioning module is equipped
	OP 2	Axis	PMLK,Constant,D,Z,R,ZR	WORD	Axis to command
	OP 3	Trigger Signal	PMLK,Constant,D,Z,R,ZR	WORD	Signal to reset triggers
	OP 4	Trigger Reset Items	PMLK,Constant,D,Z,R,ZR	WORD	Trigger Reset Items

※ PMLK means P, M, L and K areas.

- (a) This is a command used to abort external trigger functions of positioning modules.
- (b) Abort trigger functions of the axis designated as OP 2 of positioning module designated as OP 1 (Slot number of positioning module).
- (c) OP 3 is a Touch Probe signal to abort trigger.
 - 0: Rising Edge of the Touch Probe 1
 - 1: Rising Edge of the Touch Probe 2
 - 2: Falling Edge of the Touch Probe 1
 - 3: Falling Edge of the Touch Probe 2
 - 4: Index (Z) Pulse of the Touch Probe 1
 - 5: Index (Z) Pulse of the Touch Probe 2
- (d) OP 4 is reset item
 - 0: Reset the status that completes triggers
 - 1: Reset the status that completes triggers and the data of trigger positions
- (e) Supported versions of the Command are as follows:

	Version
XBF-PN04B OS	V1.80 or higher
XBF-PN08B OS	V1.80 or higher
XG5000	V4.29 or higher

6.3.70 Torque Control Mode Speed Limits (Command: XTRQSL)

(1) Program

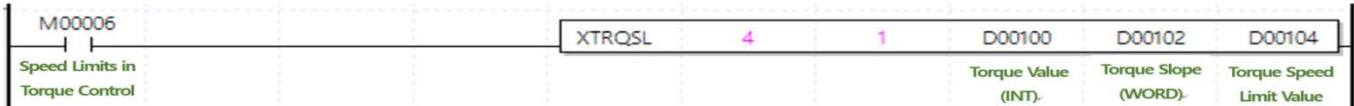

(2) Description

Device	Description
M00006	Run Speed Limits Command in Axis 1 Torque Control Mode
D00100	Torque Value
D00102	Torque Slope
D00104	Torque Speed Limit Value

Command	XTRQSL				Speed Limits in Torque Control Mode
Operand	OP 1	Slot	Constant	WORD	Slot number where a positioning module is equipped
	OP 2	Axis	PMLK,Constant,D,Z,R,ZR	WORD	Axis to command
	OP 3	Torque Value	PMLK,Constant,D,Z,R,ZR	INT	Torque Value (Unit: 0.1%, -32768~32767)
	OP 4	Slope	PMLK,Constant,D,Z,R,ZR	WORD	Torque Slope (Unit: ms, 0~65535ms)
	OP 5	Speed Limit Value	PMLK,Constant,D,Z,R,ZR	WORD	Speed Limit Value (Unit: rpm, 0~6000)

※ PMLK means P, M, L and K areas.

- (A) This command is one that is used to perform torque control under the speed limit of positioning module. The command applies only to the LS Electric Servo Drive family.
- (b) Give the speed limits in torque control mode command to the axis designated as OP 2 of positioning module designated as OP 1 (Slot number of positioning module).
- (C) Set the targeted torque value (%) at OP 3. The torque value operates by 0.1% of rated torque. (1 = 0.1% of rated torque)
For example, set 2000 if you perform torque control by 200.0% of rated torque.
- (D) Set the time to arrive at the targeted torque to OP 4. When the command is performed, the torque is increased to the torque value set to the targeted torque with this slope.
- (E) The speed limit value of OP 5 is set to the 'speed limit value upon torque control' parameter of Servo Drive. Therefore, it runs by the maximum speed value during torque rotation.
- (F) When the OP2 axis is operating except torque control, this can not be performed.
- (g) This operation can be completed by several scans
- (H) Supported versions of the Command are as follows:

	Version
XBF-PN04B OS	V1.80 or higher
XBF-PN08B OS	V1.80 or higher
XG5000	V4.29 or higher

6.3.71 Synchronous speed designating synchronous position (Command: XGEARIP)

(1) Program

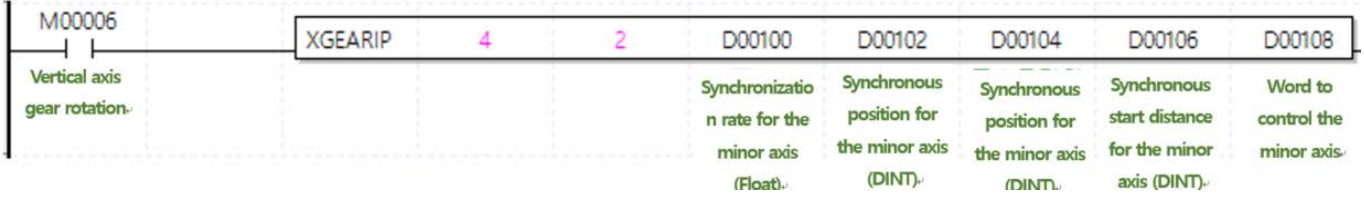

(2) Description

Device	Description
M00006	Run synchronous speed command in Axis 2 synchronous position designation
D00100	Synchronization rate
D00102	Synchronous position for the main axis
D00104	Synchronous position for the minor axis
D00106	Synchronous start distance for the main axis
D00108	Control word

Com mand	XGEARIP				Synchronous speed designating synchronous position
Operan d	OP 1	Slot	Constant	WORD	Slot number where a positioning module is equipped
	OP 2	Axis	PMLK,Constant, D,Z,R,ZR	WORD	Axis to command
	OP 3	Synchronization rate	PMLK,Constant, D,Z,R,ZR	REAL	Synchronization rate (the ratio of the minor axis/the ratio of the major axis)
	OP 4	Synchronous position for the main axis	PMLK,Constant, D,Z,R,ZR	DINT	Position of the main axis to be synchronized
	OP 5	Synchronous position for the minor axis	PMLK,Constant, D,Z,R,ZR	DINT	Synchronous position for the minor axis
	OP 6	Synchronous start position for the major axis	PMLK,Constant, D,Z,R,ZR	DINT	Distance of the major axis to start synchronous rotation
	OP 7	Control word	PMLK,Constant, D,Z,R,ZR	WORD	Main axis

※ PMLK means P, M, L and K areas.

- (a) This command is used to conduct the synchronous speed rotation that can designate the distance where the synchronous speed is conducted and to start the synchronous speed rotation at the designated position of positioning module.
- (b) Give the synchronous speed designating synchronous position command to the axis designated as OP 2 of positioning module designated as OP 1 (Slot number of positioning module).
- (c) Set the synchronization rate to OP 3. If the synchronization rate is positive, it rotates in the direction of the major axis. But if it is negative, it rotates in the opposite direction of the major axis.
- (d) For example, if the synchronization rate is set to 0.5, the major axis moves 3000 when the minor axis does 1500.
- (e) This operation can be completed only through several scans.
- (g) Supported versions of the Command are as follows:

	Version
XBF-PN04B OS	V1.80 or higher
XBF-PN08B OS	V1.80 or higher
XG5000	V4.29 or higher

Chapter 7 Function Block

7.1 Common Issues of Function Block

(1) The functions and directions of the following I/O parameter are common for positioning function block.

Category	Parameter	Data Type	Description
Input	REQ	BOOL	Execution request of function block - Function block is executed if "0→1"(edge or level) as long as the connection condition is met during the program.
	BASE	USINT	Base number (Range: 0 ~ 7)
	SLOT	USINT	Slot number (range: 0 ~ 7)
	AXIS	USINT	Axis number (XBF-PN04B: 1~4, XBF-PN08B: 1~8) "Error 6" is generated if a value out of the setting range is set
Output	DONE	BOOL	Indicates function block execution end state - "1" is outputted if function block is executed completely without error and maintained until the next execution; if an error occurs, it outputs "0"
	STAT	USINT	Error state indication - If an error occurs during function block execution, it generates the error number.

Error code of STAT of Positioning Function Block is as follows.

STAT	Description	Detailed description
0	Normal	In case function block is executed normally, DONE=1 and STAT=0.
1	Base number setting error	Base number is out of range Setting range according to CPU is as follows. Setting range: 0
3	Slot number setting error	Slot number is out of range (2 ~ 3).
4	Empty slot error	There is no module at the position specified with BASE, SLOT.
5	Positioning module mismatch	There is a module other than positioning module at the position specified with BASE, SLOT.
6	Axis number error	AXIS is out of range (1 ~ 8).
10	Function Block overlap execution error	This error occurs when previously executed function block is not yet read by positioning module before executing new function block. Execute new function block after previously executed function block is read by positioning module. It needs up to 2~4ms to read the function block after executing function block.
11	Input variable setting error	Variable other than BASE, SLOT, AXIS is out of range. Check the input variable
22	Base skip error	Check the base skip setting
24	Slot skip error	Check the base skip setting
101 : 821	Positioning module error	Error that occurred at positioning module as a result of executing the function block

- (2) The position and speed setting ranges of positioning function block are as follows and the ranges are based on pulse for position or pulse/sec for speed.

Category	Setting unit	Setting range
Position	pulse	-2,147,483,648 ~ 2,147,483,647[pulse]
	mm	-2,147,483,648 ~ 2,147,483,647[x 10 ⁻⁴ mm]
	inch	-2,147,483,648 ~ 2,147,483,647[x 10 ⁻⁵ inch]
	degree	-2,147,483,648 ~ 2,147,483,647[x 10 ⁻⁵ degree]
Speed	pulse/sec	1 ~ 2,147,483,647 [pulse/sec]
	mm/min	1 ~ 2,147,483,647 [X10 ⁻² mm/min]
	inch/min	1 ~ 2,147,483,647 [X10 ⁻³ Inch/min]
	degree/min	1 ~ 2,147,483,647 [X10 ⁻³ degree/min]

- (3) For the data types which usually used on function block are as follows.

No.	Initial	Data Types	Size(Bit)	Range
1	BOOL	Boolean	1	0, 1
2	SINT	Short Integer	8	-128 ~ 127
3	USINT	Unsigned Short Integer	8	0 ~ 255
4	INT	Integer	16	-32768 ~ 32767
5	UINT	Unsigned Integer	16	0 ~ 65535
6	DINT	Double Integer	32	-2147483648 ~ 2147483647
7	UDINT	Unsigned Double Integer	32	0 ~ 4294967295

7.2 Function Block of Positioning Module

Here describes the positioning function blocks used in XEC CPU Module.

No.	Name	Description	Operation condition	Notes
1	XPM_CRD	Operation information read	Edge	7.3.1
2	XPM_SRD	Operation state read	Edge	7.3.2
3	XPM_ENCRD	Encoder value read	Edge	7.3.3
4	XPM_SVERD	Servo Error Information Read	Edge	7.3.4
5	XPM_LRD	Latch position data read	Edge	7.3.5
6	XPM_SBP	Basic parameter teaching	Edge	7.4.1
7	XPM_SEP	Extended parameter teaching	Edge	7.4.2
8	XPM_SMP	Manual operation parameter teaching	Edge	7.4.3
9	XPM_SIP	Input signal parameter teaching	Edge	7.4.4
10	XPM_SIPT	Input signal parameter - Switching torque of external position/torque control teaching(XPM_SIPT)	Edge	7.4.5
11	XPM_SCP	Common parameter teaching	Edge	7.4.6
12	XPM_SMD	Operation data teaching	Edge	7.4.7
13	XPM_ATEA	Teaching array	Edge	7.4.8
14	XPM_VRD	Variable data read	Edge	7.4.9
15	XPM_VWR	Variable data write	Edge	7.4.10
16	XPM_WRT	Parameter/operation data save	Edge	7.4.11
17	XPM_ORG	Homing start	Edge	7.5.1
18	XPM_DST	Direct start	Edge	7.5.2
19	XPM_IST	Indirect start	Edge	7.5.3
20	XPM_ELIN	Circular Interpolation Operation	Edge	7.5.4
21	XPM_SST	Simultaneous start	Edge	7.5.5
22	XPM_PST	Point start	Edge	7.5.6
23	XPM_STP	Deceleration stop	Edge	7.5.7
24	XPM_EMG	Emergency stop	Edge	7.5.8
25	XPM_RSTR	Restart	Edge	7.5.9
26	XPM_TRQ	Control Torque	Edge	7.5.10
27	XPM_TRQSL	Control Speed Limit Torque	Edge	7.5.11
28	XPM_JOG	JOG operation	Edge	7.6.1
29	XPM_INC	Inching operation	Edge	7.6.2
30	XPM_RTP	return to the previous position of manual operation	Edge	7.6.3
31	XPM_SSP	Position synchronization	Edge	7.7.1
32	XPM_SSS	Speed synchronization	Edge	7.7.2
33	XPM_SSSP	Positioning Speed Synchronous	Edge	7.7.3
34	XPM_CAM	Cam Start	Edge	7.7.4
35	XPM_CAMO	Main axis offset-specified CAM start	Edge	7.7.5
36	XPM_STC	Torque synchronous	Edge	7.7.6
37	XPM_PHASING	Phase Correction	Edge	7.7.7
38	XPM_SSSD	32-bit speed synchronization	Edge	7.7.8
39	XPM_SSSPD	32-bit Position specified speed/position switching control	Edge	7.7.9
40	XPM_CAMA	Absolute positioning CAM Operation	Edge	7.7.10
41	XPM_GEARIP	Synchronous speed designating synchronous position	Level	7.7.11
42	XPM_POR	Position override	Level	7.8.1

No.	Name	Description	Operation condition	Notes
43	XPM_SOR	Speed override	Level	7.8.2
44	XPM_PSO	Positioning speed override	Level	7.8.3
45	XPM_PTV	Position/speed switching control	Level	7.8.4
46	XPM_VTP	Speed/position switching control	Edge	7.8.5
47	XPM_VTPP	Position specified speed/position switching control	Edge	7.8.6
48	XPM_PTT	Position/torque switching control	Edge	7.8.7
49	XPM_SKP	Skip operation	Edge	7.8.8
50	XPM_NMV	Continuous operation	Edge	7.8.9
51	XPM_SNS	Start step No. change	Edge	7.8.10
52	XPM_SRS	Repeat step No. change	Edge	7.8.11
53	XPM_PRS	Current position preset	Edge	7.8.12
54	XPM_EPRES	Encoder value preset	Edge	7.8.13
55	XPM_SETOVR	Speed Acceleration / Deceleration override	Edge	7.8.14
56	XPM_RST	Error reset/output disabled release	Level	7.9.1
57	XPM_HRST	Error History Reset	Edge	7.9.2
58	XPM_FLT	Floating origin setting	Edge	7.10.1
59	XPM_MOF	M code release	Edge	7.10.2
60	XPM_LCLR	Latch reset	Edge	7.10.3
61	XPM_LSET	Latch set	Level	7.10.4
62	XPM_TPROBE	Torque Control (XPM_TRQ)	Edge	7.10.5
63	XPM_ABORTT	Trigger Abortion	Edge	7.10.6
64	XPM_ECON	Servo communication connect	Edge	7.11.1
65	XPM_DCON	Servo communication disconnect	Edge	7.11.2
66	XPM_SVON	Servo On	Edge	7.11.3
67	XPM_SVOFF	Servo Off	Edge	7.11.4
68	XPM_SRST	Servo error reset	Edge	7.11.5
69	XPM_SHRST	Servo error history reset	Edge	7.11.6
70	XPM_SVIRD	Servo external input information read	Edge	7.11.7
71	XPM_SVPRD	Servo driver parameter read	Edge	7.11.8
72	XPM_SVPWR	Servo driver parameter write	Edge	7.11.9
73	XPM_SVSAVE	Servo driver parameter save	Edge	7.11.10

Remark

- Dedicated commands of positioning module are executed in rising edge. Therefore, it operates when the input condition is "On". If you want it to operate again, the input condition has to be "Off" first, then be "On". But, XPM_SRST will be operated by high level. Therefore, it continues to operate during the input condition is "On". If the input condition become "Off", it does not operate.
- Duration time of XPM command is as follows.
 - XPM_WRT : 15ms (per each axis)
 - The commands excepting XPM_WRT
2ms (when using 2 axes) ~ 6ms (when using 8 axes)
- Don't use XVRD and XVWR command at the same time. That is, you must execute a command after the other command's operation completes. Please note that the command don't execute at the same time in case the command axis is same or different.

Remark

▷ For the positioning block except XPM_SRD, XPM_CRD, XPM_ENCRD, XPM_SVERD, XPM_SVIRD and XPM_LRD, only one should be executed for one function block execution axis within a scan. If using it as presented in the following example program, the function block does not work properly.

If executing a different function block

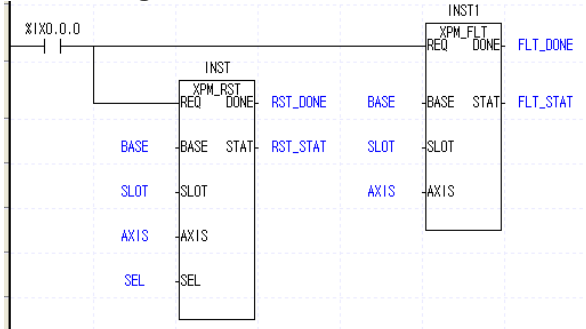

If executing a same function block

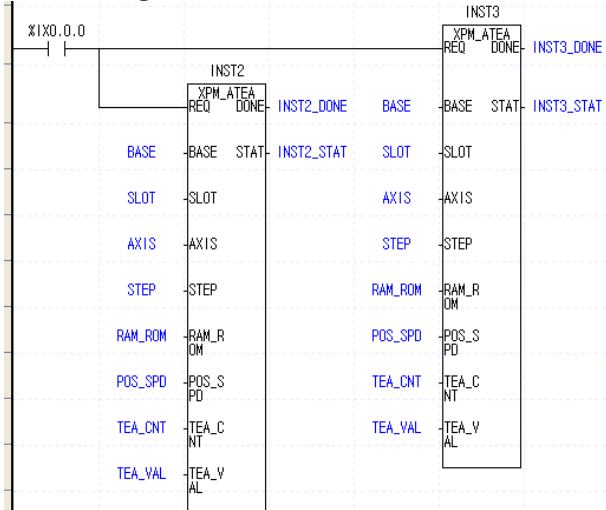

▷ Same block can be executed on a different axis.(except for XPM_VRD, XPM_VWR command)

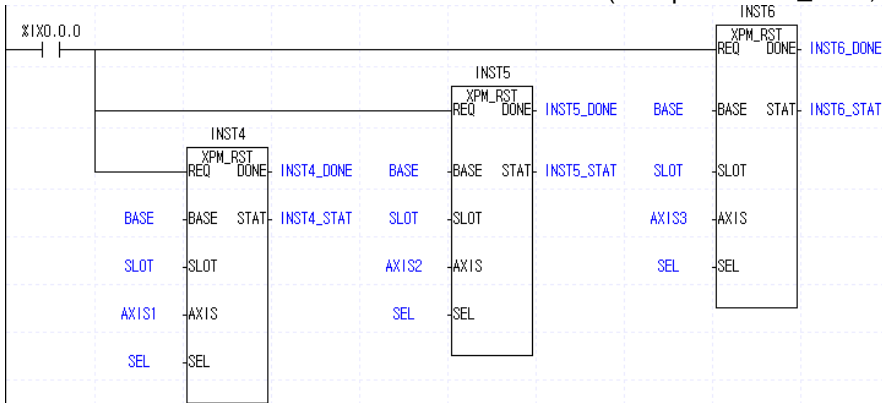

7.3 Function Block related to Module Information Read

7.3.1 Operation Information Read (XPM_CRD)

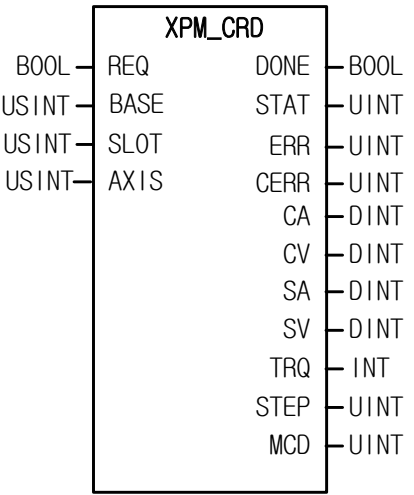
Form of Function Block	Description
	<p>Input</p> <p>REQ : Request for execution of function block BASE : Set the base no. with module SLOT : Set the slot no. with module AXIS : Axis to command XBF-PN04B:1~4, XBF-PN08B:1~8</p> <p>Output</p> <p>DONE : Maintain 1 after first operating STAT : Output the error no. in operation ERR : Display axis error CERR : Display common error CA : Display the command position CV : Display the command speed SA : Display the current position SV : Display the current speed TRQ: Display the current torque STEP : Display step no. of the current operation data MCD : Display the current M code value</p>

- (1) Read the axis state of current operation designated in the axis of designated positioning module with BASE (Base no. of Positioning module) and SLOT (Slot no. of Positioning module).
- (2) The operation information is saved in parameter set on output of function block.
- (3) You can set axis to command in "AXIS" and the following value is available. If you set other values, error code "6" appears.
XBF-PN04B:1~4, XBF-PN08B:1~8
- (4) You can monitor command position, command speed, current position, current speed, torque, operation data no. and M code value of axis already set through reading them or use them as a condition in user's program.

7.3.2 Operation State Read (XPM_SRD)

Form of Function Block	Description
<div style="text-align: center; border: 1px solid black; padding: 5px; width: fit-content; margin: 0 auto;"> <p>XPM_SRD</p> </div> <pre style="font-family: monospace; margin: 0;"> BOOL REQ DONE BOOL USINT BASE STAT UINT USINT SLOT ST1 BOOL[8] USINT AXIS ST2 BOOL[8] ST3 BOOL[8] ST4 BOOL[8] ST5 BOOL[8] ST6 BOOL[8] ST7 BOOL[8] </pre>	<p>Input</p> <p>REQ : Request for execution of function block BASE : Set the base no. with module SLOT : Set the slot no. with module AXIS : Axis to command XBF-PN04B:1~4, XBF-PN08B:1~8</p> <p>Output</p> <p>DONE : Maintain 1 after first operating STAT : Output the error no. in operation ST1 : State 1 ST2 : State 2 ST3 : State 3 ST4 : State 4 ST5 : State 5 ST6 : State 6 ST7 : State 7</p>

- (1) Give “Bit Information of Current operation reading” command to the axis designated as the axis of positioning module with BASE (Base no. of Positioning module) and SLOT (Slot no. of Positioning module).
- (2) The bit information about the state of current operation is saved in parameter set on ST1 ~ ST7.
- (3) You can set axis to command in “AXIS” and the following value is available. If you set other values, error code “6” appears.
 XBF-PN04B:1~4, XBF-PN08B:1~8

(4) The contents of output parameters, ST1 ~ ST7 are important information necessarily applied in the program.

	Bit	Description	Bit	Description
ST1	[0]	Operating(0:STOP, 1:BUSY)	[4]	Origin fix state(0:Uncompletion, 1:Completion)
	[1]	Error state	[5]	Common error state
	[2]	Positioning completion	[6]	Stop
	[3]	M code On signal(0:Off, 1:On)	[7]	In reading/writing variable data
ST2	[0]	Upper limit detection	[4]	In acceleration
	[1]	Lower limit detection	[5]	In constant speed
	[2]	Emergent Stop	[6]	In deceleration
	[3]	Direction(0:Forward, 1:Reverse)	[7]	In dwell
ST3	[0]	Axis1 in positioning control	[4]	In circular interpolation operation
	[1]	Axis1 in speed control	[5]	In homing operation
	[2]	In linear interpolation	[6]	In position synchronous start operation
	[3]	-	[7]	In speed synchronous start operation
ST4	[0]	In jog operation	[4]	In returning to position before manual operation
	[1]	-	[5]	In CAM control operation
	[2]	In inching operation	[6]	In Feed control operation
	[3]	-	[7]	In ellipse interpolation operation
ST5	[0]	Main axis information*1 XBF-PN04B:1~4, XBF-PN08B:1~8 9: Encoder1	[4]	Axis state(0:Main axis, 1: sub axis)
	[1]		[5]	-
	[2]		[6]	-
	[3]		[7]	Now processing Servo parameter R/W (0: not processing R/W, 1: processing R/W)
ST6	[0]	Emergent stop/Dec. stop signal	[4]	Upper limit signal
	[1]	-	[5]	Lower limit signal
	[2]	-	[6]	Home signal
	[3]	-	[7]	DOG signal
ST7	[0]	External command signal	[4]	In-position signal
	[1]	Servo on signal	[5]	Declination counter clear output signal
	[2]	Servo alarm signal	[6]	-
	[3]	In-position signal	[7]	Communication error state (0:normal, 1: error)

*1 : For example, ST5 =h09 means encoder1, ST5=h04 means 4 axis

7.3.3 Encoder Value Read (XPM_ENCRD)

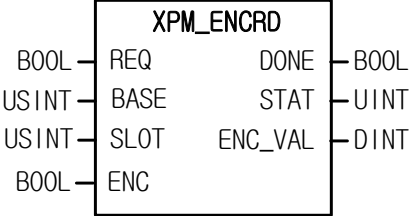
Form of Function Block	Description
	<p>Input</p> <p>REQ : Request for execution of function block BASE : Set the base no. with module SLOT : Set the slot no. with module ENC : Encoder no. 0: Encoder 1 1: Encoder 2</p> <p>Output</p> <p>DONE : Maintain 1 after first operating STAT : Output the error no. in operation ENC_VAL : Current value of encoder</p>

- (1) Give “Encoder Reading” command to the axis designated as the axis of positioning module with BASE (Base no. of Positioning module) and SLOT (Slot no. of Positioning module).
- (2) The current encoder value is displayed on ENC_VAL
- (3) Set the encoder you want to read in ENC.
 - 0: Encoder1
 - 1: Encoder 2

7.3.4 Servo Error Information Read (XPM_SVERD)

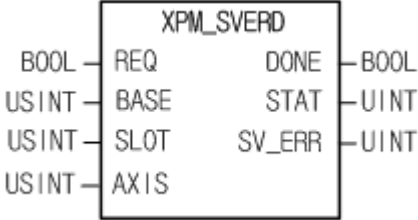
Form of Function Block	Description
	<p>Input</p> <p>REQ : Request for execution of function block BASE : Set the base no. with module SLOT : Set the slot no. with module AXIS : Axis to command XBF-PN04B:1~4, XBF-PN08B:1~8</p> <p>Output</p> <p>DONE : Maintain 1 after first operating STAT : Output the error no. in operation SV_ERR: Servo error information</p>

- (1) It reads servo error information corresponding to the designated axis of positioning module designated by BASE (Base number of positioning module) and SLOT (Slot number of positioning module)
- (2) The current servo error information is saved in the variable designated by SV_ERR.
- (3) You can set axis to command in "AXIS" and the following value is available. If you set other values, error code "6" appears.
 XBF-PN04B:1~4, XBF-PN08B:1~8

7.3.5 Latch Position Data Read (XPM_LRD)

Form of Function Block	Description
<div style="text-align: center; border: 1px solid black; padding: 5px; width: fit-content; margin: 0 auto;"> <p>XPM_LRD</p> <pre> REQ DONE BOOL --- ----- --- BOOL BASE STAT USINT --- ----- --- UINT SLOT L_CNT USINT --- ----- --- UINT AXIS L_DATA USINT --- ----- --- DINT[10] </pre> </div>	<p>Input</p> <p>REQ : Request for execution of function block BASE : Set the base no. with module SLOT : Set the slot no. with module AXIS : Axis to command XBF-PN04B:1~4, XBF-PN08B:1~8</p> <p>Output</p> <p>DONE : Maintain 1 after first operating STAT : Output the error no. in operation L_CNT: Number of latch position data L_DATA: Latch position data 1 ~ 10</p>

- (1) This command is used to read data count and latch position data saved and latched by the positioning module's external latch command.
- (2) Save the position data count read and latched the latch data of the axis designated as the positioning module's AXIS(Command axis) designated as BASE(Base number of the positioning module) and SLOT(Slot number of the positioning module) to L_CNT and save the latch position data to L_DATA.
- (3) You can set axis to command in "AXIS" and the following value is available. If you set other values, error code "6" appears.
 XBF-PN04B:1~4, XBF-PN08B:1~8

7.4 Parameter/Operation Data Teaching Function Block

7.4.1 Basic Parameter Teaching (XPM_SBP)

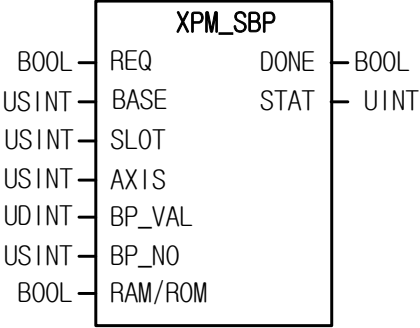
Form of Function Block	Description
	<p>Input</p> <p>REQ : Request for execution of function block BASE : Set the base no. with module SLOT : Set the slot no. with module AXIS : Axis to command XBF-PN04B:1~4, XBF-PN08B:1~8 BP_VAL : Basic parameter to change BP_NO : Item no. of basic parameter to change RAM/ROM : Method of parameter save 0: save on RAM 1: save on ROM</p> <p>Output</p> <p>DONE : Maintain 1 after first operating STAT : Output the error no. in operation</p>

- (1) Give “Basic Parameter Teaching” command to the axis designated as the axis of positioning module with BASE (Base no. of Positioning module) and SLOT (Slot no. of Positioning module).
- (2) Parameter value modified by basic parameter teaching command and setting RAM/ROM to “0” is valid within power connection. If you want to keep the parameter without power connection, execute basic parameter teaching command with setting RAM/ROM as “1” or save the modified parameter value on FRAM with XPM_WRT (Parameter/Operation Data Saving command) after basic parameter teaching.
- (3) You can set axis to command in “AXIS” and the following value is available. If you set other values, error code “6” appears.
XBF-PN04B:1~4, XBF-PN08B:1~8
- (4) Basic parameter setting command is unavailable to be executed when the axis is operating.

(5) The value that needs to be set in basic parameter is as follows.

Value	Items	Setting Range
1	Speed Limit	mm : 1 ~ 2,147,483,647 [$\times 10^{-2}$ mm/min] Inch : 1 ~ 2,147,483,647 [$\times 10^{-3}$ Inch/min] degree : 1 ~ 2,147,483,647 [$\times 10^{-3}$ degree/min] pulse : 1 ~ 2,147,483,647 [pulse/sec]
2	Acc. Time 1	1 ~ 2,147,483,647 [ms]
3	Acc. Time 2	
4	Acc. Time 3	
5	Acc. Time 4	
6	Dec. Time 1	1 ~ 2,147,483,647 [ms]
7	Dec. Time 2	
8	Dec. Time 3	
9	Dec. Time 4	
10	Emergency stop Dec. Time	1 ~ 2,147,483,647 [ms]
11	Pulse/rotation	1 ~ 200,000,000
12	Transfer /rotation	
13	Unit	0:Pulse, 1:mm, 2:Inch, 3:Degree
14	Unit mutiplier	0: x 1, 1: x 10, 2: x 100, 3: x 1000
15	Unit for speed command	0: unit/time, 1: rpm
16	Encoder selection *	0: Incremental encoder, 1: Absolute encoder
17	Current position display correction	0 ~ 255

7.4.2 Extended Parameter Teaching (XPM_SEP)

Form of Function Block	Description
	<p>Input</p> <p>REQ : Request for execution of function block BASE : Set the base no. with module SLOT : Set the slot no. with module AXIS : Axis to command XBF-PN04B:1~4, XBF-PN08B:1~8 EP_VAL : Parameter value to modify EP_NO : Item no. of parameter to modify RAM/ROM : Method for saving parameter 0: Save at RAM 1: Save at ROM</p> <p>Output</p> <p>DONE : Maintain 1 after first operating STAT : Output the error no. in operation</p>

- (1) Give “Extended Parameter Teaching” command to the axis designated as the axis of positioning module with BASE (Base no. of Positioning module) and SLOT (Slot no. of Positioning module).
- (2) Parameter value modified by extended parameter teaching command and setting RAM/ROM to “0” is valid within power connection. If you want to keep the parameter without power connection, execute extended parameter teaching command with setting RAM/ROM as “1” or save the modified parameter value on MRAM with XPM_WRT (Parameter/Operation Data Saving command) after extended parameter teaching.
- (3) You can set axis to command in “AXIS” and the following value is available. If you set other values, error code “6” appears.
XBF-PN04B:1~4, XBF-PN08B:1~8
- (4) Extended parameter setting command is unavailable to be executed when the axis is operating.

(5) The extended parameter items and setting values are as follows.

Value	Item	Setting Range
1	Software upper limit	mm :-2147483648 ~ 2147483647[X10 ⁻⁴ mm] Inch:-2147483648 ~ 2147483647[X10 ⁻⁵ Inch] degree:-2147483648 ~ 2147483647[X10 ⁻⁵ degree] pulse:-2147483648 ~ 2147483647[pulse]
2	Software lower limit	
3	-	-
4	Positioning completion time	0 ~ 65,535[ms]
5	S-Curve ratio	1 ~ 100
6	In-position width	mm: 0 ~ 65,535[X10 ⁻⁴ mm] inch: 0 ~ 65,535[X10 ⁻⁵ Inch] degree: 0 ~ 65,535[X10 ⁻⁵ degree] pulse: 0 ~ 65,535[pulse]
7	Arc insertion position	mm: 0 ~ 2147483647[X10 ⁻⁴ mm] Inch: 0 ~ 2147483647[X10 ⁻⁵ Inch] degree: 0 ~ 2147483647[X10 ⁻⁵ degree] pulse: 0 ~ 2147483647[pulse]
8	Acc./dec. pattern	0: Trapezoid operating, 1: S-curve operating
9	M code mode	0: None, 1: With, 2: After
10	ion Upper/Lower limit detect	0: Not detect, 1: Detect
11	Condition for positioning completion	0: Dwell time 1: In-position 2: Dwell time AND In-position 3: Dwell time OR In-position
12	Interpolation continuous operation type	0: Pass target position, 1: pass near position
13	2 axes linear interpolation continuous operation circular arc insertion	0: Don't insert, 1: Insert arc
14	External command selection	0: External VTP, 1: External stop
15	External command	0: Disable, 1: Enable
16	Position-specified speed override coordinate	0: Absolute, 1: Incremental
17	Infinite running repeat position	mm: 1 ~ 2147483647[X10 ⁻⁴ mm] Inch: 1 ~ 2147483647[X10 ⁻⁵ Inch] degree: 1 ~ 2147483647[X10 ⁻⁵ degree] pulse: 1 ~ 2147483647[pulse]
18	Infinite running repeat	0: disable, 1:enable
19	Speed/position switching coordinate	0: Incremental, 1: Absolute
20	Interpolation speed selection	0: main axis speed, 1: synthetic speed

7.4.3 Manual Operation Parameter Teaching (XPM_SMP)

Form of Function Block	Description
<div style="text-align: center;"> </div>	<p>Input</p> <p>REQ : Request for execution of function block BASE : Set the base no. with module SLOT : Set the slot no. with module AXIS : Axis to command XBF-PN04B:1~4, XBF-PN08B:1~8 MP_VAL : Manual operation parameter value to modify MP_NO : Item no. of manual operation parameter to modify RAM/ROM : Method for saving parameter 0: Save on RAM 1: Save on ROM</p> <p>Output</p> <p>DONE : Maintain 1 after first operation STAT : Output the error no in operation</p>

- (1) Give “Manual Operation Parameter Setting” command to the axis designated as the axis of positioning module with BASE (Base no. of Positioning module) and SLOT (Slot no. of Positioning module).
- (2) Parameter value modified by manual operation parameter teaching command and setting RAM/ROM to “0” is valid within power connection. If you want to keep the parameter without power connection, execute manual operation parameter teaching command with setting RAM/ROM as “1” or save the modified parameter value on MRAM with XPM_WRT (Parameter/Operation Data Saving command) after manual operation parameter teaching.
- (3) You can set axis to command in “AXIS” and the following value is available. If you set other values, error code “6” appears.
XBF-PN04B:1~4, XBF-PN08B:1~8
- (4) Manual operation parameter setting command is unavailable to be executed when the axis is operating.
- (5) The manual operation parameter items and setting values are as follows.

Setting Value	Items	Setting Range
1	JOG high speed	mm : 1 ~ 2,147,483,647 [$\times 10^{-2}$ mm/min] Inch : 1 ~ 2,147,483,647 [$\times 10^{-3}$ Inch/min]
2	JOG low speed	degree : 1 ~ 2,147,483,647 [$\times 10^{-3}$ degree/min] pulse : 1 ~ 2,147,483,647 [pulse/sec]
3	JOG acc. time	0 ~ 2,147,483,647 [ms]
4	JOG dec, time	
5	Inching speed	mm : 1 ~ 65,535 [$\times 10^{-2}$ mm/min] Inch : 1 ~ 65,535 [$\times 10^{-3}$ Inch/min] degree : 1 ~ 65,535 [$\times 10^{-3}$ degree/min] pulse : 1 ~ 65,535 [pulse/sec]

7.4.4 Input signal parameter teaching(XPM_SIP)

Form of Function Block	Description
<pre> graph LR subgraph XPM_SIP REQ[REQ] BASE[BASE] SLOT[SLOT] AXIS[AXIS] IP_VAL[IP_VAL] RAM_ROM[RAM/ROM] end REQ --- B1[BOOL] BASE --- U1[USINT] SLOT --- U2[USINT] AXIS --- U3[USINT] IP_VAL --- U4[UINT] RAM_ROM --- B2[BOOL] XPM_SIP --- DONE[DONE] XPM_SIP --- STAT[STAT] DONE --- B3[BOOL] STAT --- U5[UINT] </pre>	<p>Input</p> <p>REQ : Request for execution of function block BASE : Set the base no. with module SLOT : Set the slot no. with module AXIS : Axis to command XBF-PN04B:1~4, XBF-PN08B:1~8 IP_VAL : Input signal parameter value to change RAM/ROM : Setting method 0: Save on RAM 1: Save on ROM</p> <p>Output</p> <p>DONE : Maintain 1 after first operation STAT : Output the error no in operation</p>

(1) Give “Input signal parameter teaching” command to the axis designated as the axis of positioning module with BASE (Base no. of Positioning module) and SLOT (Slot no. of Positioning module).

(2) Parameter value modified by input signal parameter teaching command and setting RAM/ROM to “0” is valid within power connection. If you want to keep the parameter without power connection, execute input signal parameter teaching command with setting RAM/ROM as “1” or save the modified parameter value on MRAM with XPM_WRT (Parameter/Operation Data Saving command) after input signal parameter teaching.

(3) You can set axis to command in “AXIS” and the following value is available. If you set other values, error code “6” appears.

XBF-PN04B:1~4, XBF-PN08B:1~8

(4) Input signal parameter teaching command is unavailable to be executed when the axis is operating.

(5) The meaning of each bit of the parameter setting value of the input signal is as follows.

15	14	13	12	11 ~ 8	7 ~ 4	3 ~ 0
-	Logic selection of input signal Z	Logic selection of input signal B	Logic selection of input signal A	Function selection of input signal Z	Function selection of input signal B	Function selection of input signal A

(6) Setting value of each item are as follows.

Item of input signal parameter	Range
Function selection of input signal A	0: Unused 1: Switching speed/position control 2: Switching position/torque control 3: External operation
Function selection of input signal B	
Function selection of input signal Z	
Logic selection of input signal A	A Contact, B Contact
Logic selection of input signal B	
Logic selection of input signal Z	
Switching torque of external position/torque control	-32768 ~ 32767

7.4.5 Input signal parameter - Switching torque of external position/torque control teaching(XPM_SIPT)

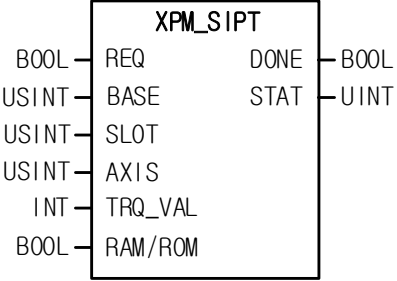
Form of Function Block	Description
	<p>Input</p> <p>REQ : Request for execution of function block BASE : Set the base no. with module SLOT : Set the slot no. with module AXIS : Axis to command XBF-PN04B:1~4, XBF-PN08B:1~8</p> <p>TRQ_VAL : Switching position/Torque control torque value to change (Unit: %, -32768 ~ 32767)</p> <p>RAM/ROM : Setting method 0: Save on RAM 1: Save on ROM</p> <p>Output</p> <p>DONE : Maintain 1 after first operation STAT : Output the error no in operation</p>

- (1) Give “Switching torque of external position/torque control teaching” command to the axis designated as the axis of positioning module with BASE (Base no. of Positioning module) and SLOT (Slot no. of Positioning module).
- (2) Parameter value modified by Switching torque of external position/torque control teaching and setting RAM/ROM to “0” is valid within power connection. If you want to keep the parameter without power connection, execute Switching torque of external position/torque control teaching command with setting RAM/ROM as “1” or save the modified parameter value on MRAM with XPM_WRT (Parameter/Operation Data Saving command) after Switching torque of external position/torque control teaching.
- (3) You can set axis to command in “AXIS” and the following value is available. If you set other values, error code “6” appears.

XBF-PN04B:1~4, XBF-PN08B:1~8

- (4) Switching torque of external position/torque control teaching command is unavailable to be executed when the axis is operating..
- (5) Setting range of torque values are as follows.
-32768 % ~ 32767 %

7.4.6 Common Parameter Teaching (XPM_SCP)

Form of Function Block	Description
<pre> graph LR subgraph XPM8_SCP REQ[REQ] BASE[BASE] SLOT[SLOT] AXIS[AXIS] CP_VAL[CP_VAL] CP_NO[CP_NO] RAM_ROM[RAM/ROM] DONE[DONE] STAT[STAT] end REQ --- B1[BOOL] BASE --- U1[USINT] SLOT --- U2[USINT] AXIS --- U3[USINT] CP_VAL --- D1[DINT] CP_NO --- U4[USINT] RAM_ROM --- B2[BOOL] DONE --- B3[BOOL] STAT --- U5[UINT] </pre>	<p>Input</p> <p>REQ : Request for execution of function block BASE : Set the base no. with module SLOT : Set the slot no. with module AXIS : Axis to command XBF-PN04B:1~4, XBF-PN08B:1~8 CP_VAL : Common parameter value to modify CP_NO : Item no. of common parameter to modify RAM/ROM : Method for saving parameter 0: Save on RAM 1: Save on ROM</p> <p>Output</p> <p>DONE : Maintain 1 after first operation STAT : Output the error no in operation</p>

- (1) Give “Common Parameter Setting” command to the axis designated as the axis of positioning module with BASE (Base no. of Positioning module) and SLOT (Slot no. of Positioning module).
- (2) Parameter value modified by common parameter teaching command and setting RAM/ROM to “0” is valid within power connection. If you want to keep the parameter without power connection, execute common parameter teaching command with setting RAM/ROM as “1” or save the modified parameter value on MRAM with XPM_WRT (Parameter/Operation Data Saving command) after common parameter teaching.
- (3) You can set axis to command in “AXIS” and the following value is available. If you set other values, error code “6” appears.

XBF-PN04B:1~4, XBF-PN08B:1~8

- (4) The common parameter items and setting values are as follows.

Setting Value	Items	Setting values
	Speed override	0 : % designation, 1 : speed designation
	Mode for encoder1 pulse input	0:CW/CCW 1 multiplication 1:PULSE/DIR 1 multiplication 2:PULSE/DIR 2 multiplication 3:PHASE A/B 1 multiplication 4:PHASE A/B 2 multiplication 5:PHASE A/B 4 multiplication
	Maximum value of encoder1	-2147483648 ~ 2147283647
	Minimum value of encoder1	
	Encoder1 Z phase clear	0 : disable, 1 : enable
10	Destination coordinates for positioning speed synchronization	0:incremental, 1:absolute,
11	Encoder 1 average number	0:None 1: 5 2:10 3:20

7.4.7 Operation Data Teaching (XPM_SMD)

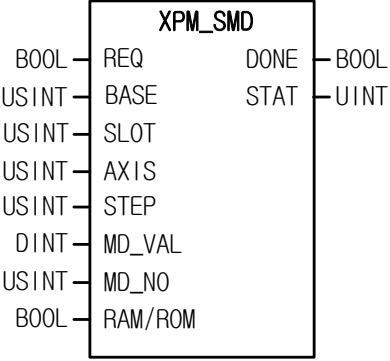
Form of Function Block	Description
 <p>The diagram shows a rectangular function block labeled 'XPM_SMD'. On the left side, there are eight input terminals: REQ (connected to a BOOL signal), BASE (connected to a USINT signal), SLOT (connected to a USINT signal), AXIS (connected to a USINT signal), STEP (connected to a USINT signal), MD_VAL (connected to a DINT signal), MD_NO (connected to a USINT signal), and RAM/ROM (connected to a BOOL signal). On the right side, there are two output terminals: DONE (connected to a BOOL signal) and STAT (connected to a UINT signal).</p>	<p>Input</p> <p>REQ : Request for execution of function block BASE : Set the base no. with module SLOT : Set the slot no. with module AXIS : Axis to command XBF-PN04B:1~4, XBF-PN08B:1~8 STEP : Step no. to modify 0 ~ 400 MD_VAL : Operation data value to modify MD_NO : Item no. of operation data to modify RAM/ROM : Method for saving parameter 0: Save on RAM 1: Save on ROM</p> <p>Output</p> <p>DONE : Maintain 1 after first operation STAT : Output the error no in operation</p>

- (1) Give "Operation Data Teaching" command to the axis designated as the axis of positioning module with BASE (Base no. of Positioning module) and SLOT (Slot no. of Positioning module).
- (2) Parameter value modified by operation data teaching command and setting RAM/ROM to "0" is valid within power connection. If you want to keep the parameter without power connection, execute operation data teaching command with setting RAM/ROM as "1" or save the modified parameter value on MRAM with XPM_WRT (Parameter/Operation Data Saving command) after operation data teaching.
- (3) You can set axis to command in "AXIS" and the following value is available. If you set other values, error code "6" appears.
XBF-PN04B:1~4, XBF-PN08B:1~8
- (4) Operation data setting command is available to be executed when the axis is operating. However, if operation data of the step that is currently operated are changed, those changes are reflected after the current step is completed.

(5) The operation data items and setting values are as follows.

Setting value	Items	Setting Range																
1	Goal position	mm : -2147483648 ~ 2147483647 [$\times 10^{-4}$ mm] Inch : -2147483648 ~ 2147483647 [$\times 10^{-5}$ Inch] degree : -2147483648 ~ 2147483647 [$\times 10^{-5}$ degree] pulse : -2147483648 ~ 2147483647 [pulse]																
2	Auxiliary position for circular interpolation	-2147483648 ~ 2147483647																
3	Operating speed	mm : 1 ~ 2,147,483,647 [$\times 10^{-2}$ mm/min] Inch : 1 ~ 2,147,483,647 [$\times 10^{-3}$ Inch/min] degree : 1 ~ 2,147,483,647 [$\times 10^{-3}$ degree/min] pulse : 1 ~ 2,147,483,647 [pulse/sec]																
4	Dwell time	0 ~ 65,535[ms]																
5	M code no.	0 ~ 65,535																
6	Sub axis setting	Bit unit setting <table border="1"> <thead> <tr> <th>Bit 7</th> <th>Bit 6</th> <th>Bit 5</th> <th>Bit 4</th> <th>Bit 3</th> <th>Bit 2</th> <th>Bit 1</th> <th>Bit 0</th> </tr> </thead> <tbody> <tr> <td>axis8</td> <td>axis7</td> <td>axis6</td> <td>axis5</td> <td>axis4</td> <td>axis3</td> <td>axis2</td> <td>axis1</td> </tr> </tbody> </table>	Bit 7	Bit 6	Bit 5	Bit 4	Bit 3	Bit 2	Bit 1	Bit 0	axis8	axis7	axis6	axis5	axis4	axis3	axis2	axis1
Bit 7	Bit 6	Bit 5	Bit 4	Bit 3	Bit 2	Bit 1	Bit 0											
axis8	axis7	axis6	axis5	axis4	axis3	axis2	axis1											
7	Helical interpolation axis	0, axis1 ~ axis8 (0: General circular interpolation)																
8	Circular interpolation turns	0~65,535																
9	Coordinate	0: absolute, 1: incremental																
10	Control method	0:single-axis position control, 1:single axis speed control, 2:single- axis Feed control, 3:linear interpolation, 4:circular interpolation																
11	Operating method	0:single, 1:repeat																
12	Operating pattern	0:end, 1:keep, 2:continue																
13	Size of circular arc	0:circular arc<180 1:circular arc>=180																
14	Acc. No.	0 ~ 3																
15	Dec. No.	0 ~ 3																
16	Circular interpolation mode	0:middle point, 1:center point, 2:radius																
17	Direction of circular interpolation	0:CW, 1:CCW																

7.4.8 Teaching Array (XPM_ATEA)

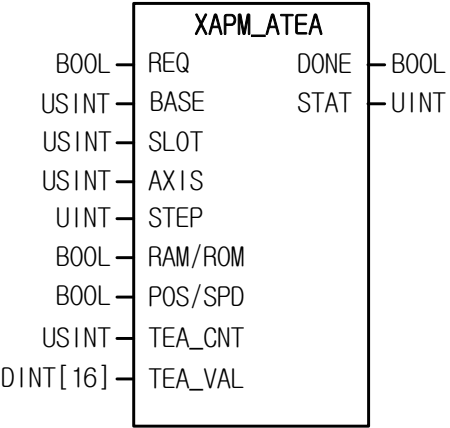
Form of Function Block	Description
	<p>Input</p> <p>REQ : Request for execution of function block BASE : Set the base no. with module SLOT : Set the slot no. with module AXIS : Axis to command XBF-PN04B:1~4, XBF-PN08B:1~8 STEP : Set the step no. to do teaching 0 ~ 400 RAM/ROM : Selection of RAM/ROM teaching 0 : RAM teaching, 1 : ROM teaching POS/SPD : Selection of position/speed teaching 0 : Position, 1 : Speed TEA_CNT : Set the no. of data to do teaching 1 ~ 16 TEA_VAL : Set the teaching value</p> <p>Output</p> <p>DONE : Maintain 1 after first operation STAT : Output the error no in operation</p>

- (1) Give "Teaching Array" command to the axis designated as the axis of positioning module with BASE (Base no. of Positioning module) and SLOT (Slot no. of Positioning module).
- (2) Speed teaching is for user to use random speed value in a operation data of specified step and position teaching is for user to use random position value in a operation data of specified operation step.
- (3) This command is for modifying maximum 16 goal positions/speed value at once with teaching array function block.
- (4) You can set axis to command in "AXIS" and the following value is available. If you set other values, error code "6" appears.
XBF-PN04B:1~4, XBF-PN08B:1~8
- (5) Even "Write variable data" command can be executed even when the axis subject to teaching is being operated but, only the current step's data is reflected after the current step operation is completed if the step that is currently running is within the step area while other steps' data are immediately changed.
- (6) You may set step no.(0~400) of operation data on STEP. If you set wrongly, "Error11" arises.
- (7) You may set the no. of data to do teaching on TEA_CNT and do teaching max. 16. If you set wrongly, "Error11" arises.
- (8) Parameter value modified by teaching command and setting RAM/ROM as "0" is valid within power connection. If you want to keep the parameter without power connection, execute teaching command with setting "1" on RAM/ROM or save the modified parameter value on MRAM with XPM_WRT (Parameter/Operation Data Saving command) after teaching.

7.4.9 Read Variable Data (XPM_VRD)

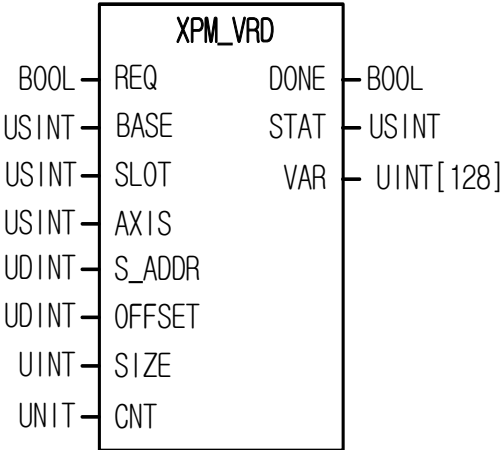
Form of Function Block	Description
 <p>The diagram shows a central box labeled 'XPM_VRD'. On the left side, there are input terminals: REQ (connected to a BOOL variable), BASE (connected to a USINT variable), SLOT (connected to a USINT variable), AXIS (connected to a USINT variable), S_ADDR (connected to a UDINT variable), OFFSET (connected to a UDINT variable), SIZE (connected to a UINT variable), and CNT (connected to a UINT variable). On the right side, there are output terminals: DONE (connected to a BOOL variable), STAT (connected to a USINT variable), and VAR (connected to a UINT[128] variable).</p>	<p>Input</p> <p>REQ : Request for execution of function block BASE : Set the base no. with module SLOT : Set the slot no. with module AXIS : Axis to command XBF-PN04B:1~4, XBF-PN08B:1~8 S_ADDR : Module internal memory head address of Read Data 0 ~ 72793 OFFSET : Offset between Read Data blocks 0 ~ 72793 SIZE : Block size of Read data 1 ~ 128 CNT : No. of Read Data block 1 ~ 128</p> <p>Output</p> <p>DONE : Maintain 1 after first operation STAT : Output the error no. in operation VAR : PLC device where Read Data is saved</p>

- (1) Gives “Read parameter, operation data, CAM data directly” command to positioning module.
- (2) You read data you want by designating module internal memory address of parameter, operation data, CAM data directly.
- (3) It reads the positioning module internal memory from the position set by “S_ADDR” by WORD unit and save them in the device set by “VAR”. The number of data to read is the number set by “Size”. In case “CNT” is larger than 2, it reads multiple data blocks and save them in the device set by “VAR” in order. At this time, head address of next block is “Offset” apart from head address of current block.
- (4) Max. data size (SIZE x CNT) you can read with one command is 128 WORD.
- (5) “Read Variable Data” command can be executed in operation.
- (6) You can set axis to command in “AXIS” and the following value is available. If you set other values, error code “6” appears.

XBF-PN04B:1~4, XBF-PN08B:1~8
- (7) In case Read Data size (SIZE x CNT) is 0 or higher than 128 WORD, error code “11” appears in STAT.
- (8) Don’t use XPM_VRD command at the same time. That is, you must execute a command after the other command’s operation completes. Please note that the command don’t execute at the same time in case the command axis is same or not.

7.4.10 Write Variable Data (XPM_VWR)

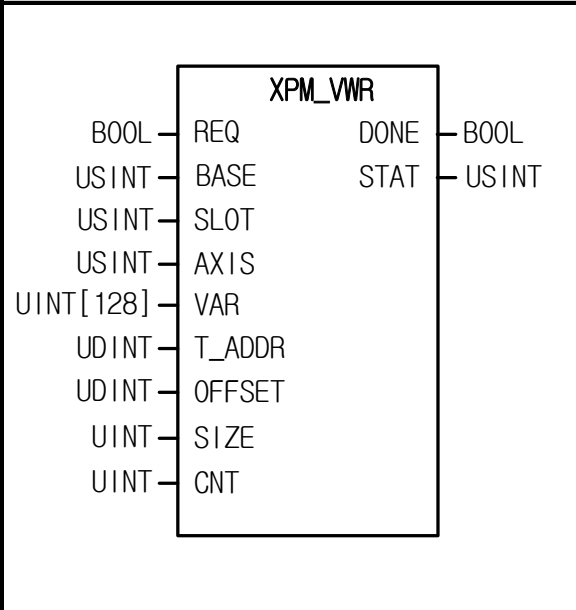
Form of Function Block	Description
	<p>Input</p> <p>REQ : Request for execution of function block BASE : Set the base no. with module SLOT : Set the slot no. with module AXIS : Axis to command 1 ~ 8: axis 1 ~ axis 8 VAR : PLC device where Write Data is saved T_ADDR : Module internal memory head address where data is written 0 ~ 72793 OFFSET : Offset between Write data blocks 0 ~ 72793 SIZE : Size of block to write 1 ~ 128 CNT : No. of Write data block 1 ~ 128</p> <p>Output</p> <p>DONE : Maintain 1 after first operation STAT : Output the error no. in operation</p>

- (1) Gives "Write parameter, operation data, CAM data directly" command to positioning module.
- (2) You can write data you want by designating module internal memory address of parameter, operation data, CAM data directly.
- (3) It writes the WORD data in "VAR" to module internal memory. The data are saved from internal memory position set by "T_ADDR" and the number of data is the number set by "Size". In case the number of block "CNT" is larger than 2, multiple blocks are made. At this time, head address of next block is "Offset" apart from head address of current block.
- (4) Max. data size (SIZE x CNT) you can write with one command is 128 WORD.
- (5) "Write Variable Data" command can't be executed in operation.
- (6) You can set axis to command in "AXIS" and the following value is available. If you set other values, error code "6" appears.
1 ~ 8: axis 1 ~ axis 8
- (7) In case Read Data size (SIZE x CNT) is 0 or higher than 128 WORD, error code "11" appears in STAT
- (8) In case no. of block (CNT) is higher than 2, and block offset is smaller than block size, error code "11" appears in STAT because module internal memory block to write is overlapped each other.
- (9) Don't use XPM_VWR command at the same time. That is, you must execute a command after the other command's operation completes. Please note that the command don't execute at the same time in case the command axis is same or not.

7.4.11 Saving Parameter/Operation Data (XPM_WRT)

Form of Function Block	Description
<pre> graph LR subgraph XPM_WRT REQ[REQ] BASE[BASE] SLOT[SLOT] AXIS[AXIS] WRT_AXIS[WRT_AXIS] DONE[DONE] STAT[STAT] end REQ --- XPM_WRT BASE --- XPM_WRT SLOT --- XPM_WRT AXIS --- XPM_WRT WRT_AXIS --- XPM_WRT XPM_WRT --- DONE XPM_WRT --- STAT </pre>	<p>Input</p> <p>REQ : Request for execution of function block BASE : Set the base no. with module SLOT : Set the slot no. with module AXIS : Axis to command XBF-PN04B:1~4, XBF-PN08B:1~8 XPM_WRT_AXIS : Saving axis setting (by setting bit) 0bit ~ 7bit: axis1 ~ axis8</p> <p>Output</p> <p>DONE : Maintain 1 after first operation STAT : Output the error no in operation</p>

(1) Give “Basic Parameter Setting” command to the axis designated as the axis of positioning module with BASE (Base no. of positioning module) and SLOT (Slot no. of positioning module).

(2) You can set axis to command in “AXIS” and the following value is available. If you set other values, error code “6” appears.

XBF-PN04B:1~4, XBF-PN08B:1~8

(3) If function block is executed normally, the current operation parameter and data which saved on WRT_AXIS are saved on MRAM and maintain the data without the power connection.

(4) For setting WRT_AXIS, set each Bit

15 ~ 8 Bit	7Bit	6Bit	5Bit	4Bit	3Bit	2Bit	1Bit	0Bit
Not Used	Axis 8	Axis 7	Axis 6	Axis 5	Axis 4	Axis 3	Axis 2	Axis 1

If you want to select axis3, axis5 and axis6, just set to “16#34”

(5) In case of modifying the CAM data with XPM_VWR instruction, when you execute XPM_WRT, the modified data will be saved in FLASH.

7.5 Start/Stop Function Block

7.5.1 Homing Start (XPM_ORG)

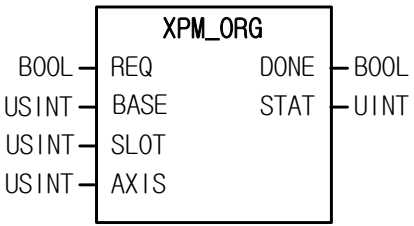
Form of Function Block	Description
	<p>Input</p> <p>REQ : Request for execution of function block BASE : Set the base no. with module SLOT : Set the slot no. with module AXIS : Axis to command XBF-PN04B:1~4, XBF-PN08B:1~8</p> <p>Output</p> <p>DONE : Maintain 1 after first operation STAT : Output the error no in operation</p>

- (1) This is the command that give homing command to APM module.
- (2) This is the command to find the origin of machine by Direction, Correction, Speed, Address and Dwell set on parameter of each axis for homing according to the homing access.
- (3) Give "Homing" command to the axis designated as the axis of positioning module with BASE (Base no. of Positioning module) and SLOT (Slot no. of Positioning module).
- (4) You can set axis to command in "AXIS" and the following value is available. If you set other values, error code "6" appears.
XBF-PN04B:1~4, XBF-PN08B:1~8
- (5) If homing command is executed normally, it starts homing according to "homing method" of "homing parameter".

7.5.2 Direct Start (XPM_DST)

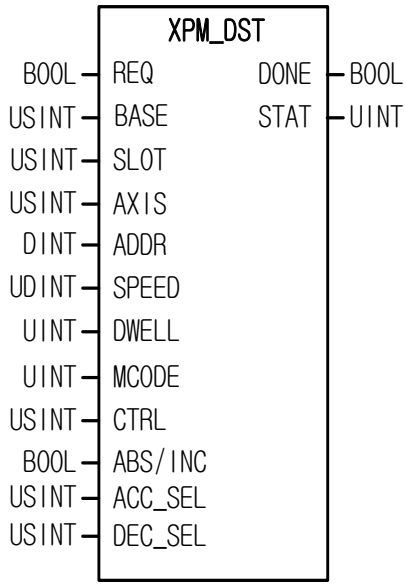
Form of Function Block	Description
 <p>The diagram shows a rectangular function block labeled 'XPM_DST'. On the left side, there are 14 input terminals with the following labels and data types: REQ (BOOL), BASE (USINT), SLOT (USINT), AXIS (USINT), ADDR (DINT), SPEED (UDINT), DWELL (UINT), MCODE (UINT), CTRL (USINT), ABS/INC (BOOL), ACC_SEL (USINT), and DEC_SEL (USINT). On the right side, there are two output terminals: DONE (BOOL) and STAT (UINT).</p>	<p>Input</p> <p>REQ : Request for execution of function block BASE : Set the base no. with module SLOT : Set the slot no. with module AXIS : Axis to command XBF-PN04B:1~4, XBF-PN08B:1~8 ADDR : Goal position address setting -2147483648 ~ +2147483647 SPEED : Goal speed setting DWELL : Dwell time setting 0 ~ 65535[ms] M code : M code value setting CTRL : Control method setting 0: Position, 1: Speed, 2: Feed 3: Shortest Position ABS/INC: Coordinate setting 0: Absolute, 1: Incremental ACC_SEL: Acc.time no. setting 0: Acc. Time 1, 1: Acc. Time 2 2: Acc. Time 3, 3: Acc. Time 4 DCC_SEL: Dec.time no. setting 0: Dec. time 1, 1: Dec. time 2 2: Dec. time 3, 3: Dec. time 4</p> <p>Output</p> <p>DONE : Maintain 1 after first operation STAT : Output the error no in operation</p>

- (1) Give "Direct Start" command to the axis designated as the axis of positioning module with BASE (Base no. of Positioning module) and SLOT (Slot no. of Positioning module).
- (2) This is for operating by setting goal position address, operation speed, dwell time, M code, control method, coordinates setting and no. of Acc./Dec time, not by operation data.
- (3) You can set axis to command in "AXIS" and the following value is available. If you set other values, error code "6" appears.
 XBF-PN04B:1~4, XBF-PN08B:1~8
- (4) If the value set on SPEED, CTRL, TIME_SEL is out of setting range, "Error11" will occur on STAT.

7.5.3 Indirect Start (XPM_IST)

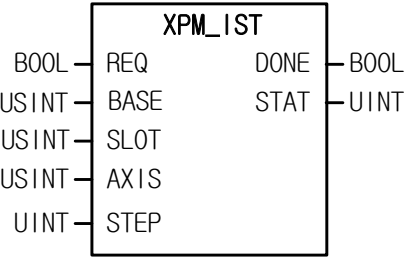
Form of Function Block	Description
	<p>Input</p> <p>REQ : Request for execution of function block BASE : Set the base no. with module SLOT : Set the slot no. with module AXIS : Axis to command XBF-PN04B:1~4, XBF-PN08B:1~8 STEP : Set the step no. to do teaching 0 ~ 400</p> <p>Output</p> <p>DONE : Maintain 1 after first operation STAT : Output the error no in operation</p>

- (1) Give "Indirect Start" command to the axis designated as the axis of positioning module with BASE (Base no. of Positioning module) and SLOT (Slot no. of Positioning module).
- (2) This is for operating by setting operation step no. of axis which set as an operation data.
- (3) You can set axis to command in "AXIS" and the following value is available. If you set other values, error code "6" appears.
XBF-PN04B:1~4, XBF-PN08B:1~8
- (4) If the value set on STEP is out of the setting range (0~400), "Error11" arises on STAT.
- (5) If set STEP to 0, it operates the current step.
- (6) Linear interpolation, circular interpolation and helical interpolation are executed in indirect start by setting the control method.

7.5.4 Ellipse Interpolation (XPM_ELIN)

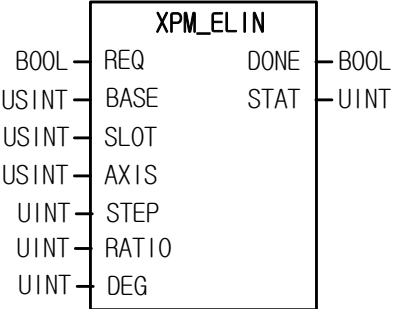
Form of Function Block	Description
	<p>Input</p> <p>REQ : Request for execution of function block BASE : Set the base no. with module SLOT : Set the slot no. with module AXIS : Axis to command XBF-PN04B:1~4, XBF-PN08B:1~8 STEP : Step no. to operate RATIO : Ellipse ratio(%) DEG : Operating angle</p> <p>Output</p> <p>DONE : Maintain 1 after first operation STAT : Output the error no in operation</p>

- (1) Give “Ellipse Interpolation” command to the axis designated as the axis of positioning module with BASE (Base no. of Positioning module) and SLOT (Slot no. of Positioning module).
- (2) This is the command that execute ellipse interpolation to the designated step as much as the angle set on DEG in the ratio of it which set on RATIO.
- (3) Ellipse interpolation is that distort operation data of the step already set at the rate already set on RATIO to execute ellipse interpolation. Therefore, the step of operation data set on STEP has to be set in accordance with circular interpolation control.
- (4) Ellipse rate range from 1 to 65535, it has [X10⁻²%] as its unit. If you set 65535, the rate will be 655.35%.
- (5) Operation angle range from 1 to 65535, it has [X10⁻¹ degree] as its unit. If you set 3650, the angle will be 365.0
- (6) You can set axis to command in “AXIS” and the following value is available. If you set other values, error code “6” appears.
 XBF-PN04B:1~4, XBF-PN08B:1~8

7.5.5 Simultaneous Start (XPM_SST)

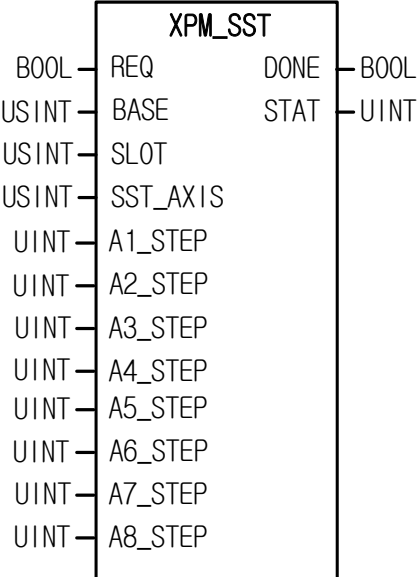
Form of Function Block	Description
 <p>The diagram shows a rectangular function block labeled 'XPM_SST'. On the left side, there are inputs: a 'REQ' input (labeled 'BOOL' above it), 'BASE' (labeled 'USINT' above it), 'SLOT' (labeled 'USINT' above it), 'SST_AXIS' (labeled 'USINT' above it), and eight 'A1_STEP' through 'A8_STEP' inputs (each labeled 'UINT' above it). On the right side, there are outputs: 'DONE' (labeled 'BOOL' above it) and 'STAT' (labeled 'UINT' above it).</p>	<p>Input</p> <p>REQ : Request for execution of function block BASE : Set the base no. with module SLOT : Set the slot no. with module SST_AXIS : Simultaneous axis setting 0bit ~ 7bit: axis1 ~ axis8 Set bit of each axis to select A1_STEP : step no. of axis1 to start A2_STEP : step no. of axis2 to start A3_STEP : step no. of axis3 to start A4_STEP : step no. of axis4 to start A5_STEP : step no. of axis5 to start A6_STEP : step no. of axis6 to start A7_STEP : step no. of axis7 to start A8_STEP : step no. of axis8 to start</p> <p>Output</p> <p>DONE : Maintain 1 after first operation STAT : Output the error no in operation</p>

- (1) Give "Simultaneous Start" command to the axis designated as the axis of positioning module with BASE (Base no. of Positioning module) and SLOT (Slot no. of Positioning module).
- (2) This is for starting more than 2 axes at once.
- (3) If you set a value out of setting range, "Error6" arises. Set with each bit as follows.

7bit	6bit	5bit	4bit	3bit	2bit	1bit	0bit
Axis8	Axis7	Axis6	Axis5	Axis4	Axis3	Axis2	Axis1

- (4) Set the step no. of each axis to execute simultaneous start on A1_STEP ~ A8_STEP.

7.5.6 Point Start (XPM_PST)

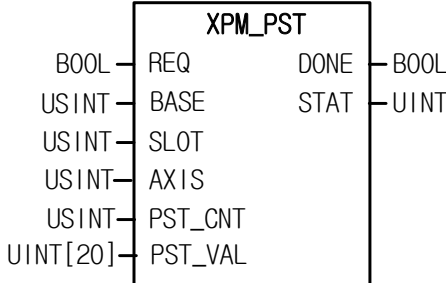
Form of Function Block	Description
 <p>The diagram shows a central box labeled 'XPM_PST'. On the left side, there are input lines: a 'BOOL' line for 'REQ', 'USINT' lines for 'BASE', 'SLOT', and 'AXIS', a 'USINT' line for 'PST_CNT', and a 'UINT[20]' line for 'PST_VAL'. On the right side, there are output lines: a 'BOOL' line for 'DONE' and a 'UINT' line for 'STAT'.</p>	<p>Input</p> <ul style="list-style-type: none"> REQ : Request for execution of function block BASE : Set the base no. with module SLOT : Set the slot no. with module AXIS : Axis to command XBF-PN04B:1~4, XBF-PN08B:1~8 PST_CMT : Set the no. of step for point operation 1 ~ 19 PST_VAL : Set the step no. for point operation 0 ~ 400 <p>Output</p> <ul style="list-style-type: none"> DONE : Maintain 1 after first operation STAT : Output the error no in operation

- (1) Give "Point start" command to the axis designated as the axis of positioning module with BASE (Base no. of Positioning module) and SLOT (Slot no. of Positioning module).
- (2) You can set axis to command in "AXIS" and the following value is available. If you set other values, error code "6" appears.
XBF-PN04B:1~4, XBF-PN08B:1~8
- (3) This is for when operating PTP(Point to Point), operate continuously by setting max. 20 operation steps.
- (4) Point operation may be executed with max. 20 point steps. Therefore, you may use the parameter which has 20 elements and like UNIT arrangement.

7.5.7 Deceleration Stop (XPM_STP)

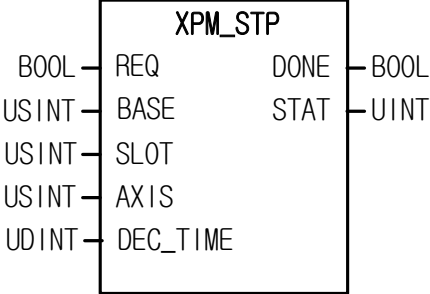
Form of Function Block	Description
	<p>Input</p> <p>REQ : Request for execution of function block BASE : Set the base no. with module SLOT : Set the slot no. with module AXIS : Axis to command XBF-PN04B:1~4, XBF-PN08B:1~8 DEC_TIME : Decelerating stop time 0: Acc./Dec. time applied when start operating 1 ~ 2147483647: 1 ~ 2147483647ms</p> <p>Output</p> <p>DONE : Maintain 1 after first operation STAT : Output the error no in operation</p>

- (1) Give “Decelerating Stop” command to the axis designated as the axis of positioning module with BASE (Base no. of Positioning module) and SLOT (Slot no. of Positioning module).
- (2) If receive the stop command by operation data, it will stop operating and continue to operate by start command.
- (3) If “Decelerating Stop” is executed in speed/position synchronization or CAM operation, speed/position synchronization or CAM operation will stop depending on the state of the current operation control.
- (4) “Decelerating Stop” may be executed in not only acc./dec. area but also steady speed area.
- (5) Deceleration time means the time between the point of start decelerating and the point of stop and may be set to 0 ~ 2,147,483,647ms. But, if it is set to “0”, it will stop by the time set at the starting of operation.
- (6) Deceleration time means the time between the speed limit of basic parameter and stop.
- (7) You can set axis to command in “AXIS” and the following value is available. If you set other values, error code “6” appears.

XBF-PN04B:1~4, XBF-PN08B:1~8

7.5.8 Emergency Stop (XPM_EMG)

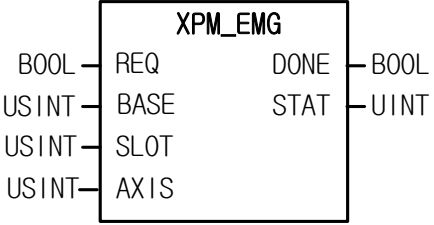
Form of Function Block	Description
	<p>Input</p> <p>REQ : Request for execution of function block BASE : Set the base no. with module SLOT : Set the slot no. with module AXIS : Axis to command XBF-PN04B:1~4, XBF-PN08B:1~8</p> <p>Output</p> <p>DONE : Maintain 1 after first operating STAT : Output the error no. in operation</p>

- (1) Give “Emergency Stop” command to the axis designated as the axis of positioning module with BASE (Base no. of Positioning module) and SLOT (Slot no. of Positioning module).
- (2) This command is for immediate stop. The axis to execute this command will stop.
- (3) Dec. time of emergent stop is the time set on “Dec. time of Emergent stop” of basic parameter.
- (4) You can set axis to command in “AXIS” and the following value is available. If you set other values, error code “6” appears. XBF-PN04B:1~4, XBF-PN08B:1~8

7.5.9 Restart (XPM_RSTR)

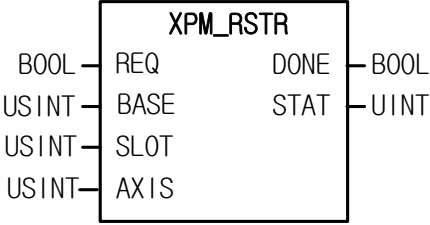
Form of Function Block	Description
	<p>Input</p> <p>REQ : Request for execution of function block BASE : Set the base no. with module SLOT : Set the slot no. with module AXIS : Axis to command XBF-PN04B:1~4, XBF-PN08B:1~8</p> <p>Output</p> <p>DONE : Maintain 1 after first operating STAT : Output the error no. in operation</p>

- (1) Give "Restart" command to the axis of positioning module designated by BASE (Base no. of Positioning module) and SLOT (Slot no. of Positioning module).
- (2) This command is used when restarting the axis which stops by EMG stop command. If this command is executed, the axis operates again with previous operating information.
- (3) If you start the axis with commands other than "Restart" after it stops with DEC. stop, "Restart" will not be executed
- (4) You can set axis to command in "AXIS" and the following value is available. If you set other values, error code "6" appears.
XBF-PN04B:1~4, XBF-PN08B:1~8
- (5) For detailed information on "Restart", refer to "9.2.20. Restart".
- (6) If the command changing current operation is executed except for DEC. stop, "Restart" will not be executed.
- (7) It is impossible to execute the "Restart" in case of continuous operation, circular interpolation, home and all operation of sub axis.

7.5.10 Torque Control (XPM_TRQ)

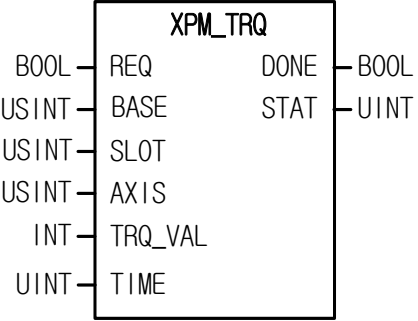
Form of Function Block	Description
 <p>The diagram shows a rectangular function block labeled 'XPM_TRQ'. On the left side, there are seven input terminals: 'REQ' (connected to a 'BOOL' variable), 'BASE' (connected to a 'USINT' variable), 'SLOT' (connected to a 'USINT' variable), 'AXIS' (connected to a 'USINT' variable), 'TRQ_VAL' (connected to an 'INT' variable), and 'TIME' (connected to a 'UINT' variable). On the right side, there are two output terminals: 'DONE' (connected to a 'BOOL' variable) and 'STAT' (connected to a 'UINT' variable').</p>	<p>Input</p> <p>REQ : Request for execution of function block BASE : Set the base no. with module SLOT : Set the slot no. with module AXIS : Axis to command XBF-PN04B:1~4, XBF-PN08B:1~8 TRQ_VAL: Torque value (unit: %, -32768 ~ 32767) TIME: Torque gradient (unit: ms, 0 ~ 65535 ms)</p> <p>Output</p> <p>DONE : Maintain 1 after first operating STAT : Output the error no. in operation</p>

- (1) Give "Torque Control" command to the axis of positioning module designated by BASE (Base no. of Positioning module) and SLOT (Slot no. of Positioning module).
- (2) Torque control executes if torque value and torque gradient are set and a command is issued.
- (3) Set torque value (%) to TRQ_VAL. Torque values work in % rated torque. (1 = 1% of rated torque)
 For example, set 200 if the user wants to control torque in 200% of torque.
- ※ The allowable range of torque value may vary according to the connected servo drive. In general, target torque value is limited to the maximum torque setting.
- (4) Set time to take in reaching the target torque to TIME. If a command is executed, torque increases in this gradient until it reaches the set torque value.
- (5) Any command cannot be executed, the relevant axis is being operated for functions other than torque control.
- (6) You can set axis to command in "AXIS" and the following value is available. If you set other values, error code "6" appears.
 XBF-PN04B:1~4, XBF-PN08B:1~8
- (7) For detailed information on "Torque Control", refer to "9.2.21. Torque Control".

7.5.11 Control Speed Limit Torque (XPM_TRQSL)

Function Block type	Content
	<p>Input</p> <p>REQ: Request the execution of function blocks BASE: Set the number of a base equipped with a module SLOT: Set the number of a slot equipped with a module AXIS: Designate the axis of command execution TRQ_VAL: Torque Value (Unit: 0.1%, -32768 ~ 32767) TIME : Torque Slope (Unit: ms, 0~65535ms) SPD_LIMIT: Speed Limit Value (Unit: rpm, 0~6000)</p> <p>Output</p> <p>DONE: Maintain 1 after initial operation STAT: Output an error code that occurred during the execution of function blocks</p>

(1) It is a command to conduct torque control below the speed set to AXIS (command axis) of a positioning module designated by BASE (the base number of a positioning module) and SLOT (the slot number of a positioning module).

(2) If giving a command after setting torque values, torque slopes and speed limit values, torque control is performed.

※ The command applies only to the LS Electric Servo Drive family.

(3) Set the torque value to TRQ_VAL The torque value operates by 0.1% of rated torque. (1 = 0.1% of rated torque) For example, set the TRQ_VAL to 2000 if you perform torque control by 200% of rated torque.

※ Tolerances on the torque values are varied according to types of the connected servo drive.

Generally the targeted torque value is limited to the maximum torque setting.

(4) TIME sets the time to arrive the targeted torque. When the command is performed, the torque is increased to the torque value set to TRQ_VAL with this slope.

(5) SPD_LIMIT, the speed limit value, is set to the 'speed limit value upon torque control' parameter of the servo drive. Therefore, it operates by the maximum speed value during torque rotation.

(5) When the corresponding axis is operating except torque control, the torque control can not be performed.

(6) The axis of command execution is set to AXIS and the following values can be set to it: When setting values other than the setting value, "Error Code 6" occurs.

XBF-PN04B: 1-4 (Axis 1-Axis 4), XBF-PN08B: 1-8 (Axis 1-Axis 8)

(7) Supported versions of the Function Block are as follows:

- XBF-PN04B/PN08B OS: V1.80 or higher
- XG5000: V4.28 or higher

7.6 Manual Operation Function Block

7.6.1 JOG Operation (XPM_JOG)

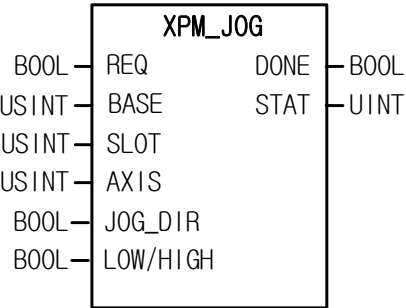
Form of Function Block	Description
 <p>The diagram shows a rectangular function block labeled 'XPM_JOG'. On the left side, there are six input terminals: 'REQ' (labeled 'BOOL'), 'BASE' (labeled 'USINT'), 'SLOT' (labeled 'USINT'), 'AXIS' (labeled 'USINT'), 'JOG_DIR' (labeled 'BOOL'), and 'LOW/HIGH' (labeled 'BOOL'). On the right side, there are two output terminals: 'DONE' (labeled 'BOOL') and 'STAT' (labeled 'UINT').</p>	<p>Input</p> <ul style="list-style-type: none"> REQ : Request for execution of function block BASE : Set the base no. with module SLOT : Set the slot no. with module AXIS : Axis to command XBF-PN04B:1~4, XBF-PN08B:1~8 JOG_DIR : Set the direction of JOG operation 0:Forward, 1:Reverse LOW/HIGH : Set the speed of JOG operation 0:Low speed, 1:High speed <p>Output</p> <ul style="list-style-type: none"> DONE : Maintain 1 after first operating STAT : Output the error no. in operation

- (1) Give “JOG Operation” command to the axis designated as the axis of positioning module with BASE (Base no. of Positioning module) and SLOT (Slot no. of Positioning module).
- (2) This command is for checking operation of system, wiring and address for teaching. It may be used in High/Low speed.
- (3) The operating condition of JOG operation function block is Level type. That is, when the condition of input parameter (REQ) is ON, pulse is outputted by setting value.
- (4) If the value of LOW/HIGH is changed, the speed will be changed without stop and if the value of JOG_DIR is changed, it will change the direction after decelerating stop.
- (5) You can set axis to command in “AXIS” and the following value is available. If you set other values, error code “6” appears.
XBF-PN04B:1~4, XBF-PN08B:1~8

7.6.2 Inching Operation (XPM_INC)

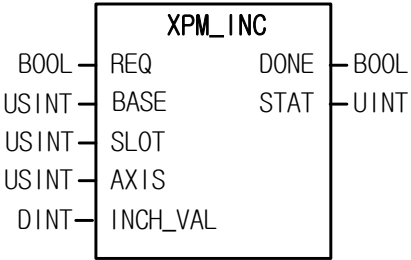
Form of Function Block	Description
	<p>Input</p> <p>REQ : Request for execution of function block BASE : Set the base no. with module SLOT : Set the slot no. with module AXIS : Axis to command XBF-PN04B:1~4, XBF-PN08B:1~8 INCH_VAL: Amount of movement by Inching Operation -2,147,483,648 ~ 2,147,483,647</p> <p>Output</p> <p>DONE : Maintain 1 after first operating STAT : Output the error no. in operation</p>

- (1) Give “Inching Operation” command to the axis designated as the axis of positioning module with BASE (Base no. of Positioning module) and SLOT (Slot no. of Positioning module).
- (2) This command is a kind of manual operation for process a minute movement as an operation of fixed amount.
- (3) Speed of inching operation is set on manual operation parameter.
- (4) You can set axis to command in “AXIS” and the following value is available. If you set other values, error code “6” appears.
XBF-PN04B:1~4, XBF-PN08B:1~8

7.6.3 Returning to Position before Manual Operation (XPM_RTP)

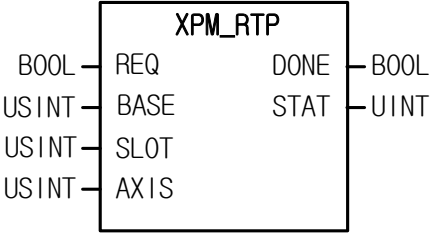
Form of Function Block	Description
	<p>Input</p> <p>REQ : Request for execution of function block BASE : Set the base no. with module SLOT : Set the slot no. with module AXIS : Axis to command XBF-PN04B:1~4, XBF-PN08B:1~8</p> <p>Output</p> <p>DONE : Maintain 1 after first operating STAT : Output the error no. in operation</p>

- (1) Give “Returning to position before manual operation” command to the axis designated as the axis of positioning module with BASE (Base no. of Positioning module) and SLOT (Slot no. of Positioning module).
- (2) When the position is changed by manual operation, this command may move the axis to previous manual operation position.
- (3) You can set axis to command in “AXIS” and the following value is available. If you set other values, error code “6” appears.
 XBF-PN04B:1~4, XBF-PN08B:1~8

7.7 Synchronization Start Function Blocks

7.7.1 Position Synchronization (XPM_SSP)

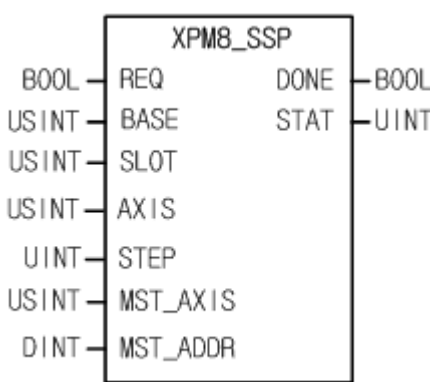
Form of Function Block	Description
	<p>Input</p> <p>REQ : Request for execution of function block BASE : Set the base no. with module SLOT : Set the slot no. with module AXIS : Axis to command XBF-PN04B:1~4, XBF-PN08B:1~8 STEP : Step no. to operate 0 ~ 400 MST_AXIS : Set the main axis XBF-PN04B:1~4, XBF-PN08B:1~8, 9: Encoder1 MST_ADDR : Set the position of main axis -2,147,483,648 ~ 2,147,483,647</p> <p>Output</p> <p>DONE : Maintain 1 after first operating STAT : Output the error no. in operation</p>

- (1) Give "Synchronization Start" command to the axis designated as the axis of positioning module with BASE (Base no. of Positioning module) and SLOT (Slot no. of Positioning module).
- (2) Operate operation step set by command axis after main axis comes to the position of synchronization.
- (3) You can set axis to command in "AXIS" and the following value is available. If you set other values, error code "6" appears.
XBF-PN04B:1~4, XBF-PN08B:1~8
- (4) You may set the main axis on MST_AXIS with following values. If you set wrongly, "Error6" arises.
XBF-PN04B:1~4, XBF-PN08B:1~8, 9 : Encoder1

7.7.2 Speed Synchronization (XPM_SSS)

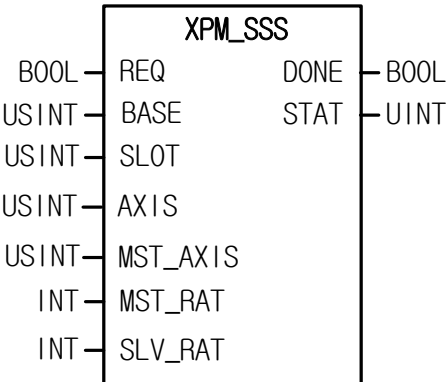
Form of Function Block	Description
	<p>Input</p> <p>REQ : Request for execution of function block BASE : Set the base no. with module SLOT : Set the slot no. with module AXIS : Axis to command XBF-PN04B:1~4, XBF-PN08B:1~8 MST_AXIS : Set main axis XBF-PN04B:1~4, XBF-PN08B:1~8, 9: Encoder1, MST_RAT : Set speed rate of main axis -32,768 ~ 32,767 SLV_RAT : Set speed rate of sub axis -32,768 ~ 32,767</p> <p>Output</p> <p>DONE : Maintain 1 after first operating STAT : Output the error no. in operation</p>

- (1) This is "Speed Synchronization" command to designated BASE (Base no. of Positioning module) and SLOT (Slot no. of Positioning module).
- (2) This command is for operating speed ratio, between main axis and subordinate axis.
- (3) There is no rule about size of the speed ratio between main/sub axis. If the speed ratio of main axis is bigger than sub's, the main axis will move faster than sub axis. If the speed ratio of sub axis is bigger than main's, the sub axis moves faster than main.
- (4) You can set axis to command in "AXIS" and the following value is available. If you set other values, error code "6" appears. XBF-PN04B:1~4, XBF-PN08B:1~8
- (5) You may set the main axis on MST_AXIS with following values. If you set wrongly, "Error 11" arises. XBF-PN04B:1~4, XBF-PN08B:1~8, 9 : Encoder1
- (6) The operating direction of subordinate depends on speed synchronization ratio ($\frac{Sub}{Main}$). If it is positive, operate in direction of main axis. If it is negative, operate in reverse direction of main axis.

7.7.3 Position Assigned Speed Synchronization (XPM_SSSP)

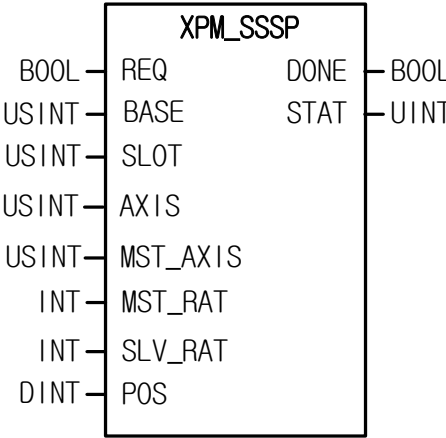
Form of Function Block	Description
 <p>The diagram shows a central box labeled 'XPM_SSSP'. On the left side, there are inputs: a BOOL input labeled 'REQ', two USINT inputs labeled 'BASE' and 'SLOT', two USINT inputs labeled 'AXIS' and 'MST_AXIS', an INT input labeled 'MST_RAT', an INT input labeled 'SLV_RAT', and a DINT input labeled 'POS'. On the right side, there are outputs: a BOOL output labeled 'DONE' and a UINT output labeled 'STAT'.</p>	<p>Input</p> <p>REQ : Request for execution of function block BASE : Set the base no. with module SLOT : Set the slot no. with module AXIS : Axis to command XBF-PN04B:1~4, XBF-PN08B:1~8 MST_AXIS : Set main axis XBF-PN04B:1~4, XBF-PN08B:1~8, 9: Encoder1 MST_RAT : Set speed rate of main axis -32,768 ~ 32,767 SLV_RAT : Set speed rate of sub axis -32,768 ~ 32,767 POS : Goal position -2,147,483,648 ~ 2,147,483,647</p> <p>Output</p> <p>DONE : Maintain 1 after first operating STAT : Output the error no. in operation</p>

- (1) Give “Position Assigned Speed Synchronization” command to the axis designated as the axis of positioning module with BASE (Base no. of Positioning module) and SLOT (Slot no. of Positioning module).
- (2) This command is for operating at the operation speed ratio between main axis and subordinate axis. It stops operating when the position of sub axis come to the position set on POS.
- (3) There is no rule about size of the speed ratio between main/sub axis. If the speed ratio of main axis is bigger than sub’s, the main axis will move faster than sub. If the speed ratio of sub axis is bigger than main’s, the sub axis moves faster than main.
- (4) You can set axis to command in “AXIS” and the following value is available. If you set other values, error code “6” appears.
XBF-PN04B:1~4, XBF-PN08B:1~8
- (5) You may set the main axis on MST_AXIS with following values. If you set wrongly, “Error6” arises.
XBF-PN04B:1~4, XBF-PN08B:1~8, 9 : Encoder1
- (6) The operating direction of subordinate depends on speed synchronization ratio ($\frac{Sub}{Main}$). If it is positive, operate in direction of main axis. If it is negative, operate in reverse direction of main axis.

7.7.4 CAM Operation (XPM_CAM)

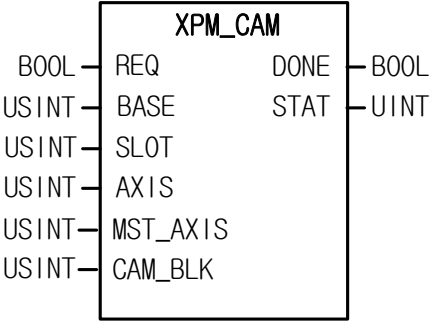
Form of Function Block	Description
	<p>Input</p> <p>REQ : Request for execution of function block BASE : Set the base no. with module SLOT : Set the slot no. with module AXIS : Axis to command XBF-PN04B:1~4, XBF-PN08B:1~8 MST_AXIS : Set main axis XBF-PN04B:1~4, XBF-PN08B:1~8, 9: Encoder1, CAM_BLK : Set CAM block 1 ~ 9: Block1 ~ Block9</p> <p>Output</p> <p>DONE : Maintain 1 after first operating STAT : Output the error no. in operation</p>

- (1) Give "CAM Operation" command to the axis designated as the axis of positioning module with BASE (Base no. of Positioning module) and SLOT (Slot no. of Positioning module).
- (2) Execute CAM operation with CAM main axis and CAM data block.
- (3) When executing CAM operation, sub axis is indicated that it is in operation but it does not work actually. When main axis starts, the motor starts working according to the data value of CAM data block which already set on CAM block (CAM_BLK)
- (4) You can set axis to command in "AXIS" and the following value is available. If you set other values, error code "6" appears.
 XBF-PN04B:1~4, XBF-PN08B:1~8
- (5) Set main axis of CAM operation at MST_AXIS and available value is as follows. In case other values are set, "Error 11" occurs.
 XBF-PN04B:1~4, XBF-PN08B:1~8, 9: Encoder1
- (6) Set CAM block number in CAM_BLK and available value is as follows. In case other values are set, "Error 11" occurs.
 1 ~ 9 : block1 ~ block9
- (7) CAM data may be set on positioning package and you may set max. 8 blocks (block1~block8).
- (8) In order to use user CAM operation, you have to set CAM block number as 9.
- (9) For detailed information on user CAM operation, refer to "94.4. user CAM operation".

7.7.5 Main Axis Offset-specified CAM Operation (XPM_CAMO)

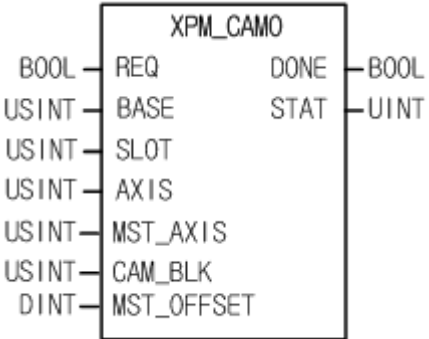
Form of Function Block	Description
	<p>Input</p> <p>REQ : Request for execution of function block BASE : Set the base no. with module SLOT : Set the slot no. with module AXIS : Axis to command XBF-PN04B:1~4, XBF-PN08B:1~8 MST_AXIS : Set main axis XBF-PN04B:1~4, XBF-PN08B:1~8, 9: Encoder1 CAM_BLK : Set CAM block 1 ~ 9: Block1 ~ Block9 MST_OFFSET: main offset transfer amount setting -2147483648 ~ 2147483647</p> <p>Output</p> <p>DONE : Maintain 1 after first operating STAT : Output the error no. in operation</p>

- (1) Give "Main Axis Offset-specified CAM Operation" command to the axis designated as the axis of positioning module with BASE (Base no. of Positioning module) and SLOT (Slot no. of Positioning module).
- (2) Execute CAM operation with CAM main axis and CAM data block.
- (3) When executing CAM operation, sub axis is indicated that it is in operation but it does not work actually. If main axis starts and moves as far as transfer amount set in the MST OFFSET, the motor starts working according to the data value of CAM data block which already set on CAM block (CAM_BLK)
- (4) You can set axis to command in "AXIS" and the following value is available. If you set other values, error code "6" appears.XBF-PN04B:1~4, XBF-PN08B:1~8
- (5) Set main axis of CAM operation at MST_AXIS and available value is as follows. In case other values are set, "Error 11" occurs.
XBF-PN04B:1~4, XBF-PN08B:1~8, 9: Encoder1
- (6) Set CAM block number in CAM_BLK and available value is as follows. In case other values are set, "Error 11" occurs.1 ~ 9 : block1 ~ block9
- (7) CAM data may be set on positioning package and you may set max. 8 blocks (block1~block8).
- (8) In order to use user CAM operation, you have to set CAM block number as 9.
- (9) For detailed information on user CAM operation, refer to "94.4. user CAM operation".

7.7.6 Torque synchronous (XPM_XSTC)

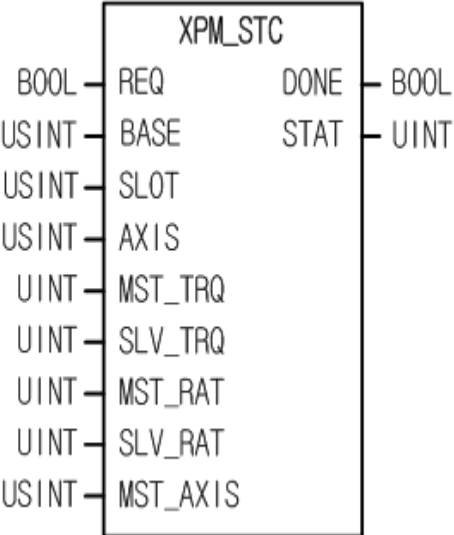
Form of Function Block	Description
 <p>The diagram shows a rectangular function block labeled 'XPM_XSTC'. On the left side, there are eight input ports: a Boolean input 'REQ', and seven unsigned integer inputs 'BASE', 'SLOT', 'AXIS', 'MST_TRQ', 'SLV_TRQ', 'MST_RAT', and 'SLV_RAT'. On the right side, there are two output ports: a Boolean output 'DONE' and an unsigned integer output 'STAT'.</p>	<p>Input</p> <ul style="list-style-type: none"> REQ : Request for execution of function block BASE : Set the base no. with module SLOT : Set the slot no. with module AXIS : Axis to command XBF-PN04B:1~4, XBF-PN08B:1~8 MST_TRQ : Set torque ratio of main axis 1~65535 SLV_TRQ : Set torque ratio of sub axis 1~65535 MST_RAT : Set speed ratio of main axis 1~65535 SLV_RAT : Set speed ratio of sub axis Unused MST_AXIS : Set main axis of torque synchronous Unused <p>Output</p> <ul style="list-style-type: none"> DONE : Maintain 1 after first operating STAT : Output the error no. in operation

- (1) This function block is used to execute the torque synchronous at relevant axis of servo drive connected to positioning module.
 - (2) Give “Main Axis Offset-specified CAM Operation” command to the axis designated as the axis of positioning module with BASE (Base no. of Positioning module) and SLOT (Slot no. of Positioning module).
 - (3) The axis to perform command execute torque synchronous by axis(MST_AXIS) as main axis.
 - (4) The axis to perform command execute torque synchronous by torque ratio(MST_TRQ, SLV_TRQ) and speed ratio(MST_RAT, SLV_RAT).
- Sub axis torque = (SLV_TRQ/MST_TRQ) * Main axis torque
 Torque synchronous speed of sub axis = (SLV_RAT/MST_RAT) * Speed of main axis
- (5) You can set axis to command in “AXIS” and the following value is available. If you set other values, error code “6” appears. XBF-PN04B:1~4, XBF-PN08B:1~8
 - (6) Set main axis of torque synchronous at MST_AXIS and available value is as follows. In case other values are set, “Error 11” occurs. XBF-PN04B:1~4, XBF-PN08B:1~8

7.7.7 Phase Correction (XPM_PHASING)

Form of Function Block	Description
<div style="text-align: center; border: 1px solid black; padding: 5px; width: fit-content; margin: 0 auto;"> XPM_PHASING </div> <pre> graph LR REQ[REQ] --- XPM_PHASING BASE[BASE] --- XPM_PHASING SLOT[SLOT] --- XPM_PHASING AXIS[AXIS] --- XPM_PHASING MST_AXIS[MST_AXIS] --- XPM_PHASING PHASE_VAL[PHASE_VAL] --- XPM_PHASING VELOCITY[VELOCITY] --- XPM_PHASING ACC_TIME[ACC_TIME] --- XPM_PHASING DEC_TIME[DEC_TIME] --- XPM_PHASING XPM_PHASING --- DONE[DONE] XPM_PHASING --- STAT[STAT] </pre> <p> BOOL — REQ DONE — BOOL USINT — BASE STAT — UINT USINT — SLOT USINT — AXIS USINT — MST_AXIS DINT — PHASE_VAL UDINT — VELOCITY UDINT — ACC_TIME UDINT — DEC_TIME </p>	<p>Input</p> <p> REQ : Request for execution of function block BASE : Set the base no. with module SLOT : Set the slot no. with module AXIS : Axis to command MST_AXIS : Set main axis of phase correction 1~8: axis 9: Encoder1, 10: Encoder2 PHASE_VAL : Phase correction value VELOCITY : Speed of phase correction ACC_TIME : Acceleration time (0 ~ 2,147,483,647 ms) DEC_TIME : Deceleration time (0 ~ 2,147,483,647 ms) </p> <p>Output</p> <p> DONE : Maintain 1 after first operating STAT : Output the error no. in operation </p>

- (1) This function block enables the synchronous operation on the position of main-axis with the corrected sub-axis by executing the phase correction with respect to the reference position of the main-axis of the axis specified as AXIS of the positioning module.
- (2) Phase correction is executed with values set in VELOCITY, ACC_TIME, DEC_TIME as much as the amount of phase correction set in PHAS-VAL with respect to the main-axis set in MST_AXIS of the axis specified as AXIS of the positioning module designated as BASE(base number of the positioning module) and SLOT(slot number of the positioning module).
- (3) In AXIS, axesto issue commands are set, and the following values can be set. If the value other than setting values is set, "Error6" occurs.
 - 1) XBF-PN08B
1 ~ 8 : 1 Axis ~ 8 Axis
 - 2) XBF-PN04B
1 ~ 4 : 1 Axis ~ 4 Axis
- (4) In MST_AXIS, the main-axis of phase correction command is set, and the following values can be set. If the value other than setting values is set, "Error11" occurs.
 - 1) XBF-PN08B
1 ~ 8 : 1 Axis ~ 8 Axis, 9:Encoder1, 10:Encoder2
 - 2) XBF-PN04B
2 ~ 4 : 1 Axis ~ 4 Axis, 9:Encoder1, 10:Encoder2

7.7.8 32Bit Rate Synchronization (XPM_SSSD)

Form of Function Block	Description
	<p>Input</p> <p>REQ : Request for execution of function block BASE : Set the base no. with module SLOT : Set the slot no. with module AXIS : Axis to command</p> <p>MST_AXIS : Set main axis of phase correction 1~8: axis 9: Encoder1, 10: Encoder2 MST_RAT: Speed ratio of the main-axis (-2,147,483,648 ~ 2,147,483,647) SLV_RAT : Speed ratio of the sub-axis (-2,147,483,648 ~ 2,147,483,647)</p> <p>Output</p> <p>DONE : Maintain 1 after first operating STAT : Output the error no. in operation</p>

- (1) Speed synchronization command is issued to the axis specified as AXIS of the positioning module designated as BASE (base number of the positioning module) and SLOT (slot number of the positioning module).
- (2) It is used to control with the ratio to set the operation speed between the two axes. The values of main-axis ratio and sub-axis ratio can be set in 32-bit integer range.
- (3) There are no rules on the size between the speed ratio of the main-axis and that of the sub-axis. That is, if the speed ratio of the main-axis is greater than that of the sub-axis, the main-axis is faster than the sub-axis, and if the speed ratio of the sub-axis is greater than that of the main-axis, the sub-axis is faster than the main-axis.
- (4) In AXIS, axes to issue commands are set, and the following values can be set. If the value other than setting values is set, "Error6" occurs.
 XBF-PN04B: 1 ~ 4(1 axis - 4 axis), XBF-PN08B: 1 ~ 8(1 axis - 8 axis)
- (5) In MST_AXIS, the main-axis of the speed synchronization is set, and the following values can be set. If the value other than setting values is set, "Error11" occurs.
 XBF-PN04B: 1 ~ 4(1 axis- 4 axis), XBF-PN08B: 1 ~ 8(1 axis- 8 axis), 9: Encoder 1, 10: Encoder 2
- (6) The sub-axis is operated in the operational direction of the main-axis if the speed synchronization ratio (main-axis ratio / sub-axis ratio) is positive, and in the opposite direction of the main-axis if it is negative.

7.7.9 32 Bit Positioning Speed Synchronization (XPM_SSSPD)

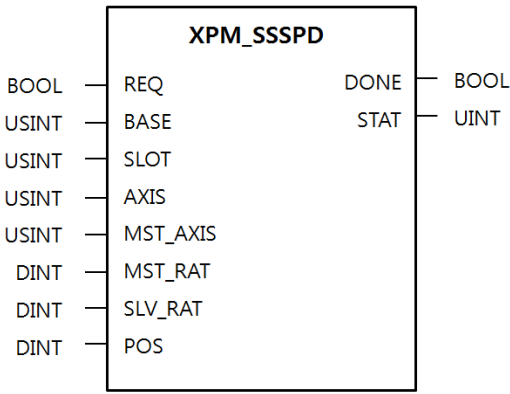
Form of Function Block	Description
<div style="text-align: center; border: 1px solid black; padding: 5px; width: fit-content; margin: 0 auto;"> XPM_SSSPD </div>  <pre> graph LR REQ[REQ] --- XPM_SSSPD BASE[BASE] --- XPM_SSSPD SLOT[SLOT] --- XPM_SSSPD AXIS[AXIS] --- XPM_SSSPD MST_AXIS[MST_AXIS] --- XPM_SSSPD MST_RAT[MST_RAT] --- XPM_SSSPD SLV_RAT[SLV_RAT] --- XPM_SSSPD POS[POS] --- XPM_SSSPD XPM_SSSPD --- DONE[DONE] XPM_SSSPD --- STAT[STAT] </pre>	<p>Input</p> <p>REQ : Request for execution of function block BASE : Set the base no. with module SLOT : Set the slot no. with module AXIS : Axis to command 1~4: XBF-PN04B, 1~8: XBF-PN08B MST_AXIS : Set main axis of phase correction 1~8: axis 9: Encoder1, 10: Encoder2 MST_RAT: Speed ratio of the main-axis (-2,147,483,648 ~ 2,147,483,647) SLV_RAT : Speed ratio of the sub-axis (-2,147,483,648 ~ 2,147,483,647) POS : Target position.</p> <p>Output</p> <p>DONE : Maintain 1 after first operating STAT : Output the error no. in operation</p>

- (1) Positioning speed synchronization command is issued to the axis specified as AXIS of the positioning module designated as BASE (base number of the positioning module) and SLOT (slot number of the positioning module).
- (2) It is used to control with the ratio to set the operation speed between the two axes. The values of main-axis ratio and sub-axis ratio can be set in 32-bit integer range. After the execution of XPM_SSSPD, when the position to which the sub-axis is moved becomes the one specified in POS, the speed synchronization ends and stops.
- (3) There are no rules on the size between the speed ratio of the main-axis and that of the sub-axis. That is, if the speed ratio of the main-axis is greater than that of the sub-axis, the main-axis is faster than the sub-axis, and if the speed ratio of the sub-axis is greater than that of the main-axis, the sub-axis is faster than the main-axis.
- (3) In AXIS, axes to issue commands are set, and the following values can be set. If the value other than setting values is set, "Error6" occurs.
XBF-PN04B: 1 ~ 4(1 axis - 4 axis), XBF-PN08B: 1 ~ 8(1 axis - 8 axis)
- (5) In MST_AXIS, the main-axis of the speed synchronization is set, and the following values can be set. If the value other than setting values is set, "Error11" occurs.
XBF-PN04B: 1 ~ 4(1 axis- 4 axis), XBF-PN08B: 1 ~ 8(1 axis- 8 axis), 9: Encoder 1, 10: Encoder 2
- (6) The sub-axis is operated in the operational direction of the main-axis if the speed synchronization ratio (main-axis ratio / sub-axis ratio) is positive, and in the opposite direction of the main-axis if it is negative.

7.7.10 Absolute positioning CAM operation (XPM_CAMA)

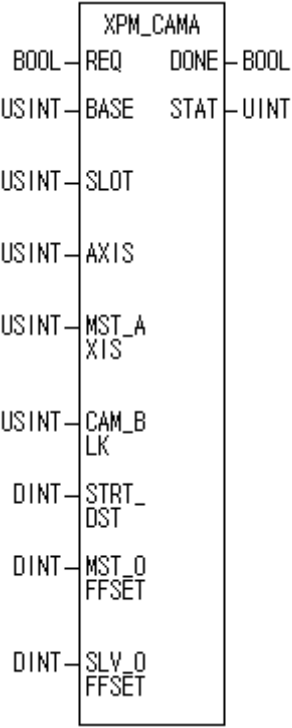
Form of Function Block Description	Form of Function Block Description
 <p>The diagram shows a rectangular function block labeled 'XPM_CAMA'. On the left side, there are several input terminals: 'REQ' (BOOL), 'BASE' (USINT), 'SLOT' (USINT), 'AXIS' (USINT), 'MST_AXIS' (USINT), 'CAM_BLK' (USINT), 'STRT_DST' (DINT), 'MST_OFFSET' (DINT), and 'SLV_OFFSET' (DINT). On the right side, there are two output terminals: 'DONE' (BOOL) and 'STAT' (UINT).</p>	<p>INPUT</p> <p>REQ : Request for execution</p> <p>BASE : Set the base no. with module</p> <p>SLOT : Set the slot no. with module</p> <p>AXIS : Axis to command XBF-PN04B:1~4, XBF-PN08B:1~8 9:Encoder: 1</p> <p>CAM_BLK : Set the CAM block 1block~ 9block</p> <p>STRT_DST : CAM start movement setting -2147483648 ~ 2147483647</p> <p>MST_OFFSET : Main-axis offset setting -2147483648 ~ 2147483647</p> <p>SLV_OFFSET : Sub-axis offset setting -2147483648 ~ 2147483647</p> <p>OUTPUT</p> <p>DONE : Maintain 1 after first operating</p> <p>STAT : Output the error no. in operation</p>

- (1) Command to absolute positioning CAM operation at the axis of the designated module of BASE(Base number of positioning module) and SLOT(Slot number of positioning module)
- (2) Operate the CAM by using the CAM main axis, CAM data block, CAM operating start position, main-axis offset, sub-axis offset of the axis.
- (3) Operating absolute CAM command and if the axis set as the main axis starts, it executes the operation to reach synchronous position until it moves by the distance set in STRT_DST. The synchronized position can be moved according to the setting of the MST_OFFSET and SLV_OFFSET values to the position on the subordinate axis according to the CAM data value set in the cam block (CAM_BLK) when the main axis is in STRT_DST. When the main axis reaches the distance set in STRT_DST, the motor starts to move to the subordinate axis position corresponding to the main axis position according to the data value of the cam data block set in the cam block (CAM_BLK).

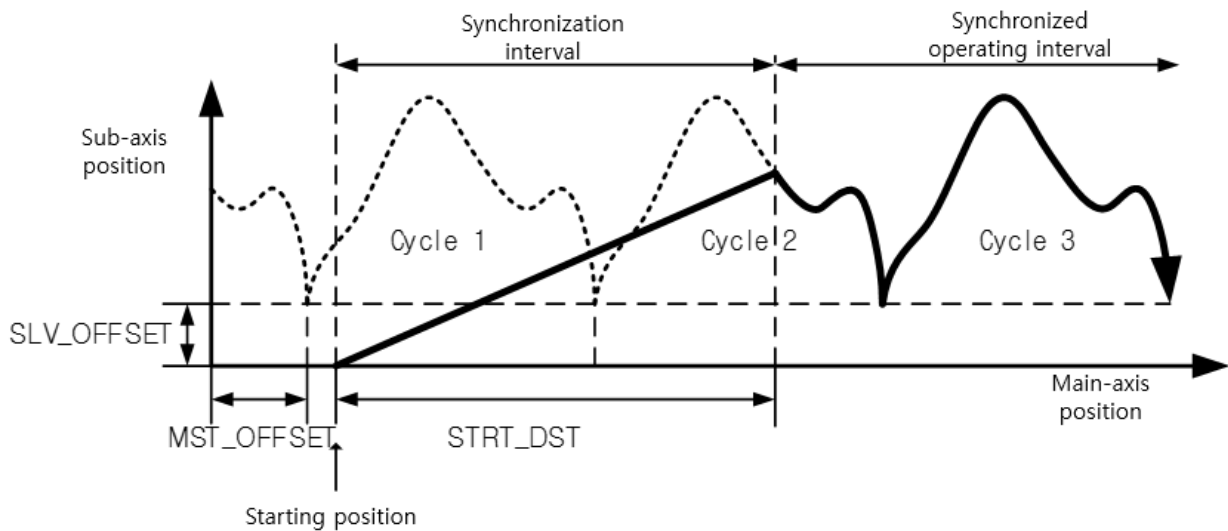

- (4) You can set the following values for the axis by configure command axis.
 If a value except the set value is set, "Error 6" occurs.
 XBF-PN04B: 1~4 (axis-1~ axis 4), XBF-PN08B: 1 ~ 8(axis 1 ~ axis 8)
- (5) Set the main-axis of CAM operation at MST_AXIS, and the following values can be set.
 If a value except the set value is set, "Error 11" occurs.
 XBF-PN04B: 1~4 (axis-1~ axis 4), XBF-PN08B: 1 ~ 8(axis 1 ~ axis 8), 9: Encoder
- (6) Set the CAM block number to be executed at CAM_BLK, and the following values can be set.
 If a value except the set value is set, "Error 11" occurs.
 1 ~ 9: Block 1 ~ 9
- (7) The cam data can be created in the positioning package, and you can set up to 8 blocks
 (Block 1 to block 8).
- (8) To use the absolute positioning CAM operation, set the cam block number to 9
- (9) Refer to "9.4.6 Absolute positioning CAM operation" for details on user CAM operation.

7.7.11 Synchronous speed designating synchronous position (XPM_GEARIP)

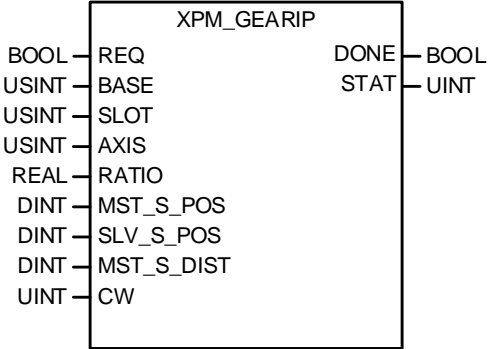
Function Block type	Content
 <p>The diagram shows a rectangular function block labeled 'XPM_GEARIP'. On the left side, there are input terminals: a Boolean terminal 'REQ', two USINT terminals 'BASE' and 'SLOT', two USINT terminals 'AXIS', a REAL terminal 'RATIO', two DINT terminals 'MST_S_POS' and 'SLV_S_POS', a DINT terminal 'MST_S_DIST', and a UINT terminal 'CW'. On the right side, there are output terminals: a Boolean terminal 'DONE' and a UINT terminal 'STAT'.</p>	<p>Input</p> <p>REQ: Request the execution of function blocks BASE: Set the number of a base equipped with a module SLOT: Set the number of a slot equipped with a module AXIS: Designate the axis of command execution XBF-PN04B: 1-4 (Axis 1-Axis 4) XBF-PN08B: 1-8 (Axis 1-Axis 8) RATIO: Set the synchronization rate MST_S_POS: Set a position of the main axis to be synchronized SLV_S_POS: Set a position for the minor axis to be synchronized MST_S_DIST: Distance of the major axis to start synchronous rotation CW: Main Axis</p> <p>Output</p> <p>DONE: Maintain 1 after initial operation STAT: Output an error code that occurred during the execution of function blocks</p>

- (1) The speed synchronization command is given to the AXIS of a positioning module designated by BASE (the base number of a positioning module) and SLOT (the slot number of a positioning module).
- (2) It is used when controlling the operating speed between two axes by the set rate.
- (3) When the speed ratio of the major axis is greater than that of the minor axis, the major axis moves faster than the minor axis. When the speed ratio of the minor axis is greater than that of the major axis, the minor axis moves faster than the major axis.
- (4) The axis of command execution is set to AXIS and the following values can be set to it: When setting values other than the setting value, "Error Code 6" occurs.
 XBF-PN04B: 1-4 (Axis 1-Axis 4), XBF-PN08B: 1-8 (Axis 1-Axis 8)
- (5) The synchronous speed designating synchronous position is set to CW and the following values can be set to it: XBF-PN04B: 1-4 (Axis 1-Axis 4), XBF-PN08B: 1-8 (Axis 1-Axis 8), 9: Encoder 1, 10: Encoder 2
- (6) If the synchronization rate is positive, the minor axis rotates in the direction of the major axis. If it is negative, it rotates in the opposite direction of the major axis.
- (7) Supported versions of the Function Block are as follows:
 - XBF-PN04B, XBF-PN08B OS: V1.80 or higher
 - XGI OS: V4.10 or higher, XGI OS(high performance): V1.30 or higher
 - XG5000: V4.28 or higher

7.8 Modification Function Block

7.8.1 Position Override (XPM_POR)

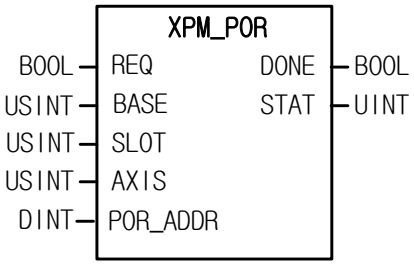
Form of Function Block	Description
	<p>Input</p> <p>REQ : Request for execution of function block BASE : Set the base no. with module SLOT : Set the slot no. with module AXIS : Axis to command XBF-PN04B:1~4, XBF-PN08B:1~8 POR_ADDR : Set a new goal position -2,147,483,648 ~ 2,147,483,647</p> <p>Output</p> <p>DONE : Maintain 1 after first operating STAT : Output the error no. in operation</p>

- (1) Give "Position Override" command to the axis designated as the axis of positioning module with BASE (Base no. of Positioning module) and SLOT (Slot no. of Positioning module).
- (2) This command is for changing the goal position in operation.
- (3) If execute position override after pass the position to execute position override, it will stop at the current position and turn back to the position set on POR_ADDR.
- (4) Set the goal position to modify on POR_ADDR.'
- (5) Override position set on position override is absolute coordinates.
- (6) You can set axis to command in "AXIS" and the following value is available. If you set other values, error code "6" appears.

XBF-PN04B:1~4, XBF-PN08B:1~8

7.8.2 Speed Override (XPM_SOR)

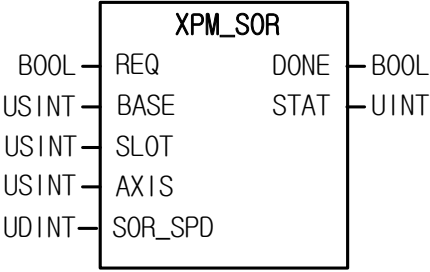
Form of Function Block	Description
	<p>Input</p> <p>REQ : Request for execution of function block BASE : Set the base no. with module SLOT : Set the slot no. with module AXIS : Axis to command XBF-PN04B:1~4, XBF-PN08B:1~8 SOR_SPD : Set a new operation speed value</p> <p>Output</p> <p>DONE : Maintain 1 after first operating STAT : Output the error no. in operation</p>

- (1) Give “Speed Override” command to the axis designated as the axis of positioning module with BASE (Base no. of Positioning module) and SLOT (Slot no. of Positioning module).
- (2) This command is for changing the operating speed in operation.
- (3) It may be set to “%” or “Speed value (unit/time)” according to “Speed Override” value of common parameter.
- (4) If unit of Speed override is %, setting range is from 1 to 65,535. It means 0.01% ~ 655.35%.
- (5) If unit of speed override is speed value, the setting range is from 1 to speed limit. The speed limit is the value set on “Speed Limit” item of basic parameter and the unit of speed override is the same as unit of axis.
- (6) You can set axis to command in “AXIS” and the following value is available. If you set other values, error code “6” appears.
 XBF-PN04B:1~4, XBF-PN08B:1~8

7.8.3 Position Assigned Speed Override (XPM_PSO)

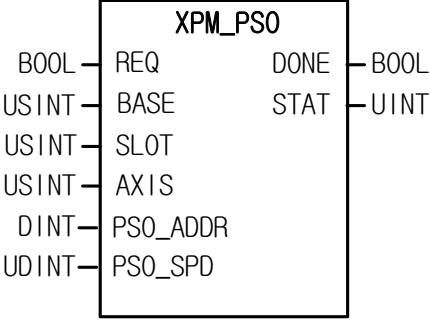
Form of Function Block	Description
	<p>Input</p> <p>REQ : Request for execution of function block BASE : Set the base no. with module SLOT : Set the slot no. with module AXIS : Axis to command XBF-PN04B:1~4, XBF-PN08B:1~8 PSO_ADDR : The position to change speed -2,147,483,648 ~ 2,147,483,647 PSO_SPD : Set new speed value</p> <p>Output</p> <p>DONE : Maintain 1 after first operating STAT : Output the error no. in operation</p>

- (1) Give "Position Assigned Speed Override" command to the axis designated as the axis of positioning module with BASE (Base no. of Positioning module) and SLOT (Slot no. of Positioning module).
- (2) This command is for changing operating speed in operation after command axis arrive at definite position.
- (3) The speed value set on PSO_SPD will be "% Designation" or "Speed value Designation" depending on the value set on "Speed Override" of common parameter.
- (4) If unit of speed value is %, the setting range is from 1 ~ 65,535 and it means 0.01% ~ 655.35%.
- (5) You can set axis to command in "AXIS" and the following value is available. If you set other values, error code "6" appears.
XBF-PN04B:1~4, XBF-PN08B:1~8

7.8.4 Position/Speed Switching Control (XPM_PTV)

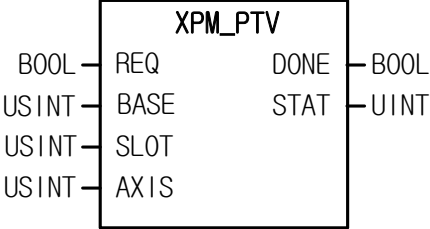
Form of Function Block	Description
	<p>Input</p> <p>REQ : Request for execution of function block BASE : Set the base no. with module SLOT : Set the slot no. with module AXIS : Axis to command XBF-PN04B:1~4, XBF-PN08B:1~8</p> <p>Output</p> <p>DONE : Maintain 1 after first operating STAT : Output the error no. in operation</p>

- (1) Give "Position/Speed Switching Control" command to the axis designated as the axis of positioning module with BASE (Base no. of Positioning module) and SLOT (Slot no. of Positioning module).
- (2) When the designated axis is in positioning control operation, if it receives position/speed control switching command, positioning control operation will be changed into speed control operation and continues to operate until stop command.
- (3) Once the command is executed, origin would not be assigned and then operate in speed control.
- (4) You can set axis to command in "AXIS" and the following value is available. If you set other values, error code "6" appears.
 XBF-PN04B:1~4, XBF-PN08B:1~8

7.8.5 Speed/Position Switching Control (XPM_VTP)

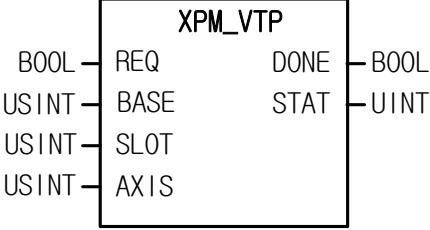
Form of Function Block	Description
	<p>Input</p> <p>REQ : Request for execution of function block BASE : Set the base no. with module SLOT : Set the slot no. with module AXIS : Axis to command XBF-PN04B:1~4, XBF-PN08B:1~8</p> <p>Output</p> <p>DONE : Maintain 1 after first operating STAT : Output the error no. in operation</p>

- (1) Give “Speed/Position Switching Control” command to the axis designated as the axis of positioning module with BASE (Base no. of Positioning module) and SLOT (Slot no. of Positioning module).
- (2) When the designated axis receives speed/position control switching command in speed control operation, speed control will be changed to position control and keep operating by the position value at the beginning.
- (3) You can set axis to command in “AXIS” and the following value is available. If you set other values, error code “6” appears.
XBF-PN04B:1~4, XBF-PN08B:1~8

7.8.6 Position-specified Speed/Position Switching Control (XPM_VTPP)

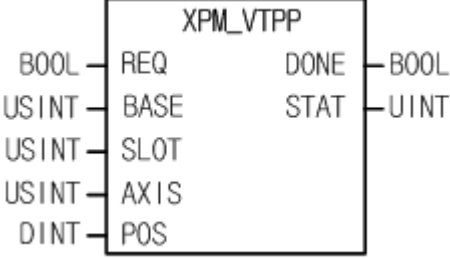
Form of Function Block	Description
	<p>Input</p> <p>REQ : Request for execution of function block BASE : Set the base no. with module SLOT : Set the slot no. with module AXIS : Axis to command XBF-PN04B:1~4, XBF-PN08B:1~8 POS: transfer amount -2,147,483,648 ~ 2,147,483,647</p> <p>Output</p> <p>DONE : Maintain 1 after first operating STAT : Output the error no. in operation</p>

- (1) Give "Position-specified Speed/Position Switching Control" command to the axis designated as the axis of positioning module with BASE (Base no. of Positioning module) and SLOT (Slot no. of Positioning module).
- (2) When the designated axis receives speed/position control switching command in speed control operation, speed control will be changed to position control and moves by transfer amount set in POS.
- (3) You can set axis to command in "AXIS" and the following value is available. If you set other values, error code "6" appears. XBF-PN04B:1~4, XBF-PN08B:1~8

7.8.7 Position/Torque Switching Control (XPM_PTT)

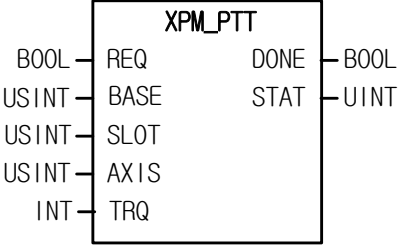
Form of Function Block	Description
	<p>Input</p> <p>REQ : Request for execution of function block BASE : Set the base no. with module SLOT : Set the slot no. with module AXIS : Axis to command XBF-PN04B:1~4, XBF-PN08B:1~8 TRQ: torque value</p> <p>Output</p> <p>DONE : Maintain 1 after first operating STAT : Output the error no. in operation</p>

- (1) Give "Position/Torque Switching Control" command to the axis designated as the axis of positioning module with BASE (Base no. of Positioning module) and SLOT (Slot no. of Positioning module).
- (2) When the designated axis receives position/torque switching control command in position control operation, position control will be changed to torque control and keep moving until stop command.
- (3) The range of Torque value is -32768~32767 and unit is [%]. The allowable range of torque value may vary according to the connected servo drive. In general, target torque value is limited to the maximum torque setting.
- (4) You can set axis to command in "AXIS" and the following value is available. If you set other values, error code "6" appears.
XBF-PN04B:1~4, XBF-PN08B:1~8

7.8.8 Skip Operation (XPM_SKP)

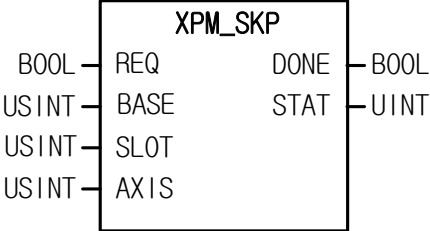
Form of Function Block	Description
	<p>Input</p> <p>REQ : Request for execution of function block BASE : Set the base no. with module SLOT : Set the slot no. with module AXIS : Axis to command XBF-PN04B:1~4, XBF-PN08B:1~8</p> <p>Output</p> <p>DONE : Maintain 1 after first operating STAT : Output the error no. in operation</p>

- (1) Give "Skip Operation" command to the axis designated as the axis of positioning module with BASE (Base no. of Positioning module) and SLOT (Slot no. of Positioning module).
- (2) This command is for operating the next step. That is, stop operating of the current step and then start operating the next step.
- (3) Skip a step at once.
- (4) You can set axis to command in "AXIS" and the following value is available. If you set other values, error code "6" appears.
 XBF-PN04B:1~4, XBF-PN08B:1~8

7.8.9 Continuous Operation (XPM_NMV)

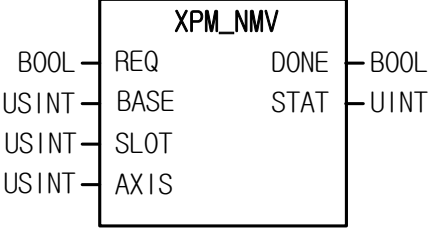
Form of Function Block	Description
	<p>Input</p> <p>REQ : Request for execution of function block BASE : Set the base no. with module SLOT : Set the slot no. with module AXIS : Axis to command XBF-PN04B:1~4, XBF-PN08B:1~8</p> <p>Output</p> <p>DONE : Maintain 1 after first operating STAT : Output the error no. in operation</p>

- (1) Give "Continuous Operation" command to the axis designated as the axis of positioning module with BASE (Base no. of Positioning module) and SLOT (Slot no. of Positioning module).
- (2) This command is for command axis to continue to operate the next step without stop.
- (3) If this command is executed, the current step no. would be changed to the next step no. and continue to execute positioning operation at the next step speed to the goal position.
- (4) Continuous Operation command only changes the current operation pattern, not changes operation data.
- (5) You can set axis to command in "AXIS" and the following value is available. If you set other values, error code "6" appears. XBF-PN04B:1~4, XBF-PN08B:1~8

7.8.10 Start Step Number Change (XPM_SNS)

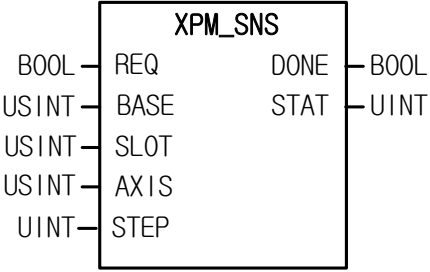
Form of Function Block	Description
	<p>Input</p> <p>REQ : Request for execution of function block BASE : Set the base no. with module SLOT : Set the slot no. with module AXIS : Axis to command XBF-PN04B:1~4, XBF-PN08B:1~8 STEP : Set the operation step no. to operate 1 ~ 400</p> <p>Output</p> <p>DONE : Maintain 1 after first operating STAT : Output the error no. in operation</p>

- (1) Give "Start Step no. Change" command to the axis designated as the axis of positioning module with BASE (Base no. of Positioning module) and SLOT (Slot no. of Positioning module).
- (2) This command is for changing the operation step of command axis.
- (3) You can set axis to command in "AXIS" and the following value is available. If you set other values, error code "6" appears.
 XBF-PN04B:1~4, XBF-PN08B:1~8
- (4) Set the step no. on STEP. The setting range is 1 ~ 400, if you set the setting value wrongly, "Error11" arises.

7.8.11 Repeat Step No. Change (XPM_SRS)

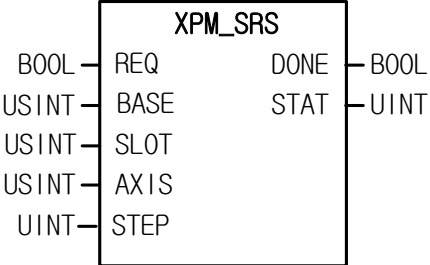
Form of Function Block	Description
	<p>Input</p> <p>REQ : Request for execution of function block BASE : Set the base no. with module SLOT : Set the slot no. with module AXIS : Axis to command XBF-PN04B:1~4, XBF-PN08B:1~8</p> <p>STEP : Set the repeat step no. to change 1 ~ 400</p> <p>Output</p> <p>DONE : Maintain 1 after first operating STAT : Output the error no. in operation</p>

- (1) Give "Repeat Step no. Change" command to the axis designated as the axis of positioning module with BASE (Base no. of Positioning module) and SLOT (Slot no. of Positioning module).
- (2) This command is for designating the starting step no. of repeat operation and operating from the designated operation step.
- (3) You can set axis to command in "AXIS" and the following value is available. If you set other values, error code "6" appears.
XBF-PN04B:1~4, XBF-PN08B:1~8
- (4) Set the step no. to operate repeatedly on STEP. The setting range is 1 ~ 400, if you set the setting value wrongly, "Error11" arises.

7.8.12 Current Position Change (XPM_PRS)

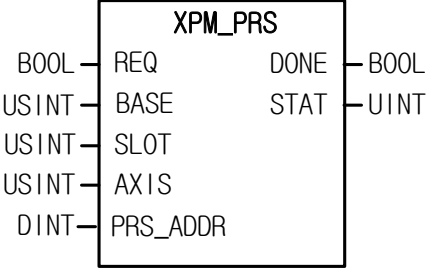
Form of Function Block	Description
	<p>Input</p> <p>REQ : Request for execution of function block BASE : Set the base no. with module SLOT : Set the slot no. with module AXIS : Axis to command XBF-PN04B:1~4, XBF-PN08B:1~8 PRS_ADDR : Set the current position value to change. -2,147,483,648 ~ 2,147,483,647</p> <p>Output</p> <p>DONE : Maintain 1 after first operating STAT : Output the error no. in operation</p>

- (1) Give “Basic Parameter Setting” command to the axis designated as the axis of positioning module with BASE (Base no. of Positioning module) and SLOT (Slot no. of Positioning module).
- (2) This command is for changing the current position to random position. If it is executed in the state of non-origin, the origin signal would be On and the current position would be set as setting value (PRS_ADDR).
- (3) You can set axis to command in “AXIS” and the following value is available. If you set other values, error code “6” appears.
 XBF-PN04B:1~4, XBF-PN08B:1~8

7.8.13 Encoder Value Preset (XPM_EPRES)

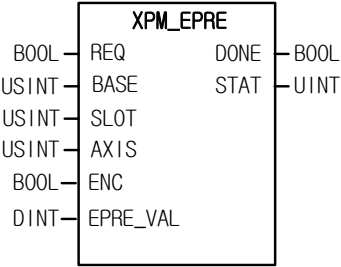
Form of Function Block	Description
	<p>Input</p> <p>REQ : Request for execution of function block BASE : Set the base no. with module SLOT : Set the slot no. with module AXIS : Axis to command XBF-PN04B:1~4, XBF-PN08B:1~8 ENC : Encoder no. 0: Encoder1 EPRES_VAL : Set the value of encoder preset -2147483648 ~ 2147483647</p> <p>Output</p> <p>DONE : Maintain 1 after first operating STAT : Output the error no. in operation</p>

- (1) Give “Encoder Preset” command to the axis designated as the axis of positioning module with BASE (Base no. of Positioning module) and SLOT (Slot no. of Positioning module).
- (2) This command is for changing the current value of encoder to the value set on EPRES_VAL
- (3) Set the encoder to preset on ENC.
- (4) You can set axis to command in “AXIS” and the following value is available. If you set other values, error code “6” appears.
XBF-PN04B:1~4, XBF-PN08B:1~8

7.8.14 Speed Acceleration/Deceleration override(XPM_SETOVR)

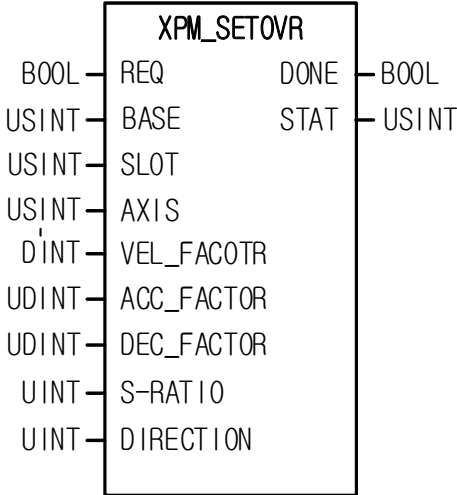
Form of Function Block	Description
 <p>The diagram shows a rectangular function block labeled 'XPM_SETOVR'. On the left side, there are inputs: a BOOL input for 'REQ', a USINT input for 'BASE', a USINT input for 'SLOT', a USINT input for 'AXIS', a DINT input for 'VEL_FACTOR', a UDINT input for 'ACC_FACTOR', a UDINT input for 'DEC_FACTOR', a UINT input for 'S-RATIO', and a UINT input for 'DIRECTION'. On the right side, there are outputs: a BOOL output for 'DONE' and a USINT output for 'STAT'.</p>	<p>Input</p> <p>REQ : Request for execution BASE : Set the base no. with module SLOT : Set the slot no. with module AXIS : Axis to command XBF-PN04B:1~4, XBF-PN08B:1~8</p> <p>VEL_FACTOR : Override ratio for speed (or Command speed) ACC_FACTOR : Override ratio for acceleration time (or Command acceleration time) DEC_FACTOR : Override ratio for deceleration time (or Command deceleration time) S_RATIO : Unused (S-curve ratio (0= Trapezoid, 1~100: S-curve ratio)) DIRECTION : Operating direction (1 ~ 3: 1-forward, 2-reverse, 3-current)</p> <p>Output</p> <p>DONE : Maintain 1 after first operating STAT : Output the error no. in operation</p>

- (1) Give "Acceleration/deceleration speed override" command to the axis designated as the axis of positioning module with BASE (Base no. of Positioning module) and SLOT (Slot no. of Positioning module).
- (2) This command is used when the command axis is in operation and you want to change operation speed, acceleration, deceleration, direction.
- (3) VEL_FACTOR, ACC_FACTOR, DEC_FACTOR is configurable in "speed override" of common parameters, it can be set "%" or "speed(unit/time)".
- (4) If the unit of the speed override is set the speed percent(%), it means ratio for acceleration time override ratio and configurable setting area is -65,535 ~ +65,535. It means actually -65.35% ~ 65.35%. If you set a negative value, it will operate in the opposite direction.
- (5) If the unit of the speed override is set the speed value, configurable setting area is -('speed limit' of 'operation parameter') ~ +('speed limit' of 'operation parameter'). The units of the speed override value follow the axis unit.
- (6) If the unit of the acceleration override is set the percent (%), it means ratio for acceleration time override ratio and configurable setting area is -65,535 ~ +65,535. It means actually -65.35% ~ 65.35%.
- (7) If the override value unit of acceleration/ deceleration is a speed value, configurable setting area is 0~4,294,967,295.
- (8) Operation direction is configurable only for 1(Forward), 2(Reverse), 3(Current)
- (9) You can set axis to command in "AXIS" and the following value is available. If you set other values, error code "6" appears. XBF-PN04B:1~4, XBF-PN08B:1~8

7.9 Error Function blocks

7.9.1 Error Reset (XPM_RST)

Form of Function Block	Description
	<p>Input</p> <p>REQ : Request for execution of function block BASE : Set the base no. with module SLOT : Set the slot no. with module AXIS : Axis to command XBF-PN04B:1~4, XBF-PN08B:1~8 SEL : Select axis error/common error 0:axis error 1: common error</p> <p>Output</p> <p>DONE : Maintain 1 after first operating STAT : Output the error no. in operation</p>

- (1) Give "Error Reset" command to the axis designated as the axis of positioning module with BASE (Base no. of Positioning module) and SLOT (Slot no. of Positioning module).
- (2) You can set axis to command in "AXIS" and the following value is available. If you set other values, error code "6" appears.
XBF-PN04B:1~4, XBF-PN08B:1~8
- (3) This is for resetting the errors.
- (4) Select the kind of error to reset on SEL. If SEL is set to 0, it will reset the errors of the designated axis. And if that is set to 1, it will reset the errors affecting entire module, not axis error.

7.9.2 Error History Reset (XPM_HRST)

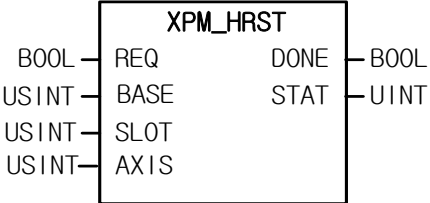
Form of Function Block	Description
	<p>Input</p> <p>REQ : Request for execution of function block BASE : Set the base no. with module SLOT : Set the slot no. with module AXIS : Axis to command XBF-PN04B:1~4, XBF-PN08B:1~8</p> <p>Output</p> <p>DONE : Maintain 1 after first operating STAT : Output the error no. in operation</p>

- (1) Give "Error History Reset" command to the axis designated as the axis of positioning module with BASE (Base no. of Positioning module) and SLOT (Slot no. of Positioning module).
- (2) You can set axis to command in "AXIS" and the following value is available. If you set other values, error code "6" appears.
 XBF-PN04B:1~4, XBF-PN08B:1~8
- (3) If errors arise, Max.10 errors are saved on module. This command is for resetting error history.

7.10 Other Function Blocks related with the Module

7.10.1 Floating Origin Setting (XPM_FLT)

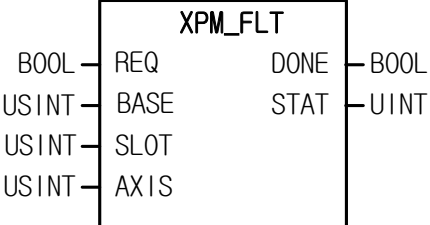
Form of Function Block	Description
	<p>Input</p> <p>REQ : Request for execution of function block BASE : Set the base no. with module SLOT : Set the slot no. with module AXIS : Axis to command XBF-PN04B:1~4, XBF-PN08B:1~8</p> <p>Output</p> <p>DONE : Maintain 1 after first operating STAT : Output the error no. in operation</p>

- (1) Give "Floating Origin" command to the axis designated as the axis of positioning module with BASE (Base no. of Positioning module) and SLOT (Slot no. of Positioning module).
- (2) This command is for setting the current position as the origin by compulsion. The address value saved on homing address will be the current position.
- (3) You can set axis to command in "AXIS" and the following value is available. If you set other values, error code "6" appears.
XBF-PN04B:1~4, XBF-PN08B:1~8

7.10.2 M code Release (XPM_MOF)

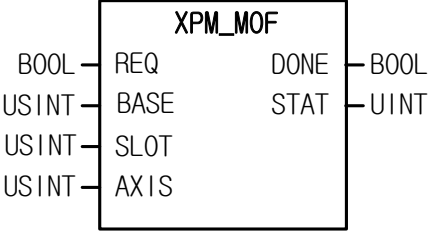
Form of Function Block	Description
	<p>Input</p> <p>REQ : Request for execution of function block BASE : Set the base no. with module SLOT : Set the slot no. with module AXIS : Axis to command XBF-PN04B:1~4, XBF-PN08B:1~8</p> <p>Output</p> <p>DONE : Maintain 1 after first operating STAT : Output the error no. in operation</p>

- (1) Give “M code Release” command to the axis designated as the axis of positioning module with BASE (Base no. of Positioning module) and SLOT (Slot no. of Positioning module).
- (2) In the case that M code of parameter of each axis is set as “With” of “After”, you may turn the M code off with this command. That is, M code signal will be OFF, M code no. will be 0.
- (3) You can set axis to command in “AXIS” and the following value is available. If you set other values, error code “6” appears.
 XBF-PN04B:1~4, XBF-PN08B:1~8

7.10.3 Latch Reset (XPM_LCLR)

Form of Function Block	Description
	<p>Input</p> <p>REQ : Request for execution of function block BASE : Set the base no. with module SLOT : Set the slot no. with module AXIS : Axis to command XBF-PN04B:1~4, XBF-PN08B:1~8 SEL: Latch reset item selection</p> <p>Output</p> <p>DONE : Maintain 1 after first operating STAT : Output the error no. in operation</p>

- (1) This command is used to initialize the data count and latch position data saved and latched on the positioning module or the state when latch is completed.
- (2) Give "Latch Reset" command to the positioning module with BASE (Base no. of Positioning module) and SLOT (Slot no. of Positioning module).
- (3) The following items are reset according to the Reset Latch items designated to SEL.
 - 0: Reset the state when latch is completed
 - 1: Reset latch position data and the state when latch is completed
(Values high than "1" are processed equally with "1")
- (4) If latch position data are read through the "Read Latch Position Data (XPM_LRD)" command after 1 is set to SEL and the "Reset Latch" command is executed, all of data become 0.
- (5) You can set axis to command in "AXIS" and the following value is available. If you set other values, error code "6" appears.
XBF-PN04B:1~4, XBF-PN08B:1~8

Remark

2 latch modes are supported for XBF-PN04B and XBF-PN08B. In case that a single trigger from two latch modes is set, ensure latch function to perform through the second touch probe 1 signal after the first touch probe 1 signal is inputted and latched.

That is, in latch single trigger mode, the Reset Latch command will execute a function to activate the next latch trigger after the touch probe 1 signal is inputted and the latch location is saved.

(Even if the Set Latch command is re-executed after it is set as latch permission, it will work in the same way)

7.10.4 Latch set (XPM_LSET)

Form of Function Block	Description
	<p>Input</p> <p>REQ : Request for execution of function block BASE : Set the base no. with module SLOT : Set the slot no. with module AXIS : Axis to command XBF-PN04B:1~4, XBF-PN08B:1~8 ENABLE: Latch enable/disable MODE: Latch mode</p> <p>Output</p> <p>DONE : Maintain 1 after first operating STAT : Output the error no. in operation</p>

- (1) This command is used to initialize the data count and latch position data saved and latched on the positioning module or the state when latch is completed.
- (2) Give “Latch Set” command to the positioning module with BASE (Base no. of Positioning module) and SLOT (Slot no. of Positioning module).
- (3) Actions according to the Enable/Disable Latch item designated to ENABLE are as following.
 0: latch prohibition 1: latch permission
 (Values high than “1” are processed equally with “1”)
- (4) Actions according to the latch mode item designated to MODE are as following.
 0: Single trigger (The current position latch is available only the touch probe 1 signal inputted at first after latch is enabled)
 1: Continuous trigger (The current position latch is available at every touch probe 1 signal after latch is enabled)
 (Values high than “1” are processed equally with “1”)
- (5) You can set axis to command in “AXIS” and the following value is available. If you set other values, error code “6” appears.
 XBF-PN04B:1~4, XBF-PN08B:1~8

7.10.5 Touch Probe (XPM_TPROBE)

Function Block type	Content																																				
<div style="border: 1px solid black; padding: 10px; width: fit-content; margin: auto;"> <p style="text-align: center;">XPM_TPROBE</p> <table style="width: 100%; border-collapse: collapse;"> <tr> <td style="width: 30%;">BOOL</td> <td style="width: 30%;">REQ</td> <td style="width: 30%;">DONE</td> <td style="width: 10%;">BOOL</td> </tr> <tr> <td>USINT</td> <td>BASE</td> <td>STAT</td> <td>UINT</td> </tr> <tr> <td>USINT</td> <td>SLOT</td> <td></td> <td></td> </tr> <tr> <td>USINT</td> <td>AXIS</td> <td></td> <td></td> </tr> <tr> <td>USINT</td> <td>TRIG_INPUT</td> <td></td> <td></td> </tr> <tr> <td>BOOL</td> <td>TRIG_MODE</td> <td></td> <td></td> </tr> <tr> <td>BOOL</td> <td>WIND_ONLY</td> <td></td> <td></td> </tr> <tr> <td>DINT</td> <td>FIRST_POS</td> <td></td> <td></td> </tr> <tr> <td>DINT</td> <td>LAST_POS</td> <td></td> <td></td> </tr> </table> </div>	BOOL	REQ	DONE	BOOL	USINT	BASE	STAT	UINT	USINT	SLOT			USINT	AXIS			USINT	TRIG_INPUT			BOOL	TRIG_MODE			BOOL	WIND_ONLY			DINT	FIRST_POS			DINT	LAST_POS			<p>Input</p> <p>REQ: Request the execution of function blocks BASE: Set the number of a base equipped with a module SLOT: Set the number of a slot equipped with a module AXIS: Designate the axis of command execution XBF-PN04B: 1-4 (Axis 1-Axis 4) XBF-PN08B: 1-8 (Axis 1-Axis 8) TRIG_INPUT: Signal to be used as a trigger 0: Rising Edge of the Touch Probe 1 1: Rising Edge of the Touch Probe 2 2: Falling Edge of the Touch Probe 1 3: Falling Edge of the Touch Probe 2 4: Index (Z) Pulse of the Touch Probe 1 5: Index (Z) Pulse of the Touch Probe 2 TRIG_MODE: Trigger Mode Setting 0: Single trigger 1: Double trigger WIND_MODE: Windowed Mode Setting 0: Inactive 1: Active FIRST_POS: Start position allowing windowed mode -2,147,483,648 ~ 2,147,483,647 LAST_POS: End position allowing windowed mode -2,147,483,648 ~ 2,147,483,647</p> <p>Output</p> <p>DONE: Maintain 1 after initial operation STAT: Output an error code that occurred during the execution of function blocks</p>
BOOL	REQ	DONE	BOOL																																		
USINT	BASE	STAT	UINT																																		
USINT	SLOT																																				
USINT	AXIS																																				
USINT	TRIG_INPUT																																				
BOOL	TRIG_MODE																																				
BOOL	WIND_ONLY																																				
DINT	FIRST_POS																																				
DINT	LAST_POS																																				

- (1) This is a command used to set up touch probe functions of positioning modules.
 - (2) Set the rising and falling edges, and half of a touch probe according to TRIG_INPUT set to the AXIS of a positioning module designated by BASE (the base number of a positioning module) and SLOT (the slot number of a positioning module). And the command to set a trigger mode is given according to items designated in TRIG_MODE.
 - (3) Actions according to the trigger input signal designated in TRIG_INPUT are as follows: When setting values other than the setting value, "Error Code 756" occurs.

0: Rising Edge of the Touch Probe 1	1: Rising Edge of the Touch Probe 2
2: Falling Edge of the Touch Probe 1	3: Falling Edge of the Touch Probe 2
4: Index (Z) Pulse of the Touch Probe 1	5: Index (Z) Pulse of the Touch Probe 2
- Index (Z) pulse, and rising and falling edges of each touch probe can not be run simultaneously.

(4) Actions according to the trigger mode designated in TRIG_MODE are as follows:

- 0: Single trigger
- 1: Double trigger

(5) When activating WIND_MODE, a tolerance area to receive a trigger signal of an axis can be set. When a windowed mode is activated, only a single trigger operates.

(6) The axis of command execution is set to AXIS and the following values can be set to it: When setting values other than the setting value, "Error Code 6" occurs.

XBF-PN04B: 1-4 (Axis 1-Axis 4), XBF-PN08B: 1-8 (Axis 1-Axis 8)

(7) The commands to set touch probes are ones only for XBF-PN04B and XBF-PN08B.

(8) The Supported versions of the Function Block are as follows:

- XBF-PN04B, XBF-PN08B OS: V1.80 or higher
- XB(E)C-DxxxU,UA,UP OS: V1.90 or higher,
- XB(E)M-DxxxH2,HP OS: V2.20 or higher
- XG5000: V4.29 or higher

7.10.6 Trigger Abortion (XPM_ABORTT)

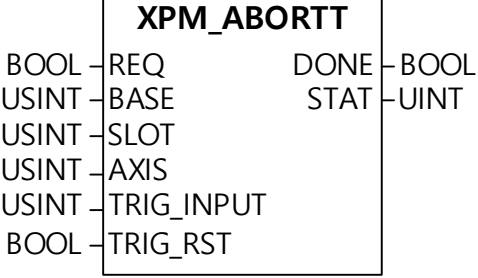
Function Block type	Content
	<p>Input</p> <p>REQ: Request the execution of function blocks BASE: Set the number of a base equipped with a module SLOT: Set the number of a slot equipped with a module AXIS: Designate the axis of command execution XBF-PN04B: 1-4 (Axis 1-Axis 4) XBF-PN08B: 1-8 (Axis 1-Axis 8) TRIG_INPUT: Signal to abort triggers 0: Rising Edge of the Touch Probe 1 1: Rising Edge of the Touch Probe 2 2: Falling Edge of the Touch Probe 1 3: Falling Edge of the Touch Probe 2 4: Index (Z) Pulse of the Touch Probe 1 5: Index (Z) Pulse of the Touch Probe 2 TRIG_RST: Set to abort triggers 0: Trigger Abortion 1: Trigger Abortion and Reset Position Data</p> <p>Output</p> <p>DONE: Maintain 1 after initial operation STAT: Output an error code that occurred during the execution of function blocks</p>

- (1) This is a command used to abort trigger functions of positioning modules.
- (2) Abort waiting triggers in the rising and falling edges, and half of a touch probe according to TRIG_INPUT set to the AXIS of a positioning module designated by BASE (the base number of a positioning module) and SLOT (the slot number of a positioning module). And the command to set a trigger reset mode is given according to items designated in TRIG_RST.
- (3) Actions according to the trigger input signal designated in TRIG_INPUT are as follows: When setting values other than the setting value, "Error Code 756" occurs.
 - 0: Rising Edge of the Touch Probe 1
 - 1: Rising Edge of the Touch Probe 2
 - 2: Falling Edge of the Touch Probe 1
 - 3: Falling Edge of the Touch Probe 2
 - 4: Index (Z) Pulse of the Touch Probe 1
 - 5: Index (Z) Pulse of the Touch Probe 2
- (4) Actions according to the trigger abortion mode designated in TRIG_RST are as follows:
 - 0: Trigger Abortion
 - 1: Trigger Abortion and Reset Position Data
- (5) The commands to abort triggers are ones only for XBF-PN04B and XBF-PN08B.
- (6) The version information that can use the command to abort triggers is as follows:

7.11 Other Function Blocks related with the Servo Driver

7.11.1 Servo Communication Connect (XPM_ECON)

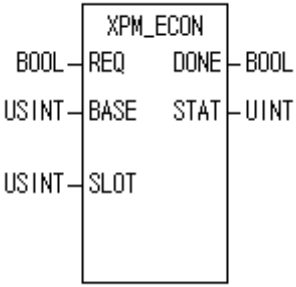
Form of Function Block	Description
	<p>Input</p> <p>REQ : Request for execution of function block BASE : Set the base no. with module SLOT : Set the slot no. with module</p> <p>Output</p> <p>DONE : Maintain 1 after first operating STAT : Output the error no. in operation</p>

- (1) Give “Servo Communication Connect” command to the positioning module with BASE (Base no. of Positioning module) and SLOT (Slot no. of Positioning module).
- (2) If servo driver is connected normally, the bit corresponding to the connected axis among automatic registration variables will be set.

	Automatic registration variable	Contents
1-axis	_00yy_A1_RDY	1-axis ready
2-axis	_00yy_A2_RDY	2-axis ready
3-axis	_00yy_A3_RDY	3-axis ready
4-axis	_00yy_A4_RDY	4-axis ready
5-axis	_00yy_A5_RDY	5-axis ready
6-axis	_00yy_A6_RDY	6-axis ready
7-axis	_00yy_A7_RDY	7-axis ready
8-axis	_00yy_A8_RDY	8-axis ready

(* “yy” of _00yy means slot number.)

7.11.2 Servo Communication Disconnect (XPM_DCON)

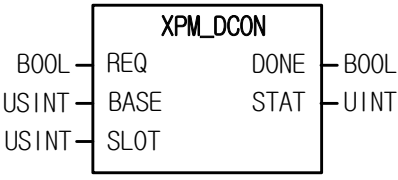
Form of Function Block	Description
	<p>Input</p> <p>REQ : Request for execution of function block BASE : Set the base no. with module SLOT : Set the slot no. with module</p> <p>Output</p> <p>DONE : Maintain 1 after first operating STAT : Output the error no. in operation</p>

- (1) Give “Servo Communication Disconnect” command to the positioning module with BASE (Base no. of Positioning module) and SLOT (Slot no. of Positioning module).
- (2) If servo driver is disconnected normally, the bit corresponding to the connected axis among automatic registration variables will be cleared.

	Automatic registration variable	Contents
1-axis	_00yy_A1_RDY	1-axis ready
2-axis	_00yy_A2_RDY	2-axis ready
3-axis	_00yy_A3_RDY	3-axis ready
4-axis	_00yy_A4_RDY	4-axis ready
5-axis	_00yy_A5_RDY	5-axis ready
6-axis	_00yy_A6_RDY	6-axis ready
7-axis	_00yy_A7_RDY	7-axis ready
8-axis	_00yy_A8_RDY	8-axis ready

(* “yy” of _00yy means slot number.)

7.11.3 Servo On (XPM_SVON)

Form of Function Block	Description
	<p>Input</p> <p>REQ : Request for execution of function block BASE : Set the base no. with module SLOT : Set the slot no. with module AXIS : Axis to command XBF-PN04B:1~4, XBF-PN08B:1~8</p> <p>Output</p> <p>DONE : Maintain 1 after first operating STAT : Output the error no. in operation</p>

- (1) Give “Servo Ont” command to the axis designated as the axis of positioning module with BASE (Base no. of Positioning module) and SLOT (Slot no. of Positioning module).
- (2) Give “Servo On” Command to the servo corresponding to the selected axis among the servos connected to the module.
- (3) In order to operate a motor, Servo On signal have to be on.
- (4) You can set axis to command in “AXIS” and the following value is available. If you set other values, error code “6” appears.
 XBF-PN04B:1~4, XBF-PN08B:1~8

7.11.4 Servo Off (XPM_SVOFF)

Form of Function Block	Description
	<p>Input</p> <p>REQ : Request for execution of function block BASE : Set the base no. with module SLOT : Set the slot no. with module AXIS : Axis to command XBF-PN04B:1~4, XBF-PN08B:1~8</p> <p>Output</p> <p>DONE : Maintain 1 after first operating STAT : Output the error no. in operation</p>

- (1) Give “Servo On” command to the axis designated as the axis of positioning module with BASE (Base no. of Positioning module) and SLOT (Slot no. of Positioning module).
- (2) Give “Servo Off” Command to the servo corresponding to the selected axis among the servos connected to the module.
- (3) You can set axis to command in “AXIS” and the following value is available. If you set other values, error code “6” appears.
XBF-PN04B:1~4, XBF-PN08B:1~8

7.11.5 Servo Error Reset (XPM_SRST)

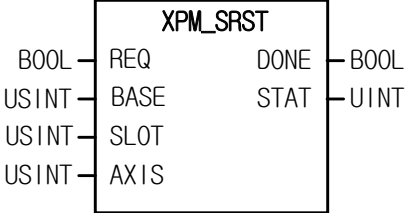
Form of Function Block	Description
	<p>Input</p> <p>REQ : Request for execution of function block BASE : Set the base no. with module SLOT : Set the slot no. with module AXIS : Axis to command XBF-PN04B:1~4, XBF-PN08B:1~8</p> <p>Output</p> <p>DONE : Maintain 1 after first operating STAT : Output the error no. in operation</p>

- (1) Give "Servo Error Reset" command to the axis designated as the axis of positioning module with BASE (Base no. of Positioning module) and SLOT (Slot no. of Positioning module).
- (2) Give the command that clears servo driver alarm occurred at the specific axis among servo drivers connected to the positioning module.
- (3) If you reset the servo driver alarm without removing reason, it may not be cleared. So before resetting the servo driver alarm, remove the reason why alarm occurs.
- (4) You can set axis to command in "AXIS" and the following value is available. If you set other values, error code "6" appears.
 XBF-PN04B:1~4, XBF-PN08B:1~8
- (5) There may be servo error which can't be reset according to error type among EtherCAT servo drivers. So refer to servo driver manual.

7.11.6 Servo Error History Reset (XPM_SHRST)

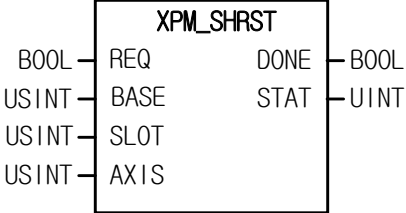
Form of Function Block	Description
	<p>Input</p> <p>REQ : Request for execution of function block BASE : Set the base no. with module SLOT : Set the slot no. with module AXIS : Axis to command XBF-PN04B:1~4, XBF-PN08B:1~8</p> <p>Output</p> <p>DONE : Maintain 1 after first operating STAT : Output the error no. in operation</p>

- (1) Give "Servo Error Reset" command to the axis designated as the axis of positioning module with BASE (Base no. of Positioning module) and SLOT (Slot no. of Positioning module).
- (2) Give the command that clears servo driver alarm history occurred at the specific axis among servo drivers connected to the positioning module.
- (3) Servo drive can save up to 10 servo alarm history.
- (4) You can set axis to command in "AXIS" and the following value is available. If you set other values, error code "6" appears.
XBF-PN04B:1~4, XBF-PN08B:1~8
- (5) servo error history reset is not supported.

7.11.7 Servo External Input Information Read (XPM_SVIRD)

Form of Function Block	Description																
<div style="border: 1px solid black; padding: 10px; width: fit-content; margin: auto;"> <p style="text-align: center; margin: 0;">XPM_SVIRD</p> <table style="width: 100%; border-collapse: collapse;"> <tr> <td style="border-right: 1px solid black; padding: 2px;">BOOL</td> <td style="padding: 2px;">REQ</td> <td style="padding: 2px;">DONE</td> <td style="border-left: 1px solid black; padding: 2px;">BOOL</td> </tr> <tr> <td style="border-right: 1px solid black; padding: 2px;">USINT</td> <td style="padding: 2px;">BASE</td> <td style="padding: 2px;">STAT</td> <td style="border-left: 1px solid black; padding: 2px;">UINT</td> </tr> <tr> <td style="border-right: 1px solid black; padding: 2px;">USINT</td> <td style="padding: 2px;">SLOT</td> <td style="padding: 2px;">SV_IN</td> <td style="border-left: 1px solid black; padding: 2px;">UDINT</td> </tr> <tr> <td style="border-right: 1px solid black; padding: 2px;">USINT</td> <td style="padding: 2px;">AXIS</td> <td></td> <td></td> </tr> </table> </div>	BOOL	REQ	DONE	BOOL	USINT	BASE	STAT	UINT	USINT	SLOT	SV_IN	UDINT	USINT	AXIS			<p>Input</p> <p>REQ : Request for execution of function block BASE : Set the base no. with module SLOT : Set the slot no. with module AXIS : Axis to command XBF-PN04B:1~4, XBF-PN08B:1~8</p> <p>Output</p> <p>DONE : Maintain 1 after first operating STAT : Output the error no. in operation SV_IN: Servo input signal information</p>
BOOL	REQ	DONE	BOOL														
USINT	BASE	STAT	UINT														
USINT	SLOT	SV_IN	UDINT														
USINT	AXIS																

- (1) Give "Servo External Input Information Read" command to the axis of positioning module designated with BASE (Base no. of Positioning module) and SLOT (Slot no. of Positioning module).
- (2) This is command reading input signal state of the servo driver corresponding to the selected axis among servos connected to the module
- (3) Input signal state is outputted at SV_IN.
- (4) You can set axis to command in "AXIS" and the following value is available. If you set other values, error code "6" appears. XBF-PN04B:1~4, XBF-PN08B:1~8

7.11.8 Servo Parameter Read (XPM_SVPRD)

Form of Function Block		Description																					
<div style="border: 1px solid black; padding: 5px; width: fit-content; margin: auto;"> <p style="text-align: center;">XPM_SVPRD</p> <table style="width: 100%; border-collapse: collapse;"> <tr> <td style="width: 30%;">BOOL — REQ</td> <td style="width: 30%;"></td> <td style="width: 30%;">DONE — BOOL</td> </tr> <tr> <td>USINT — BASE</td> <td></td> <td>UINT — STAT</td> </tr> <tr> <td>USINT — SLOT</td> <td></td> <td>DINT — DATA</td> </tr> <tr> <td>USINT — AXIS</td> <td></td> <td></td> </tr> <tr> <td>UINT — INDEX</td> <td></td> <td></td> </tr> <tr> <td>USINT — SUBINDEX</td> <td></td> <td></td> </tr> <tr> <td>USINT — LENGH</td> <td></td> <td></td> </tr> </table> </div>		BOOL — REQ		DONE — BOOL	USINT — BASE		UINT — STAT	USINT — SLOT		DINT — DATA	USINT — AXIS			UINT — INDEX			USINT — SUBINDEX			USINT — LENGH			<p>Input</p> <p>REQ : Request for execution of function block BASE : Set the base no. with module SLOT : Set the slot no. with module AXIS : Axis to command XBF-PN04B:1~4, XBF-PN08B:1~8 INDEX: Servo parameter object Index SUBINDEX: Servo paramter object subindex LENGTH: Servo parameter object size</p> <p>Output</p> <p>DONE : Maintain 1 after first operating STAT : Output the error no. in operation DATA: Read servo parameter data</p>
BOOL — REQ		DONE — BOOL																					
USINT — BASE		UINT — STAT																					
USINT — SLOT		DINT — DATA																					
USINT — AXIS																							
UINT — INDEX																							
USINT — SUBINDEX																							
USINT — LENGH																							

- (1) This is the command that reads parameters (CoE object) of the servo driver connected to positioning module.
- (2) Give "Servo Parameter Read" command to the axis of positioning module designated with BASE (Base no. of Positioning module) and SLOT (Slot no. of Positioning module).
- (3) Save in DATA to read value of LENGTH size at the servo parameter object designated with INDEX, SUBINDEX, at the axis designated with BASE (Base no. of Positioning module) and SLOT (Slot no. of Positioning module).
- (4) You can set axis to command in "AXIS" and the following value is available. If you set other values, error code "6" appears. XBF-PN04B:1~4, XBF-PN08B:1~8
- (5) INDEX can be set as follows. If you set wrongly, "Error11" arises at STATE.

Set value	Description
0x1000 ~ 0x1FFF	Communication Profile Area
0x2000 ~ 0x5FFF	Manufacturer Specific Profile Area
0x6000 ~ 0x9FFF	Standardized Device Profile Area

- (6) SUBINDEX can be set as follows. If you set wrongly, "Error11" arises at STATE.

Set value	Description
0x0 ~ 0xFF	Object Subindex of servo parameter

- (7) LENGTH can be set as follows. If you set wrongly, "Error11" arises at STATE.

Set value	Description
1 ~ 4	Object Byte Length of servo parameter

7.11.9 Servo Parameter Write (XPM_SVPWR)

Form of Function Block	Description
	<p>Input</p> <p>REQ : Request for execution of function block BASE : Set the base no. with module SLOT : Set the slot no. with module AXIS : Axis to command XBF-PN04B:1~4, XBF-PN08B:1~8 INDEX : Servo parameter object Index SUBINDEX : Servo paramter object subindex LENGTH : Servo parameter object size DATA: Servo parameter value RAM/ROM : how to save parameter 0: save at RAM, 1: save at ROM</p> <p>Output</p> <p>DONE : Maintain 1 after first operating STAT : Output the error no. in operation</p>

- (1) This is the function block that changes parameters (CoE object) of the servo driver connected to positioning module
- (2) Give “Servo Parameter Write” command to the axis of positioning module designated with BASE (Base no. of Positioning module) and SLOT (Slot no. of Positioning module).
- (3) If you want to save at the internal ROM of the servo driver with “Servo parameter write” command, set up 1 at RAM/ROM and execute the command, or set up 0 at RAM/ROM and execute the command and later save them at servo driver EEPROM with XPM_SVSAVE command.
- (4) Save DATA of LENGTH size at the servo parameter object designated with INDEX, SUBINDEX, at the axis designated with BASE (Base no. of Positioning module) and SLOT (Slot no. of Positioning module).
- (5) You can set axis to command in “AXIS” and the following value is available. If you set other values, error code “6” appears. XBF-PN04B:1~4, XBF-PN08B:1~8
- (6) You can set INDEX as follows. If you set wrongly, “Error11” arises

Setting value	Description
0x2000 ~ 0x5FFF	Manufacturer Specific Profile Area
0x6000 ~ 0x9FFF	Standardized Device Profile Area

- (7) You can set SUBINDEX as follows. If you set wrongly, “Error11” arises

Setting value	Description
0x0~0xFF	Servo parameter Object Subindex

- (8) You can set SUBINDEX as follows. If you set wrongly, “Error11” arises

Setting value	Description
1~4	Servo parameter Object Byte Length

- (9) You can set SUBINDEX as follows.

Setting value	Teaching method
0	RAM teaching
1	ROM teaching

7.11.10 Servo Parameter Save (XPM_SVSAVE)

Form of Function Block	Description
	<p>Input</p> <p>REQ : Request for execution of function block BASE : Set the base no. with module SLOT : Set the slot no. with module AXIS : Axis to command XBF-PN04B:1~4, XBF-PN08B:1~8 SAVE_AXIS: Set the axis to save by setting each bit (bit 0~7: 1-axis~8-axis)</p> <p>Output</p> <p>DONE : Maintain 1 after first operating STAT : Output the error no. in operation</p>

- (1) This is the function block that saves parameters of the servo driver connected to positioning module at the EEPROM of the servo driver.
- (2) Give "Servo Parameter Save" command to the axis of positioning module designated with BASE (Base no. of Positioning module) and SLOT (Slot no. of Positioning module).
- (3) This is the function block that save the selected servo parameter of servo drive among connected servo drive to EEPROM of internal servo drive.
- (4) Set up the axis to give a command at AXIS and you can set as follows. If you set wrongly, "Error6" arises. Command axis is different with the axis for saving servo parameter. If you want to save servo parameter of the command axis, set the corresponding bit at SAVE_AXIS.
XBF-PN04B:1~4, XBF-PN08B:1~8
- (5) Set up the servo driver axis at SAVE_AXIS. If you set wrongly, "Error11" arises. Bit 0 ~ 7 : 1-axis ~ 8-axis

Chapter 8 Program

Here describes the basic program that operate positioning module case by using its commands.

8.1 Example of XBC(MK) Programming

8.1.1 General description

Here we supposed the positioning module installed at the slot no.3 of the 0 base. In the real usage, you need to change its value according to your actual set up.

8.1.2 Current State Read

(1) Using XSRD command

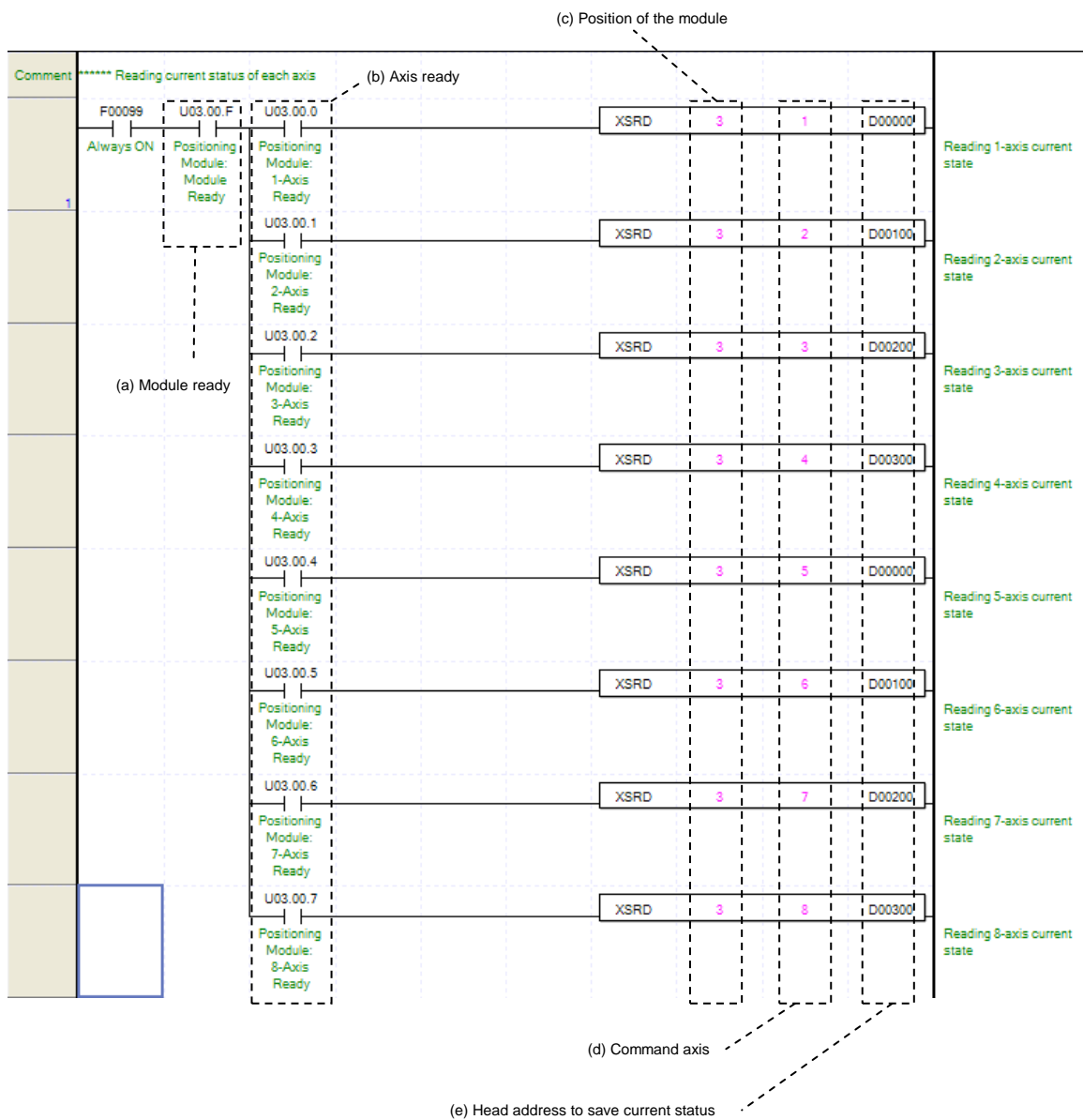

- (a) Module's ready
After Turn On, if there is no error occurred in Positioning Module, it is "ON," meaning that modules are ready to operate.
- (b) Axis ready
If communication between the positioning module and the servo driver is normal, corresponding signal will be on. In the example program, since F00099 (Always ON), positioning module ready (Uxx.00.F) and axis ready (Uxx.00.0 ~ Uxx.00.7) are used, if there is no error in the module, it reads the current status every scan.
- (c) Address of Positioning Module
Before operation, you need to configure its position by numbers. In this example, Positioning Module installed at the slot no.3.
- (d) Axis of operation
Positioning module operate as 4 axis. In this example, number 1 through 4 means axis 1 through axis 4.
- (e) Address of first device where those conditions of current axis are saved
This D00000 tells the address of first device which already register from the configuration of sequence program. For example, in this program above, the condition of axis 1 will be saved from D00000 to D00030. How to setup a device function would be explained at the "Chapter 6.3.42 Reading Driving Condition."
- (f) Also you can use the bit information from saved data in the device for as a condition of another operation. For example, in this program above, according to use axis 1 driving signal, you need to setup a data as D00000.0, and to check error condition of axis 2, you need to configure as D0000.1.

(2) Using command Get

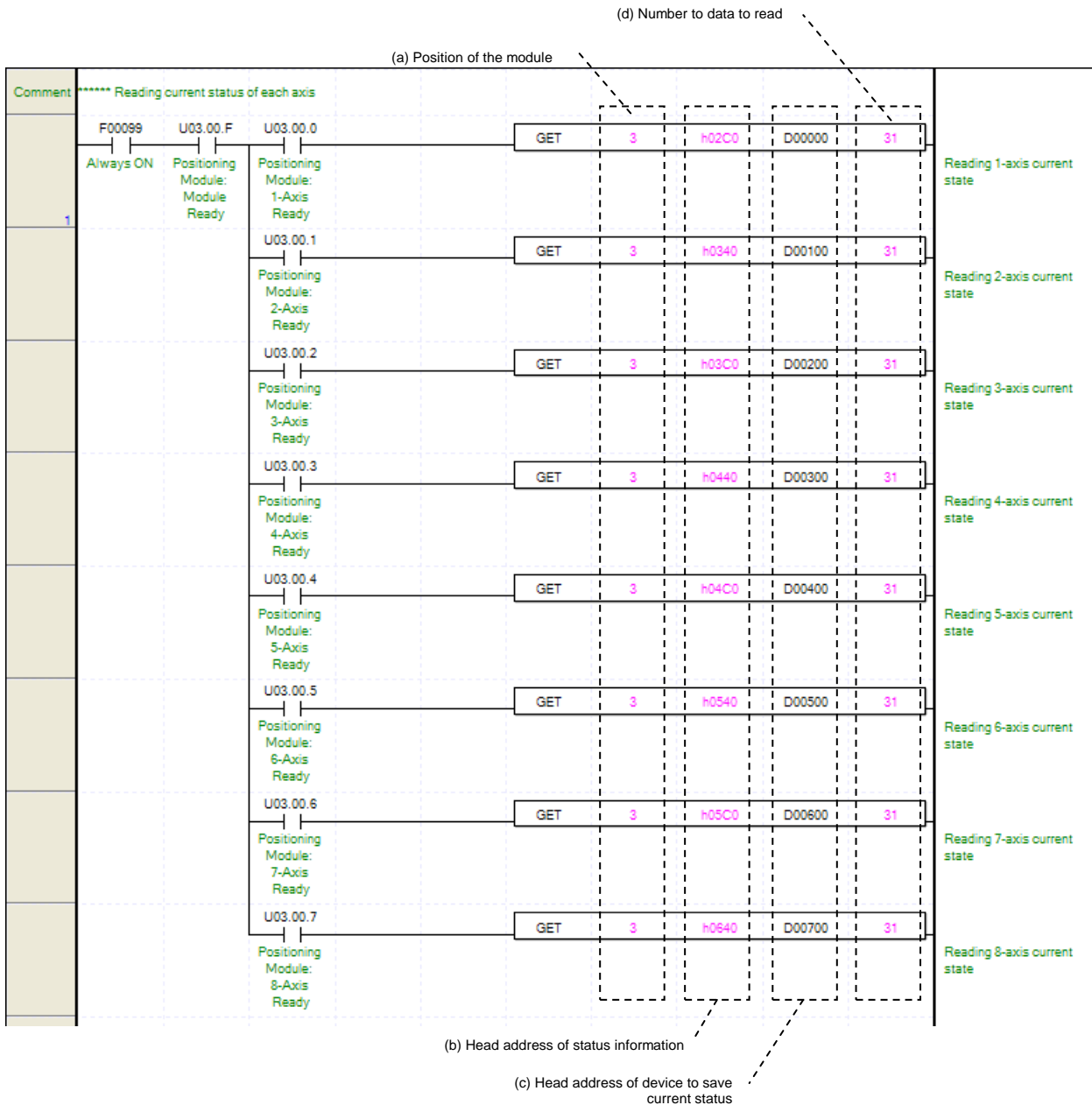

(a) The address of Positioning Module.

(b) The first memory address of operating Axis.

You can setup the memory address of condition information case by axis. For example, in this program above, "h0200" refers that condition information of 3axis. How to setup a memory address by axis would be explained at "Chapter 5.1.5 Condition Information."

(c) The first address of device which can save the condition of axis

(d) Number of reading data by WORD

Using command GET to read condition information, can save number of data by WORD, hence you only chosen data will be saved.

(e) Also you can use the bit information from saved GET data in the device for as a condition of another operation.

For example, in this program above, according to use axis 1 driving signal, you need to setup a data as D00000.0, and to check error condition of axis 2, you need to configure as D00001.1.

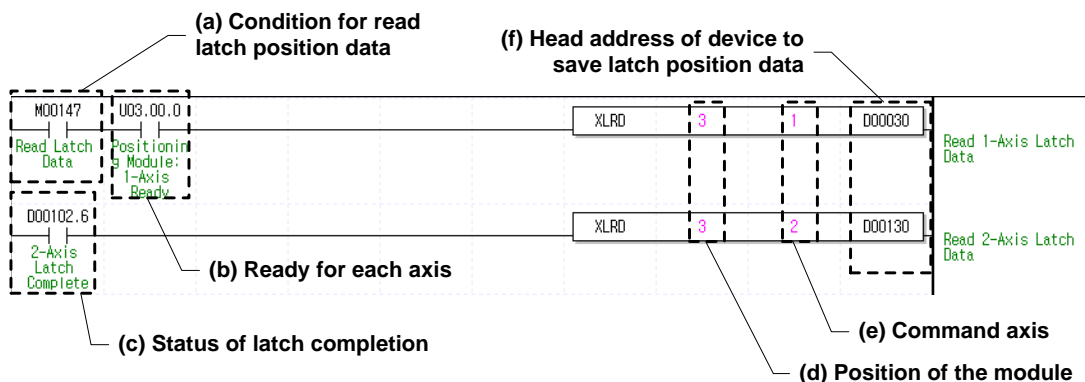
(3) Latch Position Data Read**(a) Conditions for Latch Position Data Read**

Conditions to implement the Latch Position Data Read command (XLRD). For Axis 1, the Latch Position Data Read command is always implemented if M00147 is On after the axis is connected with the network.

(b) Axis ready

If communication between the positioning module and the servo driver is normal, corresponding signal will be on. In the example program, latch position data are read if M00147 (Conditions to read latch data) is On after the axis is connected with the module since Axis 1 ready state (Uxx.00.0) is used.

(c) Latch Completion state

It is the state of "Latch Completion" when an example program of "8.1.2 Read the Current State is used." It is on when latch is completed once external latch command signal of the relevant axis is inputted. In case of Axis 2, the Latch Position Data Read command of Axis 2 is implemented as soon as D00102.6 (Latch Completion state) is On.

(d) Position of the module

In order to give a command, you have to specify the position of the positioning module to give a command. In the example, the positioning module is mounted on the slot 3.

(e) Command axis

When giving a command to each axis, you have to specify an axis to give a command. XBF-PN04(8)B can support up to 4(8) axis, 1~4(8) in command means 1-axis ~ 4(8)-axis.

(f) Leading address of the device to save Axis's latch position data

It is the leading address of the device to save the axis's latch data value read from the positioning module by using XLRD. This device can be used on sequence programs. For example, Axis 1's data count of latch position is saved on D00030 and latch position data 1 ~ 10 are saved on D10032 through D00050 the example program above. For further information on the saved device, refer to 6.3.56 Latch Position Data Read command (Command: XLRD)."

8.1.3 Operation Ready

(1) Servo driver connection

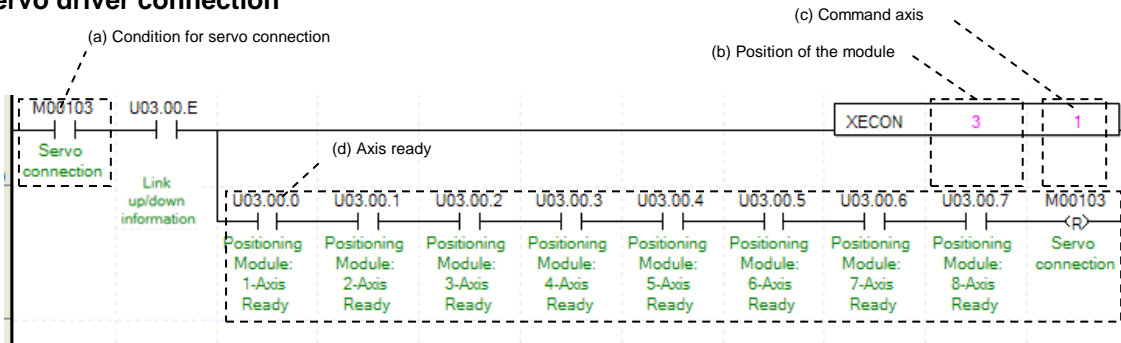

- (a) Condition for servo connection
Condition to execute Servo connection command (XECON)
- (b) Position of the module
In order to give a command, you have to specify the position of the positioning module to give a command. In the example, the positioning module is mounted on the slot 3.
- (c) Command axis
When giving a command to each axis, you have to specify an axis to give a command. XBF-PN04(8)B can supports up to 4(8) axis, 1~4(8) in command means 1-axis ~ 4(8)-axis.
- (d) Axis ready
If connection with servo driver is complete, the signal corresponding to each axis will be on. In the example, we assume that 8 axis are connected to the module. Set the only connected axis according to the system. If connection is complete and all signals corresponding to each axis is on, it resets servo connection condition.
- (e) If you use Link up/down information as input condition of servo connection command, you can execute servo connection command only when the network cable is actually connected.

(2) Servo driver disconnection

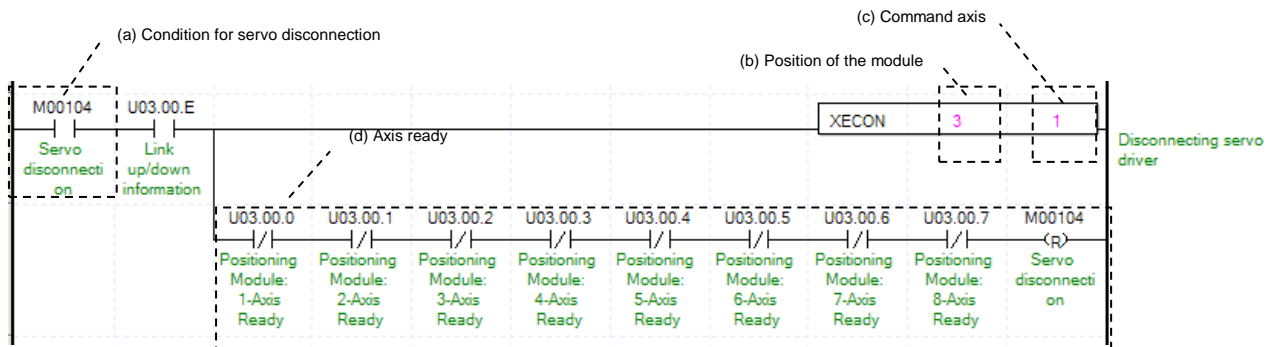

- (a) Condition for servo disconnection
Condition to execute Servo disconnection command (XDCON)
- (b) Position of the module
- (c) Command axis
When giving a command to each axis, you have to specify an axis to give a command. XBF-PN04(8)B can supports up to 4(8) axis, 1~4(8) in command means 1-axis ~ 4(8)-axis.
- (d) Axis ready
If disconnection with servo driver is complete, the signal corresponding to each axis will be off. In the example, we assume that 8 axis are connected to the module. Set the only connected axis according to the system. If connection is complete and all signals corresponding to each axis is off, it resets servo disconnection condition.
- (e) If you use Link up/down information as input condition of servo disconnection command, you can execute servo disconnection command only when the network cable is actually connected.

(3) Servo On

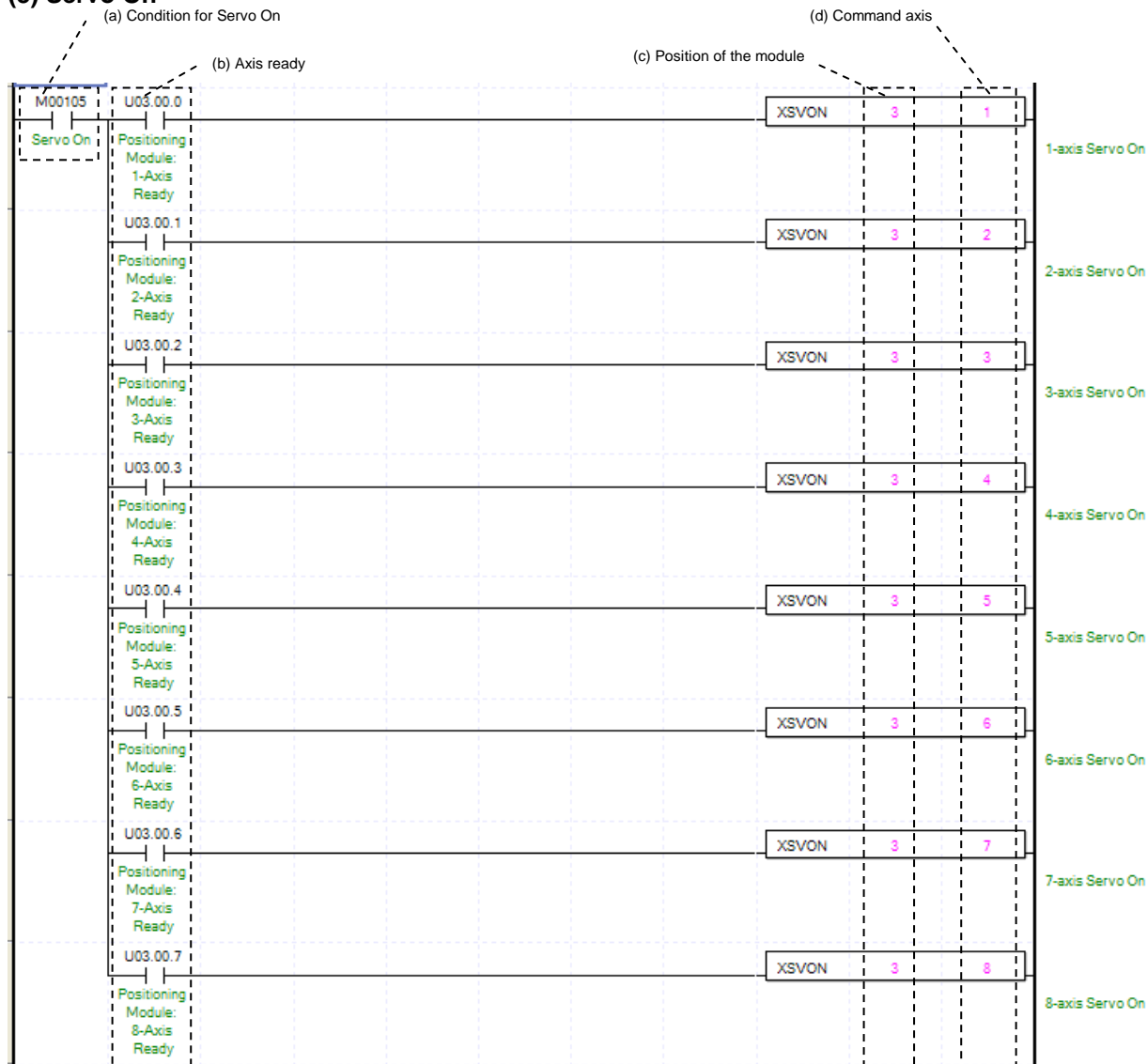

(a) Condition for Servo On command
Condition for Servo On command (XSVON)

(b) Axis ready

If communication between the positioning module and the servo driver is normal, the signal corresponding to the connected axis will be on. In the example, if condition for Servo On command is on, it will give a Servo On command to the connected axis. You can remove the command of the axis not connected according to the system.

(c) Position of the positioning module

In the example, we assume that the module is equipped on Base 0, Slot 3.

(d) Command axis

When giving a command to each axis, you have to specify an axis to give a command. XBF-PN04(8)B can supports up to 4(8) axis, 1~4(8) in command means 1-axis ~ 4(8)-axis.

(e) If Servo On command is executed, the servo driver of each axis will be "Servo On" status.

(4) Servo Off

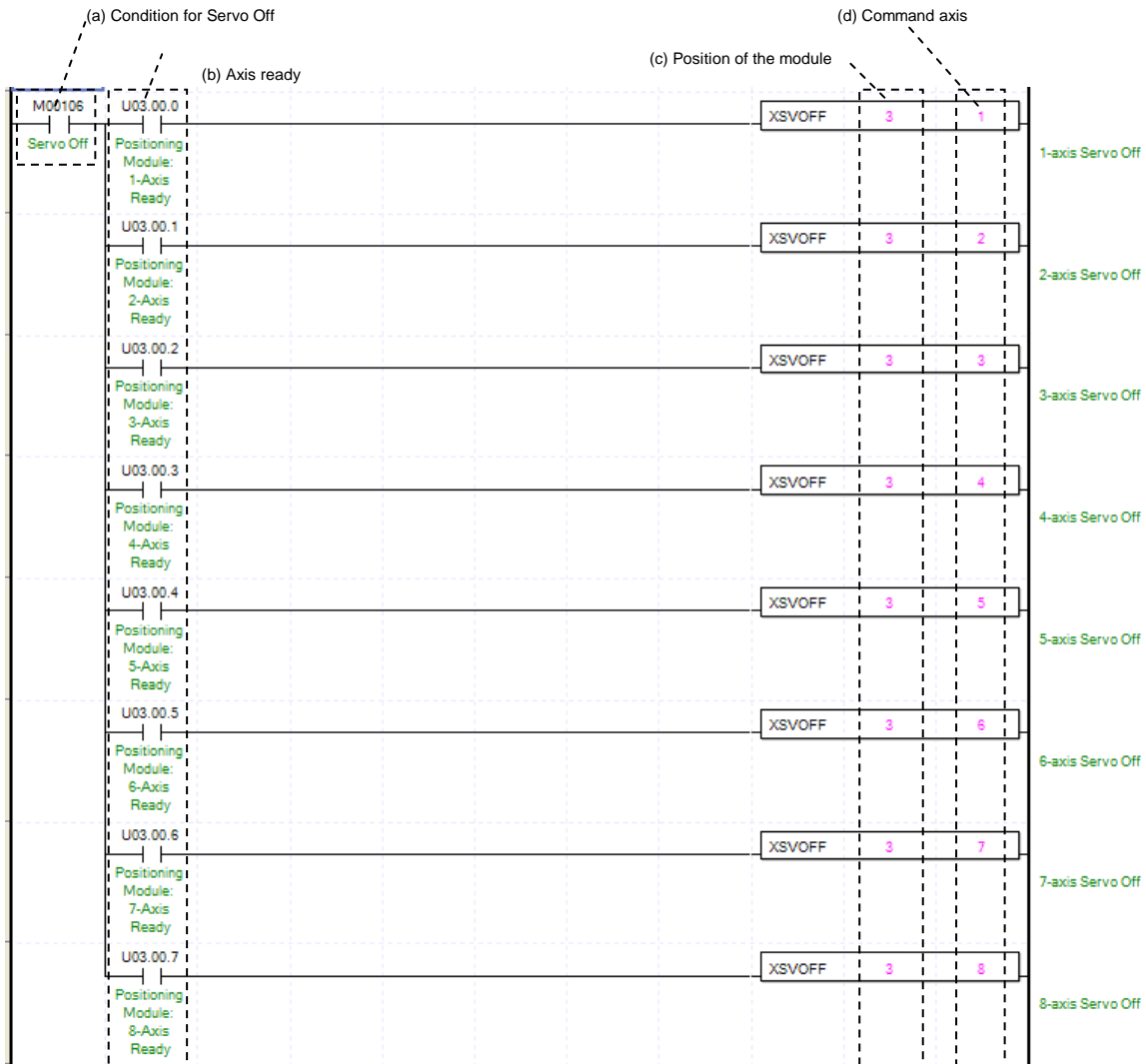

(a) Condition for Servo Off command
Condition for Servo Off command (XSVOFF)

(b) Axis ready
If communication between the positioning module and the servo driver is normal, the signal corresponding to the connected axis will be on. In the example, if condition for Servo Off command is on, it will give a Servo Off command to the connected axis. You can remove the command of the axis not connected according to the system.

(c) Position of the positioning module
In the example, we assume that the module is equipped on Base 0, Slot 3.

(d) Command axis
When giving a command to each axis, you have to specify an axis to give a command. XBF-PN04(8)B can supports up to 4(8) axis, 1~4(8) in command means 1-axis ~ 4(8)-axis.

(e) If Servo Off command is executed, the servo driver of each axis will be “Servo Off” status.

8.1.4 Operation Test

(1) Floating Origin Setting

Decide origin of current motor's position without set a machinery origin.

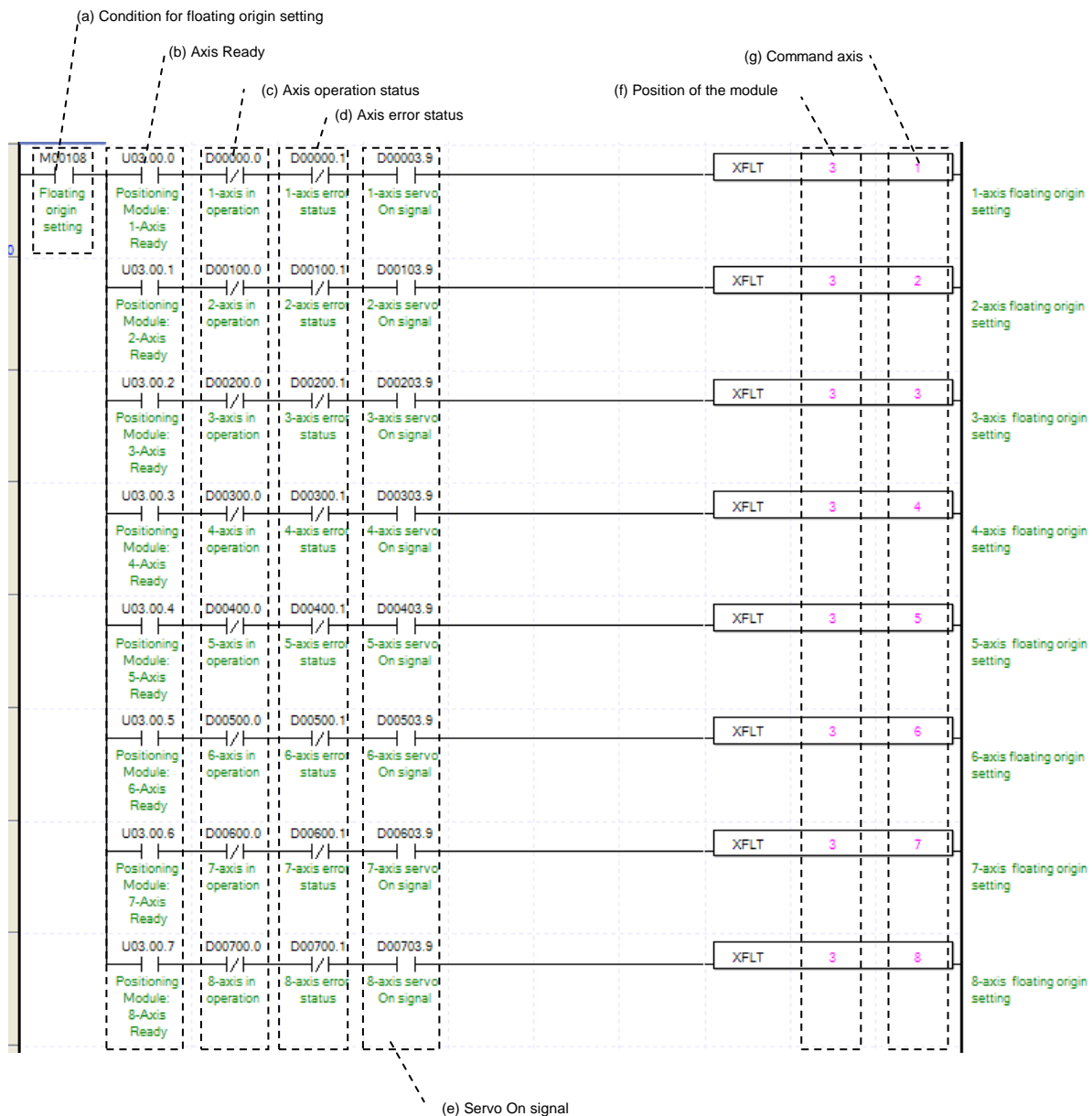

(a) Condition of running a Floating Origin Setting

It only works with XFLT command.

(b) Axis Ready

If communication between the positioning module and the servo driver is normal, the signal corresponding to each axis will be on.

(c) Operating state by axis

According to exercise from "Chapter 8.1.2 Current State Reading," it is a signal of "Operating" for each axis.

(d) Error state for each axis

According to exercise from "Chapter 8.1.2 Current State Reading," it is a signal of "Error state" for each axis. It turns on when an error occurred. Operation will only work when there is no error. If you want to operate a system regardless of errors, you can just inactivate the function.

(e) Servo On signal

When applying the example program of “8.1.2 Current State Read”, this is “Servo On” signal for each axis. When each axis is Servo On state, it will be on. Since floating origin setting command can't be executed when the axis is not servo on, it makes command executed when servo driver is “Servo On” state. If you execute floating origin setting command when axis is not Servo On state, the error 212 occurs.

(f) Address of Positioning Module

In this example, Positioning Module installed at the slot no.3 of 0 bases.

(g) Axis of command execution

You can set an axis for Floating Origin Setting. XBF-PN04(8)B can supports for 4(8) axes. In the “execution of axis” from the configuration of Floating Origin Setting, you can set a value for axis 1 through 4(8) axis.

(2) Jog Operation

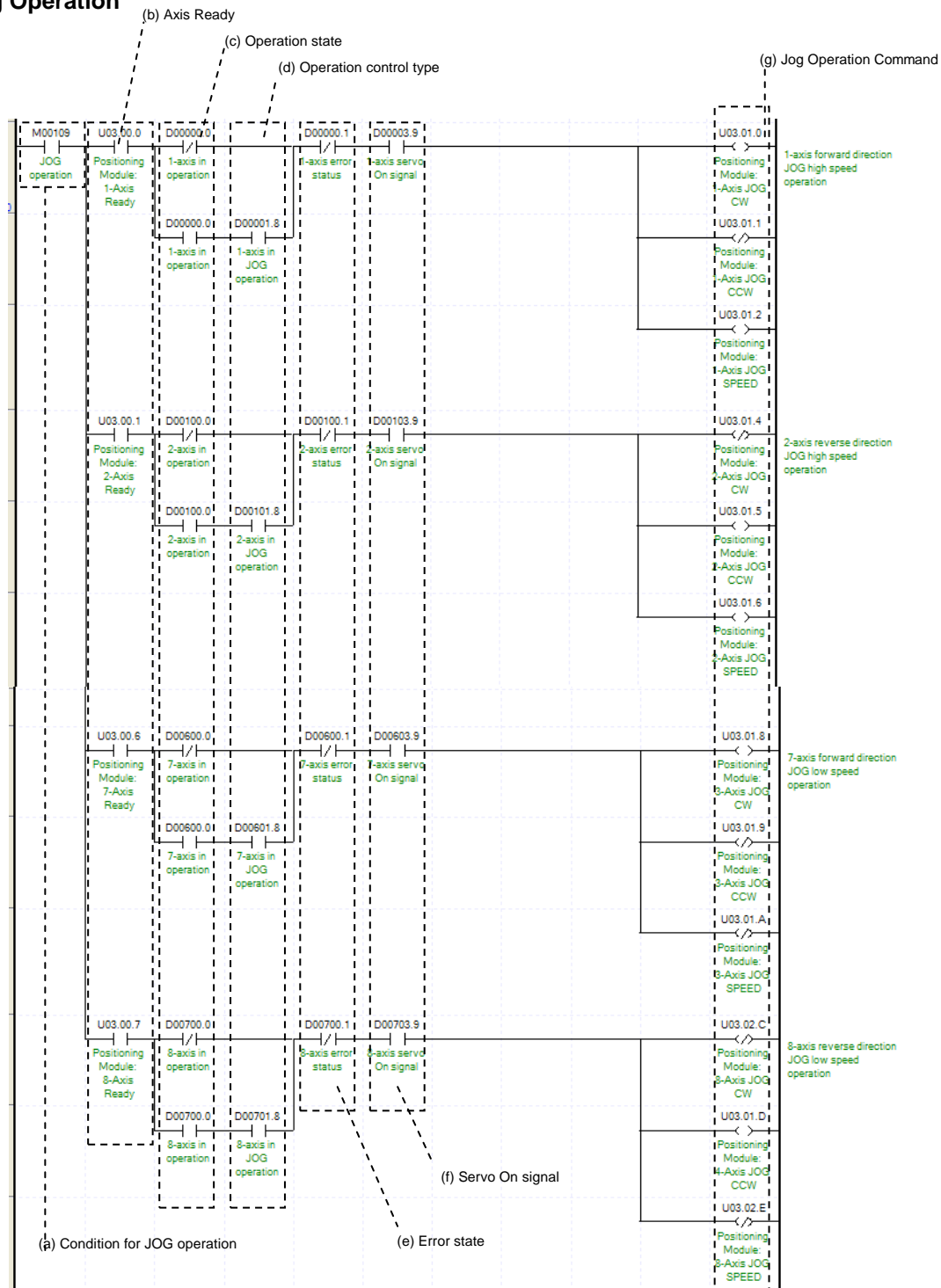

(a) Condition of Jog Operation

Condition of Jog Operation Command

(b) Axis Ready

If communication between the positioning module and the servo driver is normal, the signal corresponding to each axis will be on.

(c) Operating state by axis

Jog Operation can only be working when the state of axis set as Jog Operation. In this example above, specific axis set as Jog Operation otherwise it is not operating.

(d) State of driving control by axis

According to exercise from "Chapter 8.1.2 Current State Reading," it is a signal of "Jog Operating" for each axis. It turns on when it is operating. Jog Operation configuration can be changed while it is operating.

(e) Error state for each axis

According to exercise from "Chapter 8.1.2 Current State Reading," it is a signal of "Error state" for each axis. It turns on when an error occurred. Operation will only work when there is no error. If you want to operate a system regardless of errors, you can just inactivate the function.

(f) Servo On signal

When applying the example program of "8.1.2 Current State Read", this is "Servo On" signal for each axis. When each axis is Servo On state, it will be on. Since "Jog operation" command can't be executed when the axis is not servo on, it makes command executed when servo driver is "Servo On" state. If you execute "Jog operation" command when axis is not Servo On state, the error 413 occurs.

(g) Jog Operation Command for each axis

Jog Operation works by setting or clearing directly its considered bit from U device not by a command. In this example above, look at the axis 1, once Jog Operation conditions are satisfied, clockwise jog bit becomes "On," count clockwise jog bit becomes "Off," and jog speed bit becomes "On." Everything together Jog Operation works clock wisely with high speed. Reference for detail information about Bit of U device is from "Chapter 5.2.1."

The value of U device renewed from Scan End of sequence program.

(3) Inching Operation

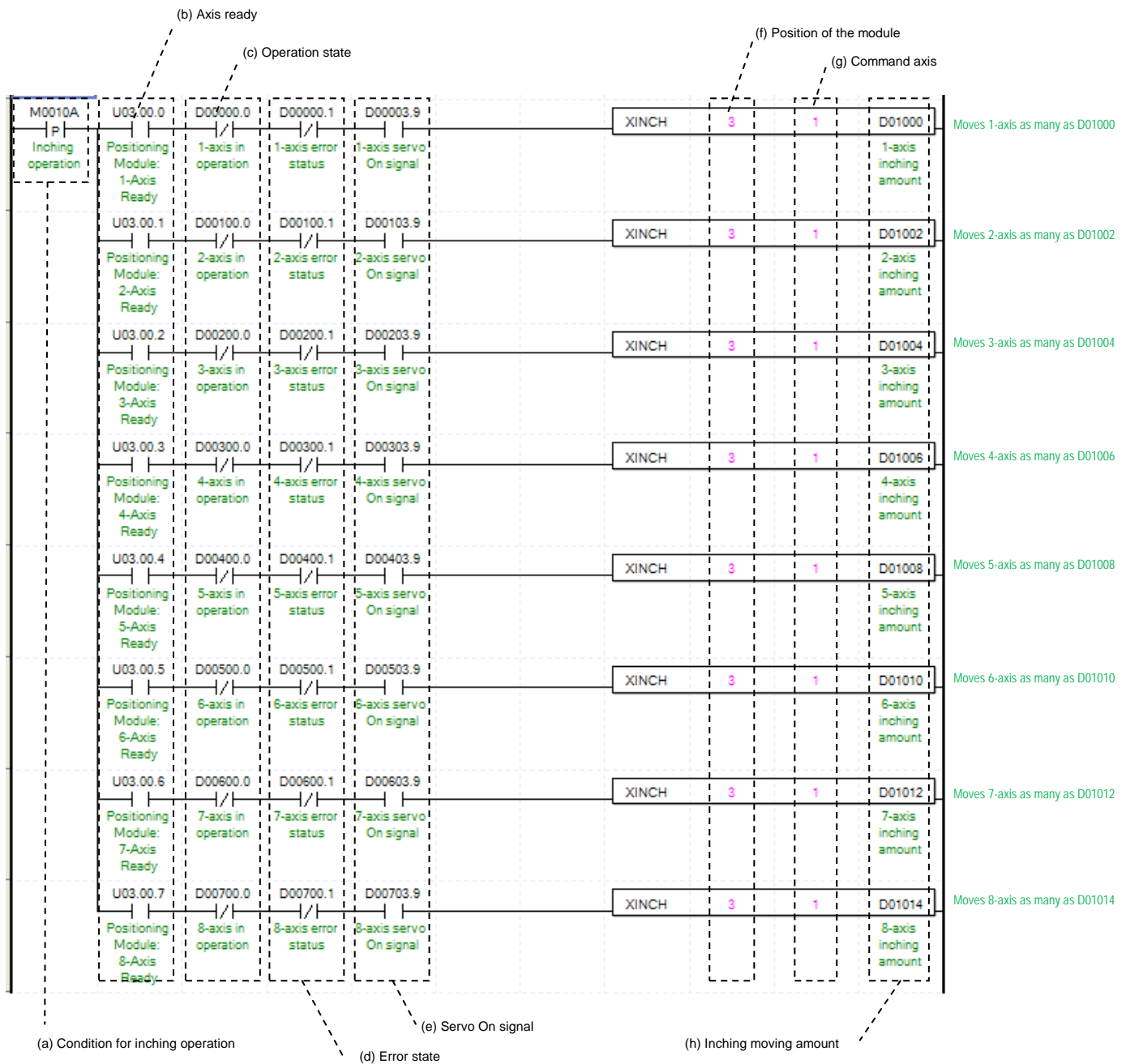

(a) Condition of Inching Operation
 Condition of Inching Operation Command (XINCH)

(b) Axis Ready

If communication between the positioning module and the servo driver is normal, the signal corresponding to each axis will be on.

(c) Operating state by axis

According to exercise from "Chapter 8.1.2 Current State Reading," it is a signal of "Inching Operating" for each axis. It turns on when it is operating. Inching Operation can not be configured while it is running hence configuration will only be configured when it is not running. If you execute Inching Operation while it is running, the "error 401" would be appeared.

(d) Error state for each axis

According to exercise from “Chapter 8.1.2 Current State Reading,” it is a signal of “Error state” for each axis. It turns on when an error occurred. Operation will only work when there is no error. If you want to operate a system regardless of errors, you can just inactivate the function.

(e) Servo On signal

When applying the example program of “8.1.2 Current State Read”, this is “Servo On” signal for each axis. When each axis is Servo On state, it will be on. Since “Inching operation” command can’t be executed when the axis is not servo on, it makes command executed when servo driver is “Servo On” state. If you execute “Inching operation” command when axis is not Servo On state, the error 403 occurs.

(f) Address of Positioning Module

In this example, Positioning Module installed at the slot no.3 of 0 bases.

(g) Axis of command execution

You can set an axis for Inching Operation. XBF-PN04(8)B can supports for 4(8) axes. In the “execution of axis” from the configuration of Inching Operation, you can set a value for axis 1 through 4(8) axis.

(h) Amount of Inching Operation Movement

Measure the amount of moving range by Inching Operation.

(i) Reference for Inching Operation is from “Chapter 9.3.2.”

(4) Return to the position before Manual Operation

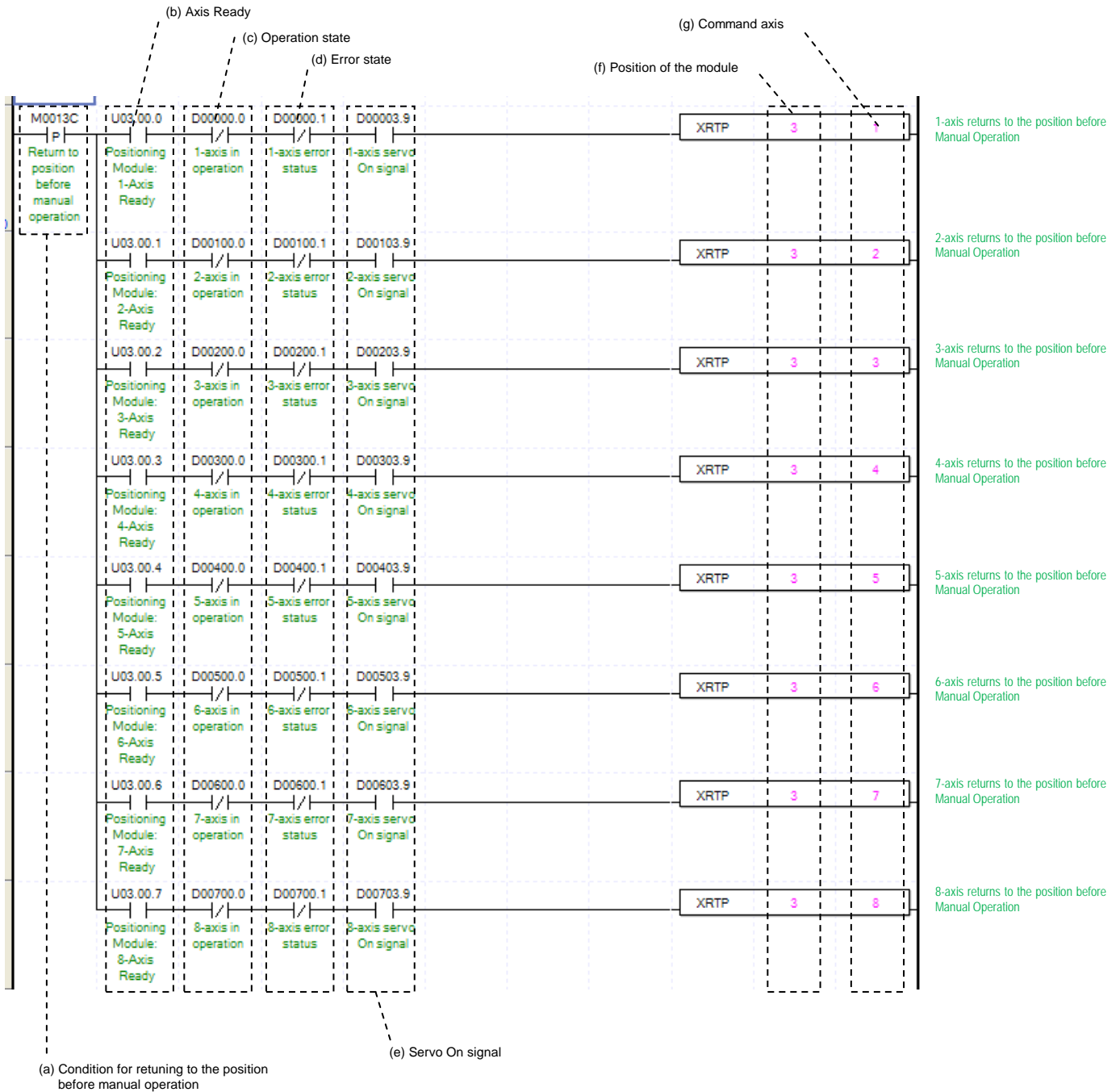

- (a) Condition of Return to the position before Manual Operation
Condition of Return to the position before Manual Operation Command (XRTP)
- (b) Axis Ready
If communication between the positioning module and the servo driver is normal, the signal corresponding to each axis will be on.
- (c) Operating state by axis
According to exercise from "Chapter 8.1.2 Current State Reading," it is a signal of "Manual Operating" for each axis. It turns on when it is operating. Inching Operation can not be configured while it is running hence configuration will only be configured when it is not running. If you execute Manual Operation while it is running, the "error 431" would be appeared.

(d) Error state for each axis

According to exercise from “Chapter 8.1.2 Current State Reading,” it is a signal of “Error state” for each axis. It turns on when an error occurred. Operation will only work when there is no error. If you want to operate a system regardless of errors, you can just inactivate the function.

(e) Servo On signal

When applying the example program of “8.1.2 Current State Read”, this is “Servo On” signal for each axis. When each axis is Servo On state, it will be on. Since “Return to the manual operation” command can’t be executed when the axis is not servo on, it makes command executed when servo driver is “Servo On” state. If you execute “Return to the manual operation” command when axis is not Servo On state, the error 434 occurs.

(f) Address of Positioning Module

In this example, Positioning Module installed at the slot no.3 of 0 bases.

(g) Axis of command execution

You can set an axis for Manual Operation. XBF-PN04(8)B can supports for 4(8) axes. In the “execution of axis” from the configuration of Manual Operation, you can set a value for axis 1 through 4(8) axis.

(h) When manual operation is running, the other operations are going back to its original position such as Jog Operation and Inching Operation. Reference for Manual Operation is from “Chapter 9.3.2.”

8.1.5 Parameter and Operation Data Setting

(1) Parameter Setting

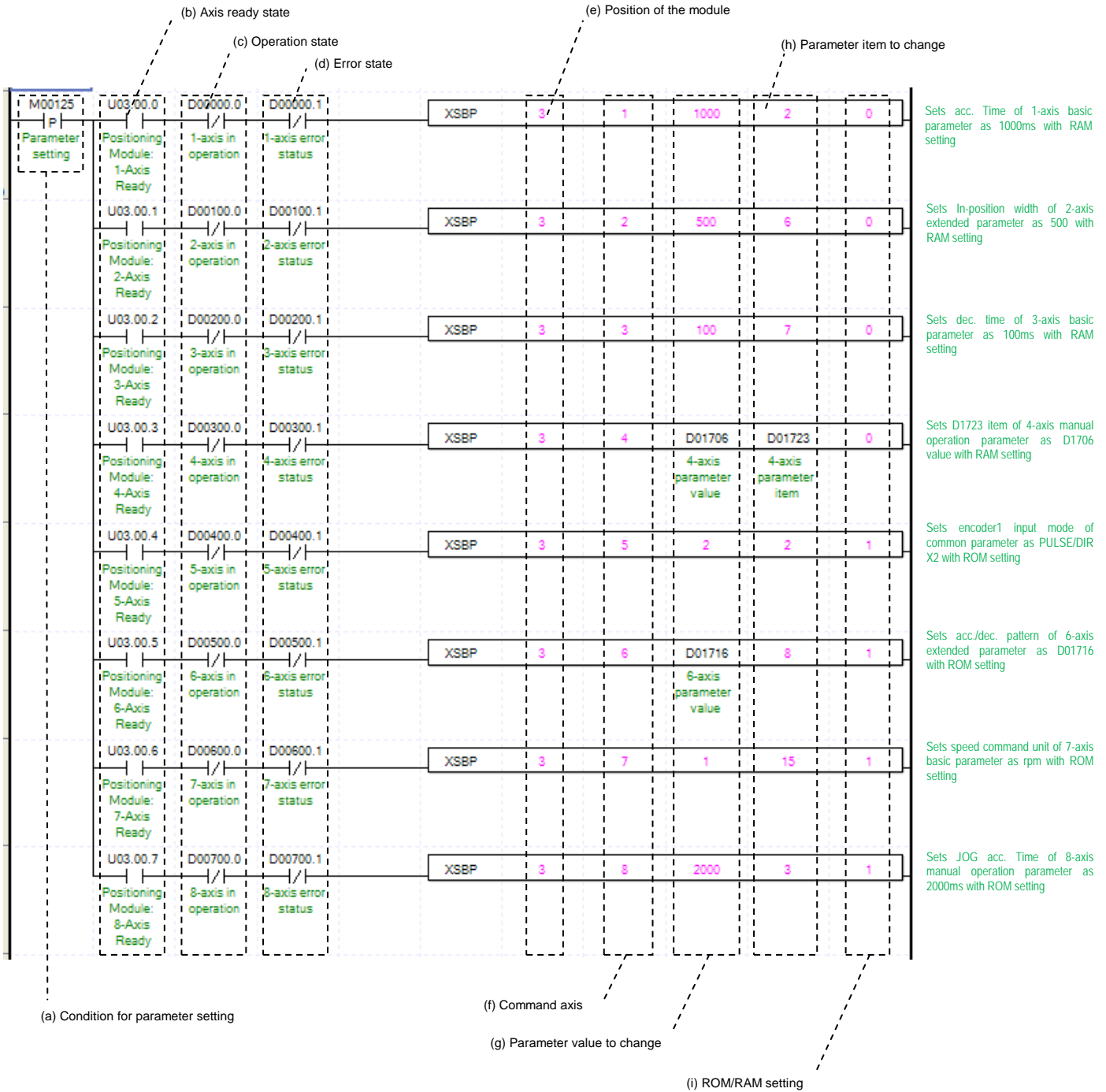

- (a) Condition of Parameter Setting Command
Condition of Parameter Setting Command (XSEP, XSHP, XSMP, XSES, XSCP)
- (b) Axis ready state
If communication between the positioning module and the servo driver is normal, the signal corresponding to each axis will be on.
- (c) Operating state by axis
According to exercise from "Chapter 8.1.2 Current State Reading," it is a signal of "Operating" for each axis. It turns on when it is operating. Except common parameter setting, parameter setting can not be configured while it is running hence configuration will only be configured when it is not running. If you execute Parameter Setting while it is running, the "error 471" would be appeared.
- (d) Error state for each axis
According to exercise from "Chapter 8.1.2 Current State Reading," it is a signal of "Error state" for each axis. It turns on when an error occurred. Operation will only work when there is no error. If you want to operate a system regardless of errors, you can just inactivate the function.
- (e) Address of Positioning Module
In this example, Positioning Module installed at the slot no.3 of 0 bases.
- (f) Axis of command execution
You can set an axis for Parameter Setting. XBF-PN04(8)B can supports for 4(8) axes. In the "execution of axis" from the configuration of Parameter Setting, you can set a value for axis 1 through 4(8) axis.
- (g) Value of Changing Parameter
You can set a value of changing parameter. For more information about Parameter Value Changing look for "Chapter 6. Command." In case of setting I/O parameter, the value would be parameter value itself.
- (h) List of Changing Parameter
You need to set a list for parameter (f) changing from set command. Once operating is working, this value will change to parameter (f). For more information of list of changing parameter look for "Chapter 6. Command." In case of setting I/O parameter, the value would be parameter value itself. Therefore changing of list would not be necessary.
- (i) ROM/RAM Setting
This function sets whether you save value of changing parameter to Rom or Ram. If you choose Rom the data will be saved regardless of power and if you save in the ram the data will be vanished when powers off. This parameter sets as 1 means Rom saved, and sets as 0 means Ram saved. There is no limitation of saving parameters in the Rom since parameter of Positioning Module saved in the MRAM.

(2) Operating Data Setting

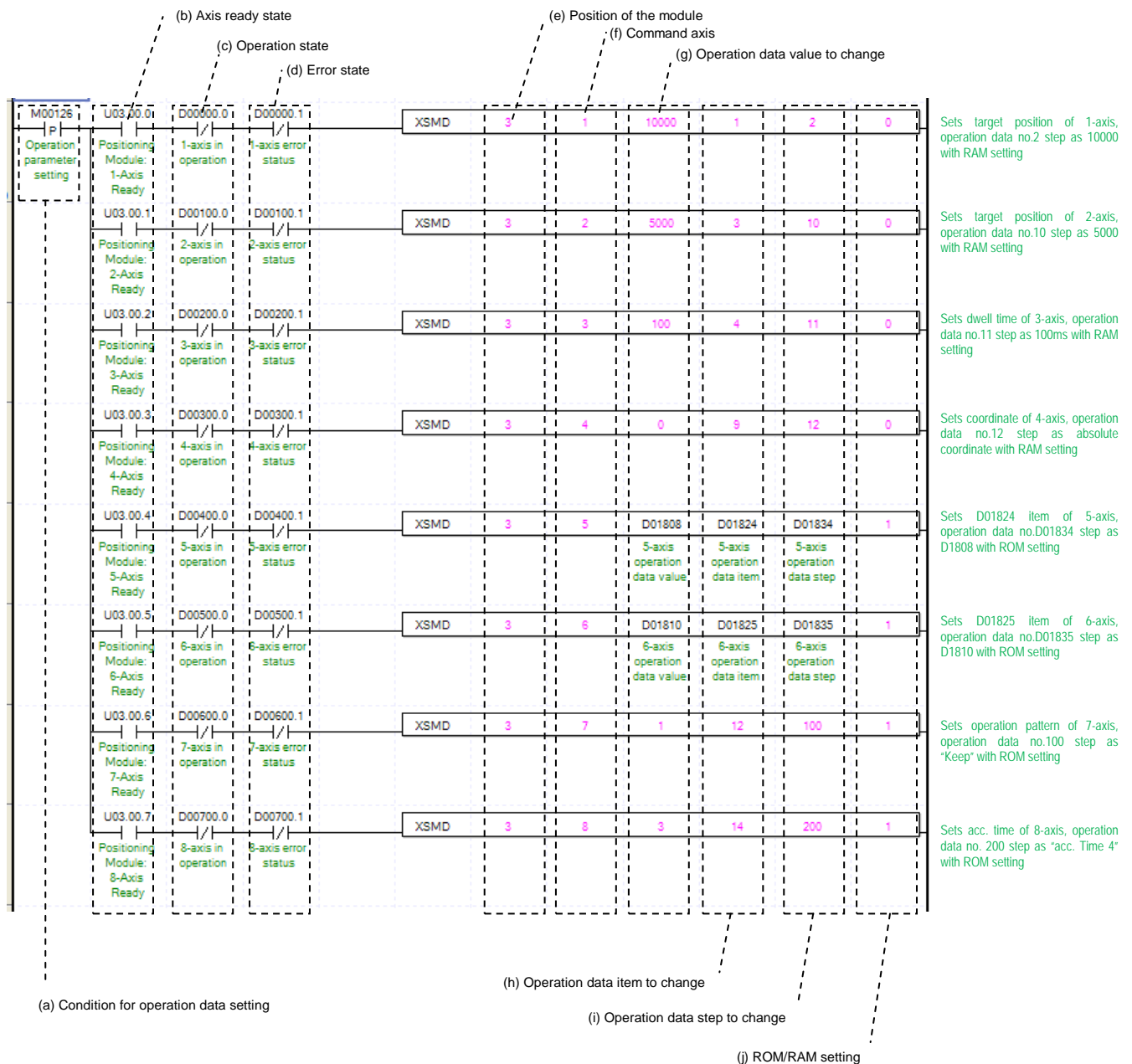

(a) Condition of Operating Data Command
Condition of Operating Data Command (XSMMD)

(b) Axis ready state

If communication between the positioning module and the servo driver is normal, the signal corresponding to each axis will be on.

(c) Operating state by axis

According to exercise from "Chapter 8.1.2 Current State Reading," it is a signal of "Operating" for each axis. It turns on when it is operating. Operating Data Setting can not be configured while it is running hence configuration will only be configured when it is not running. Operation data setting command is available to be executed when the axis is operating. However, if operation data of the step that is currently operated are changed, those changes are reflected after the current step is completed.

(d) Error state for each axis

According to exercise from “Chapter 8.1.2 Current State Reading,” it is a signal of “Error state” for each axis. It turns on when an error occurred. Operation will only work when there is no error. If you want to operate a system regardless of errors, you can just inactivate the function.

(e) Address of Positioning Module

In this example, Positioning Module installed at the slot no.3 of 0 bases.

(f) Axis of command execution

You can set an axis for Operating Data Setting. XBF-PN04(8)B can supports for 4(8) axes. In the “execution of axis” from the configuration of Operating Data Setting, you can set a value for axis 1 through 4(8) axis.

(g) Value of Changing Parameter

You can set a value of changing parameter.

(h) List of Changing Parameter

You need to set a list for parameter (f) changing from set command. Once operating is working, this value will change to parameter (f). Each value of Operating Data is listed below. For example if you put 1000 for value of Changing Operating Data and 4 for Operating data then the value of Dwell is going to be set as 1000ms.

Setting Value	Items
1	Goal Position
2	Circular interpolation auxiliary position
3	Operating speed
4	Dwell Time
5	M code No.
6	Auxiliary axis setting
7	Helical interpolation axis
8	The number of circular interpolation turn
9	Coordinates
10	Control method
11	Operating method
12	Operating pattern
13	Size of Circular arc
14	Acc. No.
15	Dec. No.
16	Circular interpolation method
17	Circular interpolation direction

(i) Changing Operating Data Step

You can configure the changing operating data step number by using the operating data step command. XBF-PN04B/PN08B can support 400 steps for each axis. This value supports from number 0 to 400. The numbers are considered as a step meaning number 1~400 are same as 1~400 steps. When you set this value as 0 means that you will stay put with current value.

(j) ROM/RAM Setting

This function sets whether you save value of changing parameter to Rom or Ram. If you choose Rom the data will be saved regardless of power and if you save in the ram the data will be vanished when powers off. This parameter sets as 1 means Rom saved, and sets as 0 means Ram saved. There is no limitation of saving parameters in the Rom since parameter of Positioning Module saved in the MRAM.

(3) Operation Data Multiple Teaching

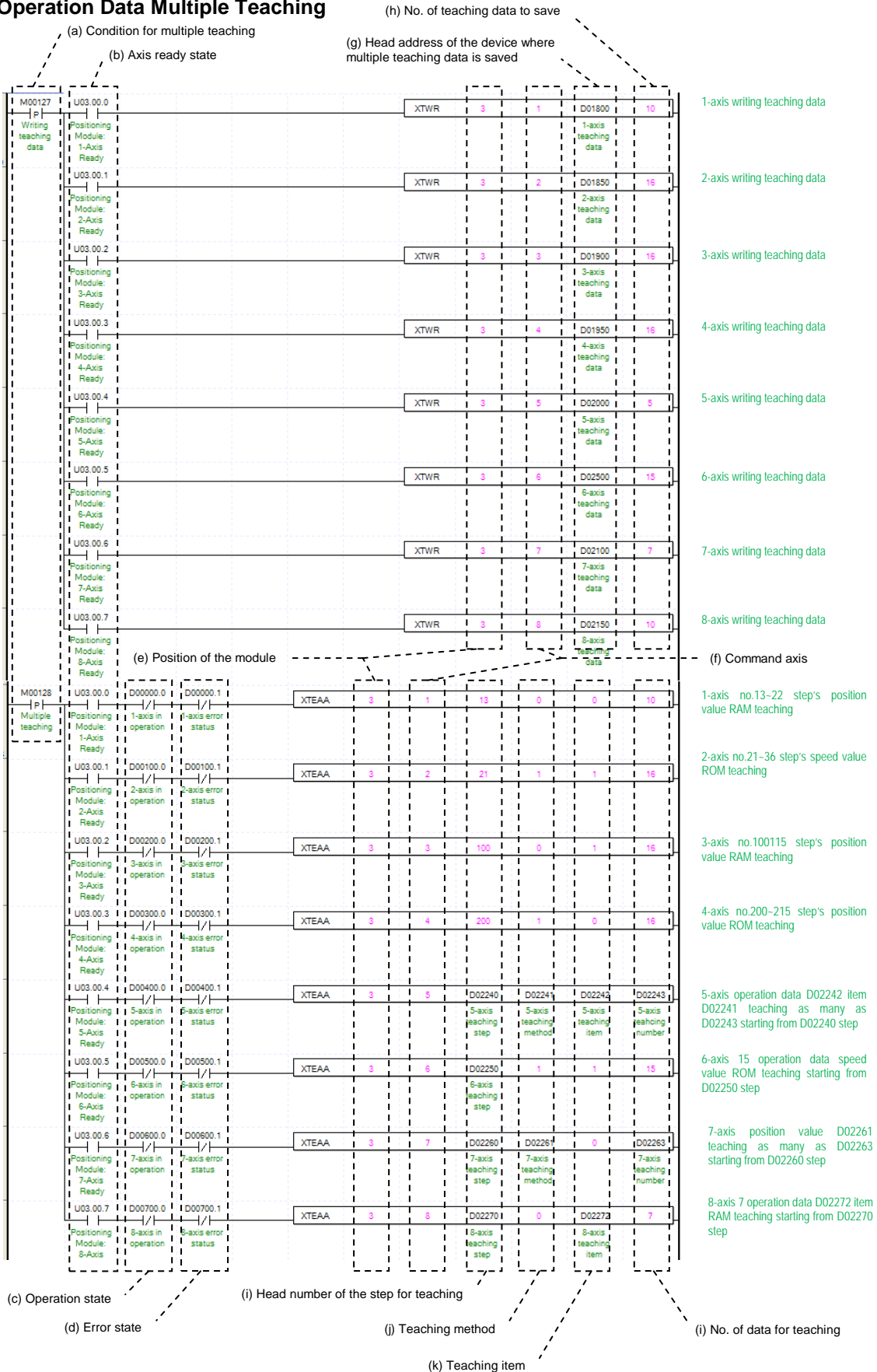

(a) Condition of Teaching Array

Condition Teaching Array Command (XTWR, XTEAA)

(b) Axis ready state

If communication between the positioning module and the servo driver is normal, the signal corresponding to each axis will be on.

(c) Operating state by axis

According to exercise from “Chapter 8.1.2 Current State Reading,” it is a signal of “Operating” for each axis. It turns on when it is operating. Teaching Array can not be configured while it is running hence configuration will only be configured when it is not running. Even though teaching array can be performed even when the axis subject to teaching is being operated but, only the current step’s data is reflected after the current step operation is completed if the step that is currently running is within the step area while other steps’ data are immediately changed.

(d) Error state for each axis

According to exercise from “Chapter 8.1.2 Current State Reading,” it is a signal of “Error state” for each axis. It turns on when an error occurred. Operation will only work when there is no error. If you want to operate a system regardless of errors, you can just inactivate the function.

(e) Address of Positioning Module

In this example, Positioning Module installed at the slot no.3 of 0 bases.

(f) Axis of command execution

You can set an axis for Teaching Array. XBF-PN04(8)B series supports for 4(8) axes. In the “execution of axis” from the configuration of Teaching Array, you can set a value for axis 1 through 4(8) axis.

(g) Address of first device where those data for Teaching Array are saved

To execute a Teaching Array, you need to set a specific value first. TWR commands are using for set up those Teaching Array data. It has to be done before actual Teaching Array operation. Teaching Data will be set up depends on number of first device as below table.

No.	Device No.	Teaching array data
1	Device + 0	Teaching array data1
2	Device + 2	Teaching array data2
3	Device + 4	Teaching array data3
4	Device + 6	Teaching array data4
5	Device + 8	Teaching array data5
6	Device + 10	Teaching array data6
7	Device + 12	Teaching array data7
8	Device + 14	Teaching array data8
9	Device + 16	Teaching array data9
10	Device + 18	Teaching array data10
11	Device + 20	Teaching array data11
12	Device + 22	Teaching array data12
13	Device + 24	Teaching array data13
14	Device + 26	Teaching array data14
15	Device + 28	Teaching array data15
16	Device + 30	Teaching array data16

(h) Amount of Saving Teaching data

Decide how many data will be saved by using XTWR command. Maximum 16 data can be saved. In this example above, 10 Teaching data saved in the axis 1. Therefore those Teaching data from D01800~D01818 saved in the module.

(i) First number of Teaching Step

You can setup the first number of Teaching Step among the Operating Data step. In this example above, Teaching Array of axis 1 will be operate from 22th step, which is 10th step away from 13th step, hence it will be operate between 13th step and 22th step.

(j) Teaching Method

This function sets whether you save value of changed Teaching data to Rom or Ram. If you choose Rom the data will be saved regardless of power and if you save in the ram the data will be vanished when powers off. This parameter sets as 1 means Rom saved, and sets as 0 means Ram saved. There is no limitation of saving parameters in the Rom since parameter of Positioning Module saved in the MRAM.

(k) List of Teaching

You can set a data with Teaching Method among the Operating Data. Both “Goal Position” and “Operating Speed” can be changed by Teaching Array. When its value set “0” means set a Goal Position and “1” means set an Operating Speed.

(l) Amount of Teaching Method

Decide how many steps will be operated using by Teaching Method. Maximum 16 Teaching Array data can be used. For more information about Teaching Array Operation, look for reference from “Chapter 9.7.1”

(m) This example above can also be operated, using command PUT from XTWR as below.

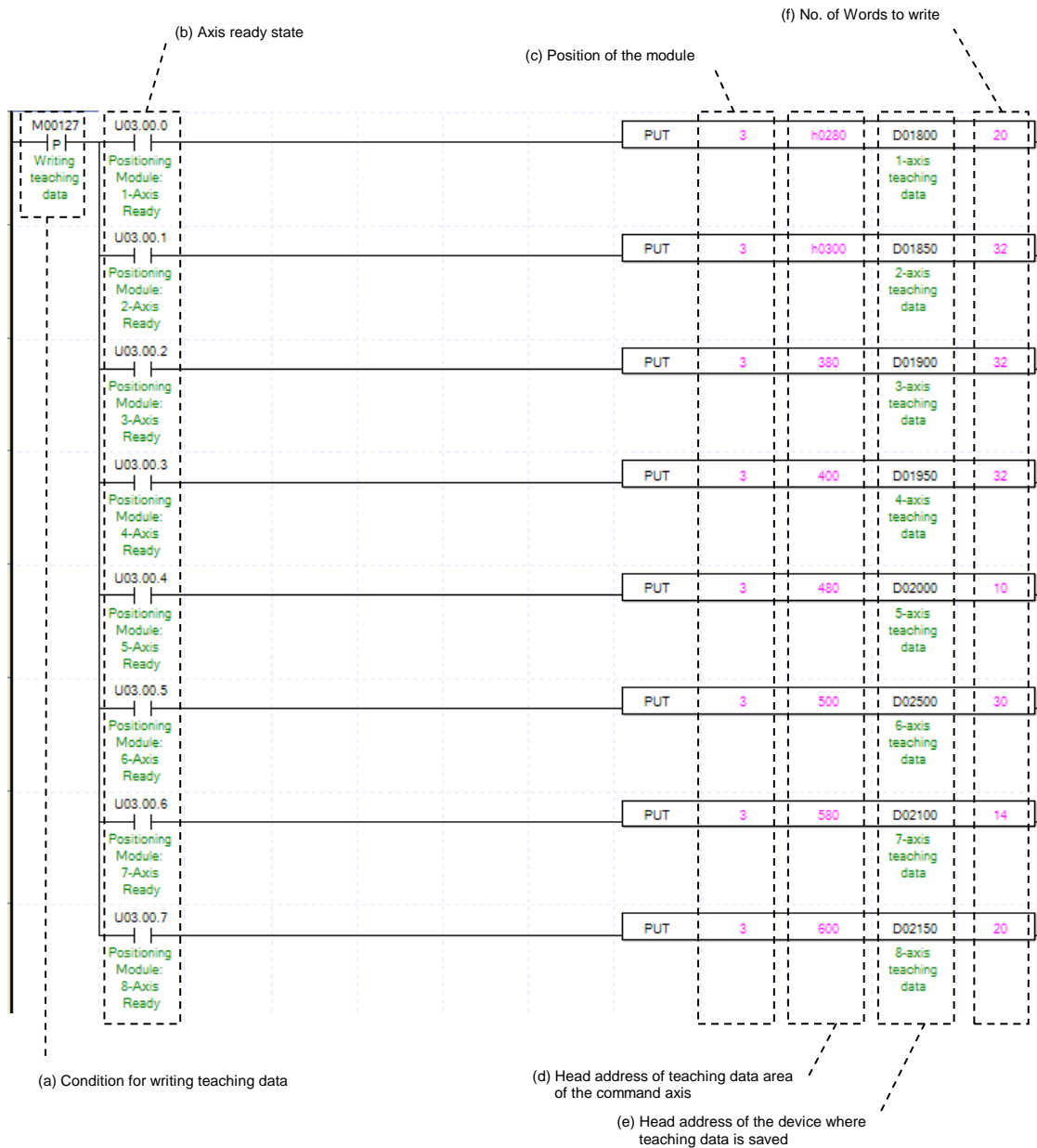

For more information about each saving Teaching Data, look for reference from “Chapter 5.1.2.” When you are using a command “PUT,” you need to setup a type of data as a “WORD” not a “DINT” considered its size.

(4) Saving Current Data

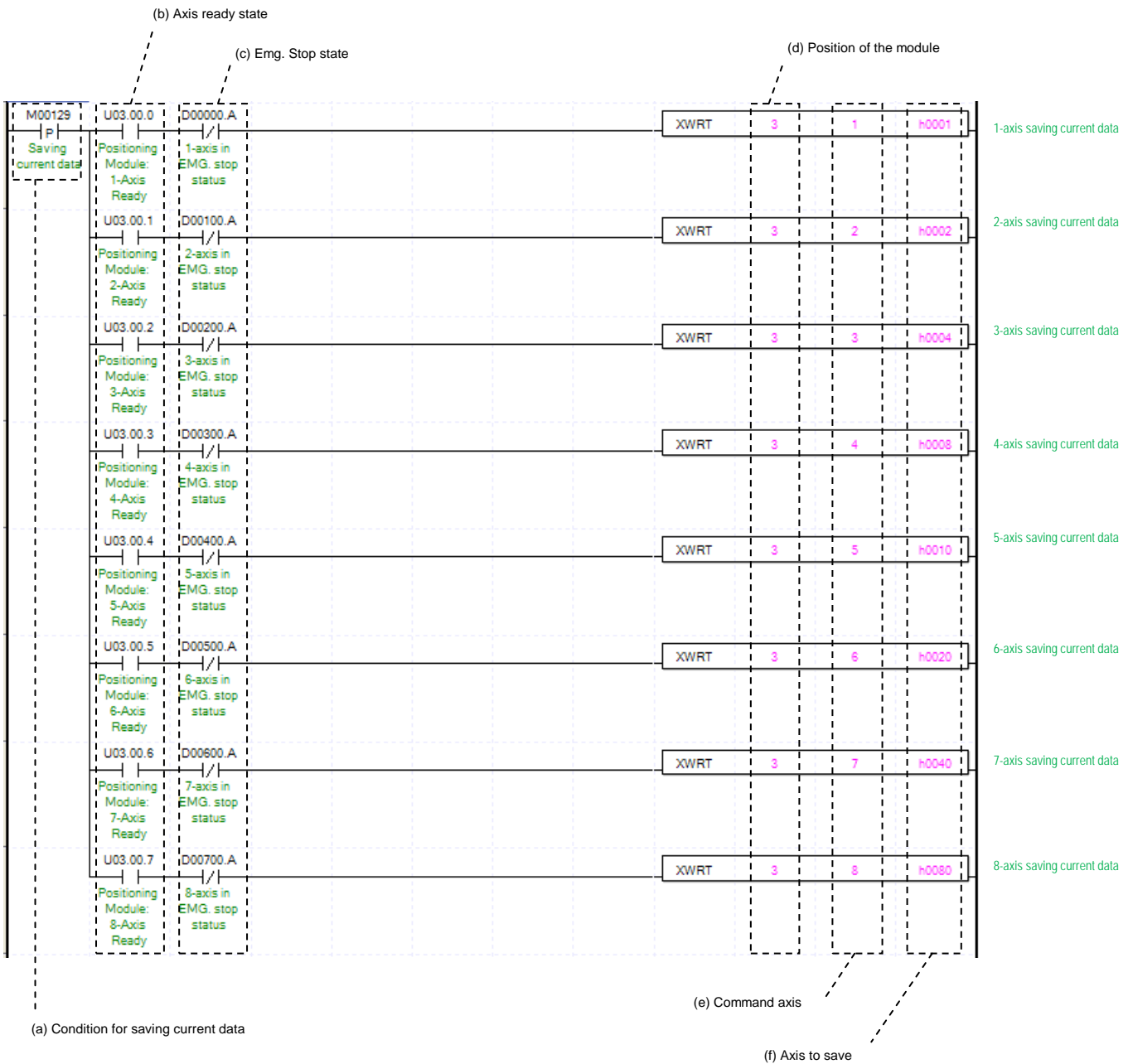

- (a) Condition of Saving Current Data
Condition of Saving Current Data Command (XWRT). When current saving data operated, those values of module parameter and operating data would be saved in MRAM. Therefore configuration of Ram or Ram Teaching would be constantly saved whether power is on or not.
- (b) Axis ready state
If communication between the positioning module and the servo driver is normal, the signal corresponding to each axis will be on.
- (c) Emergency Stop by each axis
According to exercise from "Chapter 8.1.2 Current State Reading," it is a signal of "State of Emergency Stop" for each axis. It turns on when it is Emergency Stop. Emergency Stop can not be configured while it is running hence configuration will only be configured when it is not running.
- (d) Address of Positioning Module
In this example, Positioning Module installed at the slot no.3 of 0 bases.

(e) Axis of command execution

You can set an axis for Saving Current Data. XBF-PN04(8)B can supports for 4(8) axes. In the “execution of axis” from the configuration of Saving Current Data, you can set a value for axis 1 through 4(8) axis.

(f) Saving by axis

Configure current data operation setting. Choosing axis are configured follow by below table. Therefore even if those axis are not operated as it programmed, saving axis can be saved in Array. The data of operated axis saved in MRAM, which make constantly stable whether its power is on or not.

15 ~ 8 Bit	7Bit	6Bit	5Bit	4Bit	3Bit	2Bit	1Bit	0Bit
N/A	8-axis	7-axis	6-axis	5-axis	4-axis	3-axis	2-axis	1-axis

8.1.6 Positioning Operation

(1) Homing

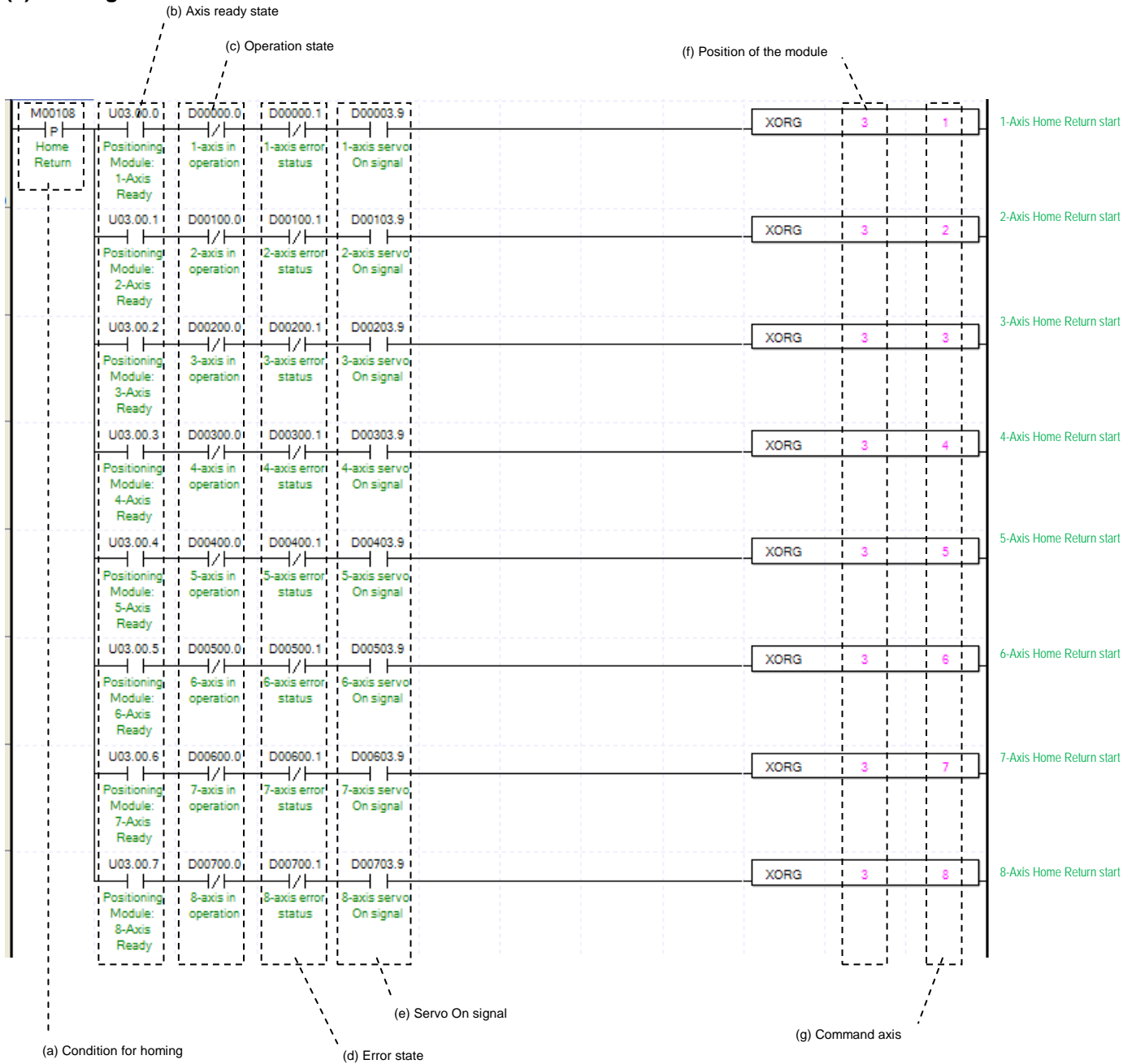

(a) Condition of Homing
Condition of Homing Command (XORG)

(b) Axis ready state
If communication between the positioning module and the servo driver is normal, the signal corresponding to each axis will be on.

(c) Operating state by axis
According to exercise from “Chapter 8.1.2 Current State Reading,” it is a signal of “Operating” for each axis. It turns on when it is operating. Homing command can not be configured while it is running hence configuration will only be configured when it is not running. If you execute Homing while it is running, the “error 201” would be appeared.

(d) Error state for each axis

According to exercise from “Chapter 8.1.2 Current State Reading,” it is a signal of “Error state” for each axis. It turns on when an error occurred. Operation will only work when there is no error. If you want to operate a system regardless of errors, you can just inactivate the function.

(e) Servo On signal

When applying the example program of “8.1.2 Current State Read”, this is “Servo On” signal for each axis. When each axis is Servo On state, it will be on. Since “Homing” command can’t be executed when the axis is not servo on, it makes command executed when servo driver is “Servo On” state. If you execute “Homing” command when axis is not Servo On state, the error 203 occurs.

(f) Address of Positioning Module

In this example, Positioning Module installed at the slot no.3 of 0 bases.

(g) Axis of command execution

You can set an axis for Homming Operation. XBF-PN04(8)B can supports for 4(8) axes. In the “execution of axis” from the configuration of Homming Operation, you can set a value for axis 1 through 4(8) axis.

(h) For more information, reference for Homing is in the “Chapter 9.1.”

(2) Direct Start

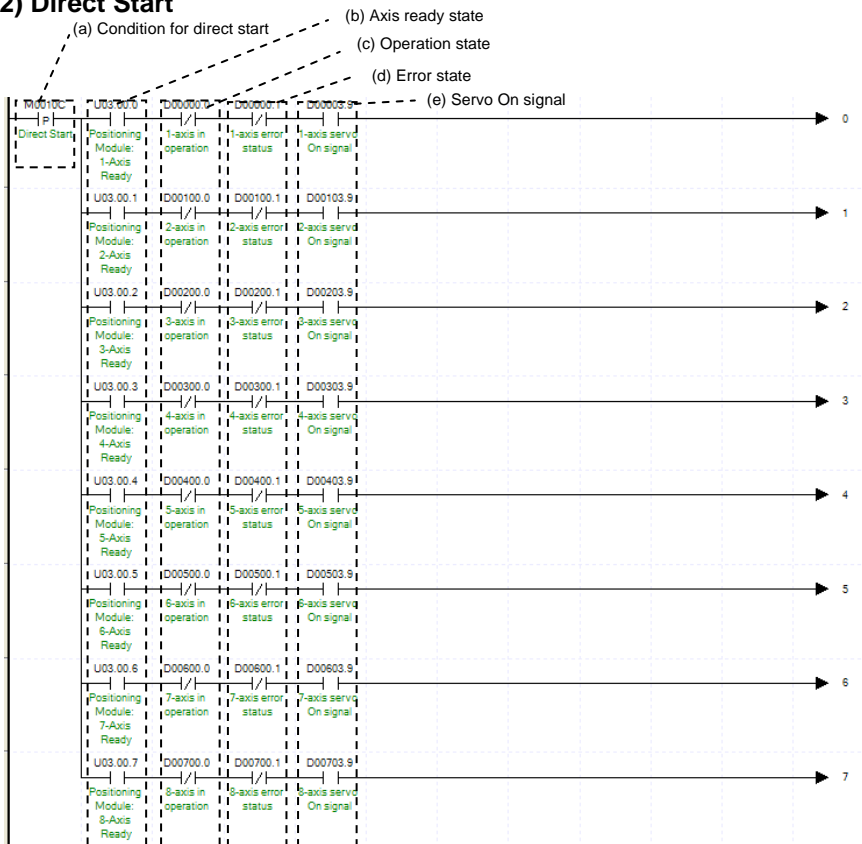

Module	Position of the module	Command axis	Direct start target position	Direct start target speed	Direct start dwell time	Direct start control word	Direct start M code
0	XDST	3	1	D01100	D01200	0	0
1	XDST	3	2	D01102	D01202	0	h0511
2	XDST	3	3	D01104	D01204	100	h0A02
3	XDST	3	4	D01106	D01206	0	123
4	XDST	3	5	D01108	D01208	500	10
5	XDST	3	6	D01110	D01210	0	0
6	XDST	3	7	D01112	D01212	0	0
7	XDST	3	8	D01114	D01214	0	0

1-axis, target position D01100, target speed D01200, dwell time 0, M code 0, absolute coordinate, acc. time 1, dec. time 1, position control

2-axis, target position D01102, target speed D01202, dwell time 0, M code 0, incremental coordinate, acc. time 2, dec. time 2, speed control

3-axis, target position D01104, target speed D01204, dwell time 0, M code 0, absolute coordinate, acc. time 3, dec. time 3, Feed control

4-axis, target position D01106, target speed D01206, dwell time 0, M code 123, incremental coordinate, acc. time 4, dec. time 4, position control

5-axis, target position D01108, target speed D01208, dwell time 500ms, M code 10, incremental coordinate, acc. time 1, dec. time 1, speed control

6-axis, target position D01110, target speed D01210, dwell time 0, M code 0, absolute coordinate, acc. time 1, dec. time 4, position control

7-axis, target position D01112, target speed D01212, dwell time 0, M code 0, incremental coordinate, acc. time 4, dec. time 1, speed control

8-axis, target position D01114, target speed D01214, dwell time 0, M code 0, incremental coordinate, acc. time 2, dec. time 3, Feed control

(f) Position of the module
 (g) Command axis
 (h) Direct start target position
 (i) Direct start target speed
 (j) Direct start dwell time
 (k) Direct start M code

- (a) Condition of Direct Start
Condition of Direct Start Command (XDST)
- (b) Axis ready state
If communication between the positioning module and the servo driver is normal, the signal corresponding to each axis will be on.
- (c) Operating state by axis
According to exercise from "Chapter 8.1.2 Current State Reading," it is a signal of "Operating" for each axis. It turns on when it is operating. Direct Start command can not be configured while it is running hence configuration will only be configured when it is not running. If you execute Direct Start while it is running, the "error 221" would be appeared.
- (d) Error state for each axis
According to exercise from "Chapter 8.1.2 Current State Reading," it is a signal of "Error state" for each axis. It turns on when an error occurred. Operation will only work when there is no error. If you want to operate a system regardless of errors, you can just inactivate the function.
- (e) Servo On signal
When applying the example program of "8.1.2 Current State Read", this is "Servo On" signal for each axis. When each axis is Servo On state, it will be on. Since "Direct start" command can't be executed when the axis is not servo on, it makes command executed when servo driver is "Servo On" state. If you execute "Direct start" command when axis is not Servo On state, the error 225 occurs
- (f) Address of Positioning Module
In this example, Positioning Module installed at the slot no.3 of 0 bases.
- (g) Axis of command execution
You can set an axis for Direct Start. XBF-PN04(8)B series supports for 4(8) axes. In the "execution of axis" from the configuration of Direct Start, you can set a value for axis 1 through 4(8) axis.
- (h) Goal of Direct Start
Decide changing position of Direct Start command. In this example above, the initialized value is "device," but you can also change it with "real numbers," which data type is "DINT."
- (i) Speed of Direct Start
Decide goal speed of Direct Start. In this example above, the initialized value is "device," but you can also change it with "real numbers," which data type is "UDINT."
- (j) Dwell Time of Direct Start
Dwell Time consider as a total amount of time from beginning of Direct Start operation that reach to the goal position and make output of Positioning Done Signal. That means after done its operation, direct Start will make a Positioning done signal. Its unit is "ms," and type is "UINT"
- (k) Direct Start M code
You can set a value of M code which are displaying of Operating Parameter by Direct Start. The way of M code outputs are "Parameter Expansion, M code Mode," within the "None, With, After." It will make an M code besides you choose "None" for its parameter. For more information, reference for M code is in the "Chapter 4.2.2"
- (l) Direct Start Control Word
These are list of setting values in a form of Word by Bit for Direct Start. The details of Bits are in the table below.

15 ~ 12	11 ~ 10	9 ~ 8	7 ~ 5	4	3 ~ 2	1 ~ 0
-	Dec. Time	Acc. Time	-	0:Absolute 1: Incremental	-	0:Position control 1:Speed control 2:Feed control 3: Shortest position control

(3) Indirect Start

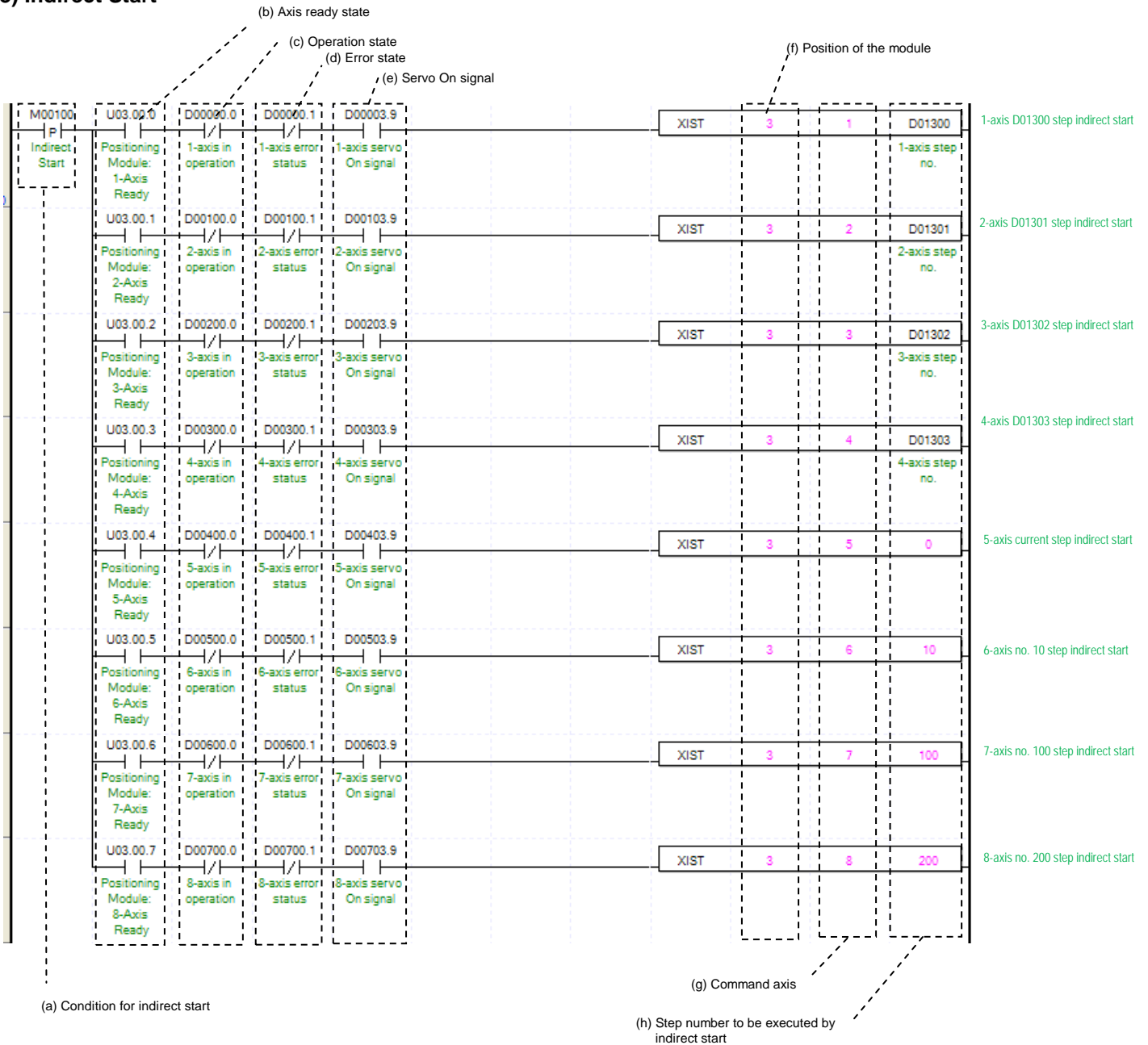

(a) Condition of Indirect Start
Condition of Indirect Start Command (XIST)

(b) Axis ready state
If communication between the positioning module and the servo driver is normal, the signal corresponding to each axis will be on.

(c) Operating state by axis
According to exercise from “Chapter 8.1.2 Current State Reading,” it is a signal of “Operating” for each axis. It turns on when it is operating. Operating Data Setting can not be configured while it is running hence configuration will only be configured when it is not running. If you execute Indirect Start while it is running, the “error 231” would be appeared.

- (d) Error state for each axis
According to exercise from “Chapter 8.1.2 Current State Reading,” it is a signal of “Error state” for each axis. It turns on when an error occurred. Operation will only work when there is no error. If you want to operate a system regardless of errors, you can just inactivate the function.
- (e) Servo On signal
When applying the example program of “8.1.2 Current State Read”, this is “Servo On” signal for each axis. When each axis is Servo On state, it will be on. Since “Indirect start” command can’t be executed when the axis is not servo on, it makes command executed when servo driver is “Servo On” state. If you execute “Indirect start” command when axis is not Servo On state, the error 235 occurs.
- (f) Address of Positioning Module
In this example, Positioning Module installed at the slot no.3 of 0 bases.
- (g) Axis of command execution
You can set an axis for Indirect Start. XBF-PN04(8)B can supports for 4(8) axes. In the “execution of axis” from the configuration of Indirect Start, you can set a value for axis 1 through 4(8) axis.
- (h) Operating step number by Indirect Start
Set the operating step number by indirect start for main command axis.
- (i) Indirect start operates by appointing step of position data for each axis. Therefore it could run those commands of Positioning control, Speed control, Feed control, Linear circular interpolation depends on setting of positioning data. For more information, reference for Setting of Operating Data is in the “Chapter4.7.”

(4) Ellipse Interpolation

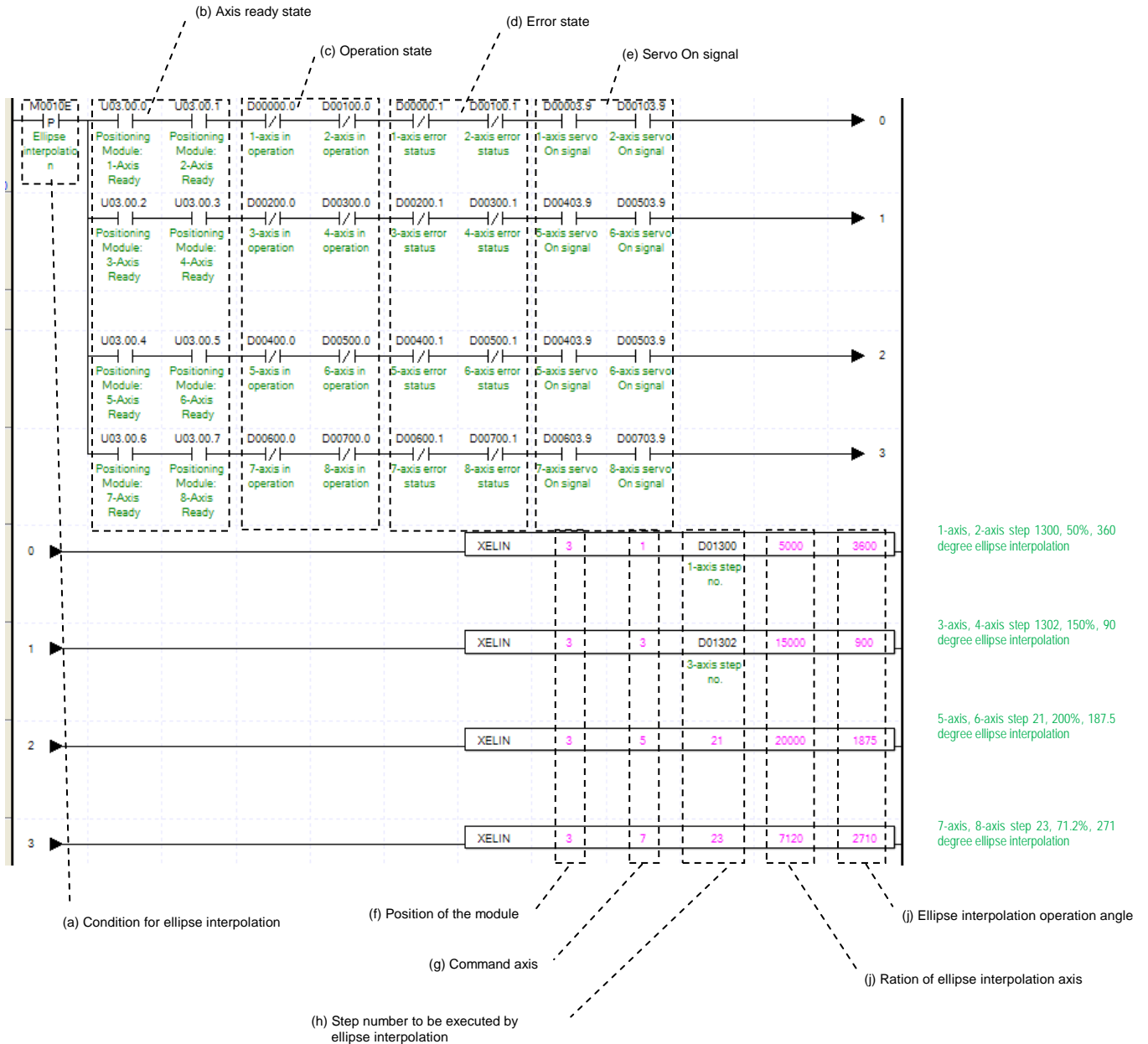

- (a) Condition of Ellipse Interpolation
Condition of Ellipse Interpolation Command (XELIN)
- (b) Operating state by axis
If communication between positioning module and servo drive is done, the signal corresponding to each signal will be on. Since ellipse interpolation operates two axis, main axis and sub axis have to be ready status.
- (c) Error state for each axis
According to exercise from “Chapter 8.1.2 Current State Reading,” it is a signal of “Error state” for each axis. It turns on when an error occurred. Operation will only work when there is no error. If you want to operate a system regardless of errors, you can just inactivate the function.
- (d) Ready signal for each axis
According to exercise from “Chapter 8.1.2 Current State Reading,” it is a signal of “Drive Ready” for each axis. This command only works when the condition of Drive Ready is on. If a Drive Ready of main axis is not set as “ON,” the “error 549” would be appeared and If a Drive Ready of subordinate axis is not set as “ON,” the “error 550” would be appeared and

(e) Servo On signal

When applying the example program of “8.1.2 Current State Read”, this is “Servo On” signal for each axis. When each axis is Servo On state, it will be on. Since “Indirect start” command can’t be executed when the axis is not servo on, it makes command executed when servo driver is “Servo On” state. If you execute “Indirect start” command when axis is not Servo On state, the error 235 occurs.

(f) Address of Positioning Module

In this example, Positioning Module installed at the slot no.3 of 0 bases.

(g) Axis of command execution

You can set an axis for Ellipse Interpolation. XBF-PN04(8)B can supports for 4(8) axes. In the “execution of axis” from the configuration of Ellipse Interpolation, you can set a value for axis 1 through 4(8) axis.

(h) Operating step number by Ellipse Interpolation

Set the operating step number by Ellipse Interpolation. The setting of main operating step and subordinate step is the same.

(i) Ratio of Ellipse Interpolation Axis

Set both ratio values for main and subordinate axis of set operates data from circular interpolation locus. It is to change circular locus into ellipse locus by using ratio of main and subordinate axis.

(j) Degree of Ellipse Interpolating Operation

Set the degree for Ellipse Interpolating Operation. Unit is [X10⁻¹ degree]. For more information, reference for Ellipse Interpolation is in the “Chapter9.213.”

(5) Simultaneous Start

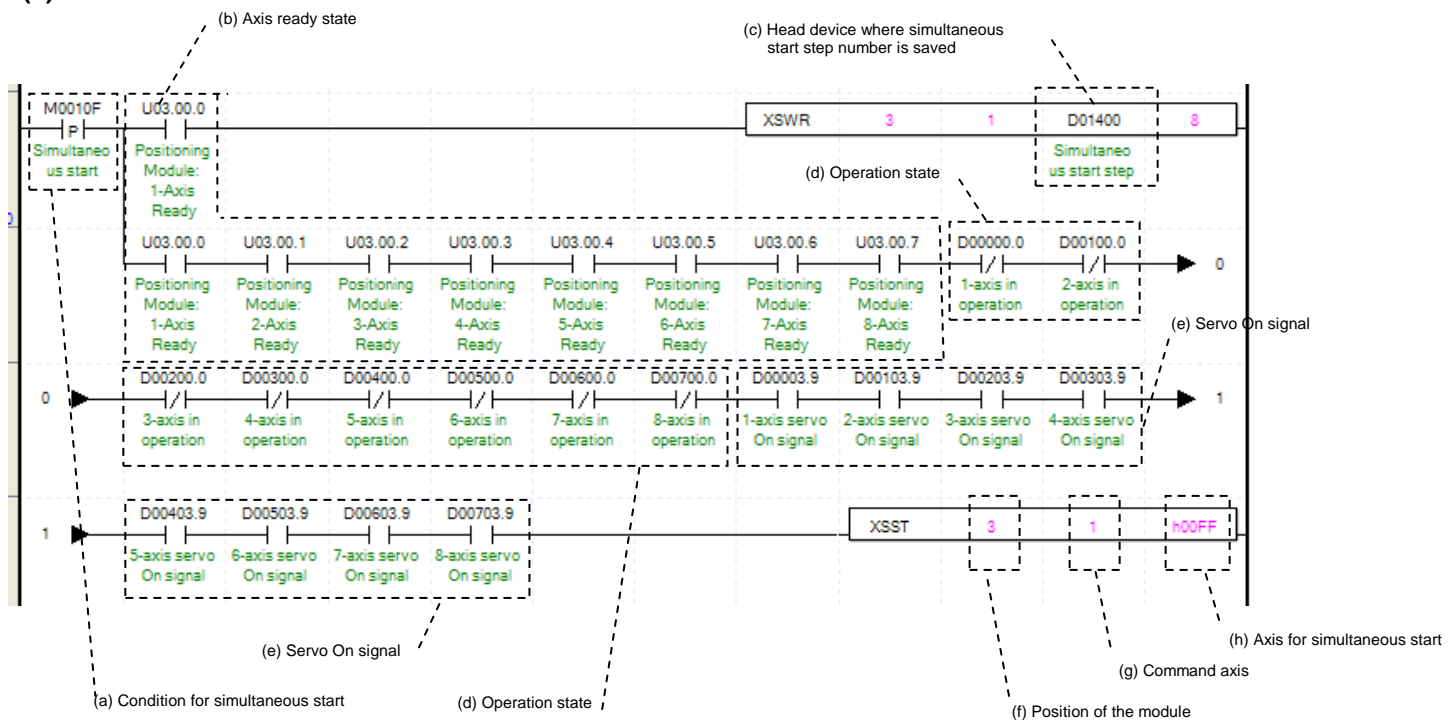

(a) Condition of Simultaneous Start

Condition of Simultaneous Start Command

(b) Axis ready state for each axis

If communication between positioning module and servo drive is done, the signal corresponding to each signal will be on. Since simultaneous start operates more than two axis simultaneously, all axis to operate have to be ready status.

(c) Address of first device where those step numbers for Simultaneous Start of each axis are saved

To execute a Simultaneous Start, set data steps for each axis. XSWR commands are using for set up those step data for Simultaneous Start. It has to be done before actual Simultaneous Start operation. Simultaneous Start will be set up depends on number of first device as below table.

Value	Device No.	Teaching Array Data
1	Device + 0	Axis1 Simultaneous Start Step
2	Device + 1	Axis2 Simultaneous Start Step
3	Device + 2	Axis3 Simultaneous Start Step
4	Device + 3	Axis4 Simultaneous Start Step
5	Device + 4	Axis5 Simultaneous Start Step
6	Device + 5	Axis6 Simultaneous Start Step
7	Device + 6	Axis7 Simultaneous Start Step
8	Device + 7	Axis8 Simultaneous Start Step

(d) Operating state by axis

According to exercise from “Chapter 8.1.2 Current State Reading,” it is a signal of “Operating” for each axis. It turns on when it is operating. Operating Data Setting can not be configured while it is running hence configuration will only be configured when it is not running. If you execute Axis1 Synchronous Start while it is running, the “error 291” would be appeared.

(e) Servo On signal

When applying the example program of “8.1.2 Current State Read”, this is “Servo On” signal for each axis. When each axis is Servo On state, it will be on. Since “Simultaneous start” command can’t be executed when the axis is not servo on, it makes command executed when servo driver is “Servo On” state. If you execute “Simultaneous start” command when axis is not Servo On state, the error 295 occurs.

(f) Address of Positioning Module

In this example, Positioning Module installed at the slot no.3 of 0 bases.

(g) Axis of command execution

You can set an axis for Simultaneous Start. XBF-PN04(8)B can supports for 4(8) axes. In the “execution of axis” from the configuration of Simultaneous Start, you can set a value for axis 1 through 4(8) axis.

(h) Axis for Simultaneous Start

Set axis for Simultaneous Start. The axis for Simultaneous Start uses a “bit” from WORD Data setting as a “1” for each axis. Axis for each bits are as below.

15 ~ 8 Bit	7Bit	6Bit	5Bit	4Bit	3Bit	2Bit	1Bit	0Bit
Not use	Axis8	Axis7	Axis6	Axis5	Axis4	Axis3	Axis2	Axis1

In the example program, since it is set as “hFF”, it operates axis1~axis8, all axis simultaneously.

(i) In this program above, you can use command “PUT” instead of XSWR.

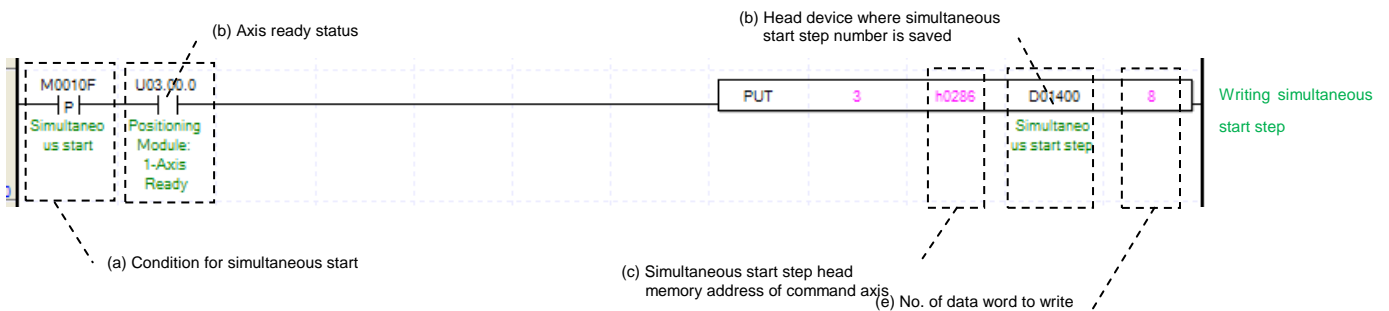

(j) Setting a memory address for each axis of Simultaneous Start step number, look up reference for Simultaneous Start is in the “Chapter5.1.3.”

(6) Point Operation

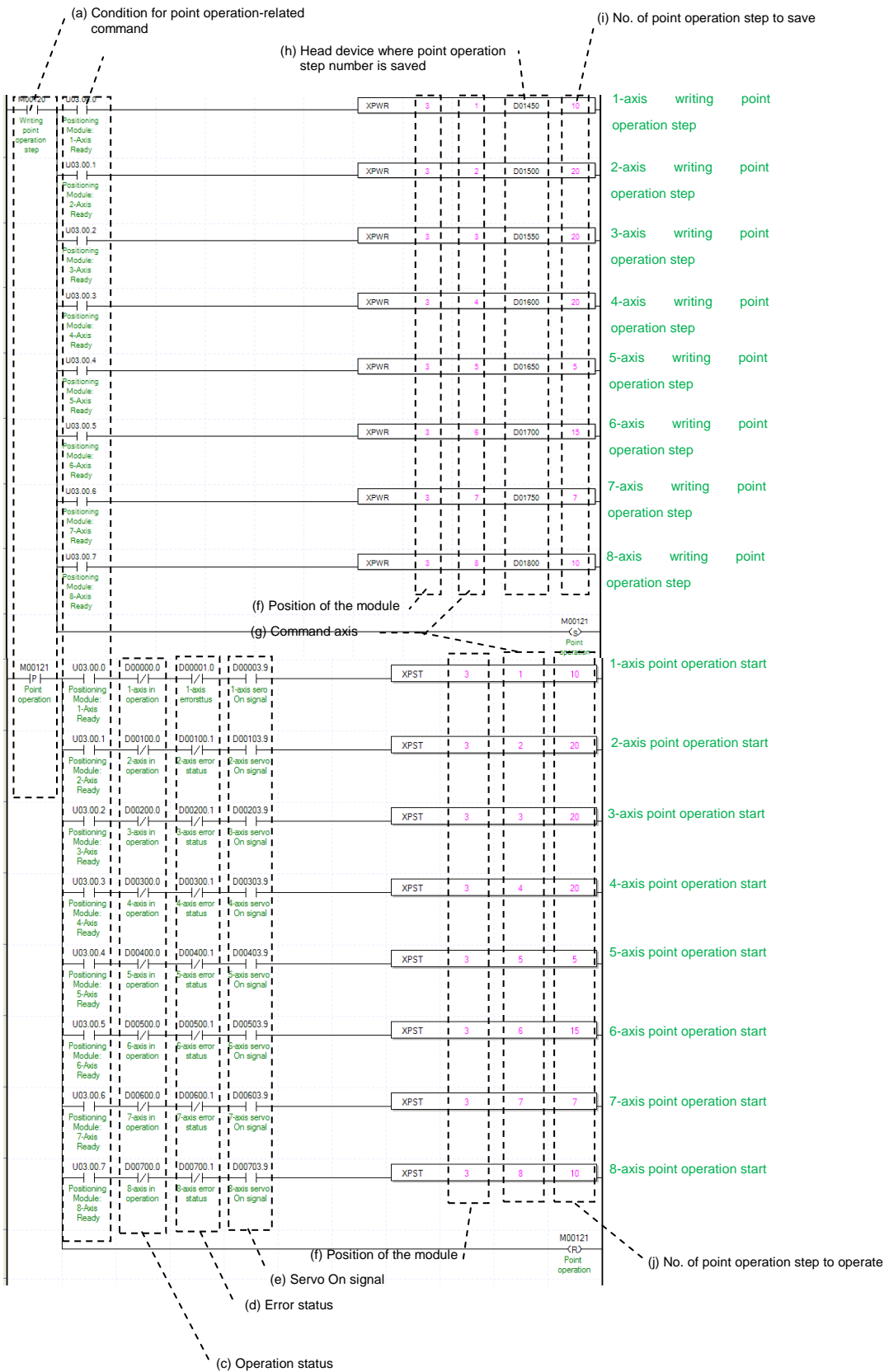

(a) Condition of Point Operation

Condition of Point Operation Command (XPST) Point Operation Step Writing (XPWR) XPWR has to be done before execute the Point Operation.

(b) Axis ready status

If communication between positioning module and servo drive is done, the signal corresponding to each signal will be on.

(c) Operating state by axis

According to exercise from “Chapter 8.1.2 Current State Reading,” it is a signal of “Operating” for each axis. It turns on when it is operating. Point operation start command can not be configured while it is running hence configuration will only be configured when it is not running. If you execute Point Operation while it is running, the “error 231” would be appeared.

(d) Error state for each axis

According to exercise from “Chapter 8.1.2 Current State Reading,” it is a signal of “Error state” for each axis. It turns on when an error occurred. Operation will only work when there is no error. If you want to operate a system regardless of errors, you can just inactivate the function.

(e) Servo On signal

When applying the example program of “8.1.2 Current State Read”, this is “Servo On” signal for each axis. When each axis is Servo On state, it will be on. Since “Point operation start” command can’t be executed when the axis is not servo on, it makes command executed when servo driver is “Servo On” state.

(f) Address of Positioning Module

In this example, Positioning Module installed at the slot no.3 of 0 bases.

(g) Axis of command execution

You can set an axis for Point Operation. XBF-PN04(8)B can supports for 4(8) axes. In the “execution of axis” from the configuration of Point Operation, you can set a value for axis 1 through 4(8) axis.

(h) Address of first device where those data for Step Numbers of Point Operation are saved

To execute a Point Operation, you need to set a specific value first. XPWR commands are using for set up those Point Operation steps. It has to be done before actual Point Operation. Point Operation Step Data will be set up depends on number of first device as below table.

Value	Device No.	Point start step data
1	Device + 0	Point start step data 1
2	Device + 1	Point start step data 2
3	Device + 2	Point start step data 3
4	Device + 3	Point start step data 4
5	Device + 4	Point start step data 5
6	Device + 5	Point start step data 6
7	Device + 6	Point start step data 7
8	Device + 7	Point start step data 8
9	Device + 8	Point start step data 9
10	Device + 9	Point start step data 10
11	Device + 10	Point start step data 11
12	Device + 11	Point start step data 12
13	Device + 12	Point start step data 13
14	Device + 13	Point start step data 14
15	Device + 14	Point start step data 15
16	Device + 15	Point start step data16
17	Device + 16	Point start step data17
18	Device + 17	Point start step data18
19	Device + 18	Point start step data19
20	Device + 19	Point start step data20

(i) Amount of Saving Point Operation Steps

Decide how many data will be saved by using XTWR command. In this example above, 10 Point Operation steps are saved in the axis 1. Therefore those Step data from D01450~D01459 are saved in the module.

(j) Number of Operation amount by Point Operation

Set the number of saving Step numbers by Point Operating Writing command. For more information, reference for Setting of Point Operation is in the “Chapter 9.2.18.”

(k) In this program above, you can use command “PUT” instead of XPWR.

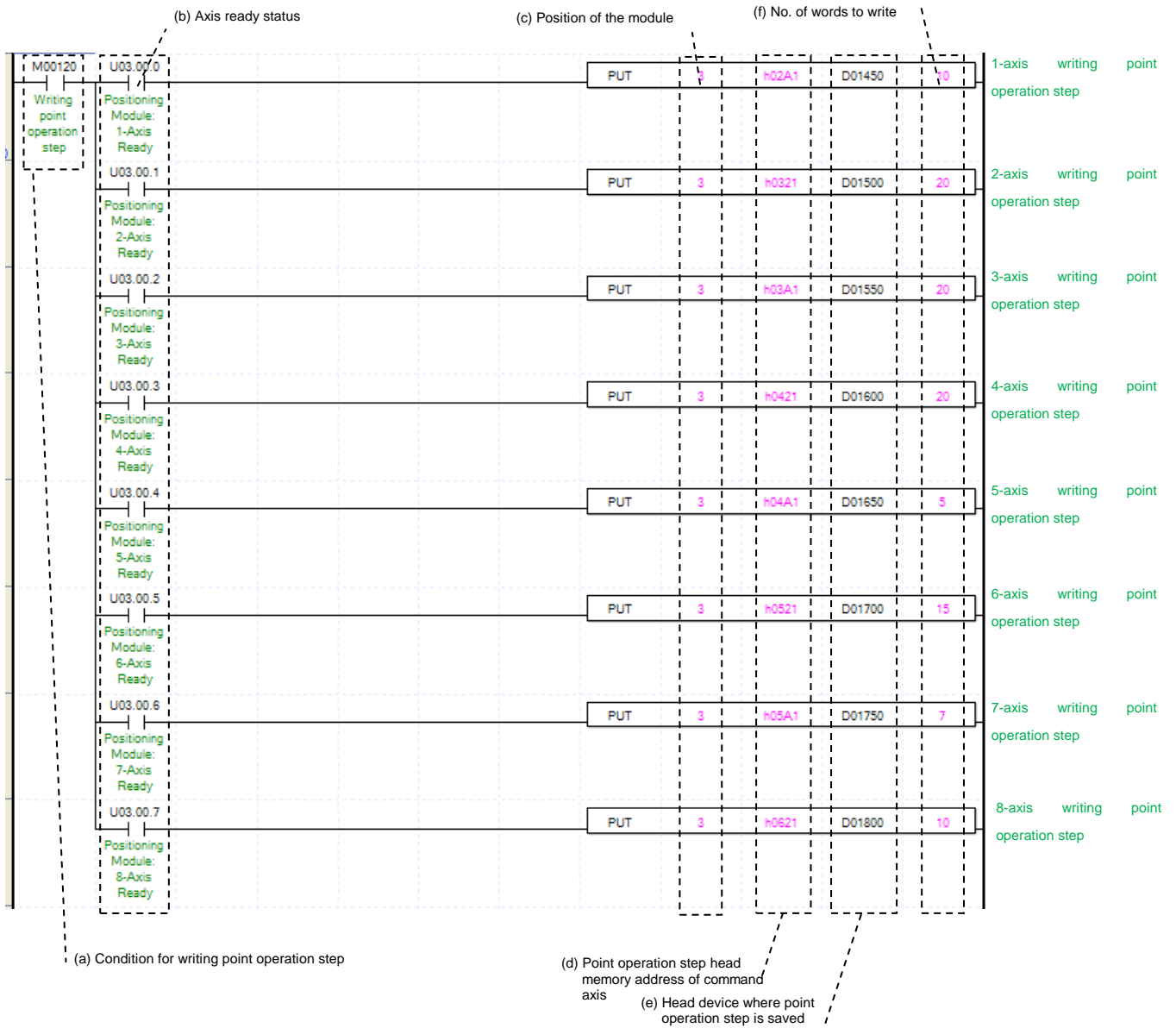

Setting a memory address for each axis of Point Operation step number, look up reference for Point Operation is in the “Chapter5.1.1.”

(7) Speed Synchronization

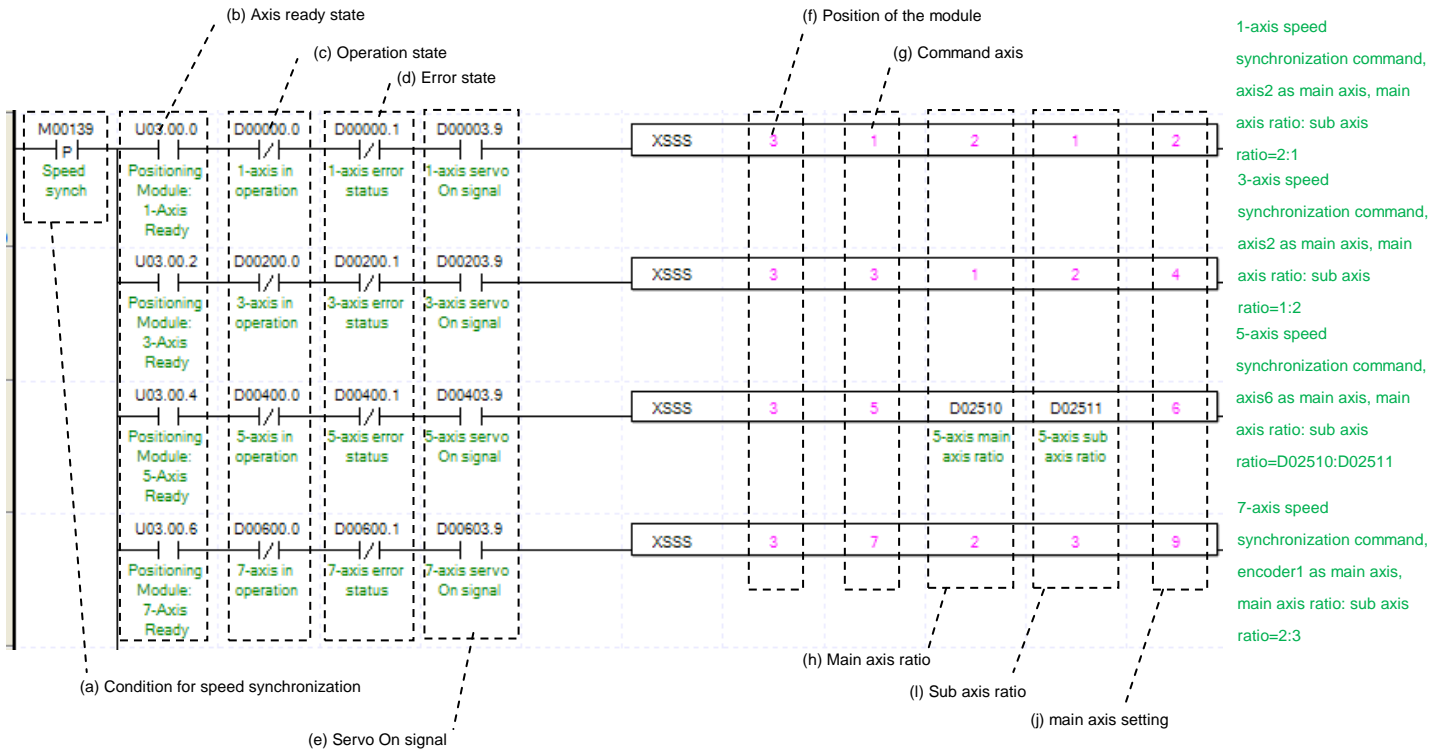

- (a) Condition of Speed Synchronization
Condition of Speed Synchronization Command (XSSS)
- (b) Axis ready status
If communication between positioning module and servo drive is done, the signal corresponding to each signal will be on.
- (c) Operating state by axis
According to exercise from “Chapter 8.1.2 Current State Reading,” it is a signal of “Operating” for each axis. It turns on when it is operating. Operating Data Setting can not be configured while it is running hence configuration will only be configured when it is not running. If you execute Speed Synchronization while it is running, the “error 351” would be appeared.
- (d) Error state for each axis
According to exercise from “Chapter 8.1.2 Current State Reading,” it is a signal of “Error state” for each axis. It turns on when an error occurred. Operation will only work when there is no error. If you want to operate a system regardless of errors, you can just inactivate the function.
- (e) Servo On signal
When applying the example program of “8.1.2 Current State Read”, this is “Servo On” signal for each axis. When each axis is Servo On state, it will be on. Since “Speed synchronization” command can’t be executed when the axis is not servo on, it makes command executed when servo driver is “Servo On” state. If you execute this command when it is not “Servo On” state, number 354 error will appears
- (f) Address of Positioning Module
In this example, Positioning Module installed at the slot no.3 of 0 bases.
- (g) Axis of command execution
You can set an axis for Speed Synchronization. XBF-PN04(8)B can supports for 4(8) axes. In the “execution of axis” from the configuration of Speed Synchronization, you can set a value for axis 1 through 4(8) axis.
- (h) Ratio of Main Axis
Set value for Ratio of Main Axis to execute a Speed Synchronization.

(i) Ratio of Subordinate Axis

Set value for Ratio of Subordinate Axis to execute a Speed Synchronization. In this example above, the ratio of main and subordinate axis is 2:1. Meaning that operational speed ratio of those axis is 2 to 1. So, if main axis is operating in speed of 10000, subordinate axis will be operating in speed of 5000.

(j) Main Axis Setting

Setting of main axis to operate Speed Synchronization. This setting is for main axis of Speed Synchronization. This setting cannot be set as same value as command axis, and possible setting values are as below.

Setting value	Main Axis
1	Axis1
2	Axis2
3	Axis3
4	Axis4
5	Axis5
6	Axis6
7	Axis7
8	Axis8
9	Encoder1

(k) For more information, reference for Speed Synchronization is in the “Chapter 9.4.1.”

(8) Position Assign Speed Synchronization

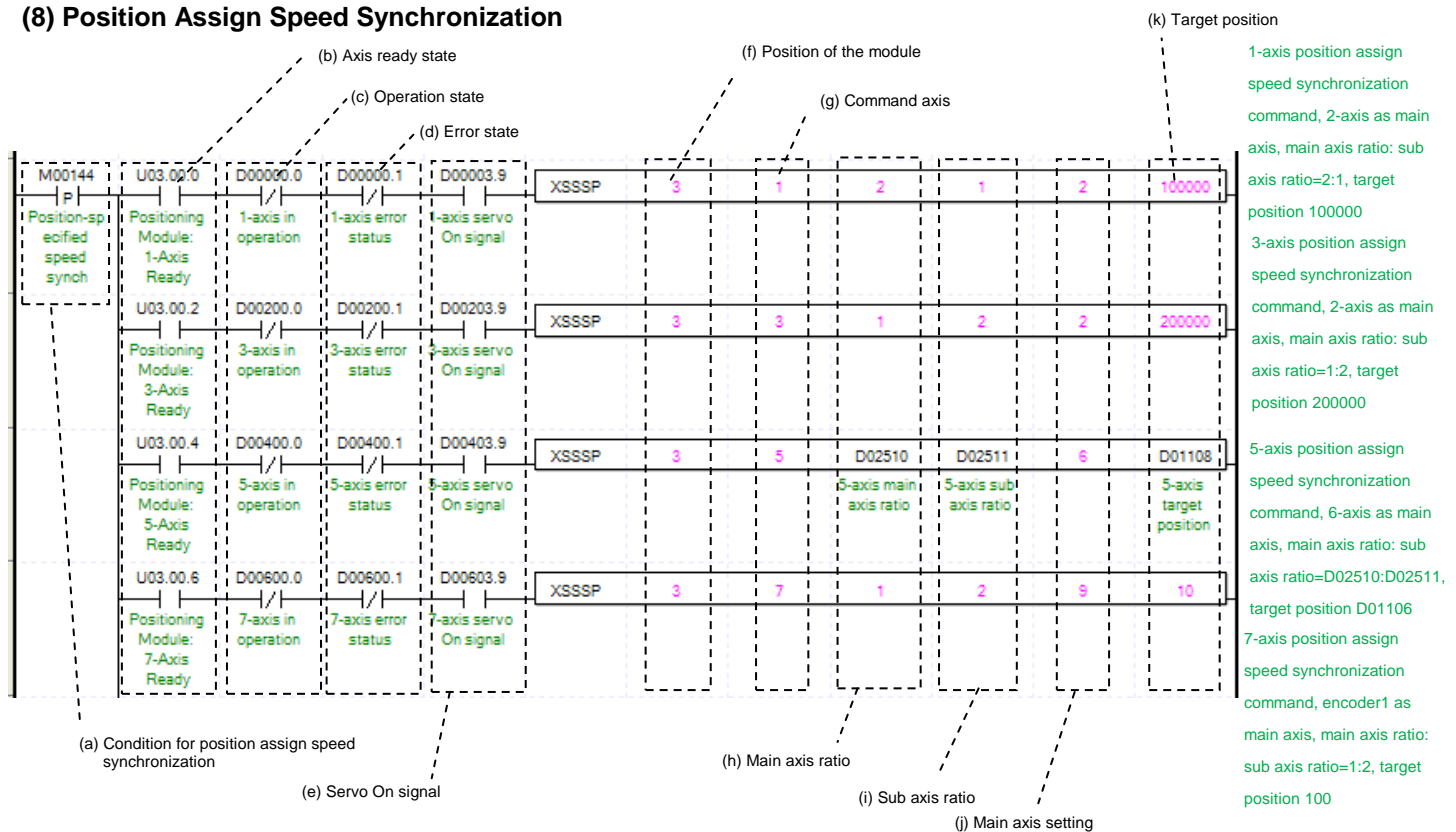

(a) Condition of Position Assign Speed Synchronization
Condition of Position Assign Speed Synchronization Command (XSSSP)

(b) Axis ready status

If communication between positioning module and servo drive is done, the signal corresponding to each signal will be on.

(c) Operating state by axis

According to exercise from “Chapter 8.1.2 Current State Reading,” it is a signal of “Operating” for each axis. It turns on when it is operating. Operating Data Setting can not be configured while it is running hence configuration will only be configured if it is not running. If you execute Position Assign Speed Synchronization while it is running, the “error 351” would be appeared.

(d) Error state for each axis

According to exercise from “Chapter 8.1.2 Current State Reading,” it is a signal of “Error state” for each axis. It turns on when an error occurred. Operation will only work when there is no error. If you want to operate a system regardless of errors, you can just inactivate the function.

(e) Servo On signal

When applying the example program of “8.1.2 Current State Read”, this is “Servo On” signal for each axis. When each axis is Servo On state, it will be on. Since “Speed synchronization” command can’t be executed when the axis is not servo on, it makes command executed when servo driver is “Servo On” state. If you execute this command when it is not “Servo On” state, number 354 error will appears

(f) Address of Positioning Module

In this example, Positioning Module installed at the slot no.3 of 0 bases.

(g) Axis of command execution

You can set an axis for Position Assign Speed Synchronization. XBF-PN04(8)B can supports for 4(8) axes. In the “execution of axis” from the configuration of Position Assign Speed Synchronization, you can set a value for axis 1 through 4(8) axis.

(h) Ratio of Main Axis

Set value for Ratio of Main Axis to execute a Speed Synchronization.

(i) Ratio of Subordinate Axis

Set value for Ratio of Subordinate Axis to execute a Speed Synchronization. In this example above, the ratio of main and subordinate axis is 2:1. Meaning that operational speed ratio of those axis is 2 to 1. So, if main axis is operating in speed of 10000, subordinate axis will be operating in speed of 5000.

(j) Main Axis Setting

Setting of main axis to operate Speed Synchronization. This setting is for main axis of Speed Synchronization. This setting cannot be set as same value as command axis, and possible setting values are as below.

Setting value	Main Axis
1	Axis1
2	Axis2
3	Axis3
4	Axis4
5	Axis5
6	Axis6
7	Axis7
8	Axis8
9	Encoder1

(k) Goal Position

Set goal of Position Assign Speed Synchronization. Once command axis reaches the goal position, Speed Synchronization ends and operation will be stop immediately.

(l) For more information, reference for Position Assign Speed Synchronization is in the “Chapter 9.4.1.”

(9) Synchronous Start by Position

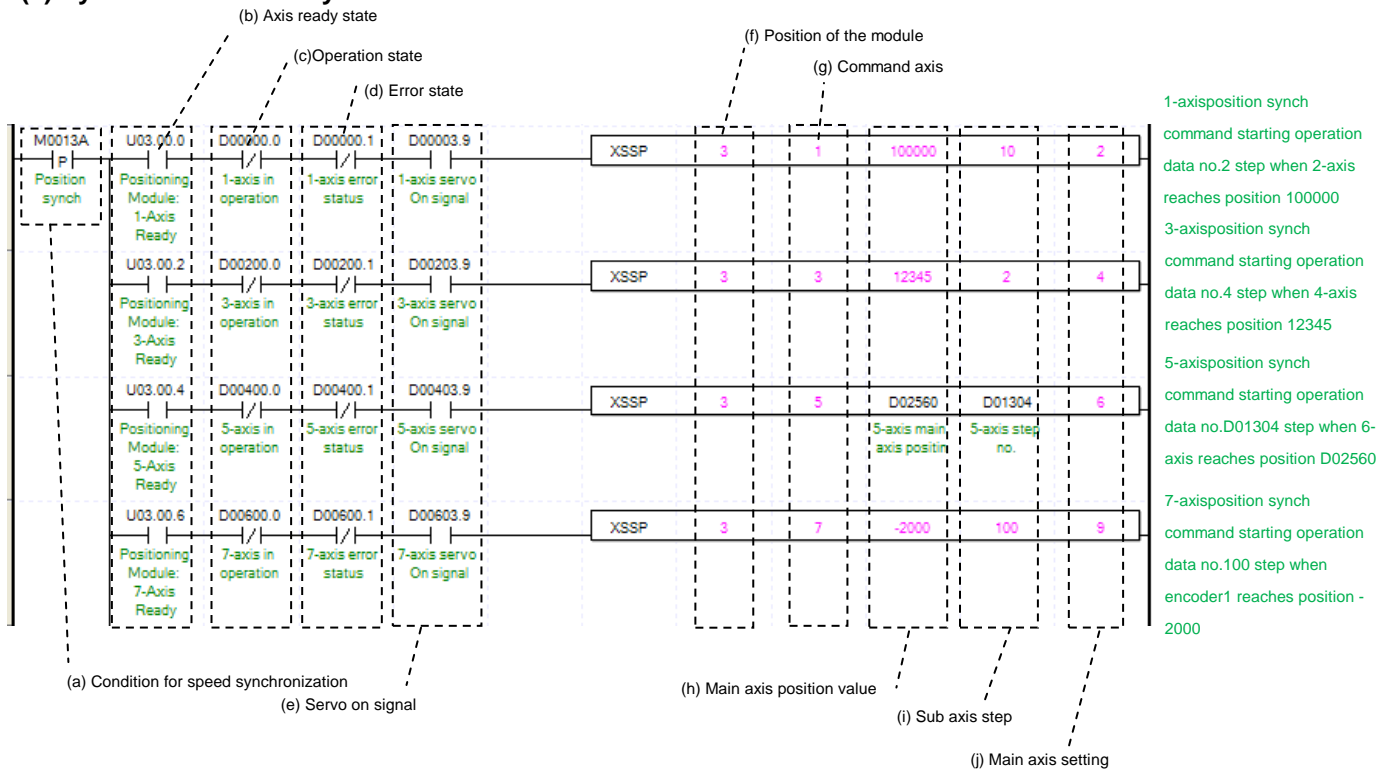

(a) Condition of Synchronous Start by Position
Condition of Synchronous Start by Position Command (XSSP)

(b) Axis ready status

If communication between positioning module and servo drive is done, the signal corresponding to each signal will be on.

(c) Operating state by axis

According to exercise from “Chapter 8.1.2 Current State Reading,” it is a signal of “Operating” for each axis. It turns on when it is operating. Operating Data Setting can not be configured while it is running hence configuration will only be configured when it is not running. If you execute Synchronous Start by Position while it is running, the “error 341” would be appeared.

(d) Error state for each axis

According to exercise from “Chapter 8.1.2 Current State Reading,” it is a signal of “Error state” for each axis. It turns on when an error occurred. Operation will only work when there is no error. If you want to operate a system regardless of errors, you can just inactivate the function.

(e) Servo On signal

When applying the example program of “8.1.2 Current State Read”, this is “Servo On” signal for each axis. When each axis is Servo On state, it will be on. Since “Speed synchronization” command can’t be executed when the axis is not servo on, it makes command executed when servo driver is “Servo On” state. If you execute this command when it is not “Servo On” state, number 354 error will appears

(f) Address of Positioning Module

In this example, Positioning Module installed at the slot no.3 of 0 bases.

(g) Axis of command execution

You can set an axis for Synchronous Start by Position. XBF-PN04(8)B can supports for 4(8) axes. In the “execution of axis” from the configuration of Synchronous Start by Position, you can set a value for axis 1 through 4(8) axis.

(h) Value of Main Axis

Set value for Main Axis to execute Synchronous Start by Position. Therefore main axis will be executed the command when the subordinate axis reaches this set value.

(i) Step of Subordinate Axis

Set step number for Subordinate Axis to execute a Speed Synchronization.

(j) Main Axis Setting

Setting of main axis to operate Speed Synchronization. This setting is for main axis of Speed Synchronization. This setting cannot be set as same value as command axis, and possible setting values are as below.

Setting value	Main Axis
1	Axis1
2	Axis2
3	Axis3
4	Axis4
5	Axis5
6	Axis6
7	Axis7
8	Axis8
9	Encoder1

(k) For more information, reference for Synchronous Start by Position is in the “Chapter 9.4.2.”

(10) CAM Operation

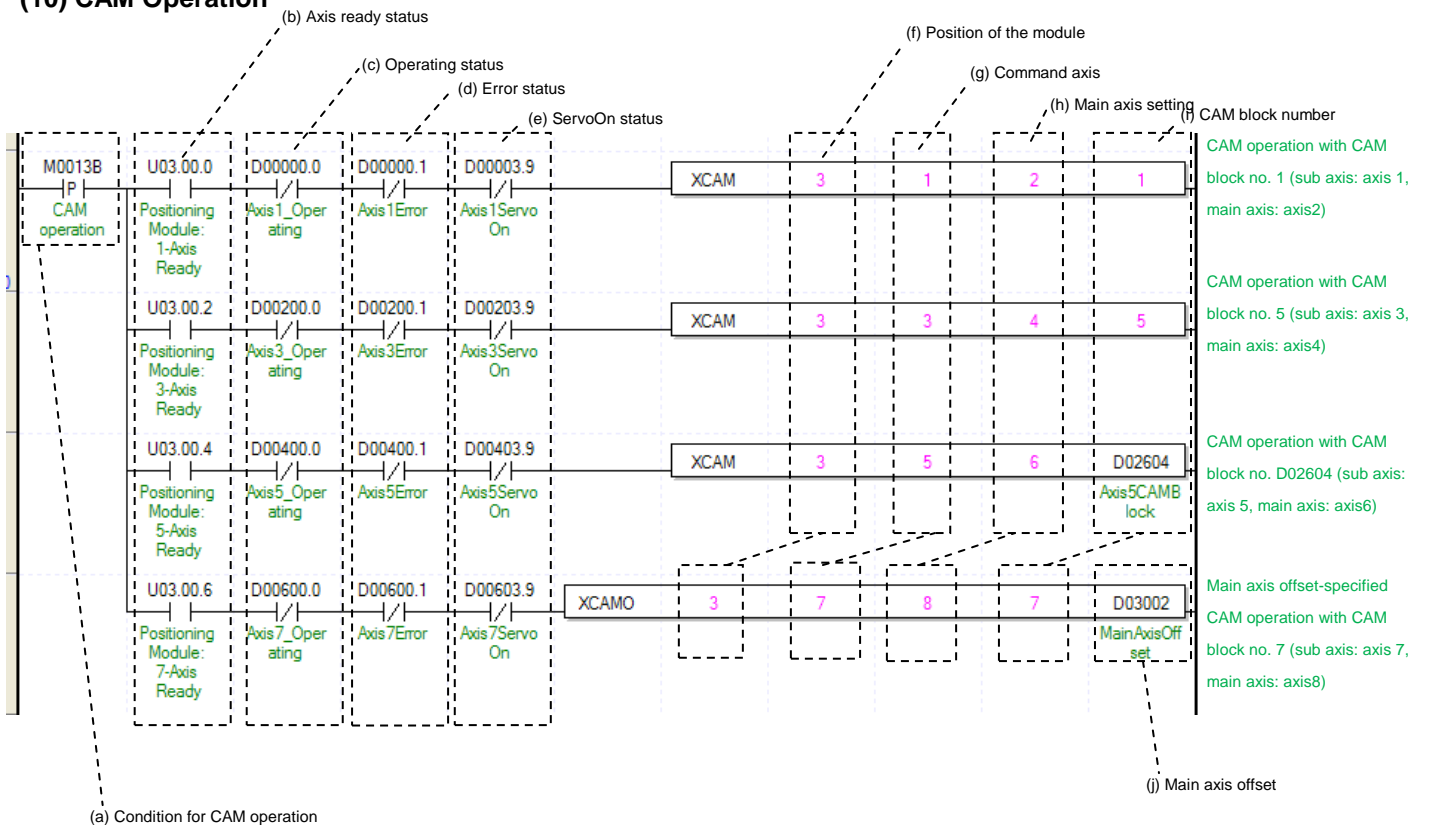

(a) Condition of CAM Operation

Condition of CAM Operation Command (XCAM)

(b) Axis ready status

If communication between positioning module and servo drive is done, the signal corresponding to each signal will be on.

- (c) Operating state by axis
According to exercise from “Chapter 8.1.2 Current State Reading,” it is a signal of “Operating” for each axis. It turns on when it is operating. Operating Data Setting can not be configured while it is running hence configuration will only be configured when it is not running. If you execute CAM Operation while it is running, the “error 701” would be appeared.
- (d) Error state for each axis
According to exercise from “Chapter 8.1.2 Current State Reading,” it is a signal of “Error state” for each axis. It turns on when an error occurred. Operation will only work when there is no error. If you want to operate a system regardless of errors, you can just inactivate the function.
- (e) Servo On signal
When applying the example program of “8.1.2 Current State Read”, this is “Servo On” signal for each axis. When each axis is Servo On state, it will be on. Since “Speed synchronization” command can’t be executed when the axis is not servo on, it makes command executed when servo driver is “Servo On” state. If you execute this command when it is not “Servo On” state, number 354 error will appears
- (f) Address of Positioning Module
In this example, Positioning Module installed at the slot no.3 of 0 bases.
- (g) Axis of command execution
You can set an axis for CAM Operation. XBF-PN04(8)B can supports for 4(8) axes. In the “execution of axis” from the configuration of CAM Operation, you can set a value for axis 1 through 4(8) axis.
- (h) Main Axis Setting
Setting of main axis to operate .This setting is for main axis of CAM Operating. This setting cannot be set as same value as command axis. Can set a value 1~4, meaning from axis 1 to axis 4.
- (i) CAM Block Numbers
Setting for Block Numbers of CAM data to operate CAM operation. You can set up 9 CAM Blocks. The CAM Data for each Block would be downloaded to module written from Software Package.
- (j) Main axis offset
In case of main axis offset specified CAM operation command, sets offset position of main axis for sub axis to start CAM operation. After operation, sub-axis starts CAM operation after main axis moves as much as position value set in main axis offset
- (k) For more information, reference of CAM Operation is in the “Chapter 9.4.3.”

(11) Deceleration Stop

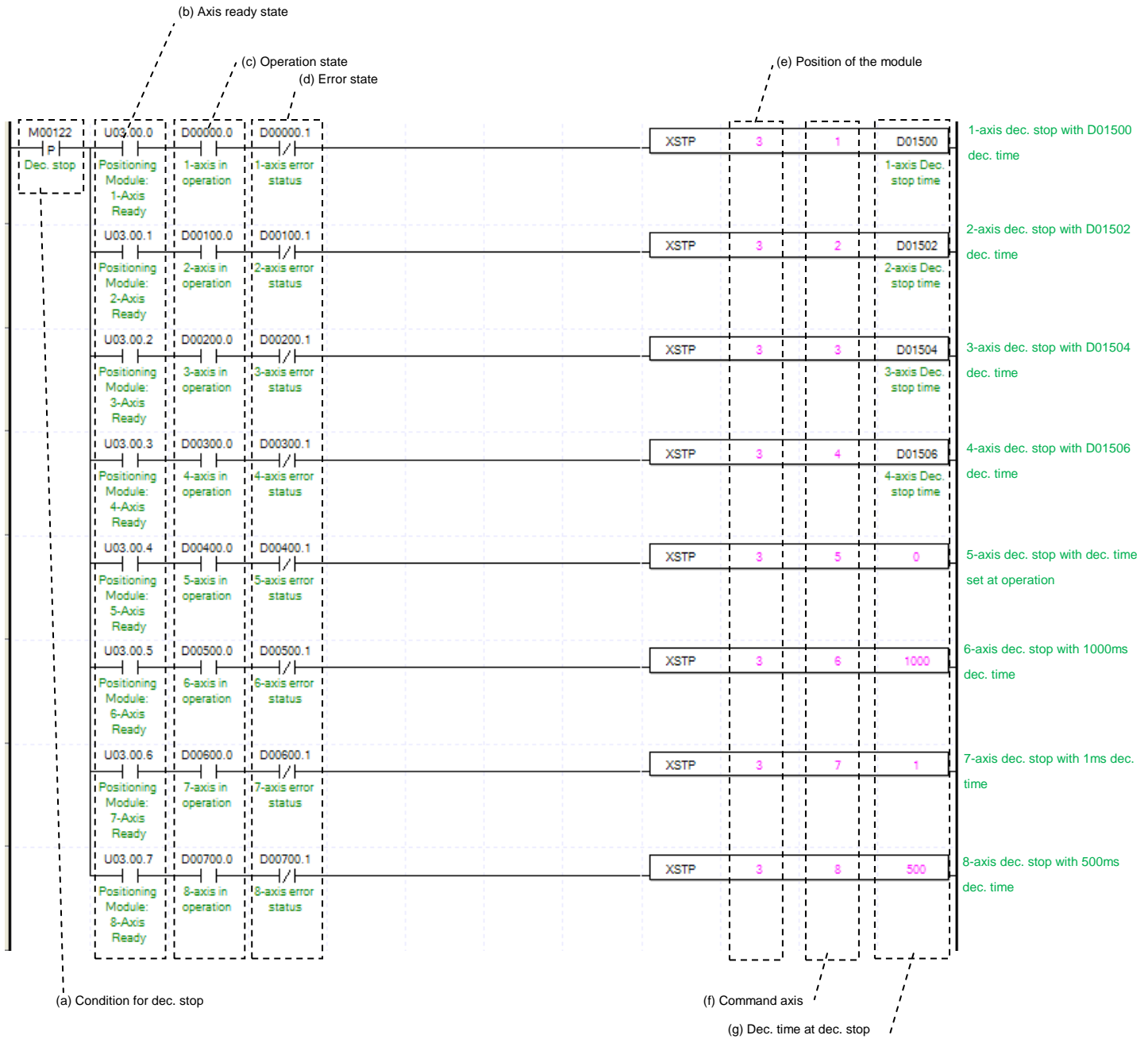

(a) Condition of Deceleration Stop
Condition of Deceleration Stop Command (XSTP)

(b) Axis ready status
If communication between positioning module and servo drive is done, the signal corresponding to each signal will be on.

(c) Operating state by axis
According to exercise from “Chapter 8.1.2 Current State Reading,” it is a signal of “Operating” for each axis. It turns on when it is operating. Operating Data Setting can not be configured while it is running hence configuration will only be configured when it is not running.

(d) Error state for each axis
According to exercise from “Chapter 8.1.2 Current State Reading,” it is a signal of “Error state” for each axis. It turns on when an error occurred. Operation will only work when there is no error. If you want to operate a system regardless of errors, you can just inactivate the function.

(e) Address of Positioning Module

In this example, Positioning Module installed at the slot no.3 of 0 bases.

(f) Axis of command execution

You can set an axis for Deceleration Stop. XBF-PN04(8)B can supports for 4(8) axes. In the “execution of axis” from the configuration of Deceleration Stop, you can set a value for axis 1 through 4(8) axis.

(g) Deceleration time of Deceleration Stop

Setting a deceleration time of Deceleration Stop operation. Unit of Deceleration Stop is [ms]. Since this time refers deceleration time from the speed limit, there might be little difference between Deceleration Stop set time and actual stop time. The range of deceleration time is “0~2,147,483,674.” 1~2,147,483,674 means Deceleration Time set as 1ms ~ 2,147483674ms. If it set as “0,” it will be operated with set deceleration value. Also it use to stop Speed Synchronous Operation or CAM Operation while Speed and CAM Operation. During this time Deceleration Time is meaningless, CAM Operation Is just cancelled.

(i) For more information, reference of Deceleration Stop is in the “Chapter 9.2.18.”

(12) Emergency Stop

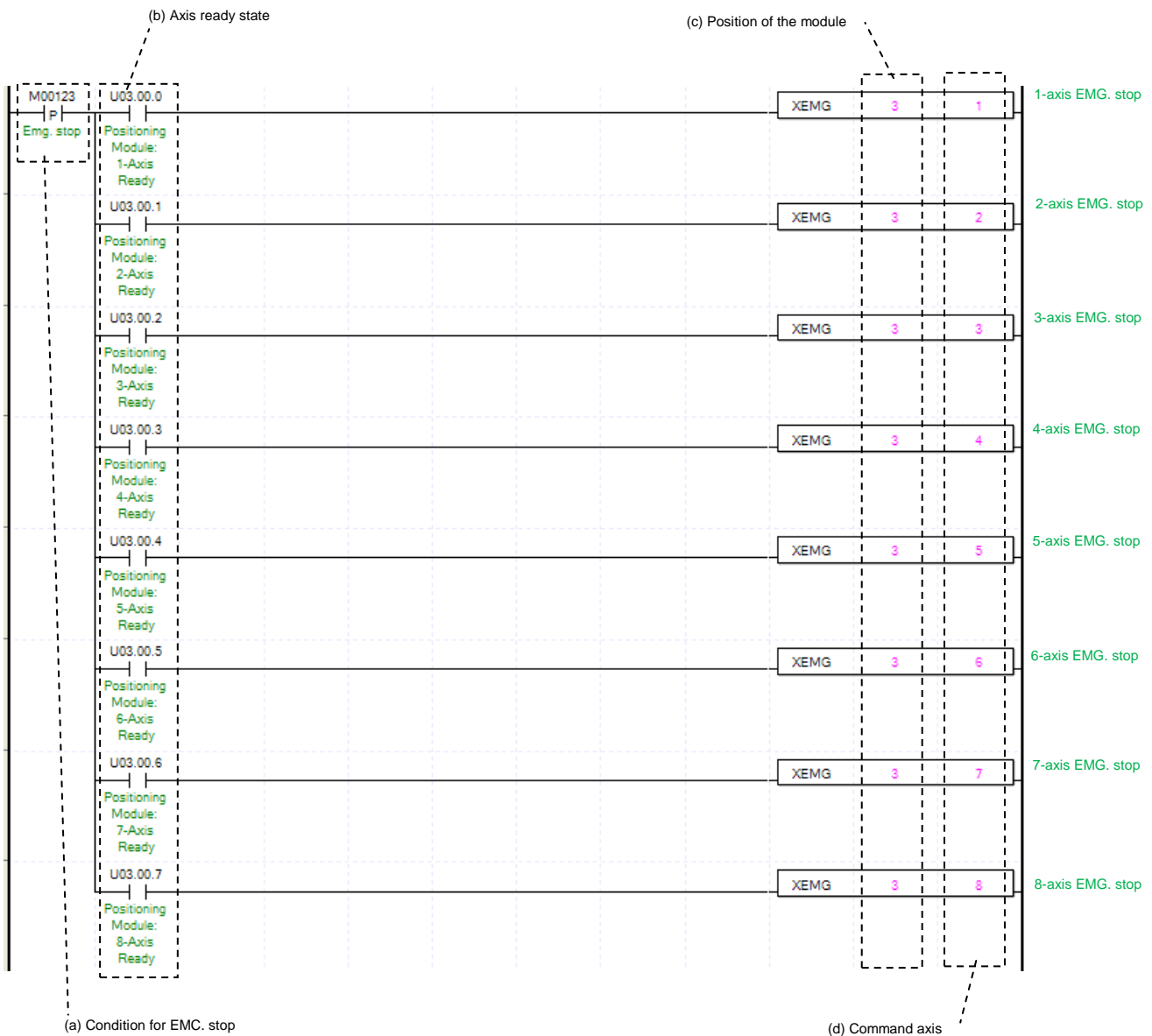

- (a) Condition of Emergency Stop
Condition of Emergency Stop Command (XEMG)
- (b) Axis ready status
If communication between positioning module and servo drive is done, the signal corresponding to each signal will be on.
- (c) Address of Positioning Module
In this example, Positioning Module installed at the slot no.3 of 0 bases.
- (d) Axis of command execution
You can set an axis for Emergency Stop. XBF-PN04(8)B can supports for 4(8) axes. In the “execution of axis” from the configuration of Emergency Stop, you can set a value for axis 1 through 4(8) axis.
- (e) Emergency Stop is operating by each axis.
Once Emergency Stop command executes the error “481” would be occurred. With the set value for deceleration time, it will be decelerated and stop the operation
- (f) For more information, reference of Emergency Stop is in the “Chapter 9.2.18.”

(13) M code Off

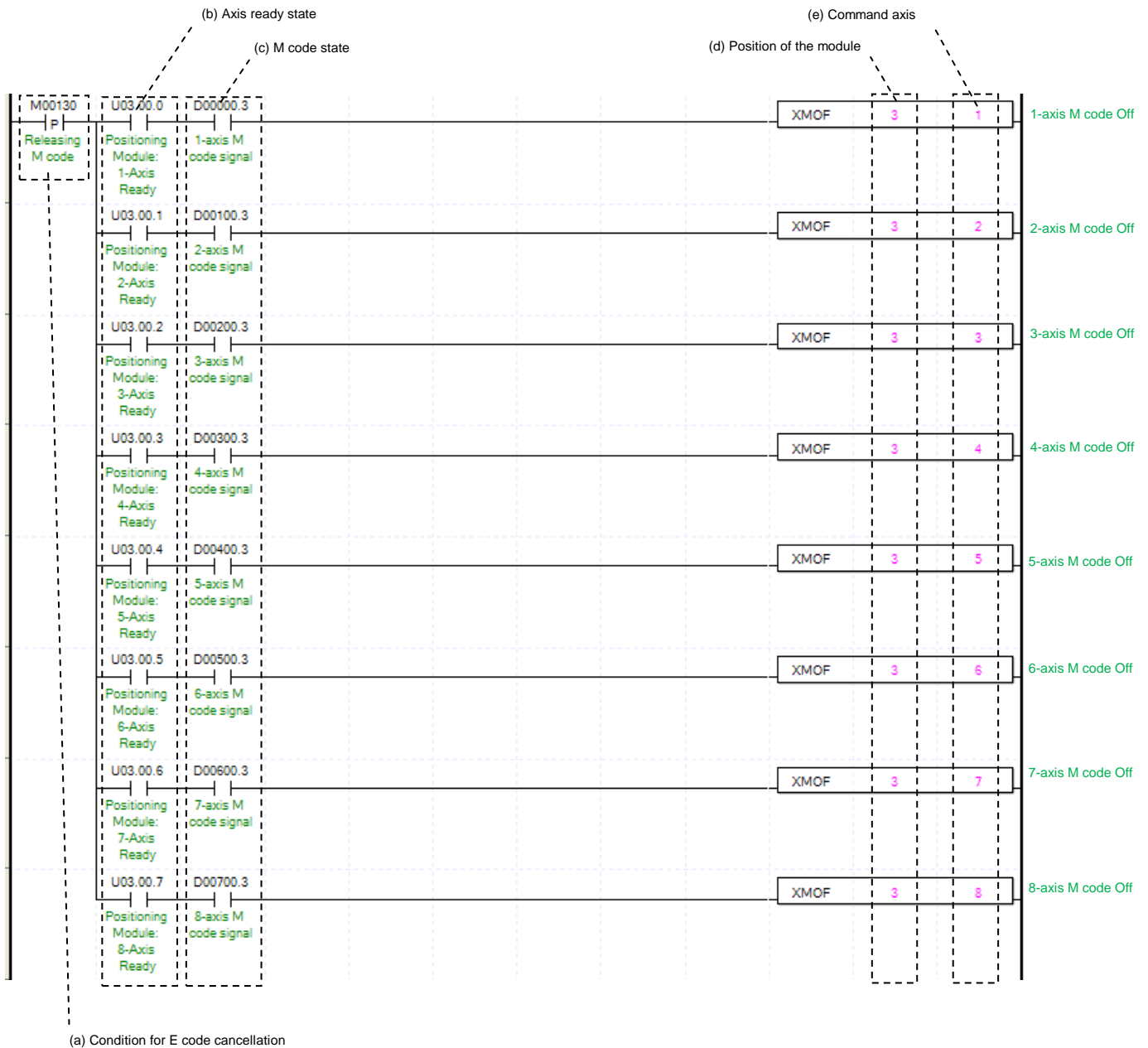

- (a) Condition of M code Off
Condition of M code Off(XMOF). Once M code Off command executed, number of M code would be change to "0," and signal of M code to "Off."
- (b) Axis ready status
If communication between positioning module and servo drive is done, the signal corresponding to each signal will be on.
- (c) M code state for each axis
According to exercise from "Chapter 8.1.2 Current State Reading," it is a signal of "M Code" for each axis. It turns on when it is operating. M code Off command can only be valid once M code are generated. The condition for execution is operation possible when it is "On."
- (d) Address of Positioning Module
In this example, Positioning Module installed at the slot no.3 of 0 bases.
- (e) Axis of command execution
You can set an axis for M code Off. XBF-PN04(8)B can supports for 4(8) axes. In the "execution of axis" from the configuration of M code Off, you can set a value for axis 1 through 4(8) axis.
- (f) For more information, reference of M code Off is in the "Chapter 9.6.2."

(14) Torque Control

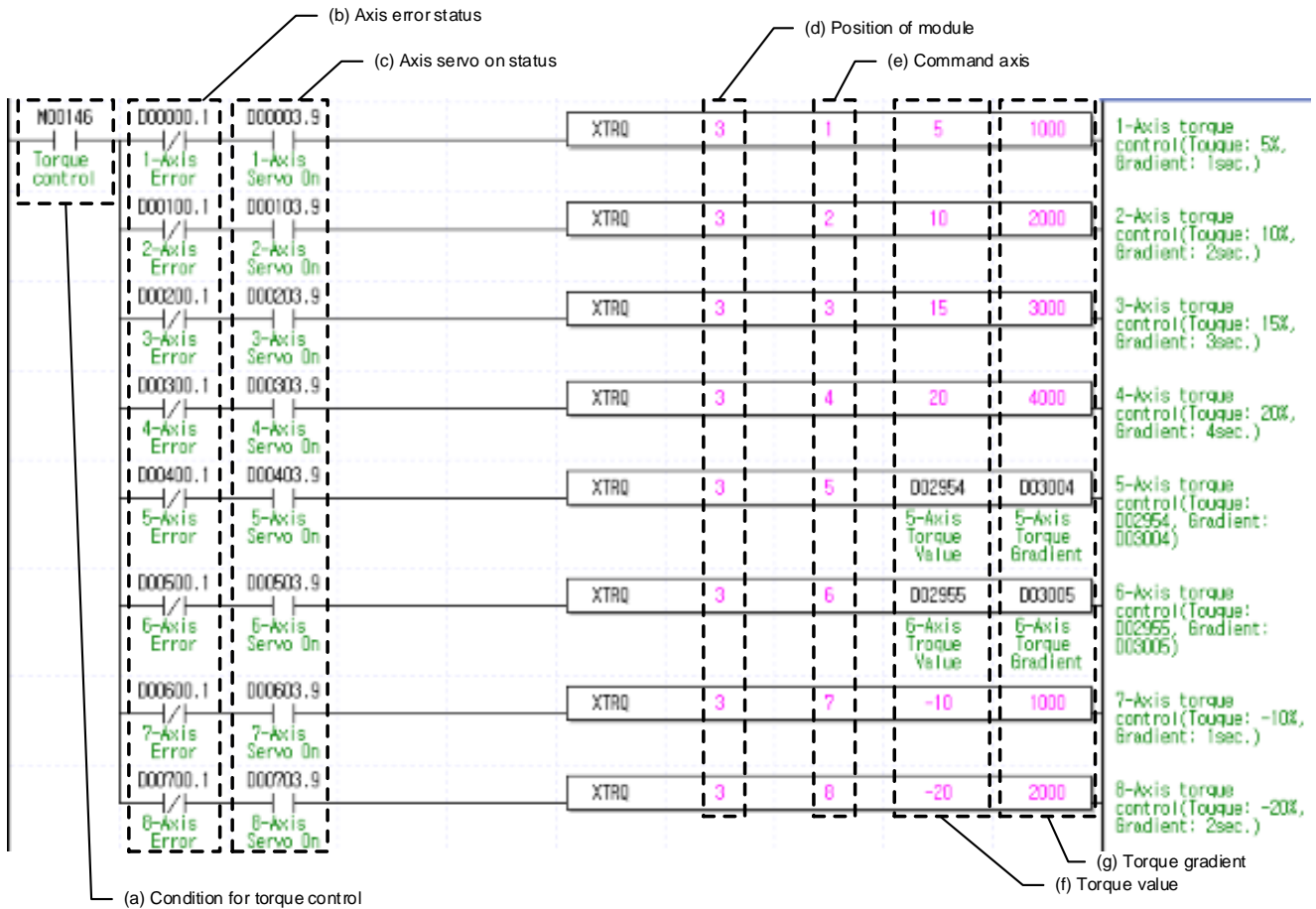

(a) Conditions to torque control

Conditions to implement the Torque Control command (XTRQ). If the command is implemented, the corresponding axis implements Torque Control with the set torque value and torque gradient.

(b) Error state of each axis

It is "Error State" signal of each axis when the example program of "8.1.2 Read the Current State" is applied. It shall be set to ensure any command is implemented only when a relevant axis has no error. This condition may be removed if the user wants to implement a command regardless of occurrence of error.

(c) Servo On Signal of each axis

It is "Servo On" signal of each axis when the example program of "8.1.2 Read the Current State" is applied. It is On when a relevant axis is the state of "Servo On." Since the Control Torque command cannot be implemented if the axis is not servo on, a condition to implement the command only in case of the state of servo on shall be set. If the Control Torque command is implemented when it is not the state of servo on, No. 743 error takes place.

(d) Address of Positioning Module

In this example, Positioning Module installed at the slot no.3 of 0 bases.

(e) Axis of command execution

It sets an axis that will implement the Control Torque command. Up to 4(8) axis can be connected to XBF-PN04(8)B and value 1 through 4(8), referring to Axis 1 through 4(8), can be set to "Axis to which Command is executed" item of the Torque Control command.

(f) After implementing the Torque Control command, set torque value to drive under the Torque Control command. The torque value range is -32768 through 32767%.

(g) Set gradient until reach the target torque in time. The gradient range is 0 through 65535ms.

(h) For further information on actions of the Torque Control command, refer to "9.2.21 Torque Control."

8.1.7 Operation Setting Change while Operating

(1) Speed Override

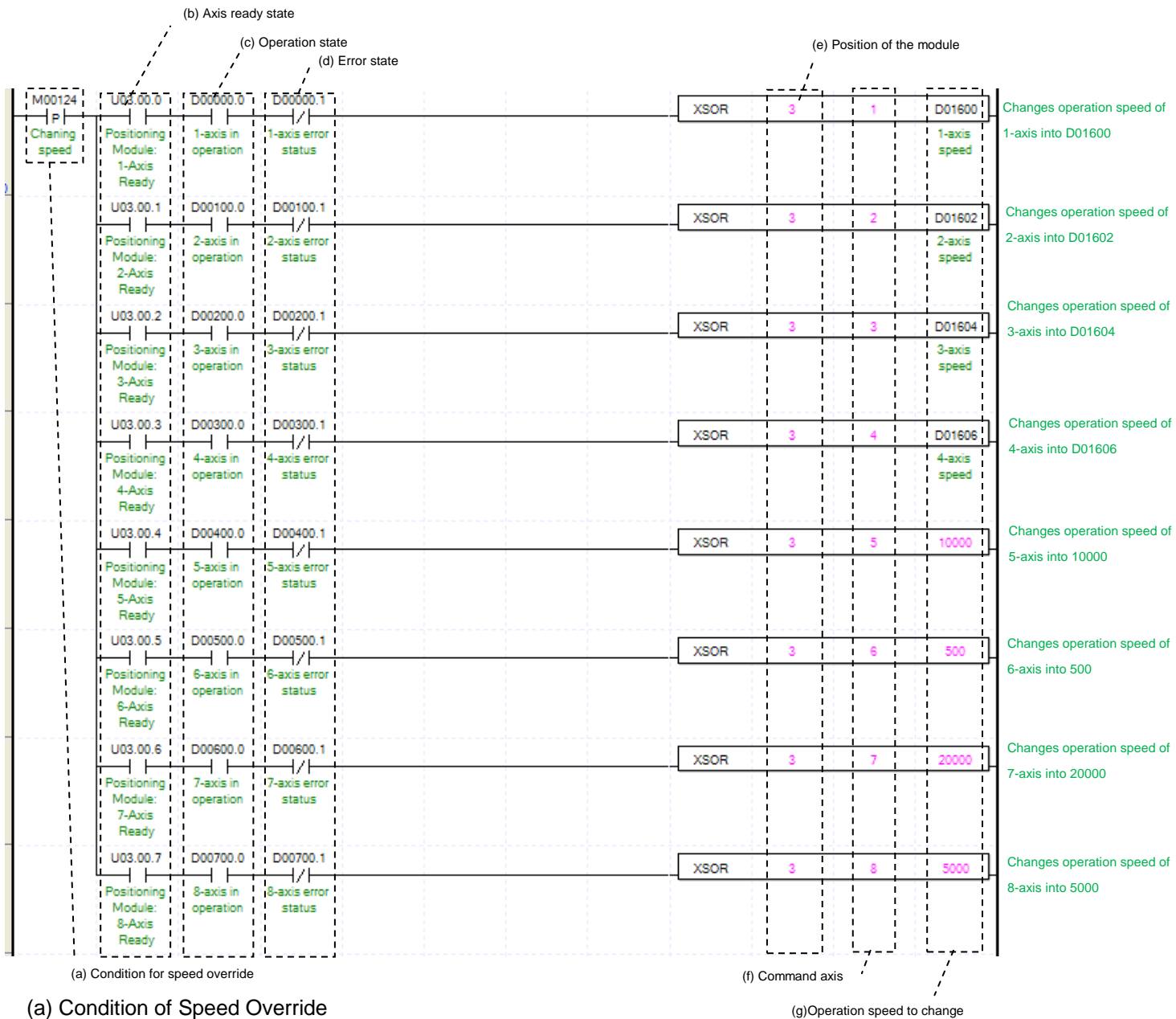

(a) Condition of Speed Override
 Condition of Speed Override Command (XSOR)

(b) Axis ready status

If communication between positioning module and servo drive is done, the signal corresponding to each signal will be on.

(c) Operating state by axis

According to exercise from “Chapter 8.1.2 Current State Reading,” it is a signal of “Operating” for each axis. It turns on when it is operating. Operating Data Setting can’t be configured while it is running hence configuration will only be configured when it is not running. If you execute Speed Override while it is running, the “error 371” would be appeared.

- (d) Error state for each axis
According to exercise from “Chapter 8.1.2 Current State Reading,” it is a signal of “Error state” for each axis. It turns on when an error occurred. Operation will only work when there is no error. If you want to operate a system regardless of errors, you can just inactivate the function.
- (e) Address of Positioning Module
In this example, Positioning Module installed at the slot no.3 of 0 bases.
- (f) Axis of command execution
You can set an axis for Speed Override. XBF-PN04(8)B can supports for 4(8) axes. In the “execution of axis” from the configuration of Speed Override, you can set a value for axis 1 through 4(8) axis.
- (g) Value Change for Speed Operation
Setting value change for speed operation. According to Speed Override from common parameters, it is a signal of “%” or “Speed Value” depends on setting of category. Also, when Speed Override set as Speed Value, it means Unit/Time depends on Speed Command Unit from basic parameters, or it means “rpm.” If a changing Operation Speed Value is “%,” then the unit would be $[X10^{-2}\%]$. If it is “rpm,” then the unit would be $X10^{-1}$ rpm].
- (h) For more information, reference of Speed Override is in the “Chapter 9.5.5.”

(2) Position Override

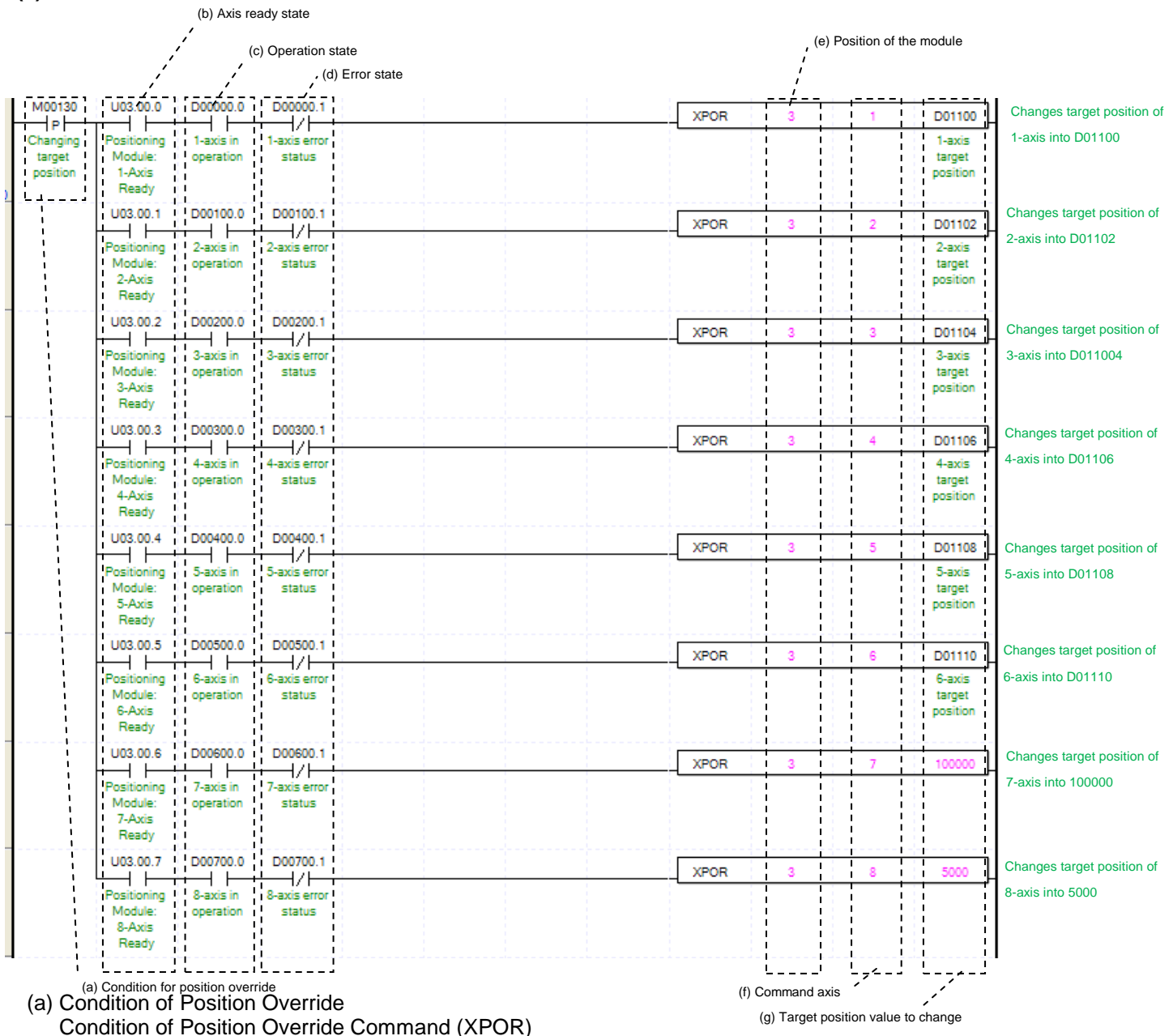

- (b) Axis ready status
If communication between positioning module and servo drive is done, the signal corresponding to each signal will be on.
- (c) Operating state by axis
According to exercise from “Chapter 8.1.2 Current State Reading,” it is a signal of “Operating” for each axis. It turns on when it is operating. Operating Data Setting can not be configured while it is running hence configuration will only be configured when it is not running. If you execute Position Override while it is running, the “error 361” would be appeared.
- (d) Error state for each axis
According to exercise from “Chapter 8.1.2 Current State Reading,” it is a signal of “Error state” for each axis. It turns on when an error occurred. Operation will only work when there is no error. If you want to operate a system regardless of errors, you can just inactivate the function.
- (e) Address of Positioning Module
In this example, Positioning Module installed at the slot no.3 of 0 bases.
- (f) Axis of command execution
You can set an axis for Position Override. XBF-PN04(8)B can supports for 4(8) axes. In the “execution of axis” from the configuration of Position Override, you can set a value for axis 1 through 4(8) axis.
- (g) Change for Goal Position Value
Setting Value Change for Goal Position Value. The unit of this value depends on “Unit” category. Once Position Override commands are executed, the goal position of executed axis will be changed to set goal position.
- (h) For more information, reference of Position Override is in the “Chapter 9.5.4.”

(3) Position Assign Speed Override

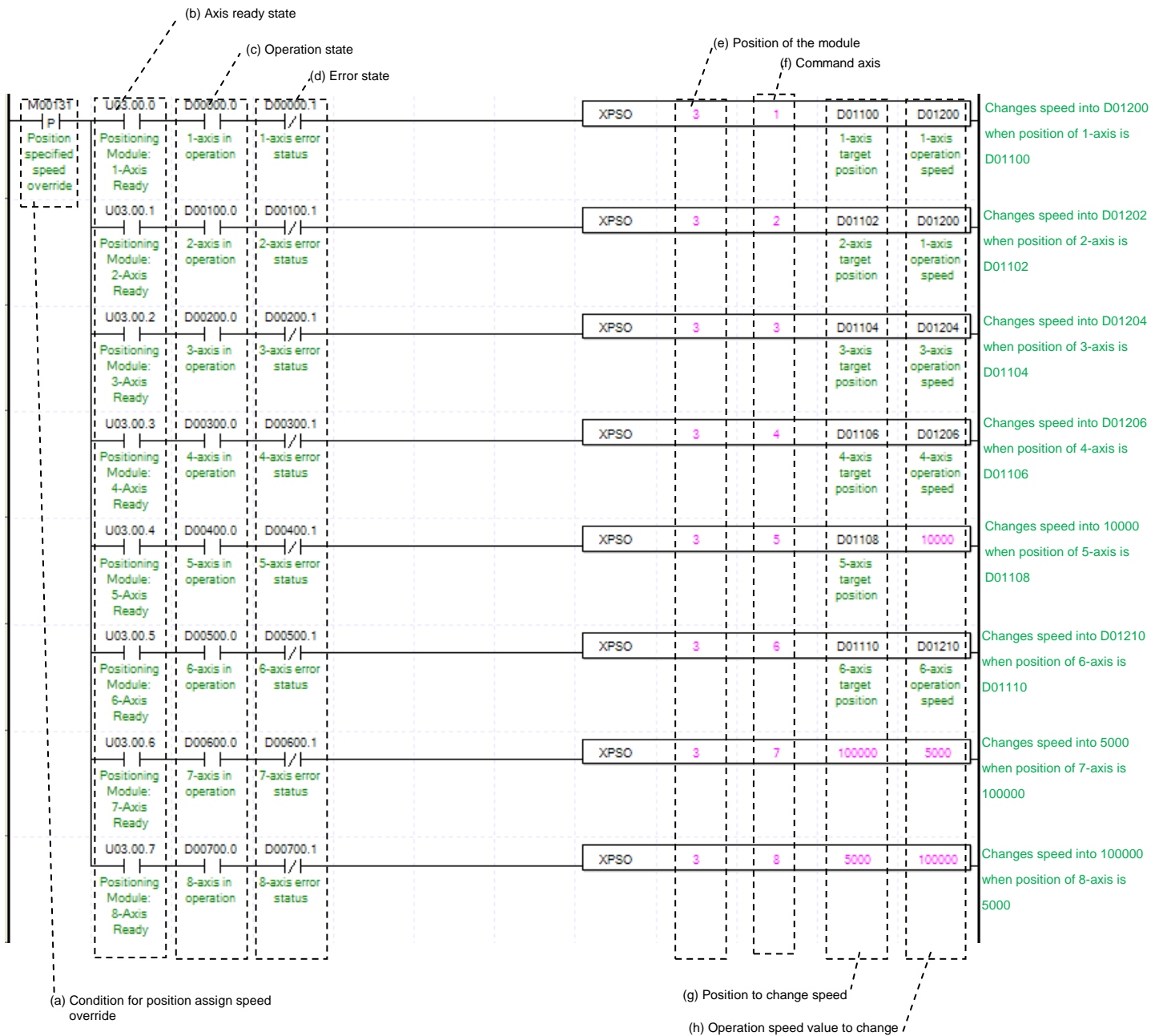

(a) Condition of Position Assign Speed Override
Condition of Position Assign Speed Override Command (XPSO)

(b) Axis ready status
If communication between positioning module and servo drive is done, the signal corresponding to each signal will be on.

(c) Operating state by axis
According to exercise from “Chapter 8.1.2 Current State Reading,” it is a signal of “Operating” for each axis. It turns on when it is operating. Operating Data Setting can not be configured while it is running hence configuration will only be configured when it is not running. If you execute Position Assign Speed Override while it is running, the “error 381” would be appeared.

- (d) Error state for each axis
According to exercise from “Chapter 8.1.2 Current State Reading,” it is a signal of “Error state” for each axis. It turns on when an error occurred. Operation will only work when there is no error. If you want to operate a system regardless of errors, you can just inactivate the function.
- (e) Address of Positioning Module
In this example, Positioning Module installed at the slot no.3 of 0 bases.
- (f) Axis of command execution
You can set an axis for Position Assign Speed Override. XBF-PN04(8)B can supports for 4(8) axes. In the “execution of axis” from the configuration of Position Assign Speed Override, you can set a value for axis 1 through 4(8) axis.
- (g) Position of Speed Change Execution
Setting position of Speed Change. Once the actual position located at set position with speed override command running, the speed change commands are executed.
- (h) Value Change for Operation speed
Setting Value Change for Operation speed. According to Speed Override from common parameters, it is a signal of “%” or “Speed Value” depends on setting of category. Also, when Speed Override set as Speed Value, it means Unit/Time depends on Speed Command Unit from basic parameters, or it means “rpm.” If a changing Operation Speed Value is “%,” then the unit would be $[X10^{-2}\%]$. If it is “rpm,” then the unit would be $X10^{-1}\text{rpm}$.
- (i) For more information, reference of Position Assign Speed Override is in the “Chapter 9.5.6.”

(4) Speed/Position Switching Control

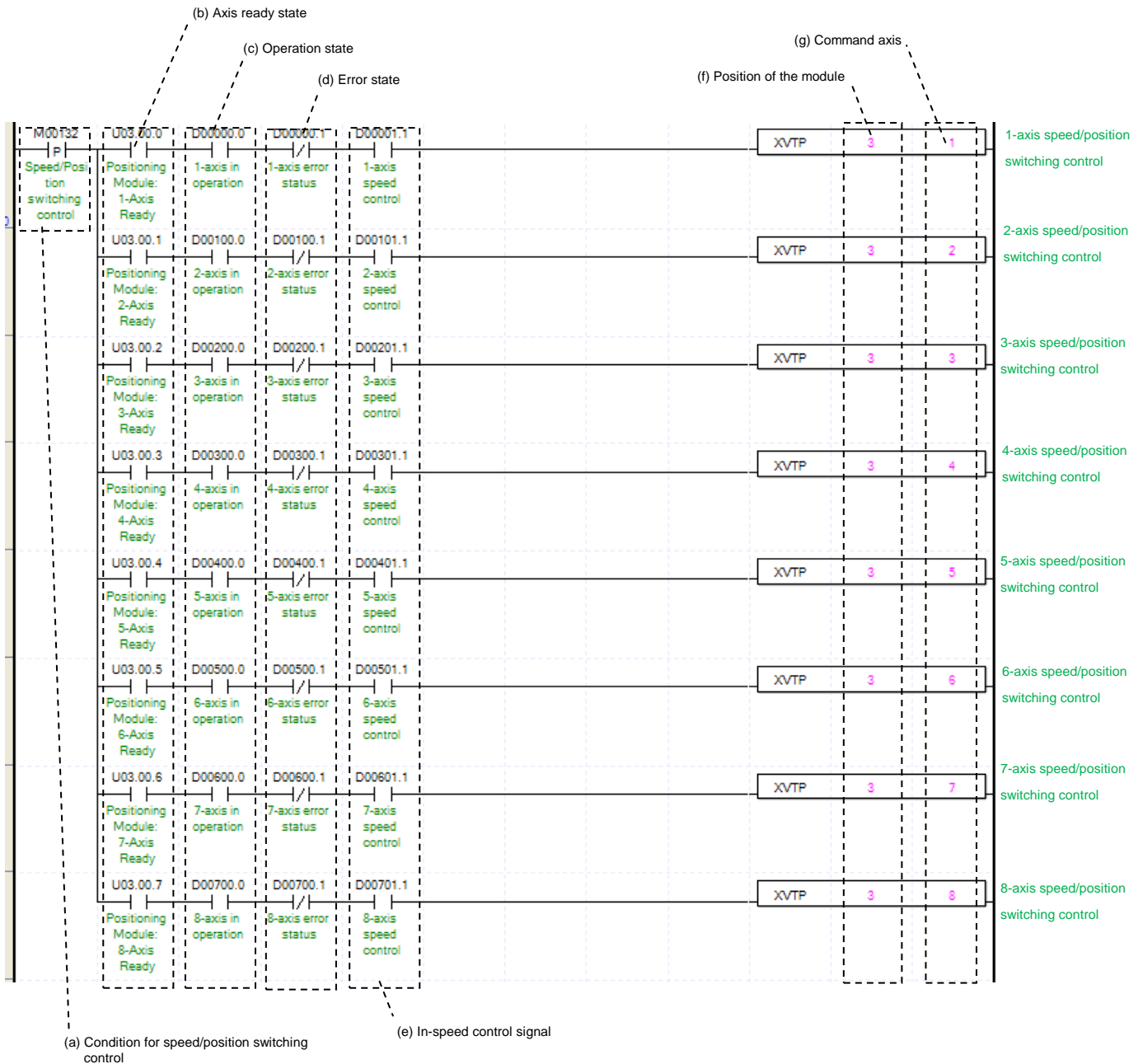

(a) Condition of Speed/Position Switching Control
 Condition of Speed/Position Switching Control Command (XVTP)

(b) Axis ready status

If communication between positioning module and servo drive is done, the signal corresponding to each signal will be on.

(c) Operating state by axis

According to exercise from “Chapter 8.1.2 Current State Reading,” it is a signal of “Operating” for each axis. It turns on when it is operating. Operating Data Setting can not be configured while it is running hence configuration will only be configured when it is not running. If you execute Speed/Position Switching Control while it is running, the “error 301” would be appeared.

(d) Error state for each axis

According to exercise from “Chapter 8.1.2 Current State Reading,” it is a signal of “Error state” for each axis. It turns on when an error occurred. Operation will only work when there is no error. If you want to operate a system regardless of errors, you can just inactivate the function.

(e) Signal from Speed Control by each Axis

According to exercise from “Chapter 8.1.2 Current State Reading,” it is a signal of “Speed Control state” for each axis. It turns on when it is operating. Speed/Position Switching Control Setting can only be configured while it is running. If you execute Speed/Position Switching Control while it is not running, the “error 302” would be appeared.

(f) Address of Positioning Module

In this example, Positioning Module installed at the slot no.3 of 0 bases.

(g) Axis of command execution

You can set an axis for Speed/Position Switching Control. XBF-PN04(8)B series supports for 4(8) axes. In the “execution of axis” from the configuration of Speed/Position Switching Control, you can set a value for axis 1 through 4(8) axis.

(h) For more information, reference of Speed/Position Switching Control is in the “Chapter 9.2.14.”

(5) Position-specified Speed/Position Control Switching

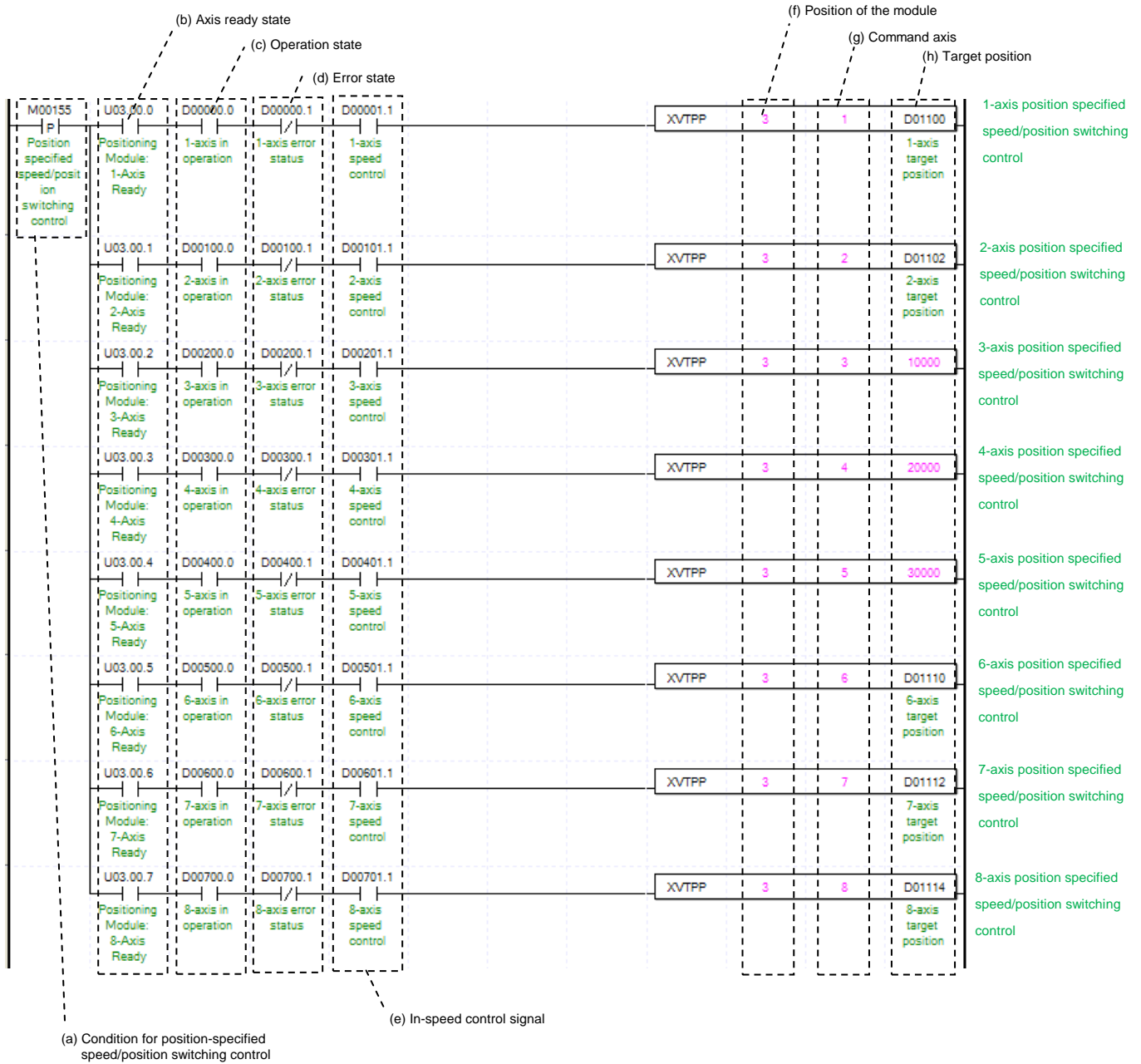

- (a) Condition to perform “position-specified speed/position switching control”
Condition to perform control command (XVTPP) for position-specified speed/position switching
- (b) Axis ready status
If communication between positioning module and servo drive is done, the signal corresponding to each signal will be on.
- (c) Operation state for each axis
In case that an example program of “8.1.2 Read Current State” is applied, it is a signal showing that each axis is “operating.” If a relevant axis is running, it becomes ‘On’. A condition has been set to make the control command for position specified speed/position switching valid only when the relevant axis is running. If the control command for position specified switching is carried out when the relevant axis is not running, No.301 Error will take place.

- (d) Error State for each axis
In case that an example program of "8.1.2 Read Current State" is applied, it is a signal showing "Error State" for each axis. If any error takes place, it becomes 'On'. A condition has been set to perform a control command only when there is no error with the relevant axis. If the user wants to execute a command regardless of the occurrence of errors, he/she may remove this condition.
- (e) Speed Control Signal for each axis
In case that an example program of "8.1.2 Read Current State" is applied, it is a signal showing each axis is "controlling its speed." If the relevant axis is running under speed control, it becomes 'On.' A condition has been set to make the control command for position specified speed/position switching control valid only when the relevant axis is in a speed control status. If the control command is carried out when the relevant axis is not in a speed control status, No.302 Error will take place.
- (f) Position of a module
For the example program above, it is assumed that positioning modules are installed on NO.0 Base and No. 3 Slot.
- (g) Axis to make a command
Decide an axis that will execute the control command. XBF-PN04(8)B can control up to 4(8) axis and assign 1 through 4(8) referring to 1-axis through 4(8)-axis for this item.
- (h) Transfer amount
After the control command for position specified speed/position control switching is executed, convert from speed control to position control and moves by transfer amount.
- (i) For details on the operation of position specified speed/position switching control, refer to "position specified speed/position switching control"

(6) Position/ Speed Switching Control

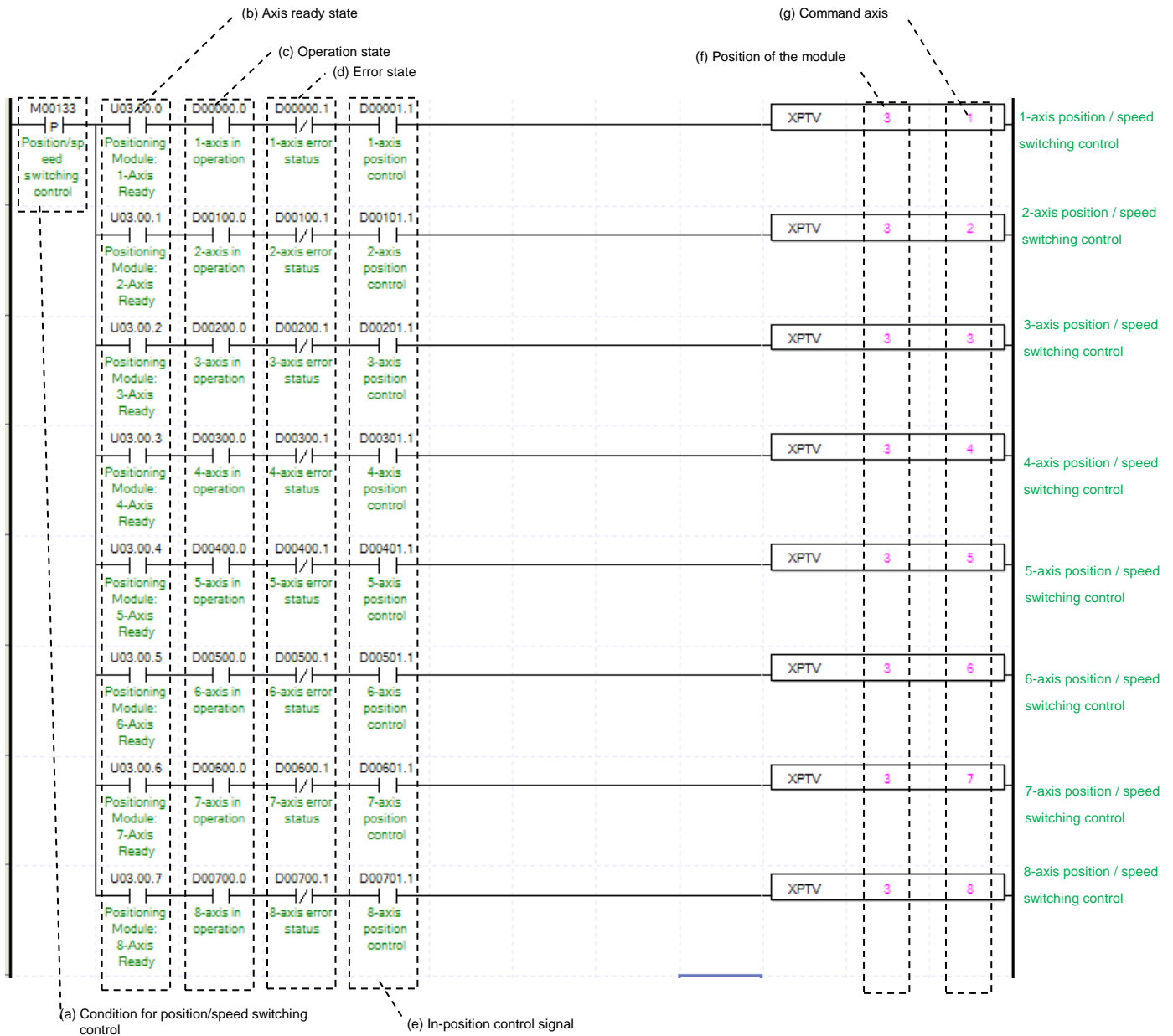

(a) Condition of Position/ Speed Switching Control

Condition of Position/ Speed Switching Control Command (XPTV)

(b) Axis ready status

If communication between positioning module and servo drive is done, the signal corresponding to each signal will be on.

(c) Operating state by axis

According to exercise from “Chapter 8.1.2 Current State Reading,” it is a signal of “Operating” for each axis. It turns on when it is operating. Operating Data Setting can not be configured while it is running hence configuration will only be configured when it is not running. If you execute Position/ Speed Switching Control while it is running, the “error 311” would be appeared.

(d) Error state for each axis

According to exercise from “Chapter 8.1.2 Current State Reading,” it is a signal of “Error state” for each axis. It turns on when an error occurred. Operation will only work when there is no error. If you want to operate a system regardless of errors, you can just inactivate the function.

- (e) Signal from Position Control by each Axis
According to exercise from “Chapter 8.1.2 Current State Reading,” it is a signal of “Position Control state” for each axis. It turns on when it is operating. Position/ Speed Switching Control Setting can only be configured while it is running. If you execute Position/Speed Switching Control while it is not running, the “error 317” would be appeared.
- (f) Address of Positioning Module
In this example, Positioning Module installed at the slot no.3 of 0 bases.
- (g) Axis of command execution
You can set an axis for Position/ Speed Switching Control. XBF-PN04(8)B can supports for 4(8) axes. In the “execution of axis” from the configuration of Position/ Speed Switching Control, you can set a value for axis 1 through 4(8) axis.
- (h) For more information, reference of Position/ Speed Switching Control is in the “Chapter 9.2.15.”

(7) Position/Torque Switching Control

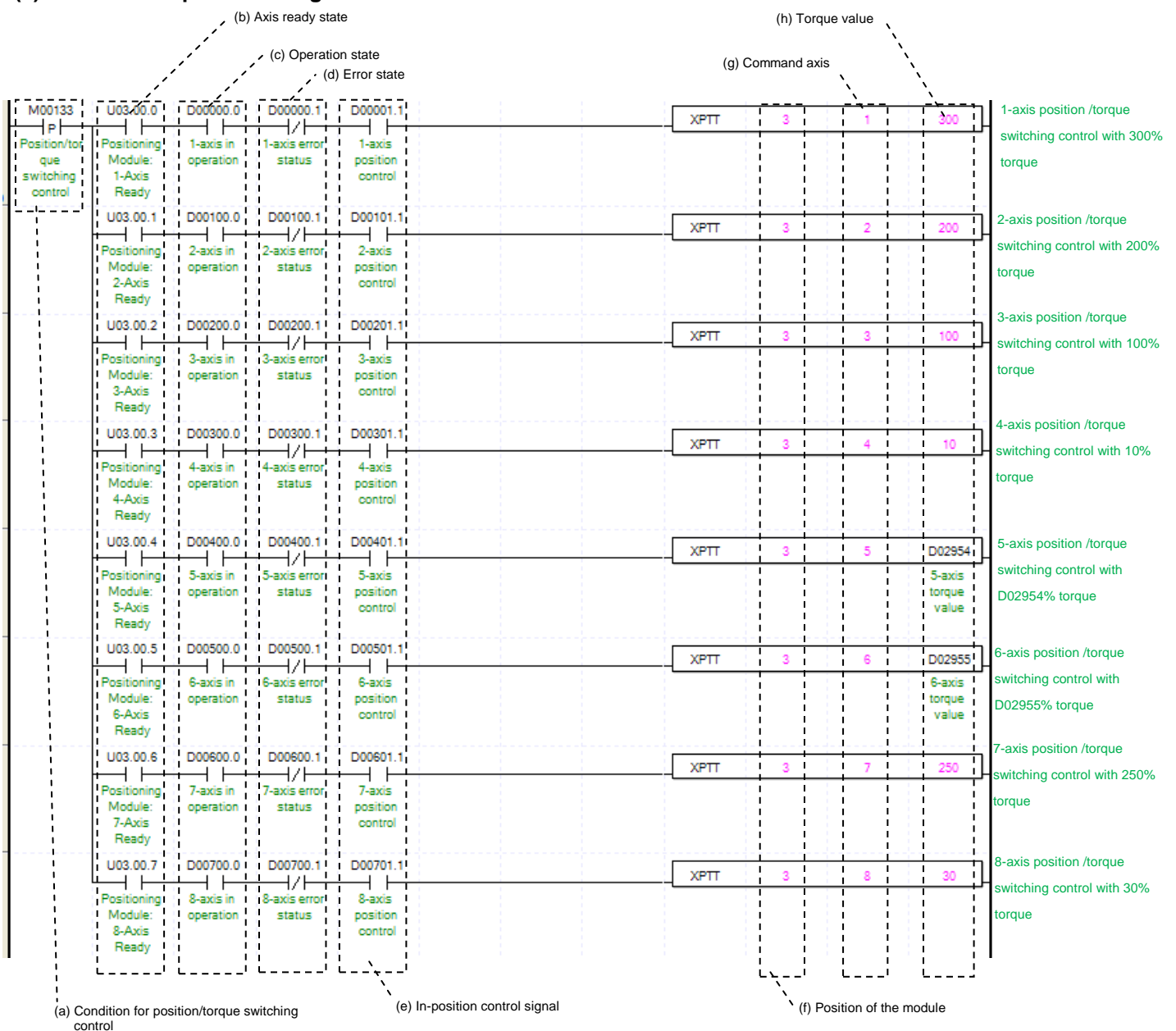

(a) Condition of Position/ Torque Switching Control

Condition of Position/ Torque Switching Control Command (XPTT)

(b) Axis ready status

If communication between positioning module and servo drive is done, the signal corresponding to each signal will be on.

(c) Operating state by axis

According to exercise from "Chapter 8.1.2 Current State Reading," it is a signal of "Operating" for each axis. It turns on when it is operating. Operating Data Setting can not be configured while it is running hence configuration will only be configured when it is not running. If you execute Position/ Torque Switching Control while it is running, the "error 561" would be appeared.

(d) Error state for each axis

According to exercise from "Chapter 8.1.2 Current State Reading," it is a signal of "Error state" for each axis. It turns on when an error occurred. Operation will only work when there is no error. If you want to operate a system regardless of errors, you can just inactivate the function.

(e) Signal from Position Control by each Axis

According to exercise from "Chapter 8.1.2 Current State Reading," it is a signal of "Position Control state" for each axis. It turns on when it is operating. Position/ Torque Switching Control Setting can only be configured while it is running. If you execute Position/Torque Switching Control while it is not running, the "error 317" would be appeared.

(f) Address of Positioning Module

In this example, Positioning Module installed at the slot no.3 of 0 bases.

(g) Axis of command execution

You can set an axis for Position/ Torque Switching Control. XBF-PN04(8)B series supports for 4(8) axes. In the "execution of axis" from the configuration of Position/ Torque Switching Control, you can set a value for axis 1 through 4(8) axis.

(h) It sets torque value. After position/torque switching command, it operates with that torque value. Range is -32768~32767%.

(i) For more information, reference of Position/ Torque Switching Control is in the "Chapter 9.2.15."

(8) Skip Operation

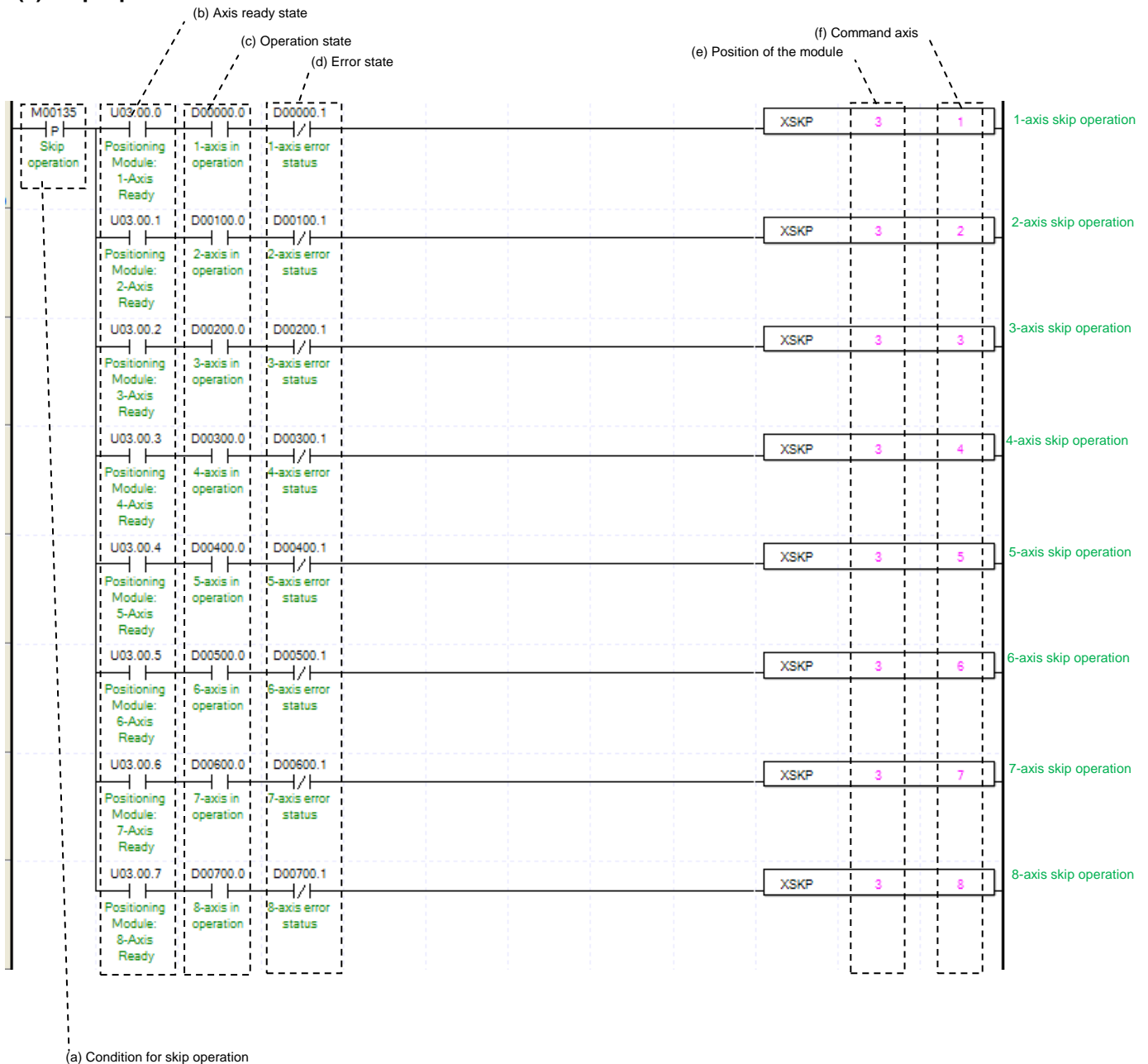

(a) Condition of Skip Operation

Condition of Skip Operation Command (XSKP) Once Skip Operation is executed, current operation step is stop and will go to operate with next step.

(b) Axis ready status

If communication between positioning module and servo drive is done, the signal corresponding to each signal will be on.

(c) Operating state by axis

According to exercise from “Chapter 8.1.2 Current State Reading,” it is a signal of “Operating” for each axis. It turns on when it is operating. Operating Data Setting can not be configured while it is running hence configuration will only be configured when it is not running. If you execute Skip Operation while it is running, the “error 331” would be appeared.

(d) Error state for each axis

According to exercise from “Chapter 8.1.2 Current State Reading,” it is a signal of “Error state” for each axis. It turns on when an error occurred. Operation will only work when there is no error. If you want to operate a system regardless of errors, you can just inactivate the function.

(e) Address of Positioning Module

In this example, Positioning Module installed at the slot no.3 of 0 bases.

(f) Axis of command execution

You can set an axis for Skip Operation. XBF-PN04(8)B can supports for 4(8) axes. In the “execution of axis” from the configuration of Skip Operation, you can set a value for axis 1 through 4(8) axis.

(g) For more information, reference of Skip Operation is in the “Chapter 9.5.3”.

(9) Continuous Operation

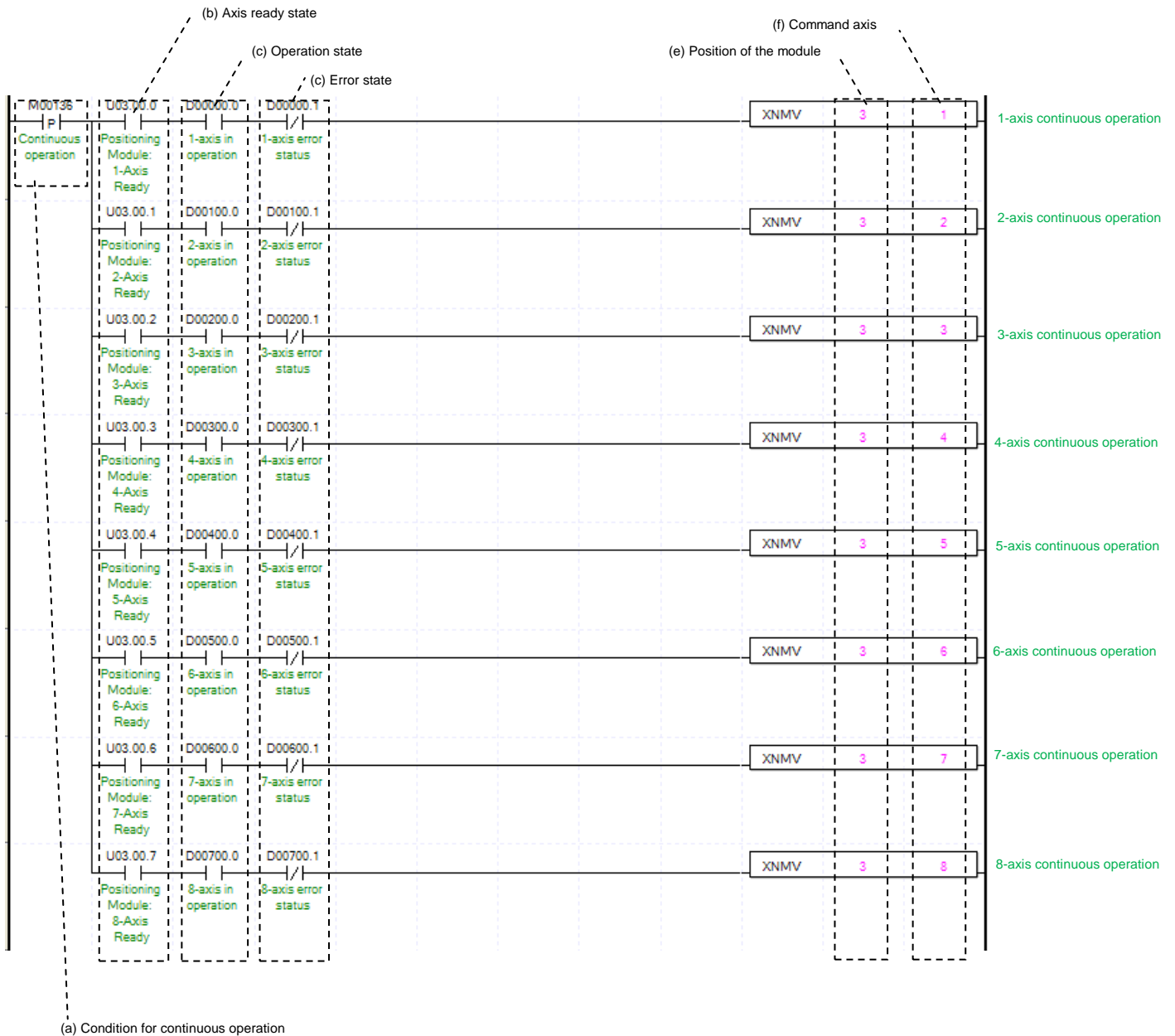

(a) Condition of Continuous Operation

Condition of Continuous Operation Command (XNMV). Once Continuous Operation is executed, current operation step and next operation step would be operated continuously.

(b) Axis ready status

If communication between positioning module and servo drive is done, the signal corresponding to each signal will be on.

(c) Operating state by axis

According to exercise from "Chapter 8.1.2 Current State Reading," it is a signal of "Operating" for each axis. It turns on when it is operating. Operating Data Setting can not be configured while it is running hence configuration will only be configured when it is not running. If you execute Continuous Operation while it is running, the "error 391" would be appeared.

(d) Error state for each axis

According to exercise from "Chapter 8.1.2 Current State Reading," it is a signal of "Error state" for each axis. It turns on when an error occurred. Operation will only work when there is no error. If you want to operate a system regardless of errors, you can just inactivate the function.

(e) Address of Positioning Module

In this example, Positioning Module installed at the slot no.3 of 0 bases.

(f) Axis of command execution

You can set an axis for Continuous Operation. XBF-PN04(8)B can supports for 4(8) axes. In the "execution of axis" from the configuration of Continuous Operation, you can set a value for axis 1 through 4(8) axis.

(g) For more information, reference of Continuous Operation is in the "Chapter 9.5.2".

(10) Current Step Change (Start Step Number Change)

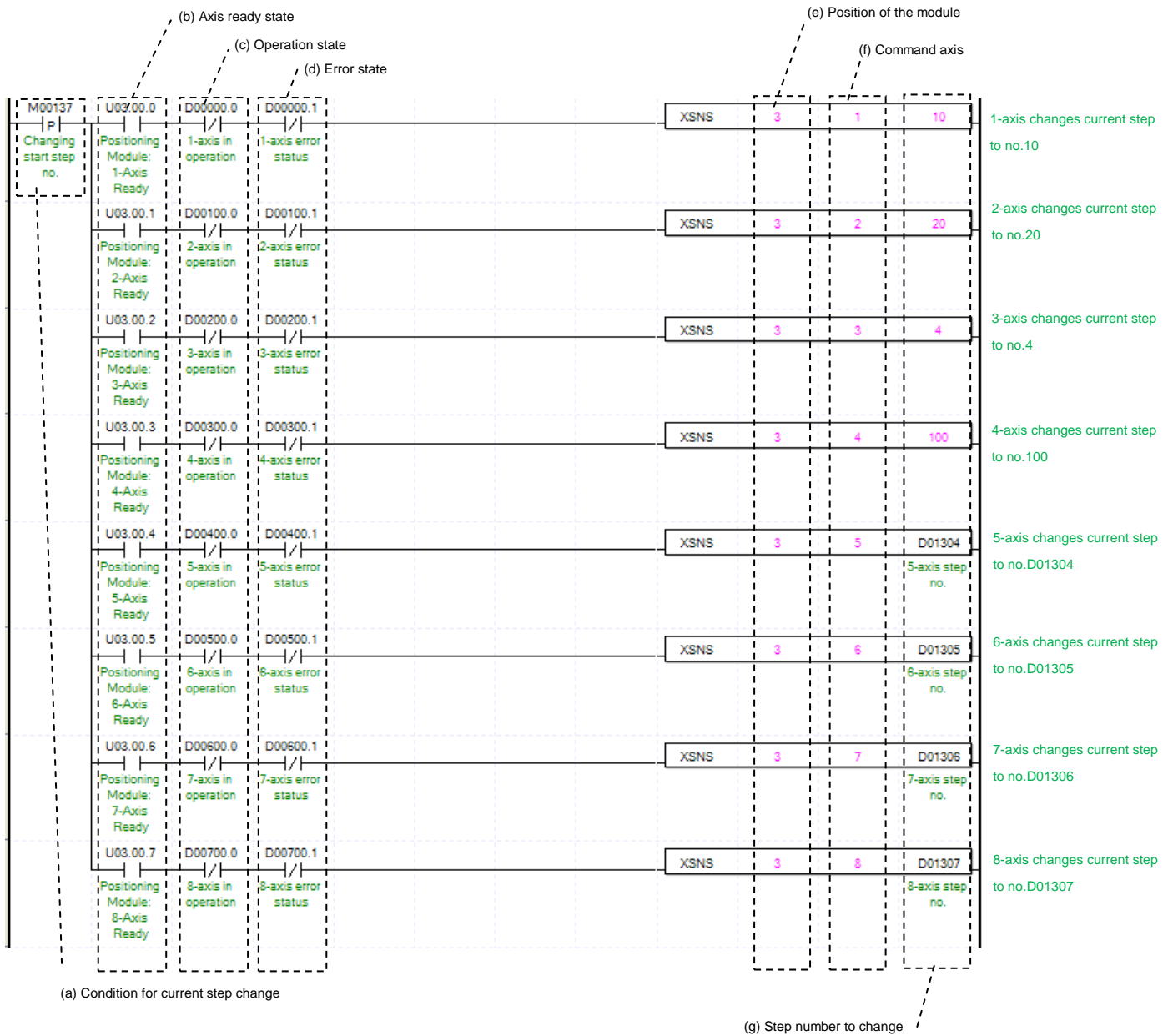

- (a) Condition of Current Step Change
Condition of Current Step Change Command (XSNS). Once Current Step Change is executed, current operation step will move set step.
- (b) Axis ready status
If communication between positioning module and servo drive is done, the signal corresponding to each signal will be on.
- (c) Operating state by axis
According to exercise from "Chapter 8.1.2 Current State Reading," it is a signal of "Operating" for each axis. It turns on when it is operating. Operating Data Setting can not be configured while it is running hence configuration will only be configured when it is not running. If you execute Current Step Change while it is running, the "error 441" would be appeared.

- (d) Error state for each axis
According to exercise from “Chapter 8.1.2 Current State Reading,” it is a signal of “Error state” for each axis. It turns on when an error occurred. Operation will only work when there is no error. If you want to operate a system regardless of errors, you can just inactivate the function.
- (e) Address of Positioning Module
In this example, Positioning Module installed at the slot no.3 of 0 bases.
- (f) Axis of command execution
You can set an axis for Current Step Change. XBF-PN04(8)B can supports for 4(8) axes. In the “execution of axis” from the configuration of Current Step Change, you can set a value for axis 1 through 4(8) axis.
- (g) Change Step Number
Set change step number by Current Step Change. XBF-PN04B/PN08B support 400 step operation data for each Axis. Therefore, the range of step number setting of Current Step Change is 1~400.
- (h) For more information, reference of Current Step Change is in the “Chapter 9.5.9.”

(11) Repeat Step No. Change

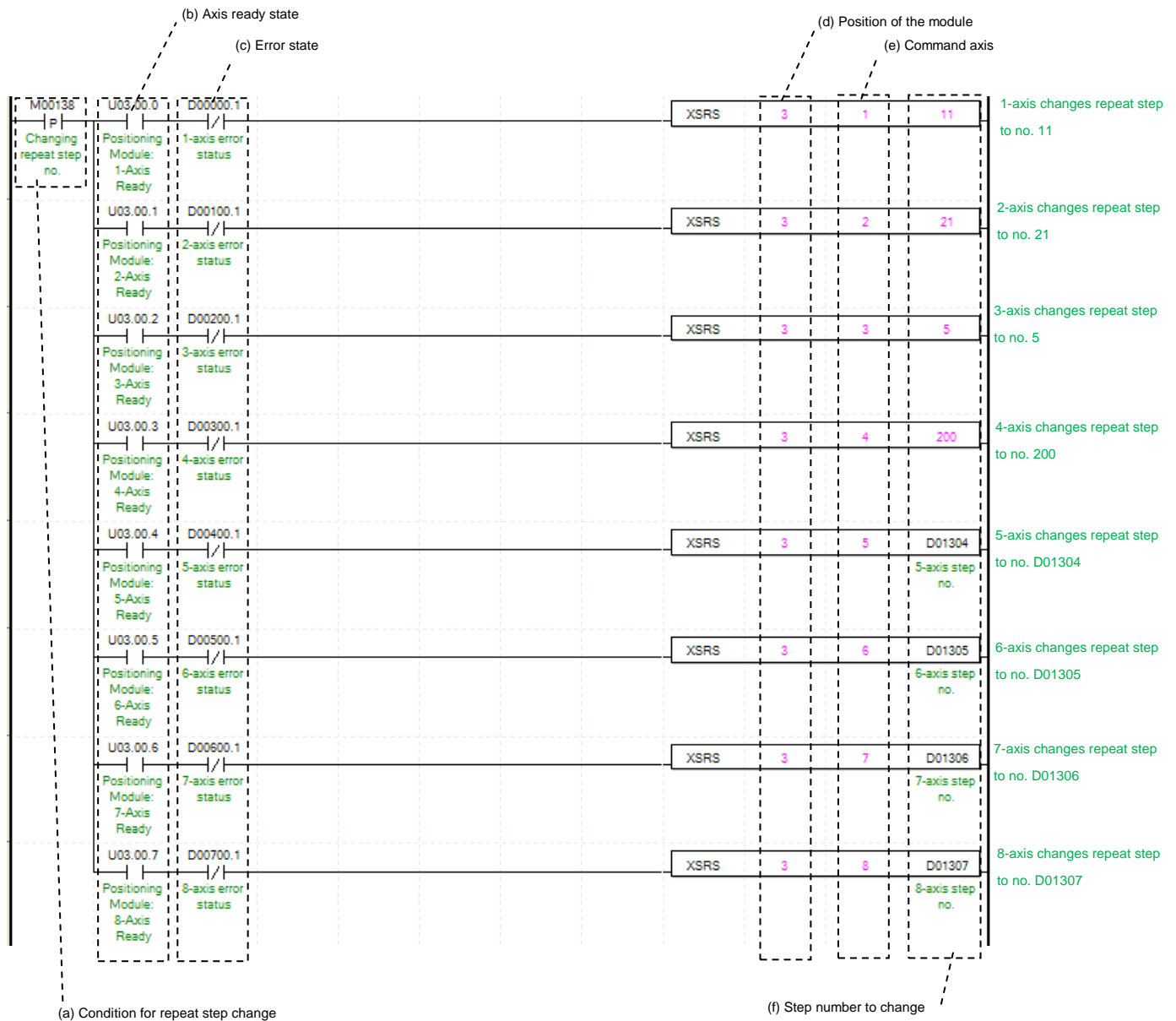

(a) Condition of Repeat Step No. Change

Condition of Repeat Step No. Change Command (XSRS). Once Repeat Step No. Change is executed, current operation step will move set step. It will execute an operation when set of Operation Method is "Repeat."

(b) Axis ready status

If communication between positioning module and servo drive is done, the signal corresponding to each signal will be on.

(c) Error state for each axis

According to exercise from "Chapter 8.1.2 Current State Reading," it is a signal of "Error state" for each axis. It turns on when an error occurred. Operation will only work when there is no error. If you want to operate a system regardless of errors, you can just inactivate the function.

(d) Address of Positioning Module

In this example, Positioning Module installed at the slot no.3 of 0 bases.

(e) Axis of command execution

You can set an axis for Repeat Step No. Change. XBF-PN04(8)B can supports for 4(8) axes. In the "execution of axis" from the configuration of Repeat Step No. Change, you can set a value for axis 1 through 4(8) axis.

(f) Change Step Number

Set change step number by Current Step Change. XBF-PN04B/PN08B support 400 step operation data for each Axis.

Therefore, the range of step number setting of Current Step Change is 1~400.

(g) For more information, reference of Repeat Step No. Change is in the "Chapter 9.5.10."

(12) Current Position Preset

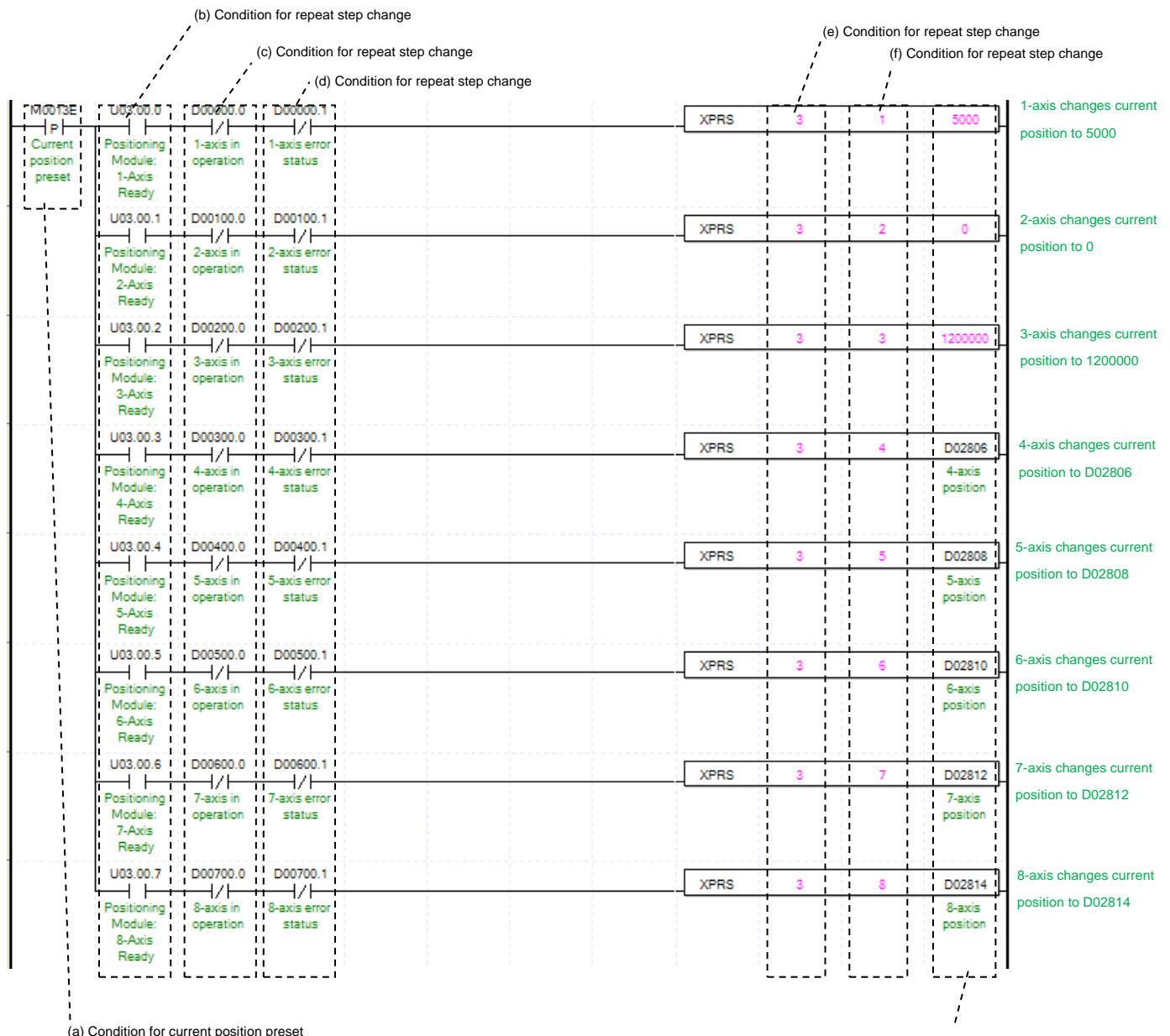

(a) Condition of Current Position Preset

Condition of Current Position Preset Command (XPRS). Once Current Position Preset is executed, current operation step will move to set step. If the origin has not set yet, the origin would be set to origin decided.

(b) Axis ready status

If communication between positioning module and servo drive is done, the signal corresponding to each signal will be on.

(c) Operating state by axis

According to exercise from "Chapter 8.1.2 Current State Reading," it is a signal of "Operating" for each axis. It turns on when it is operating. Operating Data Setting can not be configured while it is running hence configuration will only be configured when it is not running. If you execute Current Position Preset while it is running, the "error 451" would be appeared.

(d) Error state for each axis

According to exercise from "Chapter 8.1.2 Current State Reading," it is a signal of "Error state" for each axis. It turns on when an error occurred. Operation will only work when there is no error. If you want to operate a system regardless of errors, you can just inactivate the function.

(g) Condition for repeat step change

(e) Address of Positioning Module

In this example, Positioning Module installed at the slot no.3 of 0 bases.

(f) Axis of command execution

You can set an axis for Current Position Preset. XBF-PN04(8)B series supports for 4(8) axes. In the “execution of axis” from the configuration of Current Position Preset, you can set a value for axis 1 through 4(8) axis.

(g) Change Current Position

Set change current position by Current Position Preset. Unit follows the value from “Unit” of basic parameter.

(h) For more information, reference of Current Position Preset is in the “Chapter 9.5.7.”

(13) Encoder Preset

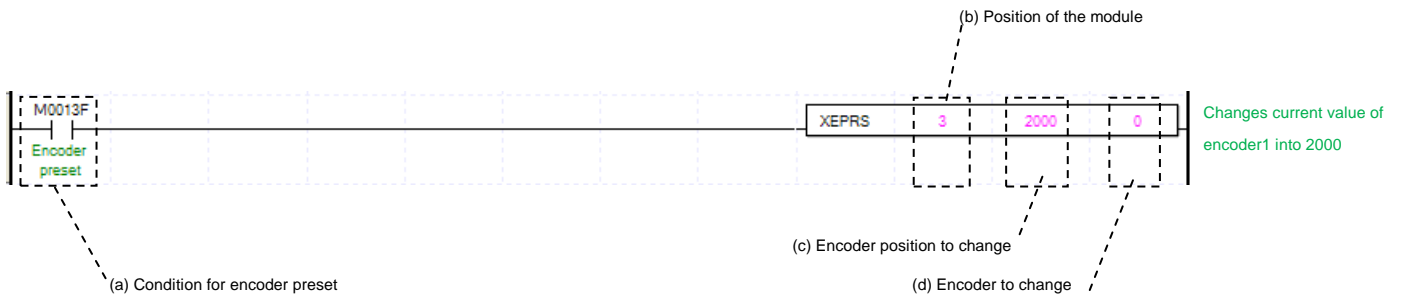

(a) Condition of Encoder Preset

Condition of Encoder Preset Command (XEPRS). Once Encoder Preset is executed, current operation step will move to set step.

(b) Address of Positioning Module

In this example, Positioning Module installed at the slot no.3 of 0 bases.

(c) Changing Encoder Position

Set for Changing Encoder Position

(d) Changing Encoder

Set Changing Encoder to execute a preset. “0” means “Encoder1”.

(e) For more information, reference of Encoder Preset is in the “Chapter 9.5.8.”

(14) Reset Latch

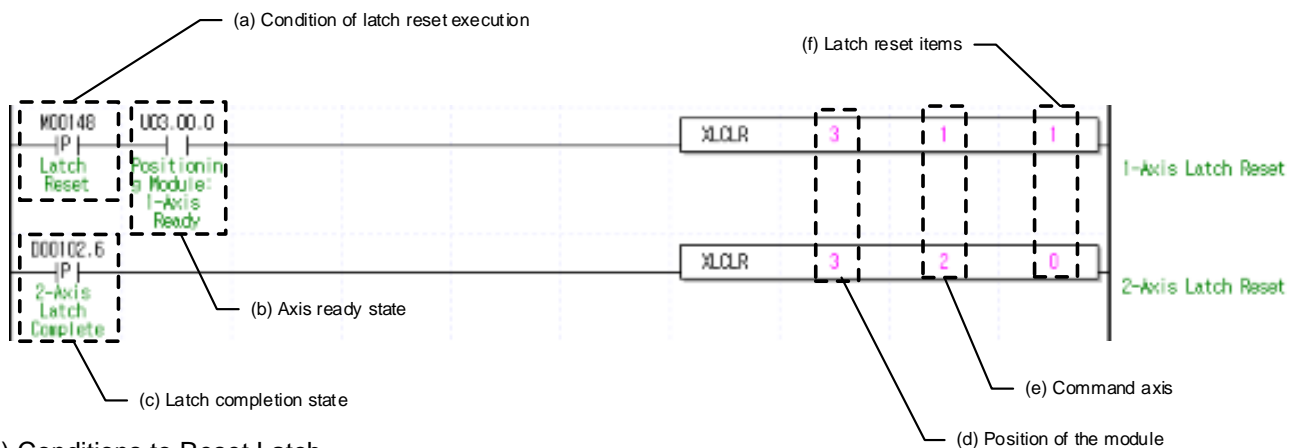

(a) Conditions to Reset Latch

Conditions to implement the Reset Latch command (XLCLR). In case of Axis 1, the Reset Latch command is implemented as soon as M00148 (Reset Latch) is On after the axis is connected to the network.

(b) Preparation for each axis

If communication with the servo drive connected to positioning module is normally conducted, the corresponding signal to the connected axis is On. In the example program, the Reset Latch command is implemented as soon as M00148(Reset Latch) is On after the axis connected with servo since Axis 1 preparation state (Uxx.00.0) is used.

(c) Latch Completion

It is the state of "Latch Completion" when an example program of "8.1.2 Read the Current State." It is on when latch is completed once external latch command signal of the relevant axis is inputted. In case of Axis 2, the Reset Latch item is implemented as soon as D00102.6 (Latch Completion state) is On. To read latch data every time when latch is completed upon the input of the axis's external latch command signal, program to set latch completion as a condition for the Reset Latch command after implementing the Latch Position Data Read command.

(d) Address of Positioning Module

In this example, Positioning Module installed at the slot no.3 of 0 bases.

(e) Axis of command execution

You can set an axis for Reset Latch. XBF-PN04(8)B series supports for 4(8) axes. In the "execution of axis" from the configuration of Reset Latch, you can set a value for axis 1 through 4(8) axis.

(f) Latch Reset item

The following items are reset according to the Latch Reset item.

0: Reset the state when latch is completed

1: Latch position data Reset and the latch completion state Reset

In the example program, latch position data and latch completion are reset for Axis 1 and only latch completion is reset for Axis 2 when implementing the Latch Reset command.

Remark

Two latch modes are supported. In case that a single trigger from two latch modes is set, ensure latch function to perform through the second touch probe 1 signal after the first touch probe 1 signal is inputted and latched and latch reset command is completed.

That is, in latch single trigger mode, the Reset Latch command will execute a function to activate the next latch trigger after the touch probe 1 signal is inputted and the latch location is saved.

(Even if the Set Latch command is re-executed after it is set as latch permission, it will work in the same way)

(15) Set Latch

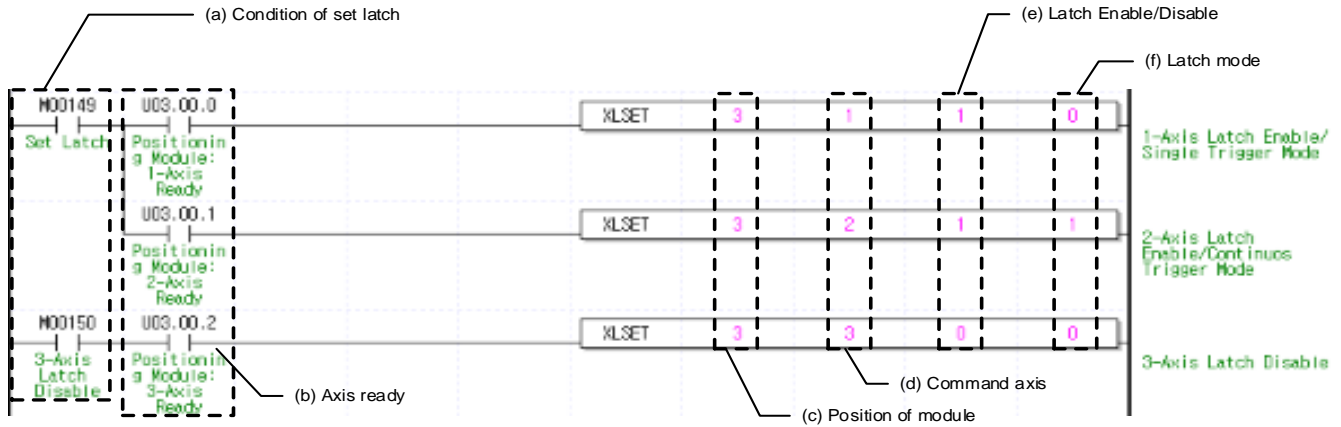

(a) Conditions to Set Latch

Conditions to implement the Latch Set command (XLSET). The Set Latch command is implemented on Axis 1 and 2 as soon as M00149(Set Latch) is On after the axis is connected to the network and it is implemented on Axis 3 as soon as M00150(3-Axis Latch Disable) is On.

(b) Preparation for each axis

If communication with the servo drive connected to the positioning module is normally conducted, the corresponding signal to the connected axis is On. In the example program, the Set Latch command is implemented as soon as the condition to Set Latch is On after the axis connected with servo since Axis 1 Ready (Uxx.00.0) is used.

(c) Address of Positioning Module

In this example, Positioning Module installed at the slot no.3 of 0 bases.

(d) Axis of command execution

You can set an axis for Set Latch. XBF-PN04(8)B series supports for 4(8) axes. In the “execution of axis” from the configuration of Set Latch, you can set a value for axis 1 through 4(8) axis, can be set to “Axis to which Command is executed” item of the Latch Set command(XLSET).

(e) Latch Enable/Disable item

Actions according to the designated Latch Enable/Disable item are as following:

- 0: latch disable
- 1: latch enable

In the example program, latch is enabled for Axis 1 and 2 while it is disabled for Axis 3.

(f) Latch Mode Item

Actions according to the designated latch mode item are as following:

- 0: Single trigger (The current position latch is available only the touch probe 1 signal inputted at first after latch is permitted)
- 1: Continuous trigger (The current position latch is available at every touch probe 1 signal after latch is permitted)

In the example program, Axis 1 is set in the single trigger mode while Axis 2 is set in the continuous trigger mode when implementing the Set Latch command.

8.1.8 Error

(1) Error Reset

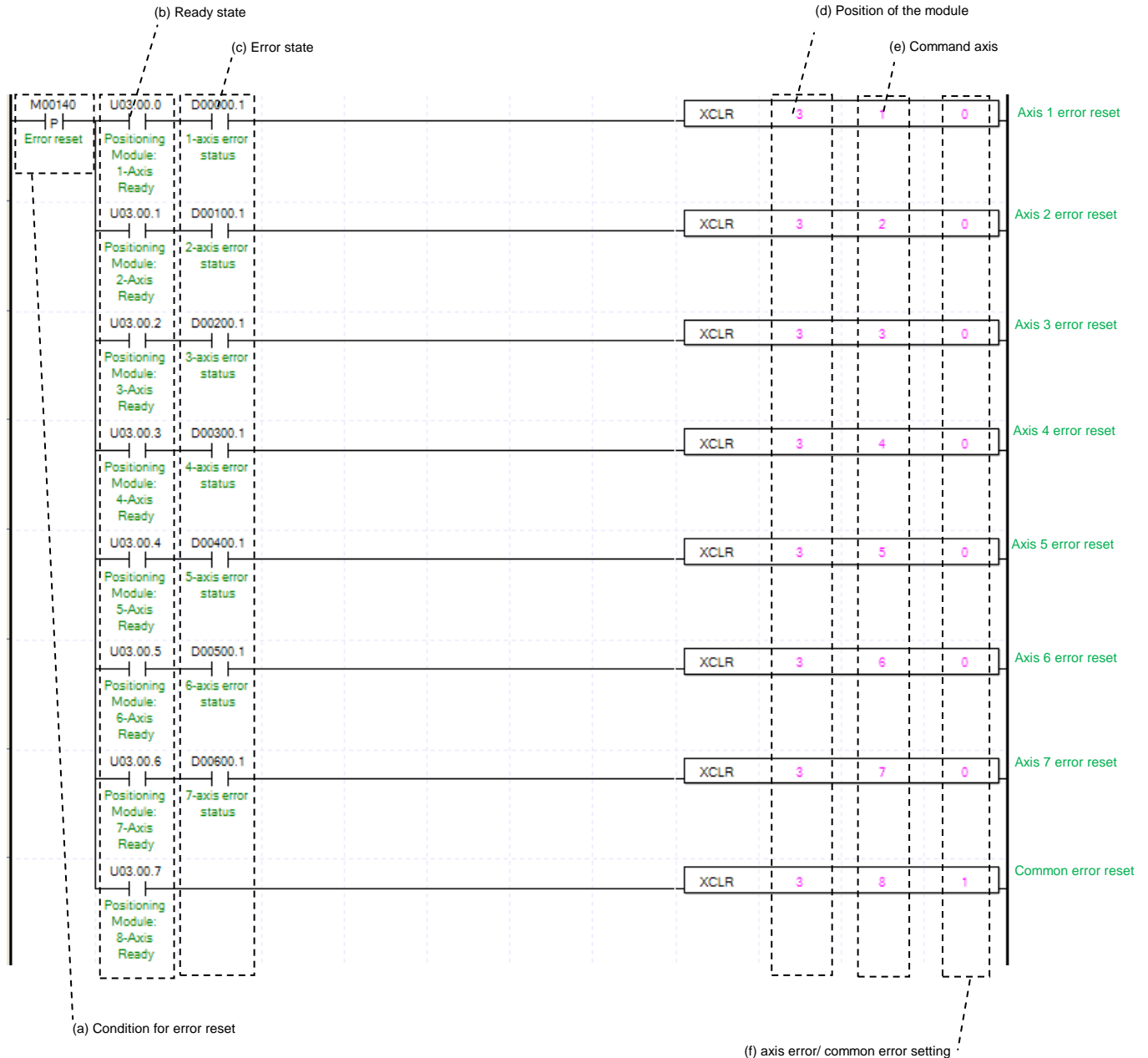

(a) Condition of Error Reset

Condition of Error Reset Command (XCLR). Once Error Reset is executed, it erases errors of module form each axis.

(b) Axis ready status

If communication between positioning module and servo drive is done, the signal corresponding to each signal will be on.

(c) Error state for each axis

According to exercise from “Chapter 8.1.2 Current State Reading,” it is a signal of “Error state” for each axis. It turns on when an error occurred. Operation will only work when there is no error. If you want to operate a system regardless of errors, you can just inactivate the function.

(d) Address of Positioning Module

In this example, Positioning Module installed at the slot no.3 of 0 bases.

(e) Axis of command execution

You can set an axis for Error Reset. XBF-PN04(8)B can supports for 4(8) axes. In the “execution of axis” from the configuration of Error Reset, you can set a value for axis 1 through 4(8) axis.

(f) Error setting of Error/Common by axis

If this is set as “0”, it will delete the axis error occurred during execution of command and if this is set as “1”, it will delete the error commonly occurred at common parameter or communication error.

(2) Error History Reset

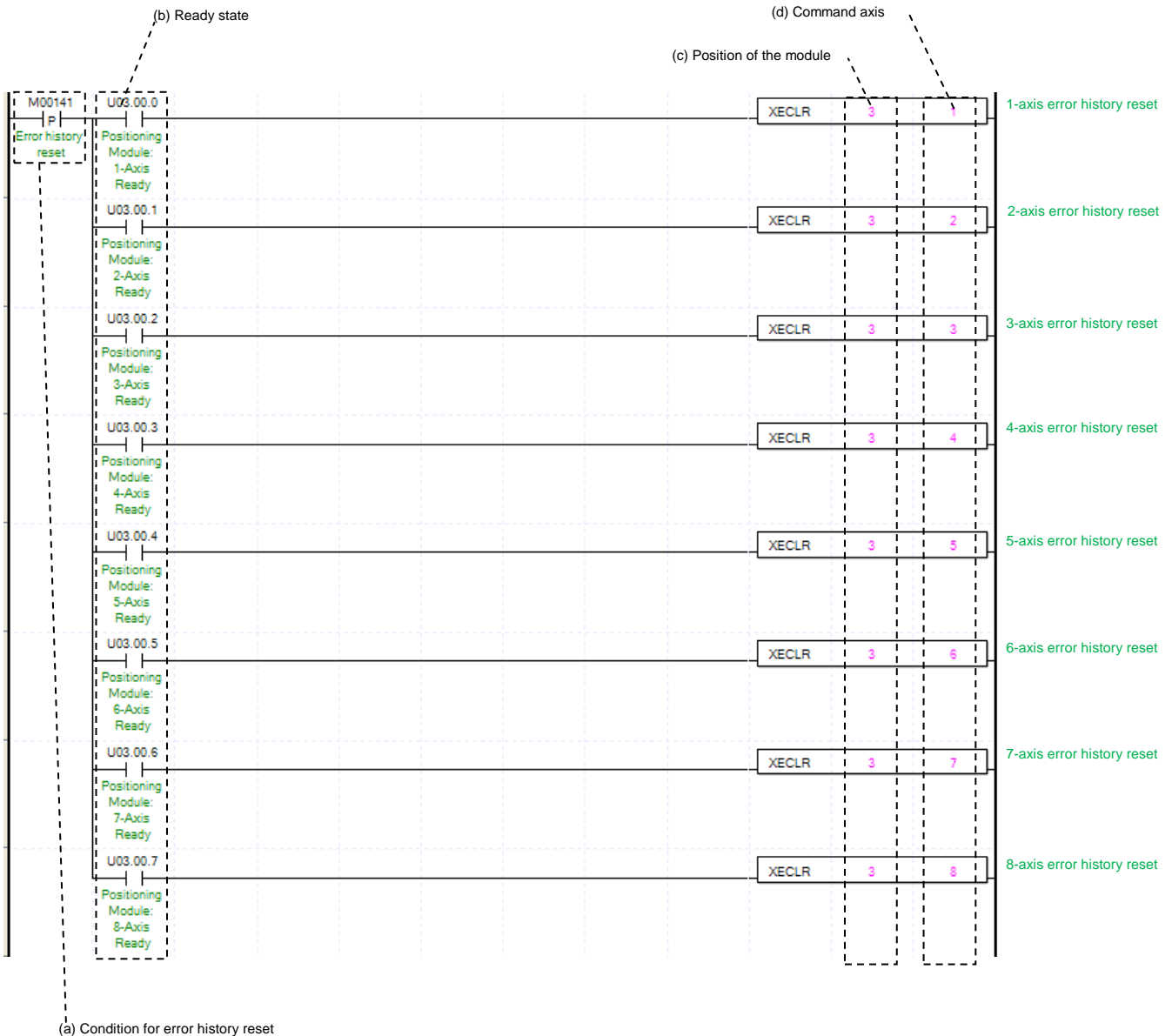

(a) Condition of Error History Reset

Condition of Error History Reset Command (XECLR). Once Error Reset is executed, it erases history of generated errors of module. XBF-PN04B/PN08B has ten error histories by each axis. It will be saved to MRAM, remain still even there is no power.

(b) Axis ready status

If communication between positioning module and servo drive is done, the signal corresponding to each signal will be on.

(c) Address of Positioning Module

In this example, Positioning Module installed at the slot no.3 of 0 bases.

(d) Axis of command execution

You can set an axis for Error History Reset. XBF-PN04(8)B can supports for 4(8) axes. In the “execution of axis” from the configuration of Error History Reset, you can set a value for axis 1 through axis 4(8).

(3) Servo Driver Error Reset

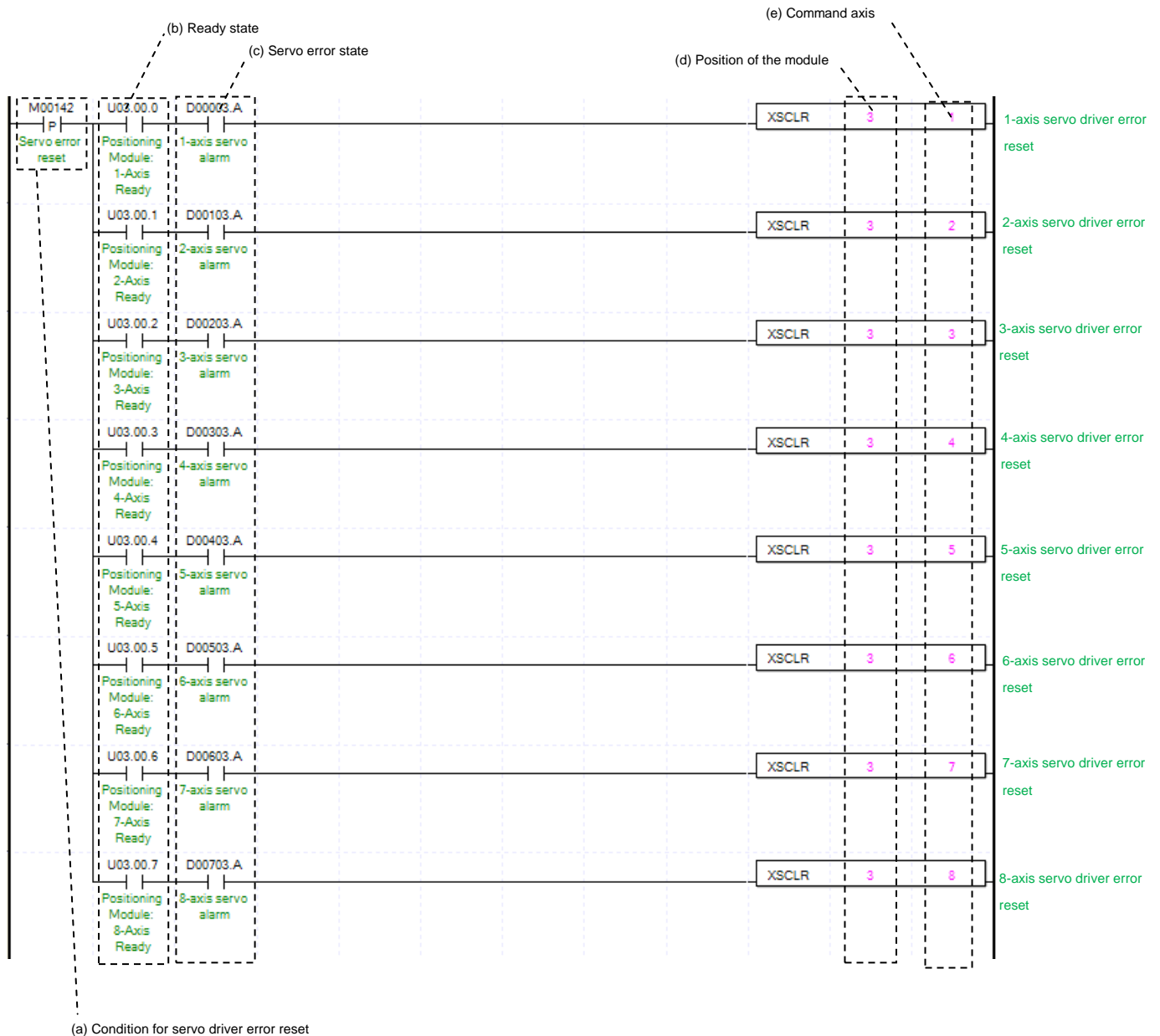

(a) Condition of Servo Driver Error Reset

Condition of Servo Driver Error Reset Command (XSCLR). Once Error Reset is executed, it erases errors of the servo driver connected to corresponding axis. If you execute this command without removing the cause of error, error of the servo driver may remain.

(b) Axis ready status

If communication between positioning module and servo drive is done, the signal corresponding to each signal will be on.

(c) Servo error state for each axis

According to exercise from “Chapter 8.1.2 Current State Reading,” it is a signal of “Servo error state” for each axis. It turns on when an servo error occurred. Operation will only work when there is servo error. If you want to operate a system regardless of errors, you can just inactivate the function.

(d) Address of Positioning Module

In this example, Positioning Module installed at the slot no.3 of 0 bases.

(e) Axis of command execution

You can set an axis for Servo Driver Error Reset. XBF-PN04(8)B can supports for 4(8) axes. In the “execution of axis” from the configuration of Servo Driver Error Reset, you can set a value for axis 1 through axis 4(8).

(4) Servo Driver Error History Reset

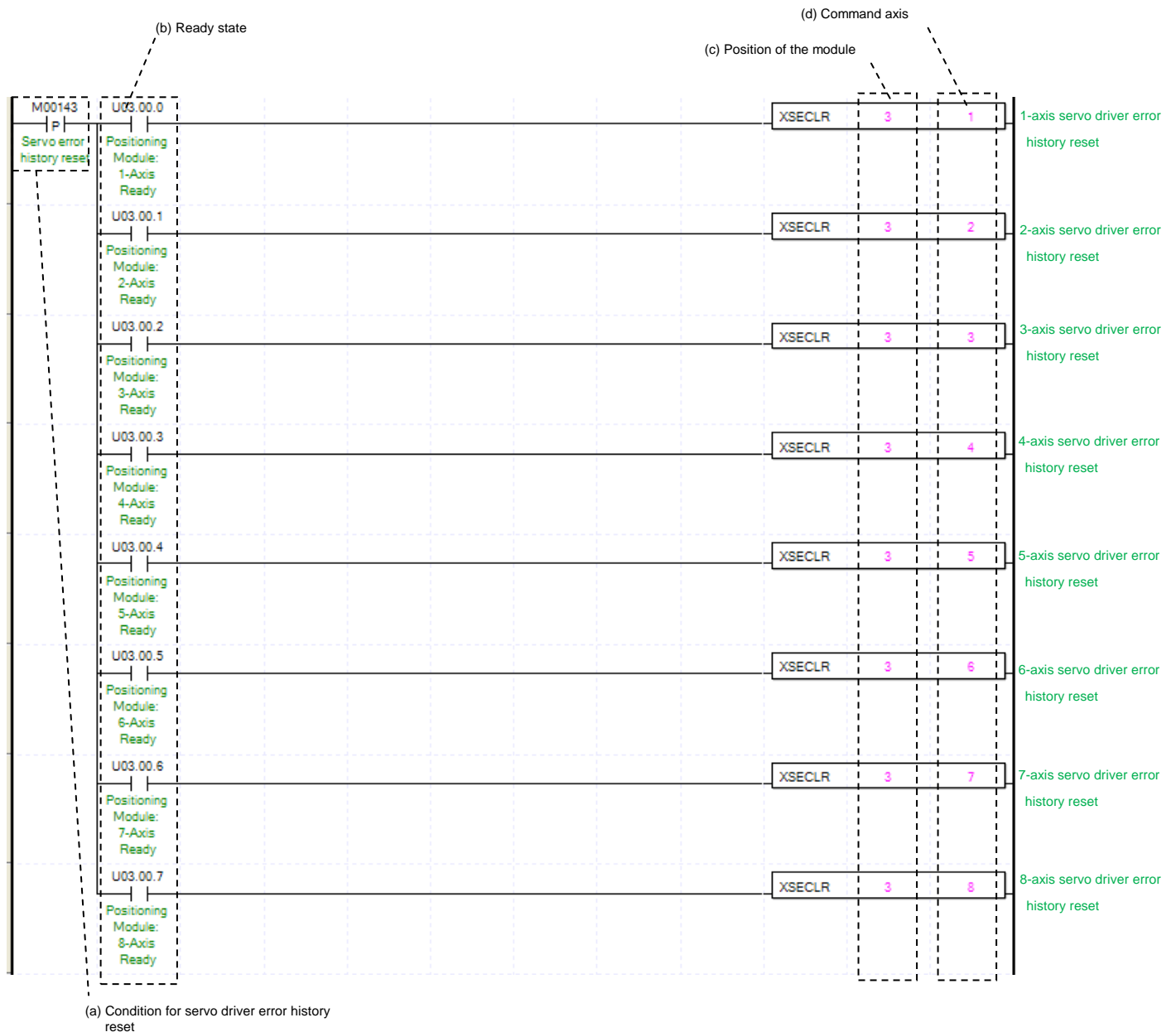

(a) Condition of Servo Error History Reset

Condition of Servo Error History Reset Command (XSECLR). Once Error Reset is executed, it erases history of generated errors of servo driver. Servo driver has ten error histories by each axis. .

(b) Axis ready status

If communication between positioning module and servo drive is done, the signal corresponding to each signal will be on.

(c) Address of Positioning Module

In this example, Positioning Module installed at the slot no.3 of 0 bases.

(d) Axis of command execution

You can set an axis for Servo Error History Reset. XBF-PN04(8)B can supports for 4(8) axes. In the “execution of axis” from the configuration of Servo Error History Reset, you can set a value for axis 1 through axis 4(8).

8.1.9 Program related with the Servo Parameter

(1) Servo driver parameter read

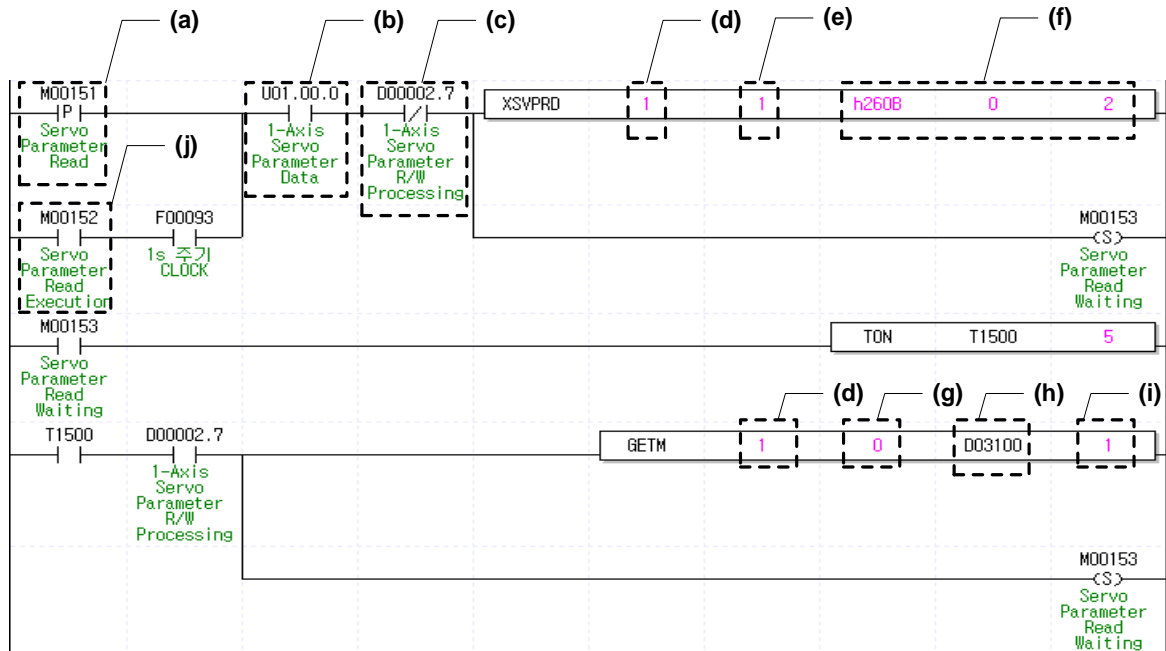

- (a) Condition of Servo Parameter Read
Condition of Servo Parameter Read Command (XSVPRD). Once "Servo Parameter Read" is executed, it saves to read parameter object value of the servo driver into addressed memory area.
- (b) Axis ready status
If communication between positioning module and servo drive is done, the signal corresponding to each signal will be On.
- (c) Axis servo parameter R/W processing status
Display execution status of Servo drive parameter read/write command or memory save command. Set command executed during servo drive read/write do not executing.
- (d) Position of the module
In this example, Positioning Module installed at the slot no.1 of 1 bases.
- (e) Axis of command execution
You can set an axis for Parameter Read. XBF-PN04(8)B can supports for 4(8) axes. In the "execution of axis" from the configuration of Parameter Read, you can set a value for axis 1 through axis 4(8).
- (f) Set servo driver parameter
Set index number, SubIndex number, Size of reading parameter object in servo drive parameters. In this example, read servo drive internal temperature of specified by h2610:00 with 2 byte size.
- (g) Address of common data area
If you execute "Servo parameter read", the data read from positioning module will be saved in common area. In order to save in device for using in program, use GETM or GETMP command as program example after executing "Servo parameter read" command. common data common area address can be used to GETM or GETMP command as follows.

Address	Description
0	1axis servo parameter Index (high) / SubIndex (low)
1	1axis servo parameter data value
2	2axis servo parameter Index (high) / SubIndex (low)
3	2axis servo parameter data value
4	3axis servo parameter Index (high) / SubIndex (low)
5	3axis servo parameter data value
6	4axis servo parameter Index (high) / SubIndex (low)
7	4axis servo parameter data value
8	5axis servo parameter Index (high) / SubIndex (low)
9	5axis servo parameter data value
10	6axis servo parameter Index (high) / SubIndex (low)
11	6axis servo parameter data value
12	7axis servo parameter Index (high) / SubIndex (low)
13	7axis servo parameter data value
14	8axis servo parameter Index (high) / SubIndex (low)
15	8axis servo parameter data value

(h) Save device of common data

Set starting address of the device to be saved after read data. In the example, saves data into D03100.

(i) Data size

It set up size of data to read from common data area. In the example, reads 2 DWORD.

In the example, saves in D03100 device to read data of h2610 (Inner temperature of servo driver) parameter after executed the Servo driver parameter read command. It saves the Index/SubIndex and data value of servo parameter in d03100 and D03102 at after 5ms executing servo parameter read command when "1-Axis Servo Parameter R/W Processing" is off state.

You can read the data of servo parameter as follows.

After executing "servo parameter read" command, you have to execute GETM command minimum 4ms to read updated data in common area.

(j) Cyclic read execution condition of servo parameter

When servo parameter cyclic read contact is 'On', 'Servo driver parameter read' command execute once per second. Periodically, you can monitor the servo driver parameters. If cycle is set too fast, 'Servo driver parameter read' command executed duplicate errors can occur.

(2) Servo driver parameter write

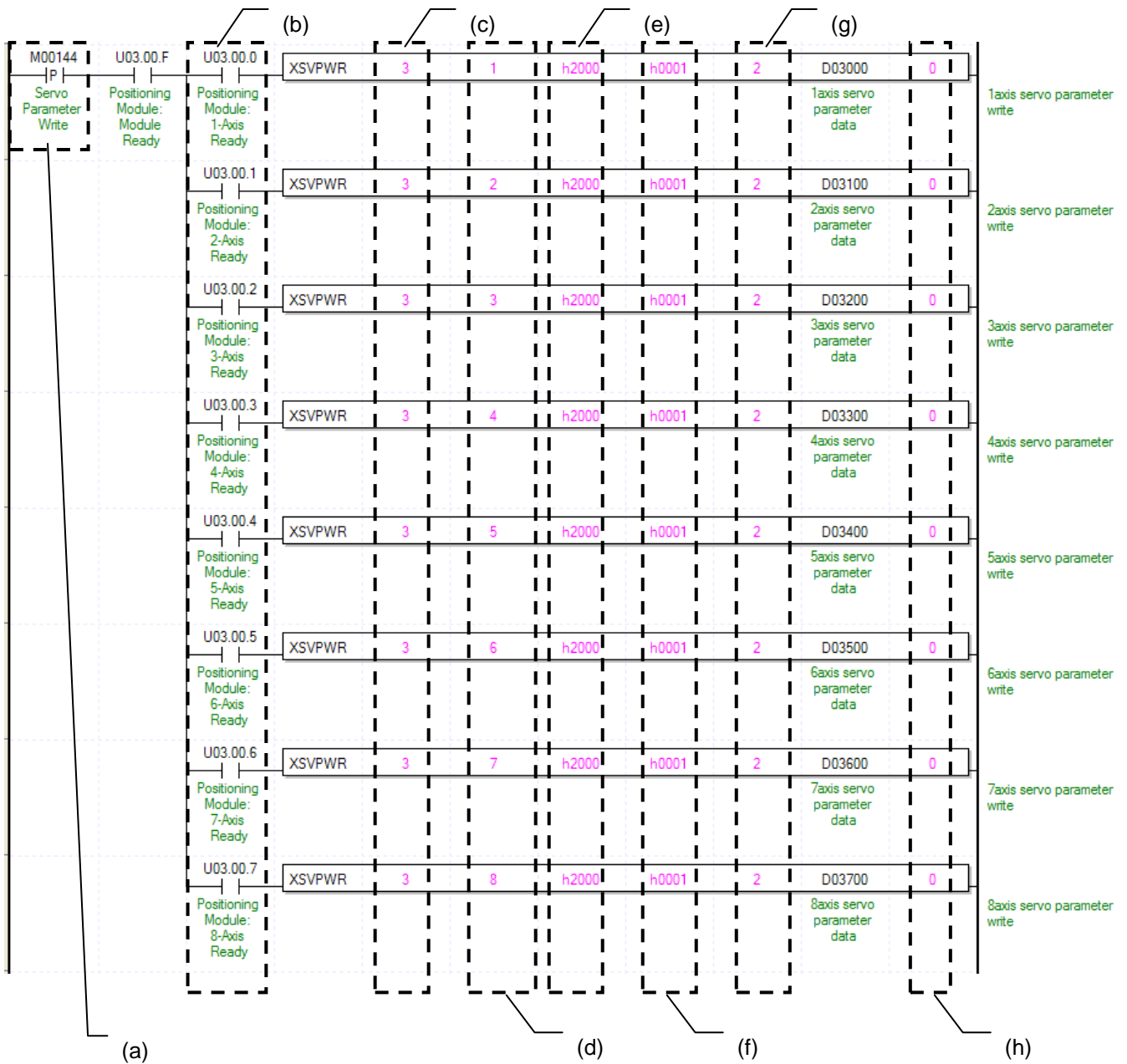

- (a) Condition of Servo Parameter Write
Condition of Servo Parameter Write Command (XSPWR). Once “Servo Parameter Write” is executed, it changes parameter object value of the servo driver into setting value.
- (b) Axis ready status
If communication between positioning module and servo drive is done, the signal corresponding to each signal will be on.
- (c) Address of Positioning Module
In this example, Positioning Module installed at the slot no.3 of 0 bases.
- (d) Axis of command execution
You can set an axis for Servo Parameter Write. XBF-PN04(8)B can supports for 4(8) axes. In the “execution of axis” from the configuration of Servo Parameter Write, you can set a value for axis 1 through axis 4(8).

(e) Servo driver parameter index

Index number of the parameter object among servo driver parameters. You can set up as follows.

Setting value	Description
0x2000 ~ 0x5FFF	Manufacturer Specific Profile Area
0x6000 ~ 0x9FFF	Standardized Device Profile Area

(f) Servo driver parameter sub-index

Index number of the parameter object among servo driver parameters. You can set up as follows.

Setting value	Description
0x0~0xFF	Servo parameter Object Subindex

(g) Servo driver parameter size

It set up size of the servo driver parameter. You can set up 1~4byte with 1~4.

(h) How to write the servo driver parameter

It determines whether to save the servo driver parameter at the internal RAM of the servo driver or at the internal EEPROM. If it is set as 0, it saves at RAM and if it is set as 1, it saves at EEPROM. When saving at EEPROM, it may take several scans according to servo driver model. You can check whether writing is complete or not, by seeing bit 7 among module axis information (refer to manual 5.4.1 state information list)

(3) Servo Driver Parameter Save (XSVMOVE)

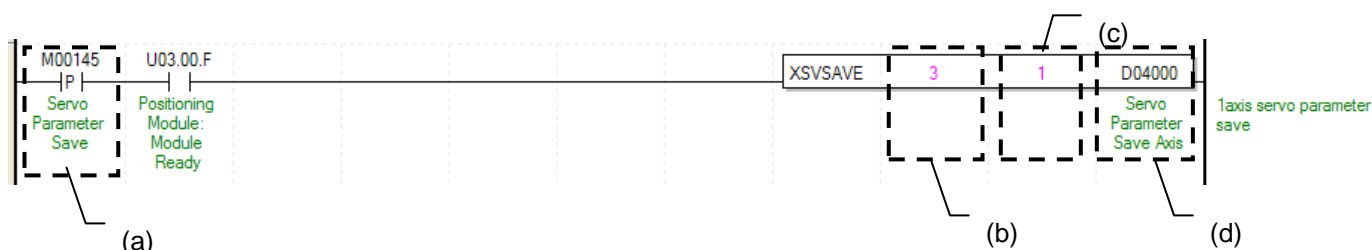

(a) Condition of Servo Parameter Save

Condition of Servo Parameter Save Command (XSVMOVE). Once "Servo Parameter Save" is executed, it saves parameter of the servo driver at the internal EEPROM.

(b) Address of Positioning Module

In this example, Positioning Module installed at the slot no.3 of 0 bases.

(c) Axis of command execution

You can set an axis for Servo Parameter Save. XBF-PN04(8)B can supports for 4(8) axes. In the "execution of axis" from the configuration of Servo Parameter Save, you can set a value for axis 1 through axis 4(8).

(d) Servo Driver Parameter Save Axis

It sets up the servo driver among servo drivers to save the parameter at the EEPROM. Select the servo driver by setting each bit as follows.

15 ~ 8 Bit	7Bit	6Bit	5Bit	4Bit	3Bit	2Bit	1Bit	0Bit
Not used	8axis	7axis	6axis	5axis	4axis	3axis	2axis	1axis

8.2 Example of XEC(IEC) Programming

8.2.1 General description

Here we supposed the positioning Module is installed at the 3 slot of the 0 base and two servo drivers are installed at axis1 and axis2. In the real usage, you need to change its value according to your actual set up.

8.2.2 Current State Read

(1) Bit Information about Operation state Reading (XPM_SRD)

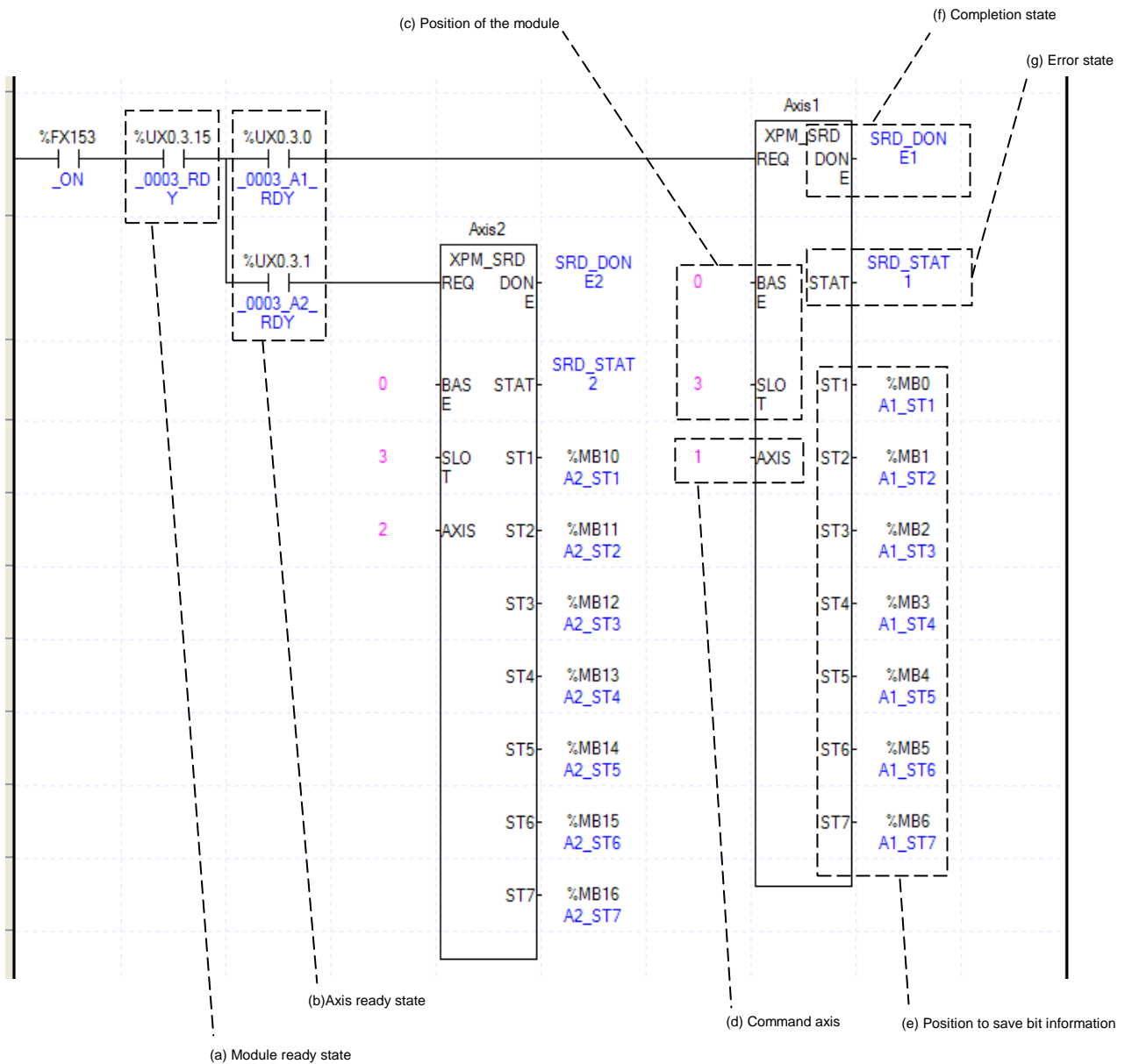

- (a) Module's ready
After Turn On, if there is no error occurred in Positioning Module, it is "ON," meaning that modules are ready to operate.
- (b) Axis ready
If communication between the positioning module and the servo driver is normal, corresponding signal will be on. In the example program, since _ON (Always ON), positioning module ready (UX0.3.15) and axis ready (UX0.3.0 ~ UX.3.1) are used, if there is no error in the module, it reads the current status every scan.
- (c) Address of Positioning Module
Before operation, you need to configure its position by numbers. In this example, Positioning Module is installed at the 3 slot.
- (d) Axis of operation
If you command each axis, need to set Axis of command execution. XBF-PN04(8)B can control max 4(8) axes and Axis of command execution 1~4(8) means axis1~axis4(8).
- (e) The position for saving bit information
Set the device to save bit state value of axis from the module with XPM_SRD. This device is available to be used in sequence program as a condition. For example, the current bit state in the example program above is saved in %MB0 ~ % MB6. For the detail description about the device saved, refer to "7.3.2 Current Operation State Bit Information Reading". Bit information which saved in a device is available to be used to execute another command. For example, if you need to use In-operation-signal of axis1, just set as %MB0.0. If you need to use Error-state of axis2, just set %MB10.1.
- (f) State of Operation complete
If function block is completed without error, "1" will be outputted and maintain "1" until the next operation. If error occurred, "0" will be outputted.
- (g) Error State
This is the area that output error no. if there are errors in operation of function block.

(2) Current Operation Information Reading

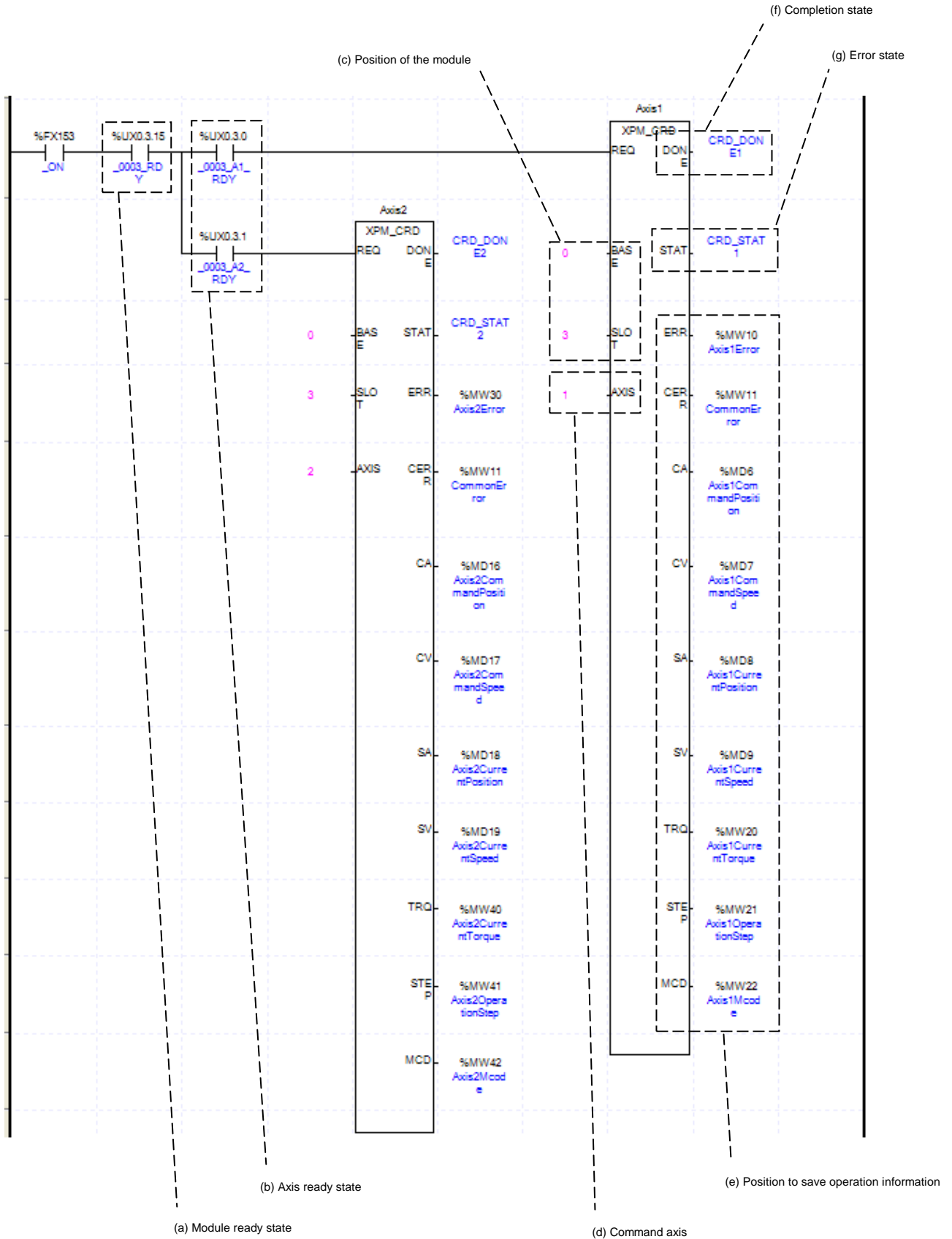

- (a) Module's ready
After Turn On, if there is no error occurred in Positioning Module, it is "ON," meaning that modules are ready to operate.
- (b) Axis ready
If communication between the positioning module and the servo driver is normal, corresponding signal will be on. In the example program, since _ON (Always ON), positioning module ready (UX0.3.15) and axis ready (UX0.3.0 ~ UX.3.1) are used, if there is no error in the module, it reads the current status every scan.
- (c) Address of Positioning Module
Before operation, you need to configure its position by numbers. In this example, Positioning Module is installed at the 3 slot.
- (d) Axis of operation
If you command each axis, need to set Axis of command execution. XBF-PN04(8)B can control max. 4(8) axes, Axis of command execution1~4(8) means axis1~axis4(8).
- (e) The position for saving operation information
Set the device to save operation state value of axis from the module with XPM_CRD. This device is available to be used in sequence program as a monitoring value. For example, the current position value of axis1 in the example program above is saved in %MD8. For the detail description about the device saved, refer to "7.3.1 Operation Information Reading (XPM_CRD)".
- (f) State of Operation complete
If function block is completed without error, "1" will be outputted and maintain "1" until the next operation. If error occurred, "0" will be outputted.
- (g) Error State
This is the area that output error no. if there are errors in operation of function block.

(3) Encoder value Reading

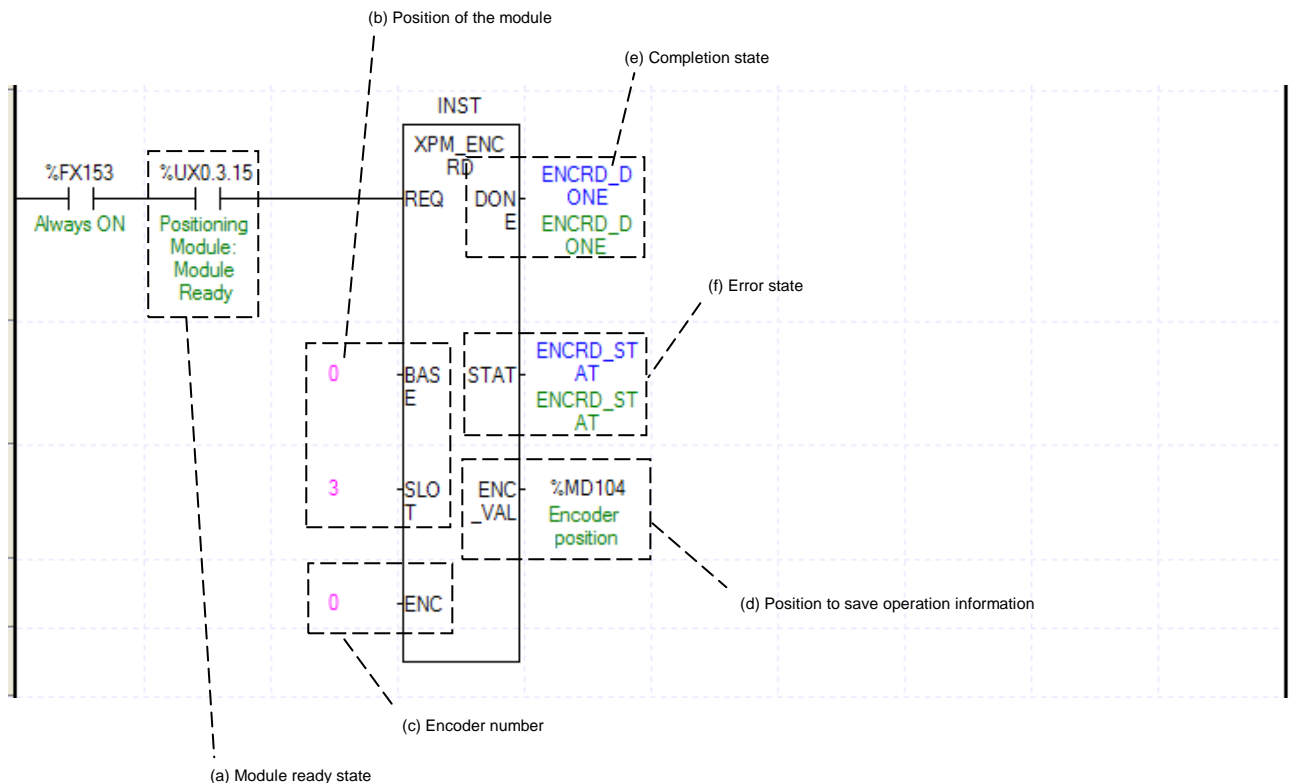

- (a) Module's ready
After Turn On, if there is no error occurred in Positioning Module, it is "ON," meaning that modules are ready to operate.

- (b) Address of Positioning Module
Before operation, you need to configure its position by numbers. In this example, Positioning Module is installed at the 3 slot.
- (c) Encoder No.
Set the encoder no. to read encoder value.
0: encoder1
- (d) Encoder value
The current value of encoder is displayed.
- (e) State of Operation complete
If function block is completed without error, "1" will be outputted and maintain "1" until the next operation. If error occurred, "0" will be outputted.
- (f) Error State
This is the area that output error no. if there are errors in operation of function block.

(4) Reading Servo Error Information (XPM_SVERD)

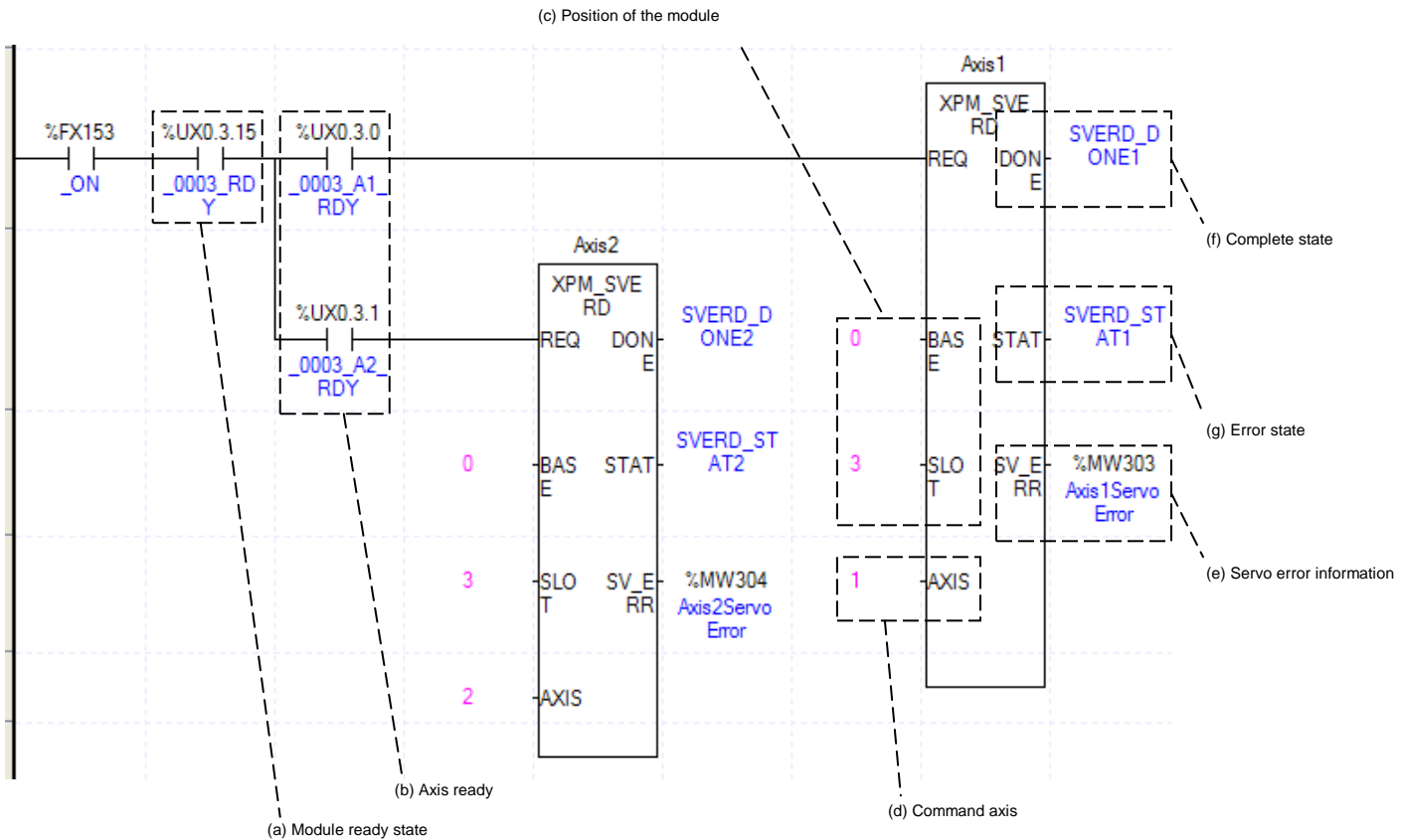

- (a) Module's ready
After Turn On, if there is no error occurred in Positioning Module, it is "ON," meaning that modules are ready to operate.
- (b) Axis ready
If communication between the positioning module and the servo driver is normal, corresponding signal will be on. In the example program, since _ON (Always ON), positioning module ready (UX0.3.15) and axis ready (UX0.3.0 ~ UX0.3.1) are used, if there is no error in the module, it reads the current status every scan.
- (c) Address of Positioning Module
Before operation, you need to configure its position by numbers. In this example, Positioning Module is installed at the 3 slot.
- (d) Axis of operation
If you command each axis, need to set Axis of command execution. XBF-PN04(8)B can control max. 4(8) axes and Axis of command execution 1~4(8) means axis1~axis4(8).

(e) Servo error information

It specifies the device to save "servo error information" read by "XPM_SVERD". You can use this device as execution condition in the sequence program. In the above example, current servo error information of axis 1 is saved in the device "%MW303".

(f) State of Operation complete

If function block is completed without error, "1" will be outputted and maintain "1" until the next operation. If error occurred, "0" will be outputted.

(g) Error State

This is the area that output error no. if there are errors in operation of function block.

(5) Reading Servo Input Information (XPM_SVIRD)

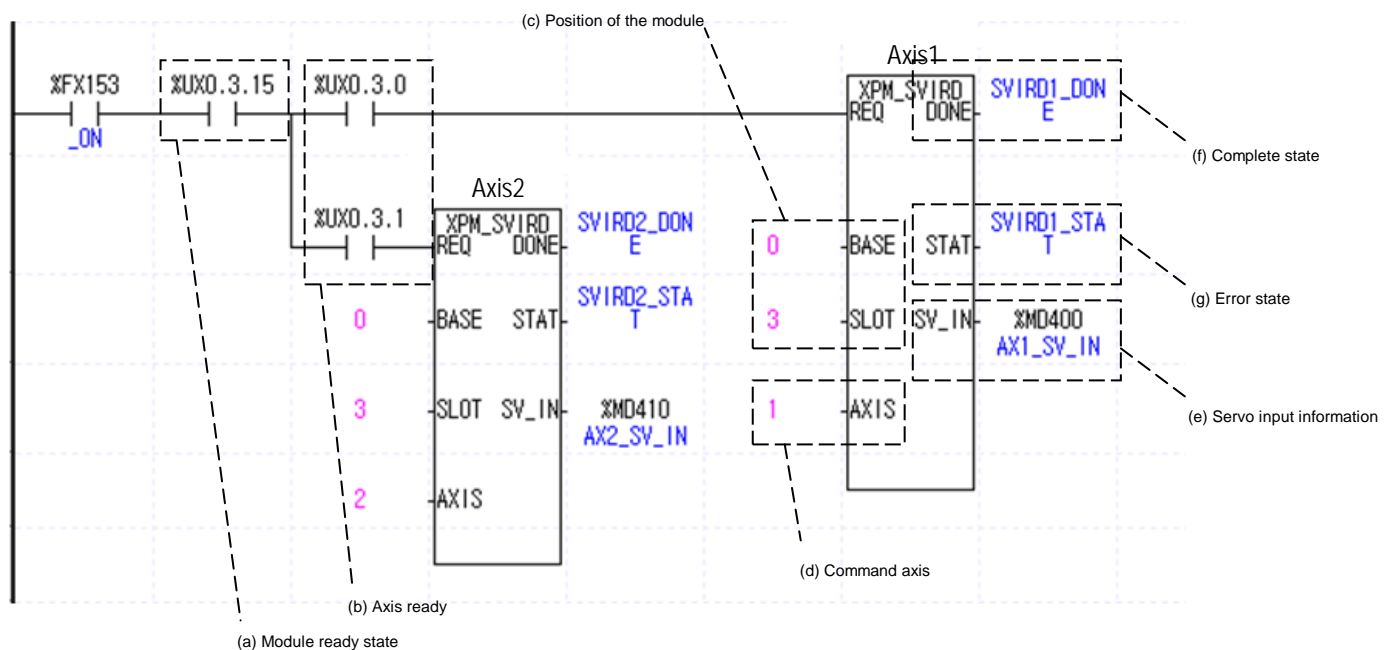

(a) Module's ready

After Turn On, if there is no error occurred in Positioning Module, it is "ON," meaning that modules are ready to operate.

(b) Axis ready

If communication between the positioning module and the servo driver is normal, corresponding signal will be on. In the example program, since `_ON` (Always ON), positioning module ready (`UX0.3.15`) and axis ready (`UX0.3.0 ~ UX.3.1`) are used, if there is no error in the module, it reads the current status every scan.

(c) Address of Positioning Module

Before operation, you need to configure its position by numbers. In this example, Positioning Module is installed at the 3 slot.

(d) Axis of operation

If you command each axis, need to set Axis of command execution. XBF-PN04(8)B can control max. 4(8) axes and Axis of command execution 1~4(8) means axis1~axis4(8).

(e) Servo input information

It sets the device to save input signal information of the each axis from positioning module by using `XPM_SVIRD`. This device can be used as a condition in sequence program. For example above, servo input signal information of 1-axis is saved at `%MD400`.

(f) State of Operation complete

If function block is completed without error, "1" will be outputted and maintain "1" until the next operation. If error occurred, "0" will be outputted.

(g) Error State

This is the area that output error no. if there are errors in operation of function block.

(6) Read Latch Position Data (XPM_LRD)

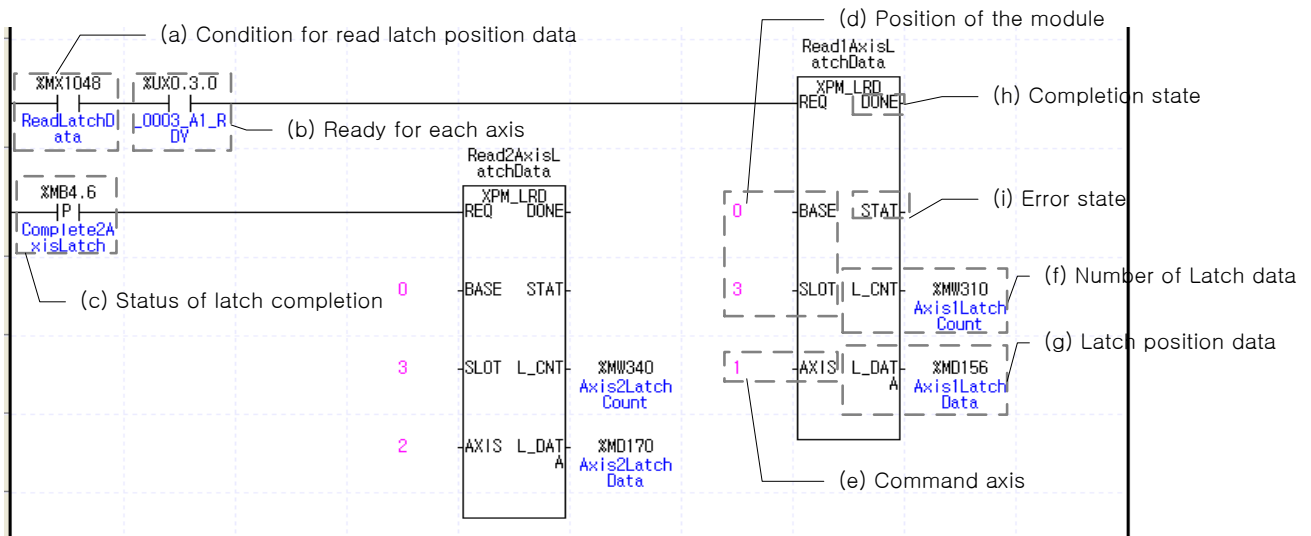

(a) Conditions to Read Latch Position Data

Conditions to implement the Read Latch Position Data command (XPM_LRD). Fox Axis 1, the Read Latch Position Data command is always implement if %MX1048 is On after the axis is connected with the network.

(b) Axis ready state

If communication between the positioning module and the servo driver is normal, corresponding signal will be on. In the example program, latch position data are read if %MX1048 (Read latch position data) is On after the axis is connected with the module since Axis 1 preparation state (UX0.3.0) is used.

(c) Status of Latch Completion

It is the state of "Latch Completion" when an example program of "8.2.2 Read the Current Sate." It is on when latch is completed once external latch command signal of the relevant axis is inputted. In case of Axis 2, the Read Latch Position Data command of Axis 2 is implemented as soon as %MB4.6 (Latch Completion state) is On.

(d) Address of Positioning Module

Before operation, you need to configure its position by numbers. In this example, Positioning Module is installed at the 3 slot..

(e) Axis of operation

If you command each axis, need to set Axis of command execution. XBF-PN04(8)B can control maximum 4(8) axes. Axis of command execution1~4(8) means axis1~axis4(8).

(f) Number of latch position data

It is the device to save the axis's number of latch data value read from the positioning module by using XPM_LRD. This device can be used on sequence programs. For example, Axis1's data number of latch position is saved on %MW310.

(g) Latch position data

It is the device to save the axis's latch data value read from the positioning module by using XPM_LRD. This device can be used on sequence programs. For example, Axis 1's data of latch position is saved on %MD156 through %MD165.

(h) Status of Operation complete

If function block is completed without error, "1" will be outputted and maintain "1" until the next operation. If error occurred, "0" will be outputted.

(i) Error state

This is the area that output error no. if there are errors in operation of function block.

8.2.3 Operation Ready

(1) Connecting servo driver

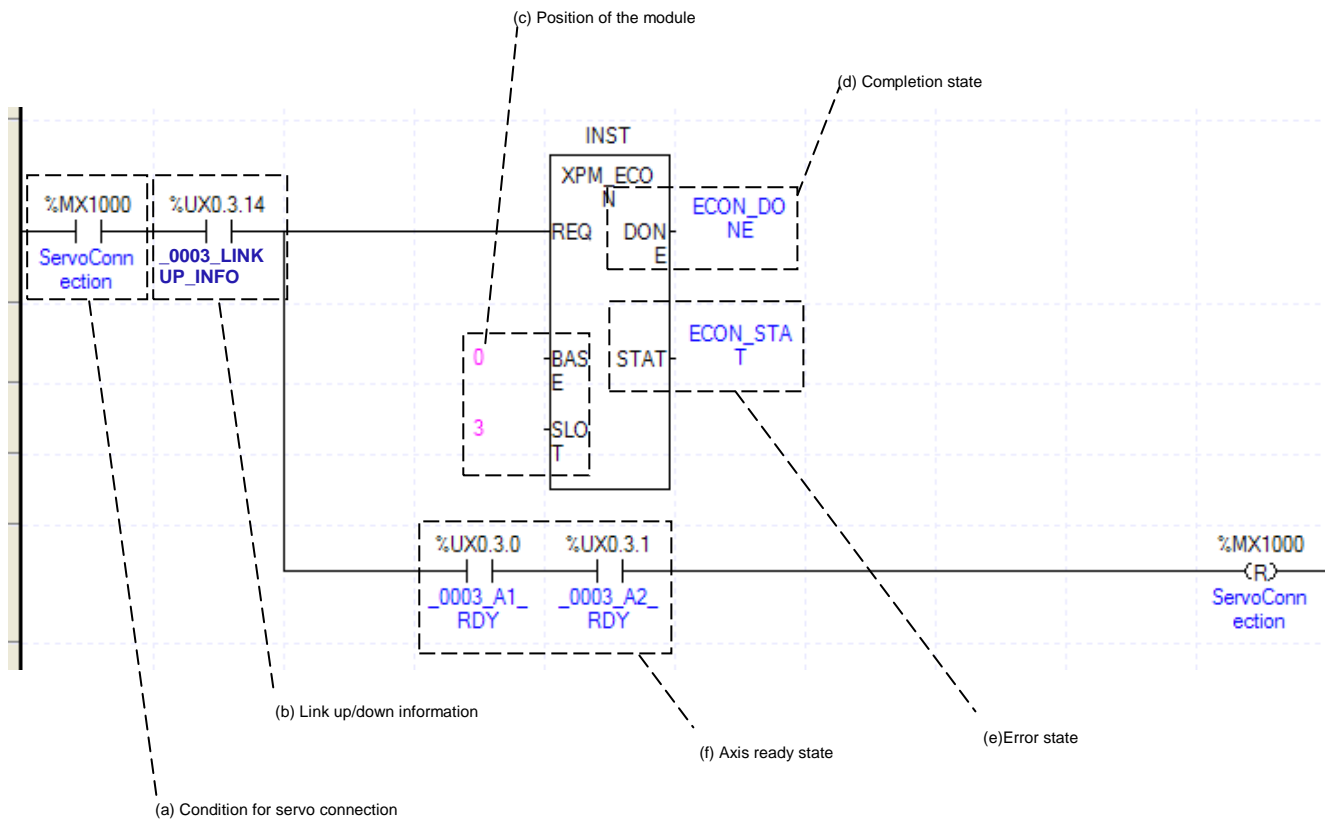

(a) Condition for servo connection

Condition to execute Servo connection command (XPM_ECON)

(b) Link up/down information

If you use Link up down information as input condition point of servo connection command, you can execute the command only when network cable is actually connected.

(c) Address of Positioning Module

Before operation, you need to configure its position by numbers. In this example, Positioning Module is installed at the 3 slot.

(d) State of Operation complete

If function block is completed without error, "1" will be outputted and maintain "1" until the next operation. If error occurred, "0" will be outputted.

(e) Error State

This is the area that output error no. if there are errors in operation of function block.

(f) Axis ready state

If connection with servo driver is established, corresponding signal will be on. In the example, we assume that two axes are connected to the module. Set the only connected axis according to system. If connection is complete, corresponding signal will be on and reset the condition for servo connection.

(2) Disconnecting servo driver

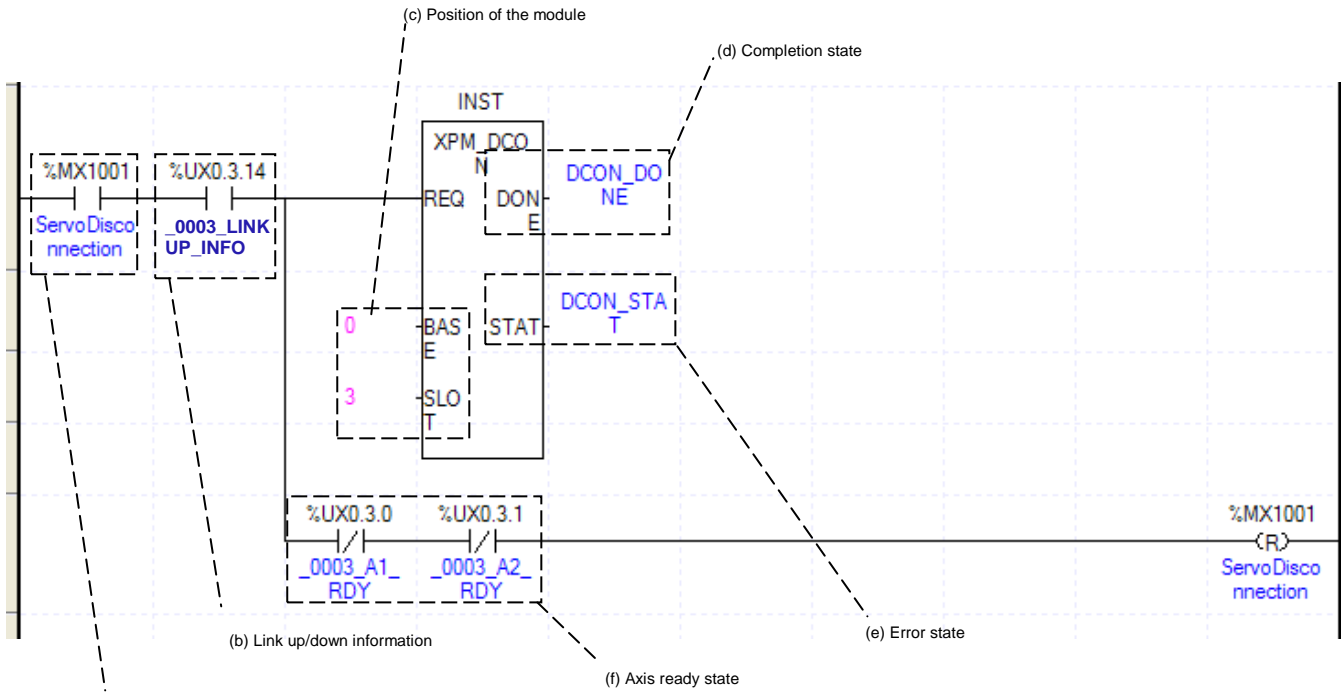

- (a) Condition for servo disconnection
Condition to execute Servo disconnection command (XPM_DCON)
- (b) Link up/down information
If you use Link up down information as input condition point of servo connection command, you can execute the command only when network cable is actually connected.
- (c) Address of Positioning Module
Before operation, you need to configure its position by numbers. In this example, Positioning Module is installed at the 3 slot.
- (d) State of Operation complete
If function block is completed without error, "1" will be outputted and maintain "1" until the next operation. If error occurred, "0" will be outputted.
- (e) Error State
This is the area that output error no. if there are errors in operation of function block.
- (f) Axis ready state
If disconnection with servo driver is complete, corresponding signal will be off. In the example, we assume that two axes are connected to the module. Set the only connected axis according to system. If disconnection is complete, corresponding signal will be off and reset the condition for servo disconnection.

(3) Servo On

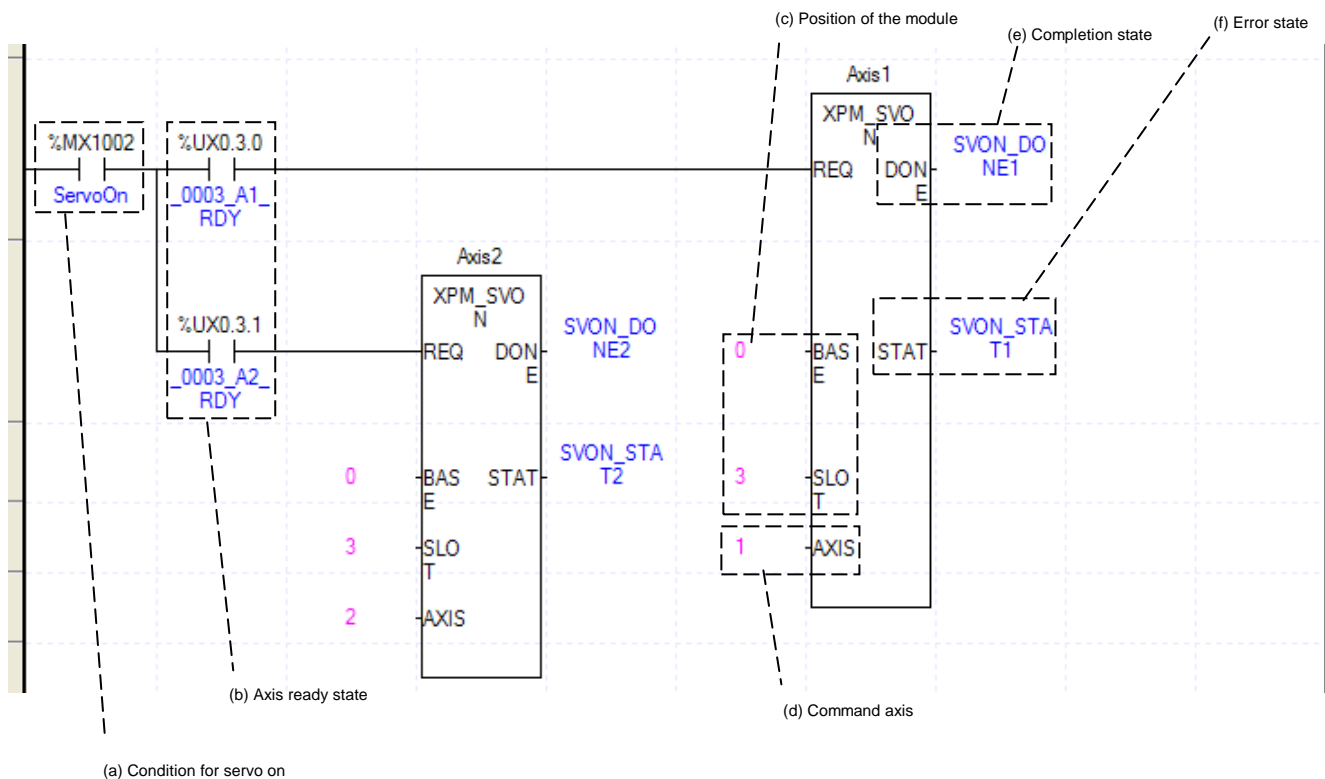

(a) Condition for servo on

Condition to execute Servo on command (XPM_SVON)

(b) Axis ready

If communication between the positioning module and the servo driver is normal, corresponding signal will be on. In the example program, if the condition for “Servo on” is on, it will gives “Servo on” command. You can remove the axis not connected.

(c) Address of Positioning Module

Before operation, you need to configure its position by numbers. In this example, Positioning Module is installed at the 3 slot.

(d) Axis of operation

If you command each axis, need to set Axis of command execution. XBF-PN04(8)B can control max. 4(8) axes. Axis of command execution1~4(8) means axis1~axis4(8).

(e) State of Operation complete

If function block is completed without error, “1” will be outputted and maintain “1” until the next operation. If error occurred, “0” will be outputted.

(f) Error State

This is the area that output error no. if there are errors in operation of function block.

(g) If “Servo on” command is executed, corresponding servo driver will be “Servo on” state.

(4) Servo Off

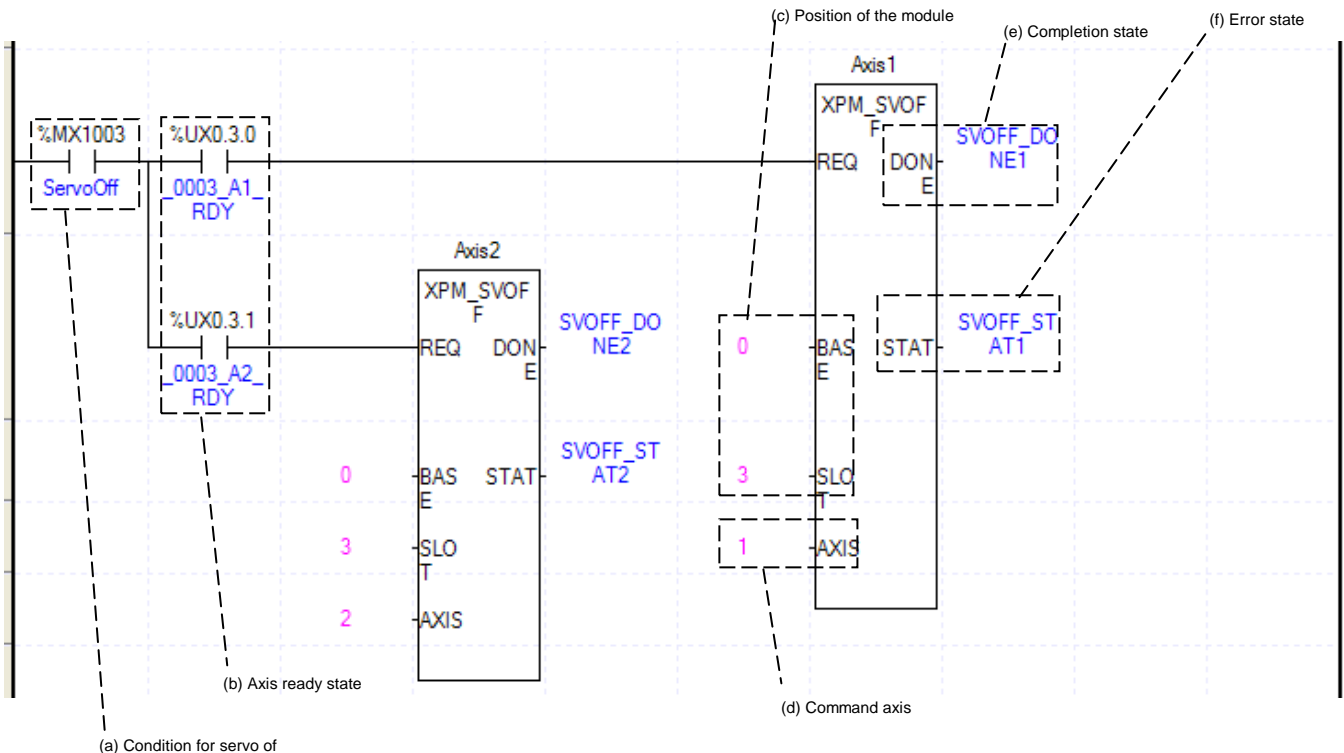

(a) Condition for servo off

Condition to execute Servo off command (XPM_SVOFF)

(b) Axis ready

If communication between the positioning module and the servo driver is normal, corresponding signal will be on. In the example program, if the condition for “Servo off” is on, it will gives “Servo off” command. You can remove the axis not connected

(c) Address of Positioning Module

Before operation, you need to configure its position by numbers. In this example, Positioning Module is installed at the 3 slot.

(d) Axis of operation

If you command each axis, need to set Axis of command execution. XBF-PN04(8)B can control max. 4(8) axes. Axis of command execution1~4(8) means axis1~axis4(8).

(e) State of Operation complete

If function block is completed without error, “1” will be outputted and maintain “1” until the next operation. If error occurred, “0” will be outputted.

(f) Error State

This is the area that output error no. if there are errors in operation of function block.

(g) If “Servo off” command is executed, corresponding servo driver will be “Servo off” state.

8.2.4 Operation Test

(1) Floating Origin Setting

Decide origin of current motor's position without set a machinery origin.

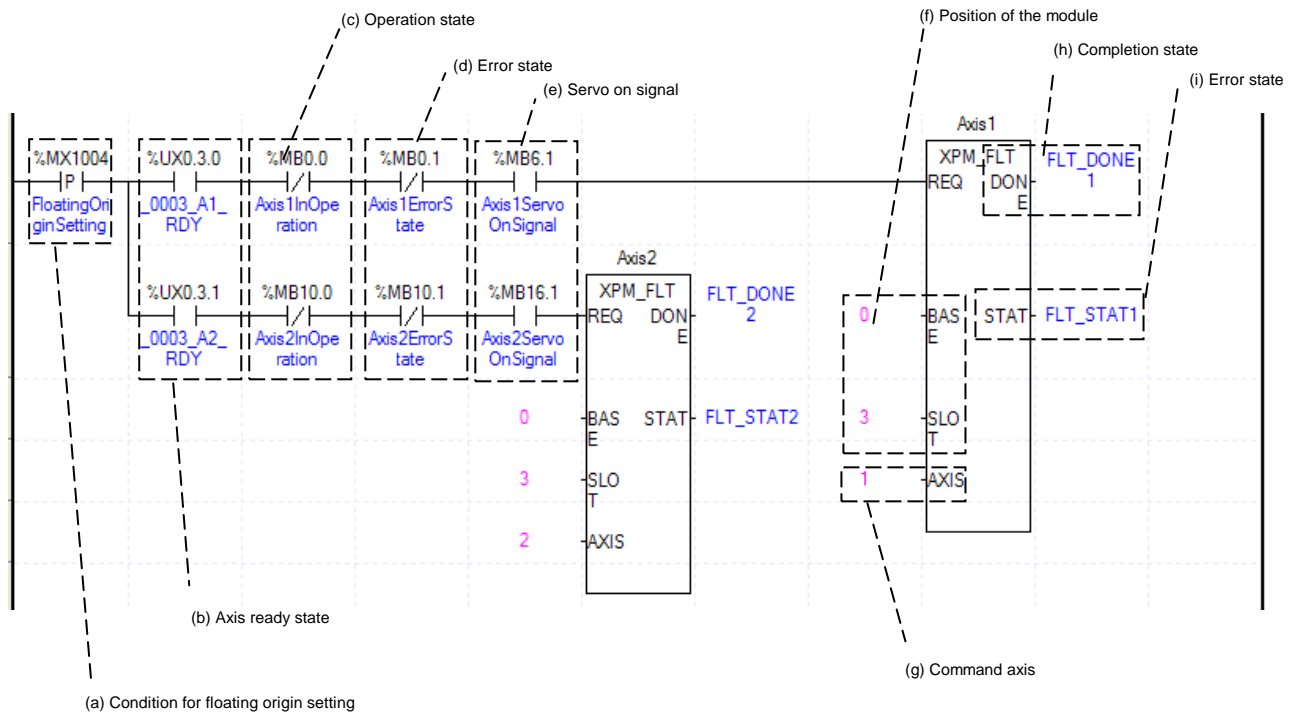

(a) This is the condition for running a Floating Origin Setting
It only works with XPM_FLT command.

(b) Axis ready

If communication between the positioning module and the servo driver is normal, corresponding signal will be on.

(c) Operating state by axis

According to exercise from “Chapter 8.2.2 Current State Reading,” it is a signal of “Operating” for each axis. When corresponding axis is not operating, it is on. Since “Floating origin setting” command can’t be executed, the condition is set to execute when axis is not operating. If you execute “Floating origin setting” command while axis is operating, error 211 will appear.

(d) Error state for each axis

According to exercise from “Chapter 8.2.2 Current State Reading,” it is a signal of “Error state” for each axis. It turns on when an error occurred. Operation will only work when there is no error. If you want to operate a system regardless of errors, you can just inactivate the function.

(e) Servo On signal

When applying the example program of “8.2.2 Current State Read”, this is “Servo On” signal for each axis. When each axis is Servo On state, it will be on. Since floating origin setting command can’t be executed when the axis is not servo on, it makes command executed when servo driver is “Servo On” state. If you execute floating origin setting command when axis is not Servo On state, the error 212 occurs.

(f) Address of Positioning Module

In this example, Positioning Module is installed at the 3 slot of 0 bases.

(g) Axis of command execution

You can set an axis for Floating Origin Setting. XBF-PN04(8)B supports for 4(8) axes. In the “execution of axis” from the configuration of Floating Origin Setting, you can set a value for axis1 through axis 4(8)

(h) State of Operation complete

If function block is completed without error, “1” will be outputted and maintain “1” until the next operation. If error occurred, “0” will be outputted.

(i) Error State

This is the area that output error no. if there are errors in operation of function block.

(2) Jog Operation

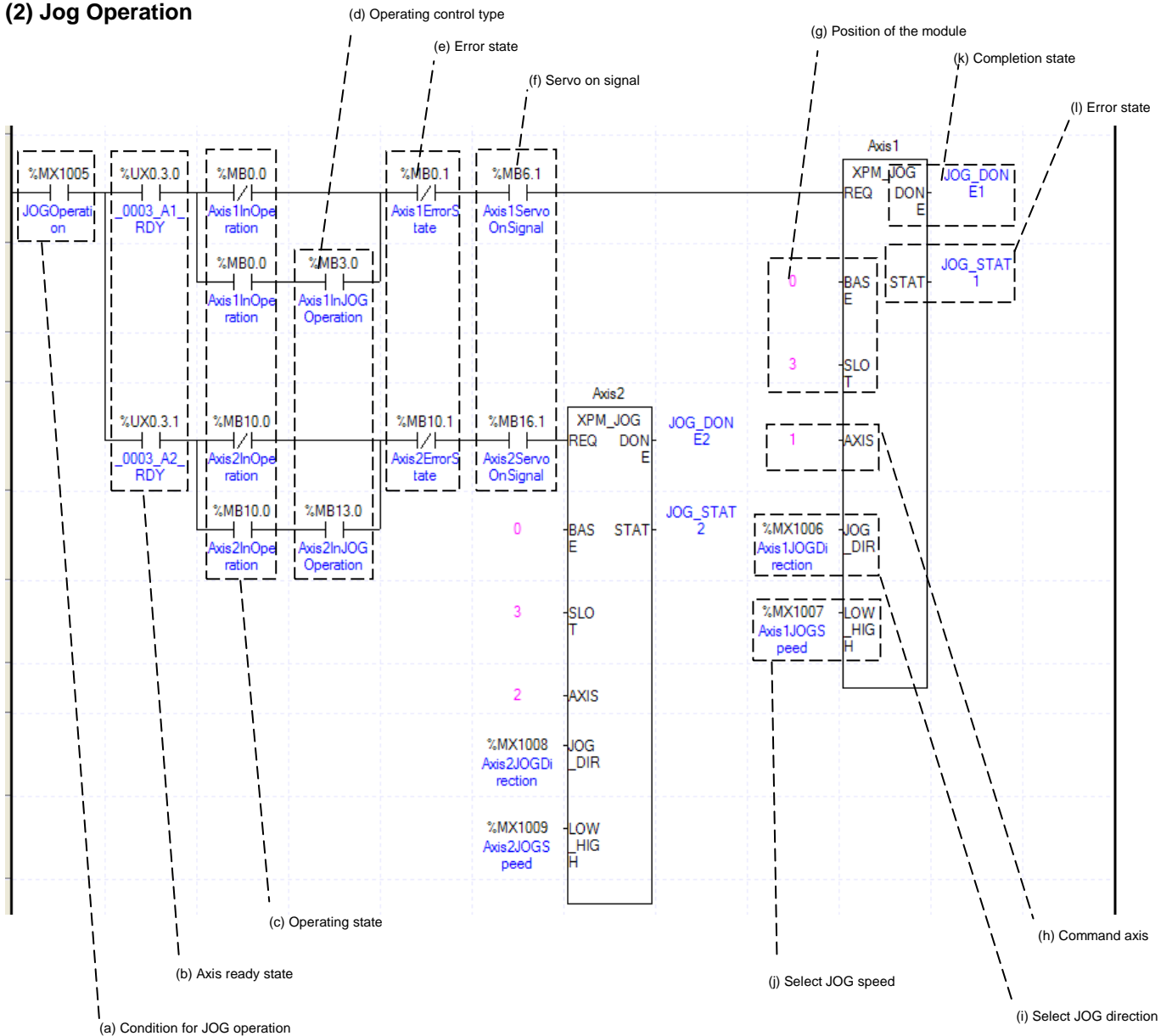

(a) This is the condition for Jog Operation

This is the condition for Jog Operation Command

(b) Axis ready

If communication between the positioning module and the servo driver is normal, corresponding signal will be on.

(c) Operating state by axis

Jog Operation can only be working when the state of axis set as Jog Operation. In this example above, specific axis set as Jog Operation otherwise it is not operating.

(d) State of driving control by axis

According to exercise from “Chapter 8.2.2 Current State Reading,” it is a signal of “Jog Operating” for each axis. It turns on when it is operating. Jog Operation configuration can be changed while it is operating.

(e) Error state for each axis

According to exercise from “Chapter 8.2.2 Current State Reading,” it is a signal of “Error state” for each axis. It turns on when an error occurred. Operation will only work when there is no error. If you want to operate a system regardless of errors, you can just inactivate the function.

(f) Servo On signal

When applying the example program of “8.2.2 Current State Read”, this is “Servo On” signal for each axis.

When each axis is Servo On state, it will be on. Since JOG operation can't be executed when the axis is not "servo on", it makes command executed when servo driver is "Servo On" state. If you execute JOG operation when axis is not Servo On state, the error 413 occurs.

(g) Address of Positioning Module

The module is attached to slot no.3 of no.0 base.

(h) Axis of command execution

Set an axis to execute Jog Operation. XBF-PN04(8)B can control max. 4(8) axes. It is available to set 1 ~ 4(8)(axis1~axis4(8)) on "Axis of command execution" of Jog operation command.

(i) Selection for Jog Direction

Set the direction of Jog operation. If Input value is 0, it will execute Jog operation in forward direction. If Input value is 1, it will execute Jog operation in reverse direction. Direction is can be changed in operation.

(j) Selection for Jog Speed

Set the speed of Jog operation. If Input value is 0, it will execute low speed Jog operation. If Input value is 1, it will execute high speed Jog operation. Operating speed can be changed in operation.

(k) State of Operation complete

If function block is completed without error, "1" will be outputted and maintain "1" until the next operation. If error occurred, "0" will be outputted.

(l) Error State

This is the area that output error no. if there are errors in operation of function block.

(3) Inching Operation

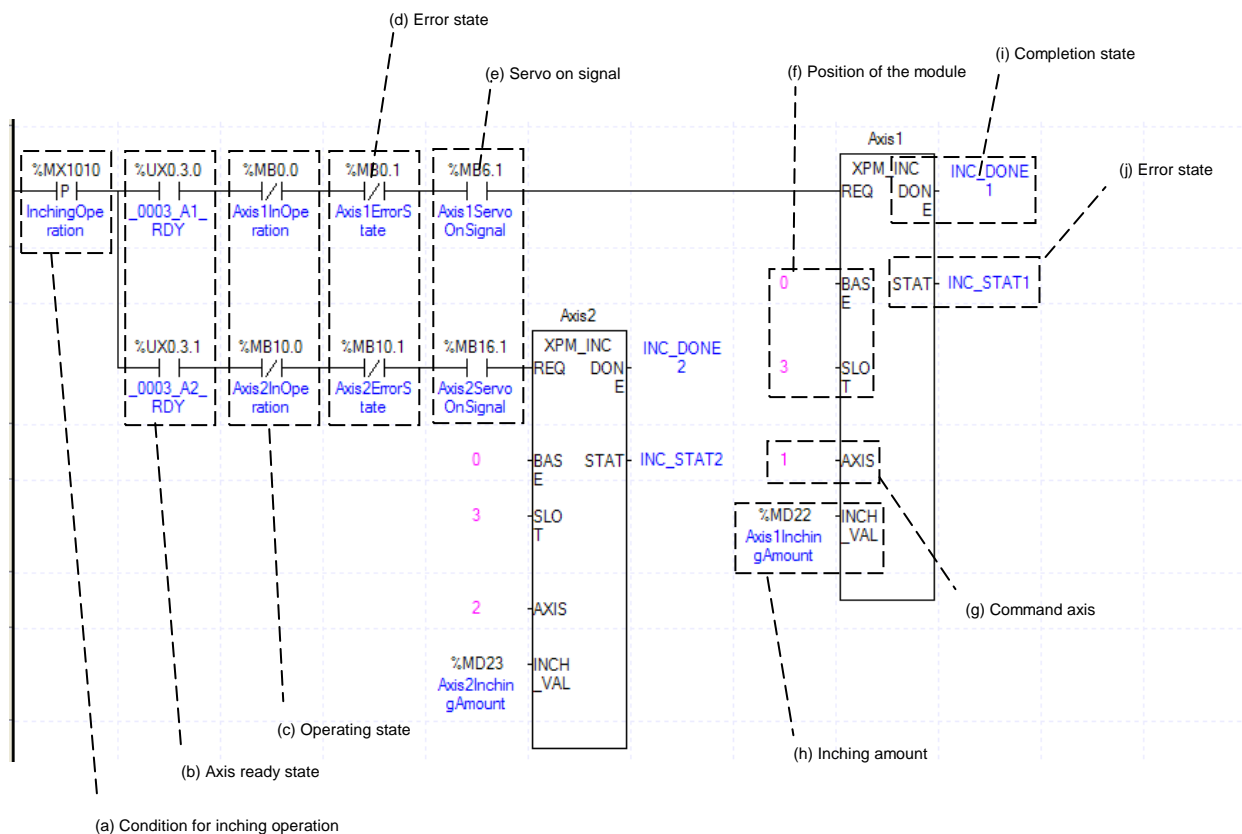

(a) This is the condition for Inching Operation

This is the condition for Inching Operation Command (XPM_INC)

(b) Axis ready

If communication between the positioning module and the servo driver is normal, corresponding signal will be on.

(c) Operating state by axis

According to exercise from "Chapter 8.2.2 Current State Reading," it is a signal of "Operating" for each axis.

When corresponding axis is not operating, it is on. Since “Inching operation” command can’t be executed, the condition is set to execute when axis is not operating. If you execute “Inching operation” command while axis is operating, error 401 will appear.

- (d) Error state for each axis
According to exercise from “Chapter 8.2.2 Current State Reading,” it is a signal of “Error state” for each axis. It turns on when an error occurred. Operation will only work when there is no error. If you want to operate a system regardless of errors, you can just inactivate the function.
- (e) Servo On signal
When applying the example program of “8.2.2 Current State Read”, this is “Servo On” signal for each axis. When each axis is Servo On state, it will be on. Since “Inching operation” command can’t be executed when the axis is not servo on, it makes command executed when servo driver is “Servo On” state. If you execute “Inching operation” command when axis is not Servo On state, the error 403 occurs.
- (f) Address of Positioning Module
In this example, Positioning Module is installed at the 3 slot of 0 bases.
- (g) Axis of command execution
You can set an axis for Inching Operation. XBF-PN04(8)B supports for 4(8) axes. In the “execution of axis” from the configuration of Inching Operation, you can set a value for axis1 through axis4(8).
- (h) Amount of Inching Operation Movement
Measure the amount of moving range by Inching Operation.
- (i) Complete Operating Status
If function block is completed without error, “1” will be outputted and maintain “1” until the next operation. If error occurred, “0” will be outputted.
- (j) Error Status
This is the area that output error no. if there are errors in operation of function block.
- (k) Reference for Inching Operation is from “Chapter 7.6.2.”

(4) Return to the position before Manual Operation

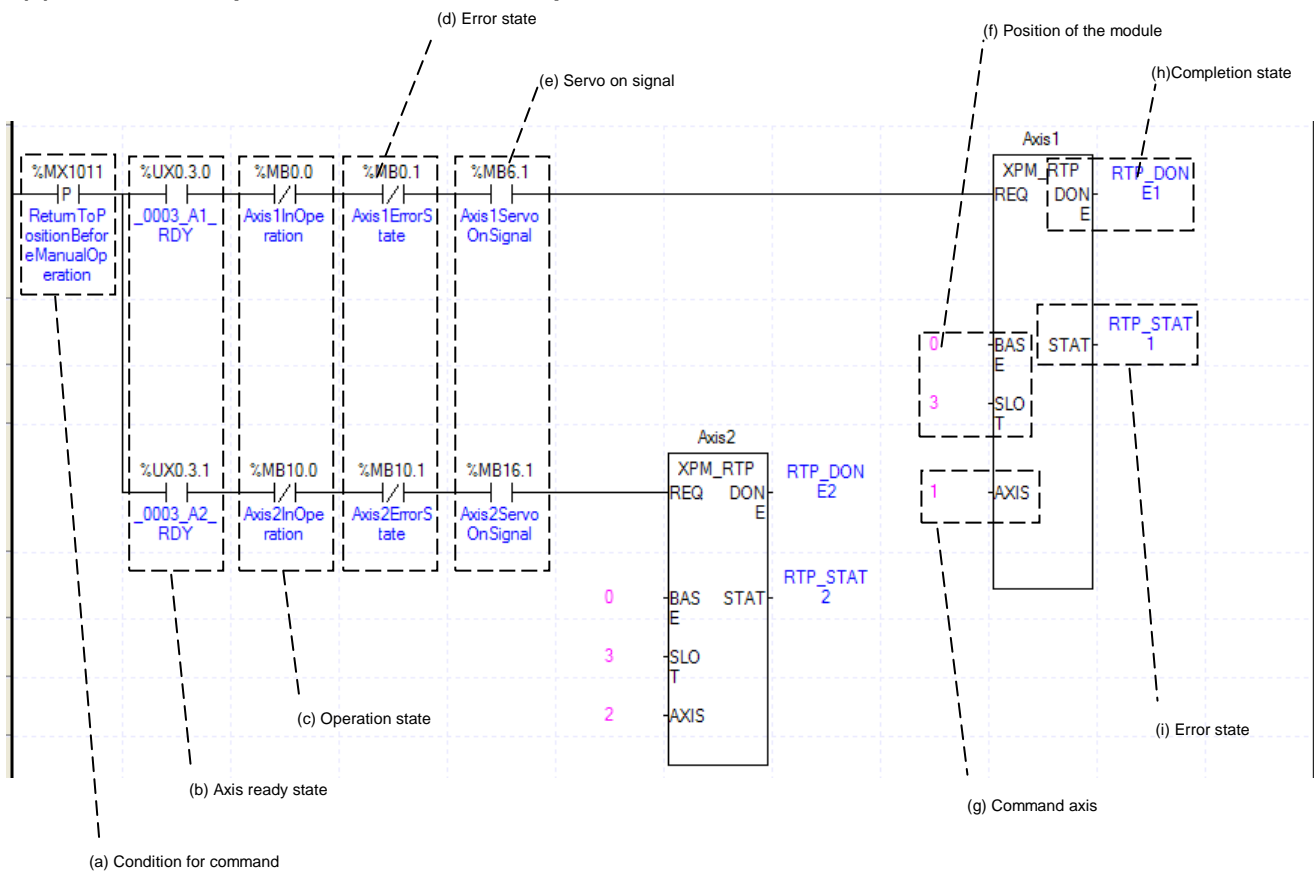

- (a) This is the condition for Return to the position before Manual Operation
This is the condition for Return to the position before Manual Operation Command (XPM_RTP)
- (b) Axis ready
If communication between the positioning module and the servo driver is normal, corresponding signal will be on.
- (c) Operating state by axis
According to exercise from “Chapter 8.2.2 Current State Reading,” it is a signal of “Manual Operating” for each axis. It turns on when it is operating. Inching Operation can not be configured while it is running hence configuration will only be configured when it is not running. If you execute Manual Operation while it is running, the “error 431” would be appeared.
- (d) Error state for each axis
According to exercise from “Chapter 8.2.2 Current State Reading,” it is a signal of “Error state” for each axis. It turns on when an error occurred. Operation will only work when there is no error. If you want to operate a system regardless of errors, you can just inactivate the function.
- (e) Servo On signal
When applying the example program of “8.2.2 Current State Read”, this is “Servo On” signal for each axis. When each axis is Servo On state, it will be on. Since RTP command can't be executed when the axis is not servo on, it makes command executed when servo driver is “Servo On” state. If you execute RTP command when axis is not Servo On state, the error 434 occurs.
- (f) Address of Positioning Module
In this example, Positioning Module is installed at the 3 slot of 0 bases.
- (g) Axis of command execution
You can set an axis for Inching Operation. XBF-PN04(8)B supports for 4(8) axes. In the “execution of axis” from the configuration of Manual Operation, you can set a value for axis1 through axis4(8).
- (i) State of Operation complete
If function block is completed without error, “1” will be outputted and maintain “1” until the next operation. If error occurred, “0” will be outputted.
- (j) Error State
This is the area that output error no. if there are errors in operation of function block.
- (h) When manual operation is running, the other operations are going back to its original position such as Jog Operation and Inching Operation. Reference for Manual Operation is from “Chapter 7.6.3 Return to the previous position of manual operation.”

8.2.5 Parameter and Operation Data Setting

(1) Parameter Setting

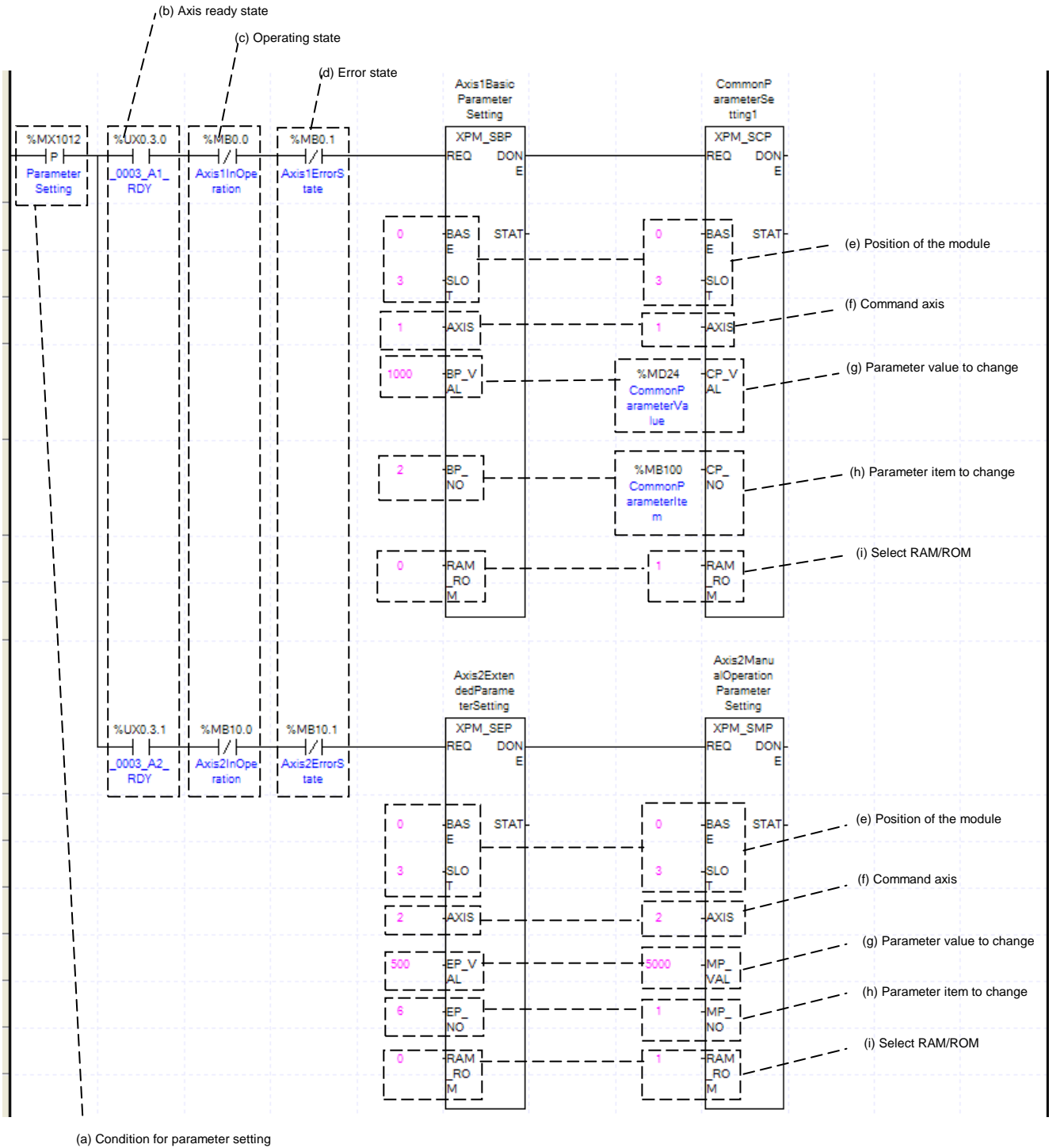

- (a) This is the condition for Parameter Setting Command
This is the condition for Parameter Setting Command (XPM_SBP, XPM_SEP, XPM_SMP, XPM_SCP)
- (b) Axis ready
If communication between the positioning module and the servo driver is normal, corresponding signal will be on.
- (c) Operating state by axis
According to exercise from "Chapter 8.2.2 Current State Reading," it is a signal of "Operating" for each axis. It turns on when it is operating. Except common parameter setting, parameter setting can not be configured while it is running hence configuration will only be configured when it is not running. If you execute Parameter Setting while it is running, the "error 471" would be appeared.
- (d) Error state for each axis
According to exercise from "Chapter 8.2.2 Current State Reading," it is a signal of "Error state" for each axis. It turns on when an error occurred. Operation will only work when there is no error. If you want to operate a system regardless of errors, you can just inactivate the function.
- (e) Address of Positioning Module
In this example, Positioning Module is installed at the 3 slot of 0 bases.
- (f) Axis of command execution
You can set an axis for Parameter Setting. XBF-PN04(8)B supports for 4(8) axes. In the "execution of axis" from the configuration of Parameter Setting, you can set a value for axis1 through axis4(8).
- (g) Value of Changing Parameter
You can set a value of changing parameter. For more information about Parameter Value Changing look for "Chapter 6. Command." In case of setting I/O parameter, the value would be parameter value itself.
- (h) List of Changing Parameter
You need to set a list for parameter (f) changing from set command. Once operating is working, this value will change to parameter (f). For more information of list of changing parameter look for "Chapter 6. Command." In case of setting I/O parameter, the value would be parameter value itself. Therefore changing of list would not be necessary.
- (i) ROM/RAM Setting
This function sets whether you save value of changing parameter to Rom or Ram. If you choose Rom the data will be saved regardless of power and if you save in the ram the data will be vanished when powers off. This parameter sets as 1 means Rom saved, and sets as 0 means Ram saved. There is no limitation of saving parameters in the Rom since parameter of Positioning Module saved in the MRAM.
- (j) Execution content of each function block is as follows.
XPM_SBP : RAM Setting Acc. Time of basic parameter of axis1 as 1000ms
XPM_SEP : RAM Setting 2 axes linear interpolation continuous operation position that circular arc is added as 500
XPM_SMP : ROM Setting Jog speed of axis2 manual operation parameter as 5000.
XPM_SCP : ROM Setting %MB100 of common parameter as %MD24.

(2) Operating Data Setting

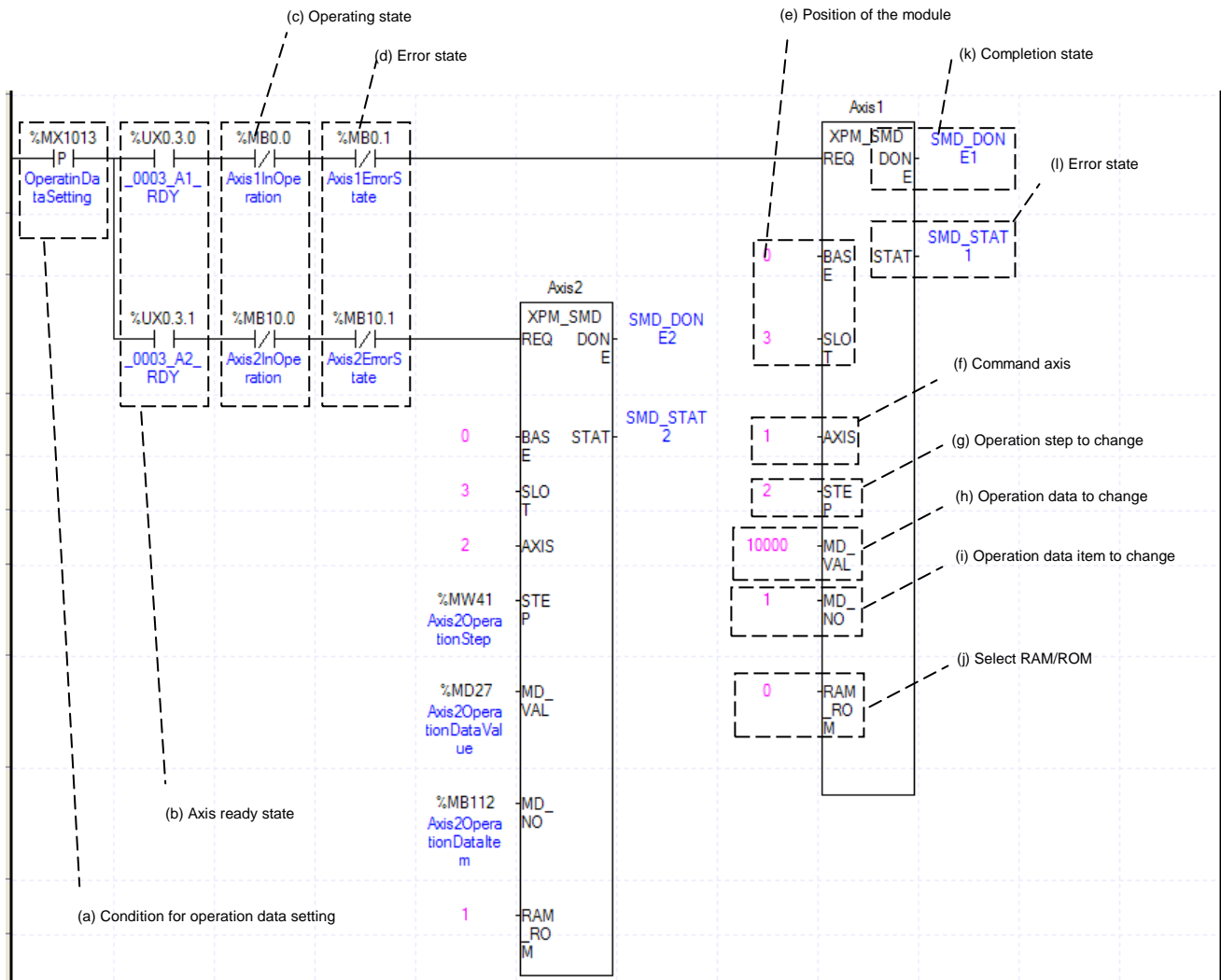

- (a) This is the condition for Operating Data Command
This is the condition for Operating Data Command (XPM_SMD)
- (b) Axis ready
If communication between the positioning module and the servo driver is normal, corresponding signal will be on.
- (c) Operating state by axis
According to exercise from “Chapter 8.2.2 Current State Reading,” it is a signal of “Operating” for each axis. It turns on when it is operating. Operating Data Setting can not be configured while it is running hence configuration will only be configured when it is not running. Operation data setting command is available to be executed when the axis is operating. However, if operation data of the step that is currently operated are changed, those changes are reflected after the current step is completed.
- (d) Error state for each axis
According to exercise from “Chapter 8.2.2 Current State Reading,” it is a signal of “Error state” for each axis. It turns on when an error occurred. Operation will only work when there is no error. If you want to operate a system regardless of errors, you can just inactivate the function.
- (e) Address of Positioning Module
In this example, Positioning Module is installed at the 3 slot of 0 bases.
- (f) Axis of command execution
You can set an axis for Parameter Setting. XBF-PN04(8)B supports for 4(8) axes. In the “execution of axis” from the configuration of Parameter Setting, you can set a value for axis1 through axis4(8).

(g) Operation data step to change

Set the operation data step no. to change with operation data setting command. XBF-PN04B/PN08B can set 400 step operation data per each axis and the data would be 0 to 400. If the data is set as "0", it means "Current step" of operation data of corresponding axis.

(h) Operation data value to change

Set the value of operation data to change.

(i) List of Changing Parameter

You need to set a list for parameter (h) changing from set command. Once operating is working, this value will change to parameter (h). Each value of Operating Data is listed below. For example if you put 1000 for value of Changing Operating Data and 4 for Operating data then the value of Dwell is going to be set as 1000ms.

Setting value	Operation Data
1	Goal position
2	Circle interpolation support position
3	Operation speed
4	Dwell time
5	M code No.
6	Second axis setting
7	Helical interpolation axis
8	Count for circle interpolation turn
9	Coordinate
10	Control method
11	Operation method
12	Operation pattern
13	Size of circle
14	Acceleration No.
15	Deceleration No.
16	Circle interpolation method
17	Circle interpolation direction

(j) ROM/RAM Setting

This function sets whether you save value of changing parameter to Rom or Ram. If you choose Rom the data will be saved regardless of power and if you save in the ram the data will be vanished when powers off. This parameter sets as 1 means Rom saved, and sets as 0 means Ram saved. There is no limitation of saving parameters in the Rom since parameter of Positioning Module saved in the MRAM.

(k) State of Operation complete

If function block is completed without error, "1" will be outputted and maintain "1" until the next operation. If error occurred, "0" will be outputted.

(l) Error State

This is the area that output error no. if there are errors in operation of function block.

(m) Execution content of each function block is as follows.

Operation data setting for axis1 : RAM Setting the goal position on step no.2 of axis1 operation data as 10000.
 Operation data setting for axis2 : ROM Setting %MB112(Operation data item of axis2) of axis2 operation data %MW41(Operation step of axis2) step as %MD27(Operation data value of axis2).

(3) Operation Data Teaching Array

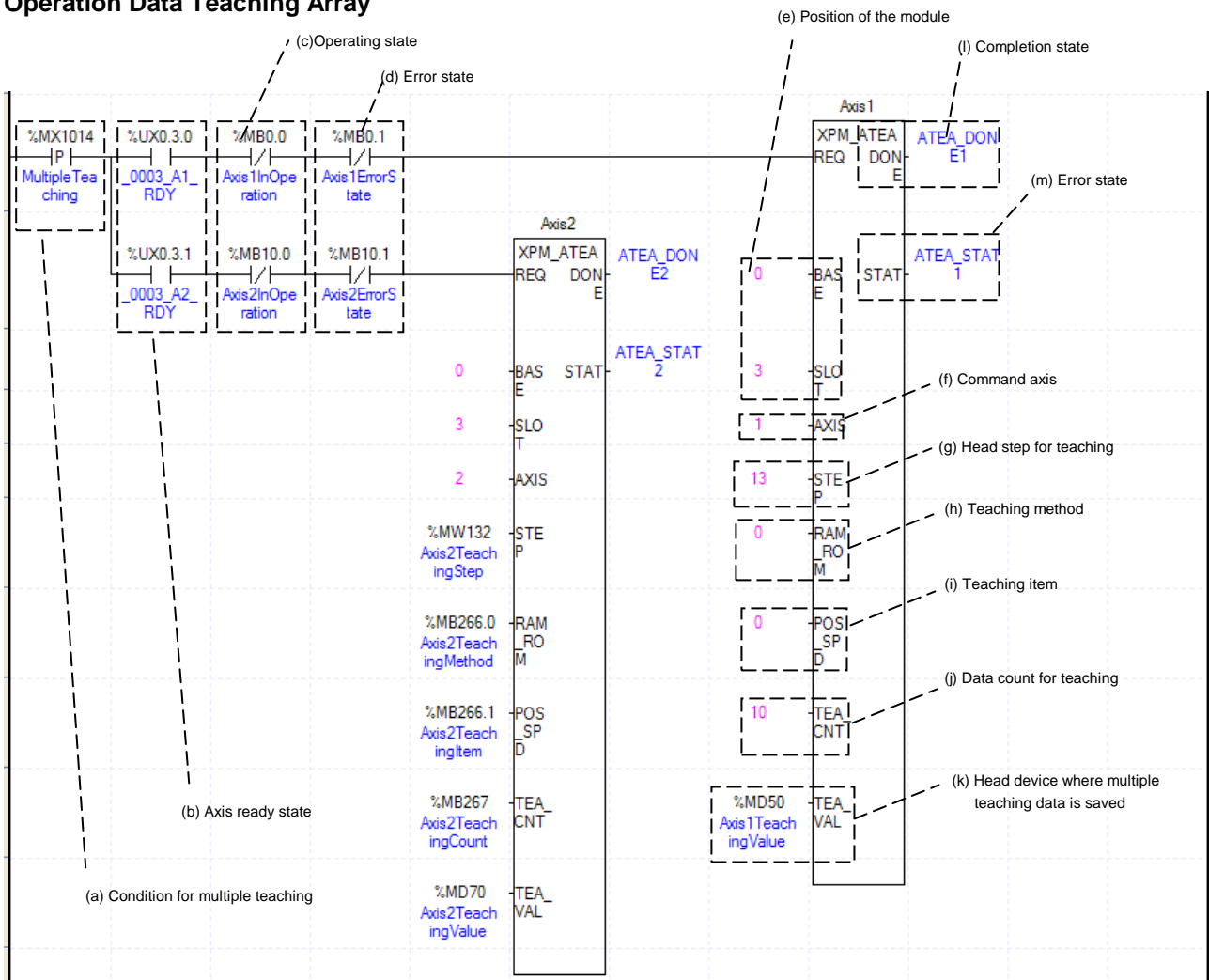

- (a) This is the condition for Teaching Array
Condition Teaching Array Command (XPM_ATEA)
- (b) Axis ready
If communication between the positioning module and the servo driver is normal, corresponding signal will be on.
- (c) Operating state by axis
According to exercise from “Chapter 8.2.2 Current State Reading,” it is a signal of “Operating” for each axis. It turns on when it is operating. Teaching Array can not be configured while it is running hence configuration will only be configured when it is not running. Even though teaching can be performed even when the axis subject to teaching is being operated but, only the current step’s data is reflected after the current step operation is completed if the step that is currently running is within the step area while other steps’ data are immediately changed.
- (d) Error state for each
According to exercise from “Chapter 8.2.2 Current State Reading,” it is a signal of “Error state” for each axis. It turns on when an error occurred. Operation will only work when there is no error. If you want to operate a system regardless of errors, you can just inactivate the function.
- (e) Address of Positioning Module
In this example, Positioning Module is installed at the 3 slot of 0 bases.
- (f) Axis of command execution
You can set an axis for Parameter Setting. XBF-PN04(8)B supports for 4(8) axes. In the “execution of axis” from the configuration of Parameter Setting, you can set a value for axis1 through axis4(8).
- (g) First number of Teaching Step

You can setup the first number of Teaching Step among the Operating Data step. In this example above, Teaching Array of axis1 will be operate from 22th step, which is 10th step away from 13th step, hence it will be operate between 13th step and 22th step.

(h) Teaching Method

This function sets whether you save value of changed Teaching data to Rom or Ram. If you choose Rom the data will be saved regardless of power and if you save in the ram the data will be vanished when powers off. This parameter sets as 1 means Rom saved, and sets as 0 means Ram saved. There is no limitation of saving parameters in the Rom since parameter of Positioning Module saved in the MRAM.

(i) List of Teaching

You can set a data with Teaching Method among the Operating Data. Both "Goal Position" and "Operating Speed" can be changed by Teaching Array. When its value set "0" means set a Goal Position and "1" means set an Operating Speed.

(j) Amount of Teaching

Decide how many steps will be operated using by Teaching Method. Maximum 16 Teaching Array data can be used. For more information about Teaching Array Operation, look for reference from "Chapter 7.4.8"

(k) Address of first device where those data for Teaching Array are saved

To execute a Teaching Array, you need to set a specific value first. TWR commands are using for set up those Teaching Array data. It has to be done before actual Teaching Array operation. Teaching Data will be set up depends on number of first device as below table.

Value	Device No.	Teaching Array Data
1	Device + 0	Teaching Array Data 1
2	Device + 1	Teaching Array Data 2
3	Device + 2	Teaching Array Data 3
4	Device + 3	Teaching Array Data 4
5	Device + 4	Teaching Array Data 5
6	Device + 5	Teaching Array Data 6
7	Device + 6	Teaching Array Data 7
8	Device + 7	Teaching Array Data 8
9	Device + 8	Teaching Array Data 9
10	Device + 9	Teaching Array Data 10
11	Device + 10	Teaching Array Data 11
12	Device + 11	Teaching Array Data 12
13	Device + 12	Teaching Array Data 13
14	Device + 13	Teaching Array Data 14
15	Device + 14	Teaching Array Data 15
16	Device + 15	Teaching Array Data 16

(l) State of Operation complete

If function block is completed without error, "1" will be outputted and maintain "1" until the next operation. If error occurred, "0" will be outputted.

(m) Error State

This is the area that output error no. if there are errors in operation of function block.

(n) Execution content of each function block is as follows.

Axis1 Teaching Array : Execute RAM Teaching the position value of 10 steps from no.13 to no.22 of axis1 as the value saved in %MD50 ~ %MD59.

Axis2 Teaching Array : Teaching the items of 2axis(from %MW132~%MB2666.1) as the value saved in that from %MD70 to MB267 by %MB266.0

(4) Saving Current Data

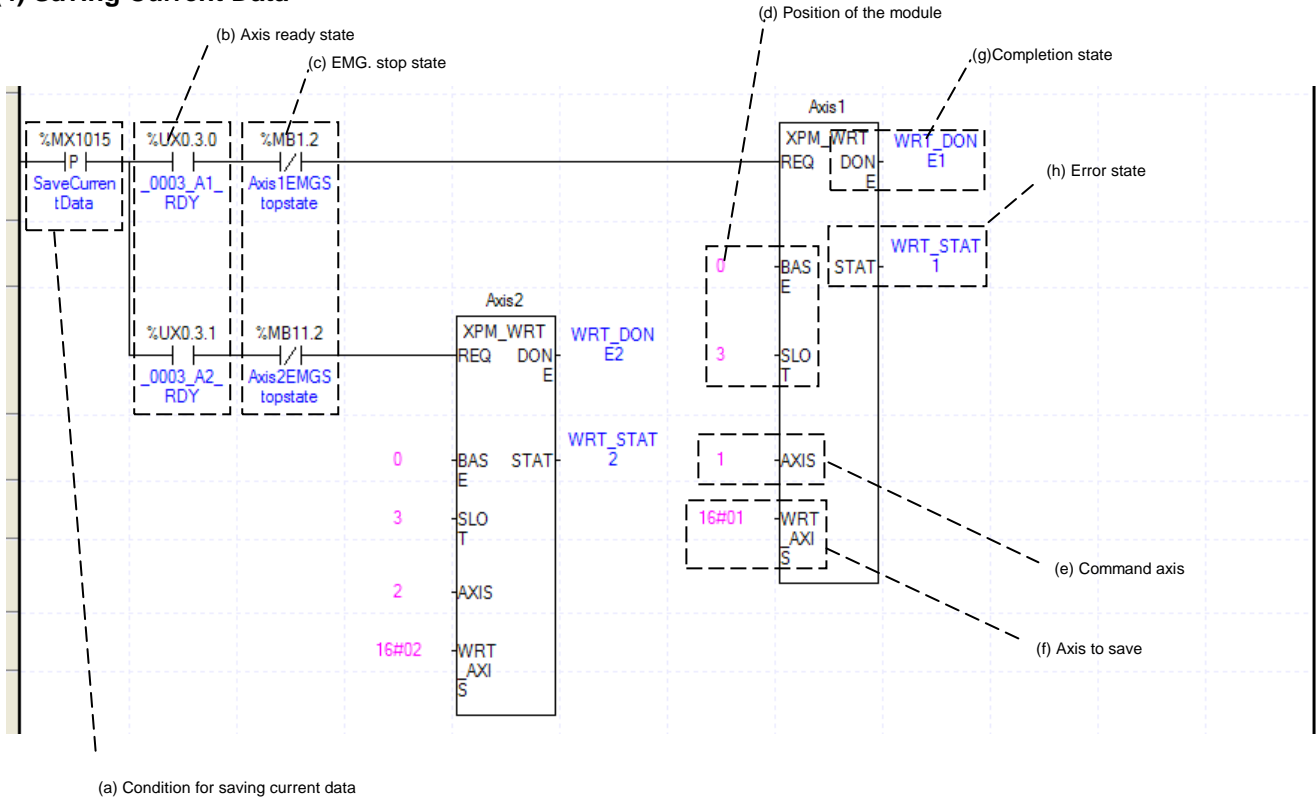

- (a) This is the condition for Saving Current Data
This is the condition for Saving Current Data Command (XPM_WRT). When current saving data operated, those values of module parameter and operating data would be saved in MRAM. Therefore configuration of Ram or Ram Teaching would be constantly saved whether power is on or not.
- (b) Axis ready
If communication between the positioning module and the servo driver is normal, corresponding signal will be on.
- (c) Emergency Stop by each axis
According to exercise from "Chapter 8.2.2 Current State Reading," it is a signal of "State of Emergency Stop" for each axis. It turns on when it is Emergency Stop. Emergency Stop can not be configured while it is running hence configuration will only be configured when it is not running.
- (d) Address of Positioning Module
In this example, Positioning Module is installed at the 3 slot of 0 bases.
- (e) Axis of command execution
You can set an axis for Parameter Setting. XBF-PN04(8)B supports for 4(8) axes. In the "execution of axis" from the configuration of Parameter Setting, you can set a value for axis1 through axis4(8).
- (f) Saving by axis
Configure current data operation setting. Choosing axis are configured follow by below table. Therefore even if those axis are not operated as it programmed, saving axis can be saved in Array. The data of operated axis saved in MRAM, which make constantly stable whether its power is on or not.
- (g) State of Operation complete
If function block is completed without error, "1" will be outputted and maintain "1" until the next operation. If error occurred, "0" will be outputted.
- (h) Error State
This is the area that output error no. if there are errors in operation of function block.

8.2.6 Positioning Operation

(1) Homing

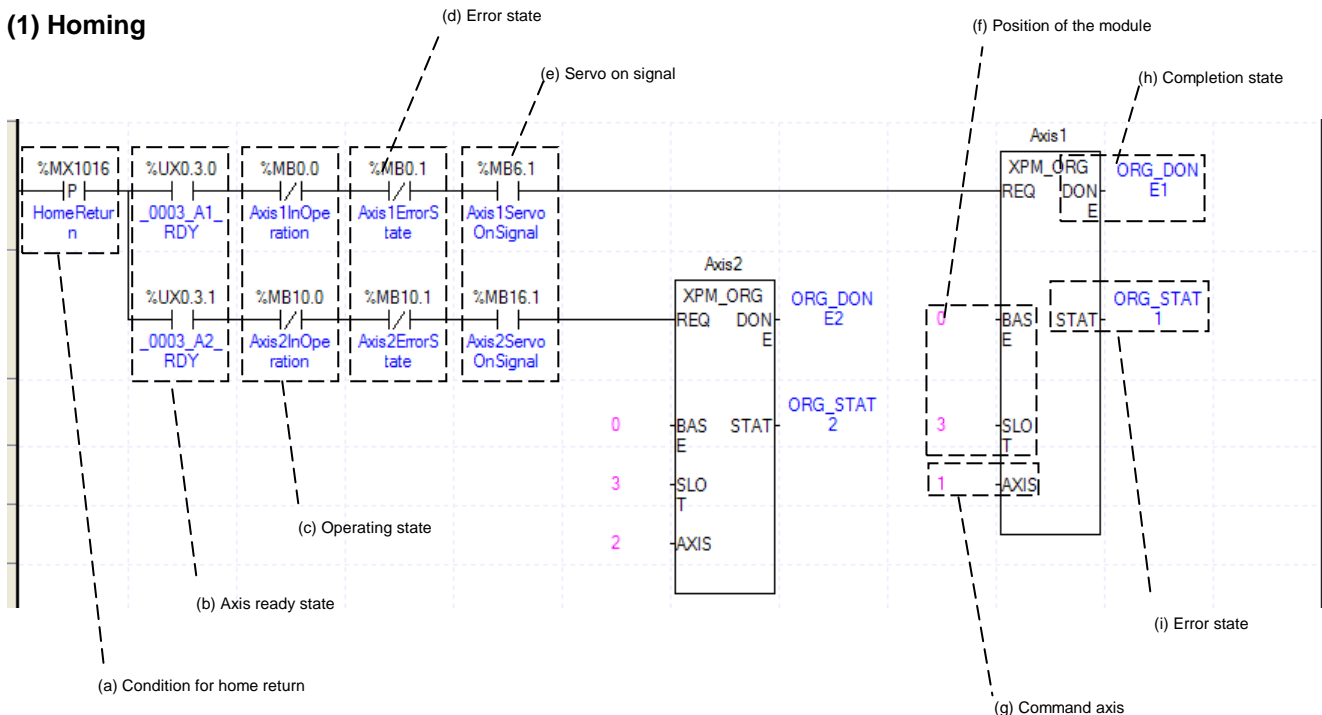

- (a) This is the condition for Homing
This is the condition for Homing Command (XPM_ORG)
- (b) Axis ready
If communication between the positioning module and the servo driver is normal, corresponding signal will be on.
- (c) Operating state by axis
According to exercise from “Chapter 8.2.2 Current State Reading,” it is a signal of “Operating” for each axis. It turns on when it is operating. Homing command can not be configured while it is running hence configuration will only be configured when it is not running. If you execute Homing while it is running, the “error 201” would be appeared.
- (d) Error state for each axis
According to exercise from “Chapter 8.2.2 Current State Reading,” it is a signal of “Error state” for each axis. It turns on when an error occurred. Operation will only work when there is no error. If you want to operate a system regardless of errors, you can just inactivate the function.
- (e) Servo On signal
When applying the example program of “8.2.2 Current State Read”, this is “Servo On” signal for each axis. When each axis is Servo On state, it will be on. Since “Home return” command can’t be executed when the axis is not servo on, it makes command executed when servo driver is “Servo On” state. If you execute “Home return” command when axis is not Servo On state, the error 203 occurs.
- (f) Address of Positioning Module
In this example, Positioning Module is installed at the 3 slot of 0 bases.
- (g) Axis of command execution
You can set an axis for Inching Operation. XBF-PN04(8)B supports for 4(8) axes. In the “execution of axis” from the configuration of Manual Operation, you can set a value for axis1 through axis4(8).
- (h) State of Operation complete
If function block is completed without error, “1” will be outputted and maintain “1” until the next operation. If error occurred, “0” will be outputted.
- (i) Error State
This is the area that output error no. if there are errors in operation of function block.
- (j) For more information, reference for Homing is in the “Chapter 9.1.”

(2) Direct Start

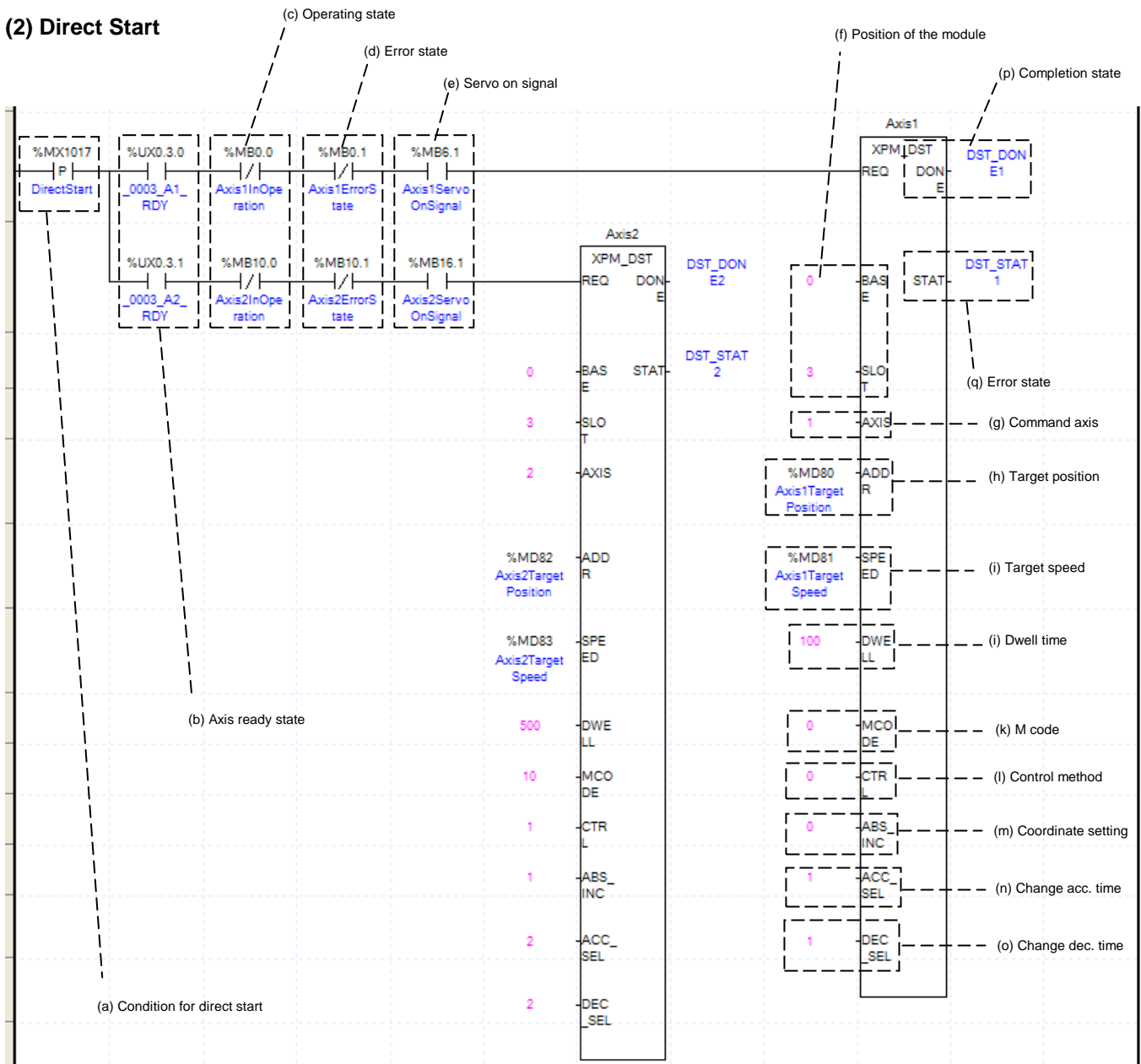

- (a) This is the condition for Direct Start
This is the condition for Direct Start Command (XPM_DST)
- (b) Axis ready
If communication between the positioning module and the servo driver is normal, corresponding signal will be on.
- (c) Operating state by axis
According to exercise from "Chapter 8.2.2 Current State Reading," it is a signal of "Operating" for each axis. It turns on when it is operating. Direct Start command can not be configured while it is running hence configuration will only be configured when it is not running. If you execute Direct Start while it is running, the "error 221" would be appeared.
- (d) Error state for each axis
According to exercise from "Chapter 8.2.2 Current State Reading," it is a signal of "Error state" for each axis. It turns on when an error occurred. Operation will only work when there is no error. If you want to operate a system regardless of errors, you can just inactivate the function.

- (e) Servo On signal
When applying the example program of “8.2.2 Current State Read”, this is “Servo On” signal for each axis. When each axis is Servo On state, it will be on. Since “Direct start” command can’t be executed when the axis is not servo on, it makes command executed when servo driver is “Servo On” state. If you execute “Direct start” command when axis is not Servo On state, the error 212 occurs.
- (f) Address of Positioning Module
In this example, Positioning Module is installed at the 3 slot of 0 bases.
- (g) Axis of command execution
You can set an axis for Inching Operation. XBF-PN04(8)B supports for 4(8) axes. In the “execution of axis” from the configuration of Manual Operation, you can set a value for axis1 through axis4(8).
- (h) Goal of Direct Start
Decide changing position of Direct Start command. In this example above, the initialized value is “device,” but you can also change it with “real numbers,” which data type is “DINT.”
- (i) Speed of Direct Start
Decide goal speed of Direct Start. In this example above, the initialized value is “device,” but you can also change it with “real numbers,” which data type is “UDINT.”
- (j) Dwell Time of Direct Start
Dwell Time consider as a total amount of time from beginning of Direct Start operation that reach to the goal position and make output of Positioning Done Signal. That means after done its operation, direct Start will make a Positioning done signal. Its unit is “ms,” and type is “UINT”
- (k) Direct Start M code
You can set a value of M code which are displaying of Operating Parameter by Direct Start. The way of M code outputs are “Parameter Expansion, M code Mode,” within the “None, With, After.” It will make an M code besides you choose “None” for its parameter. For more information, reference for M code is in the “Chapter 4.2.2”
- (l) Control method
Set direct start. Follows are executed depending on setting value.
0 : Position control
1 : Speed control
2 : Feed control
3: Shortest position control
- (m) Coordinates setting
Set the operating coordinates of direct start. Followings are executed depending on setting value.
0 : Absolute coordinates
1 : Relative coordinates
- (n) Acceleration No.
Set the acc. No. used in positioning control. It operates by corresponding acc. Time of basic parameter depending on setting value.
0 : Acc. Time 1
1 : Acc. Time 2
2 : Acc. Time 3
3 : Acc. Time 4
- (o) Deceleration No.
Set the dec. No. used in positioning control. It operates by corresponding dec. Time of basic parameter depending on setting value.
0 : Dec. Time 1
1 : Dec. Time 2
2 : Dec. Time 3
3 : Dec. Time 4
- (p) State of Operation complete
If function block is completed without error, “1” will be outputted and maintain “1” until the next operation. If error occurred, “0” will be outputted.
- (q) Error State
This is the area that output error no. if there are errors in operation of function block.

(r) The function block used in the example is as follows.

Axis1 Direct Start : Execute position control with Axis1 Goal Position %MD80(axis1 Goal position), Goal Speed %MD81(axis Goal Speed), Dwell time 100ms, M code 0, Absolute coordinates, Acc. Time1, Dec Time 1

Axis2 Direct Start : Execute position control with Axis1 Goal Position %MD82(axis2 Goal position), Goal Speed %MD83(axis2 Goal Speed), Dwell time 500ms, M code 0, Absolute coordinates, Acc. Time 2, Dec Time 2

(3) Indirect Start

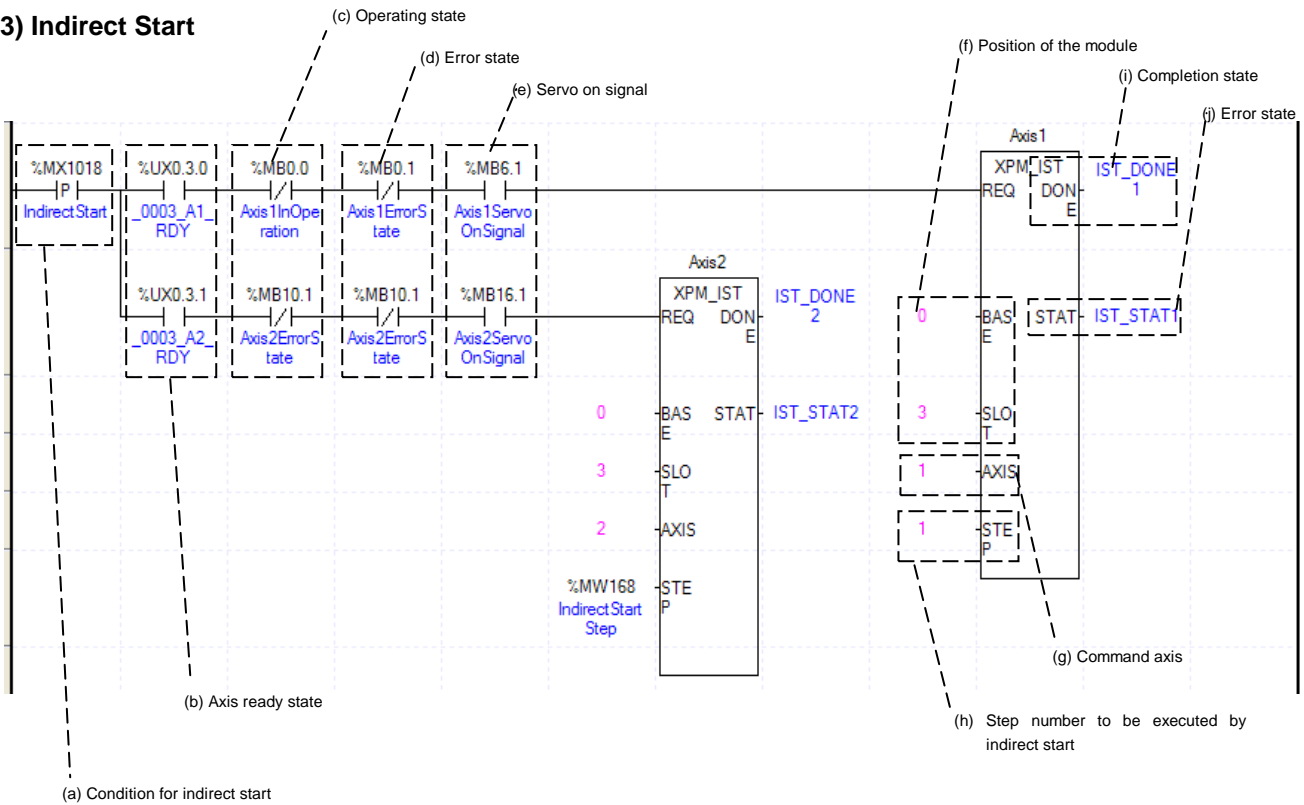

- (a) This is the condition for Indirect Start
This is the condition for Indirect Start Command (XPM_IST)
- (b) Axis ready
If communication between the positioning module and the servo driver is normal, corresponding signal will be on.
- (c) Operating state by axis
According to exercise from “Chapter 8.2.2 Current State Reading,” it is a signal of “Operating” for each axis. It turns on when it is operating. Operating Data Setting can not be configured while it is running hence configuration will only be configured when it is not running. If you execute Indirect Start while it is running, the “error 231” would be appeared.
- (d) Error state for each axis
According to exercise from “Chapter 8.2.2 Current State Reading,” it is a signal of “Error state” for each axis. It turns on when an error occurred. Operation will only work when there is no error. If you want to operate a system regardless of errors, you can just inactivate the function.
- (e) Servo On signal
When applying the example program of “8.2.2 Current State Read”, this is “Servo On” signal for each axis. When each axis is Servo On state, it will be on. Since “Indirect start” command can’t be executed when the axis is not servo on, it makes command executed when servo driver is “Servo On” state. If you execute “Indirect start” command when axis is not Servo On state, the error 212 occurs.
- (f) Address of Positioning Module
In this example, Positioning Module is installed at the 3 slot of 0 bases.

- (g) Axis of command execution
You can set an axis for Parameter Setting. XBF-PN04(8)B supports for 4(8) axes. In the “execution of axis” from the configuration of Parameter Setting, you can set a value for axis1 through axis4(8).
- (h) Operating step number by Indirect Start
Set the operating step number by indirect start for main Axis of command execution.
- (i) State of Operation complete
If function block is completed without error, “1” will be outputted and maintain “1” until the next operation. If error occurred, “0” will be outputted.
- (j) Error State
This is the area that output error no. if there are errors in operation of function block.
- (k) Indirect start operates by appointing step of position data for each axis. Therefore it could run those commands of Positioning control, Speed control, Feed control, Linear circular interpolation depends on setting of positioning data. For more information, reference for Setting of Operating Data is in the “Chapter4.6.”
- (l) The operation of function block is as follows.
Axis1 Indirect Start : Execute step no.1 of axis1 by indirect start
Axis2 Indirect Start : Execute %MW168(Indirect start step) of axis2 by indirect start

(4) Ellipse Interpolation

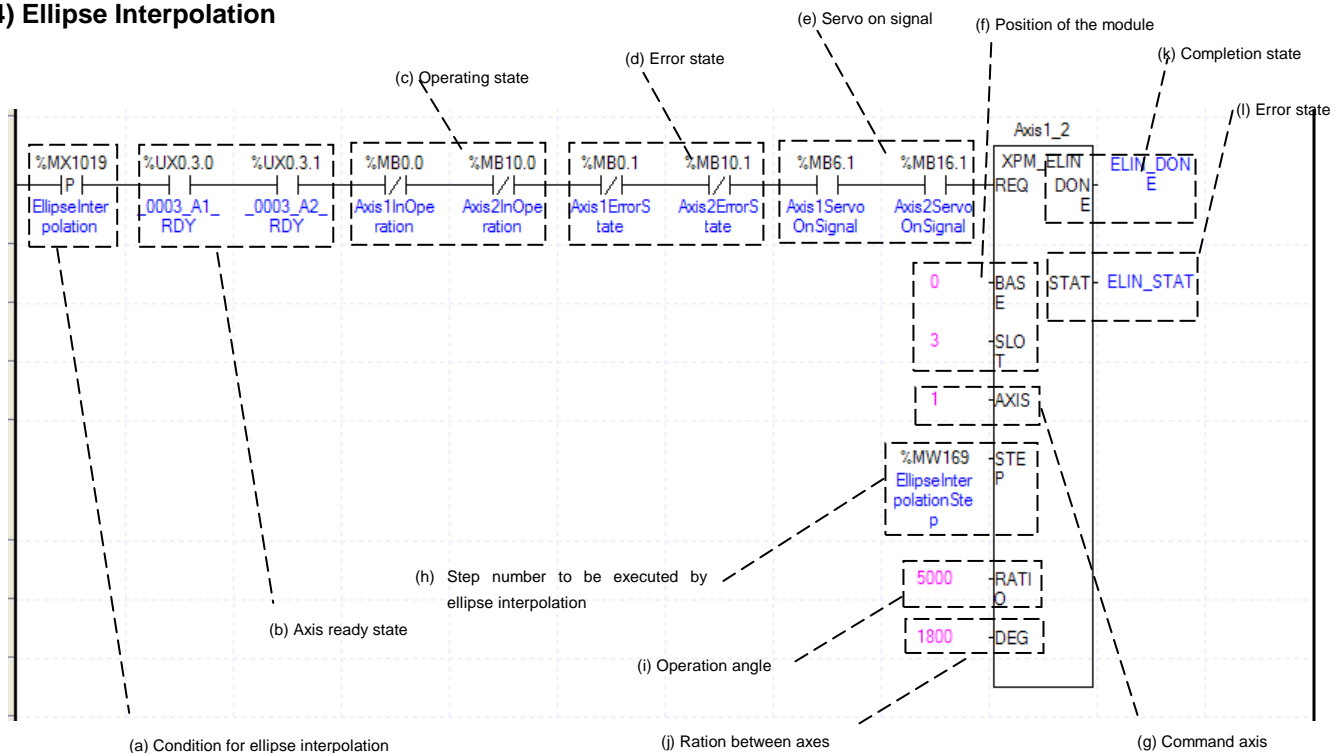

- (a) This is the condition for Ellipse Interpolation
This is the condition for Ellipse Interpolation Command (XPM_ELIN)
- (b) Axis ready
If communication between the positioning module and the servo driver is normal, corresponding signal will be on.
- (c) Operating state by axis
According to exercise from “Chapter 8.1.2 Current State Reading,” it is a signal of “Operating” for each axis. It turns on when it is operating. Operating Data Setting can not be configured when it is not running. If you execute Ellipse Interpolation while it is running, the “error 541” would be appeared.
- (d) Error state for each axis
According to exercise from “Chapter 8.1.2 Current State Reading,” it is a signal of “Error state” for each axis. It turns on when an error occurred. Operation will only work when there is no error. If you want to operate a system regardless of errors, you can just inactivate the function.

(e) Servo On signal

When applying the example program of “8.2.2 Current State Read”, this is “Servo On” signal for each axis. When each axis is Servo On state, it will be on. Since “Ellipse interpolation” command can’t be executed when the axis is not servo on, it makes command executed when servo driver is “Servo On” state. If you execute “Ellipse interpolation” command when axis is not Servo On state, the error 549 occurs.

(f) Address of Positioning Module

In this example, Positioning Module is installed at the 3 slot of 0 bases.

(g) Axis of command execution

You can set an axis for Parameter Setting. XBF-PN04(8)B supports for 4(8) axes. In the “execution of axis” from the configuration of Parameter Setting, you can set a value for axis1 through axis4(8).

(h) Operating step number by Ellipse Interpolation

Set the operating step number by Ellipse Interpolation. The setting of main operating step and subordinate step is the same.

(i) Ratio of Ellipse Interpolation Axis

Set both ratio values for main and subordinate axis of set operates data from circular interpolation locus. It is to change circular locus into ellipse locus by using ratio of main and subordinate axis.

(j) Angle of Ellipse Interpolating Operation

Set the degree for Ellipse Interpolating Operation. Unit is [$X10^{-1}$ degree]. For more information, reference for Ellipse Interpolation is in the “Chapter9.213.”

(k) State of Operation complete

If function block is completed without error, “1” will be outputted and maintain “1” until the next operation. If error occurred, “0” will be outputted.

(l) Error State

This is the area that output error no. if there are errors in operation of function block.

(m) The function block used in the example is as follows.

Axis1_2 Ellipse interpolation: Execute ellipse interpolation of 180°, ratio of between axis as 50% with operation data of %MW169(Ellipse interpolation step)step.

(5) Synchronous Start

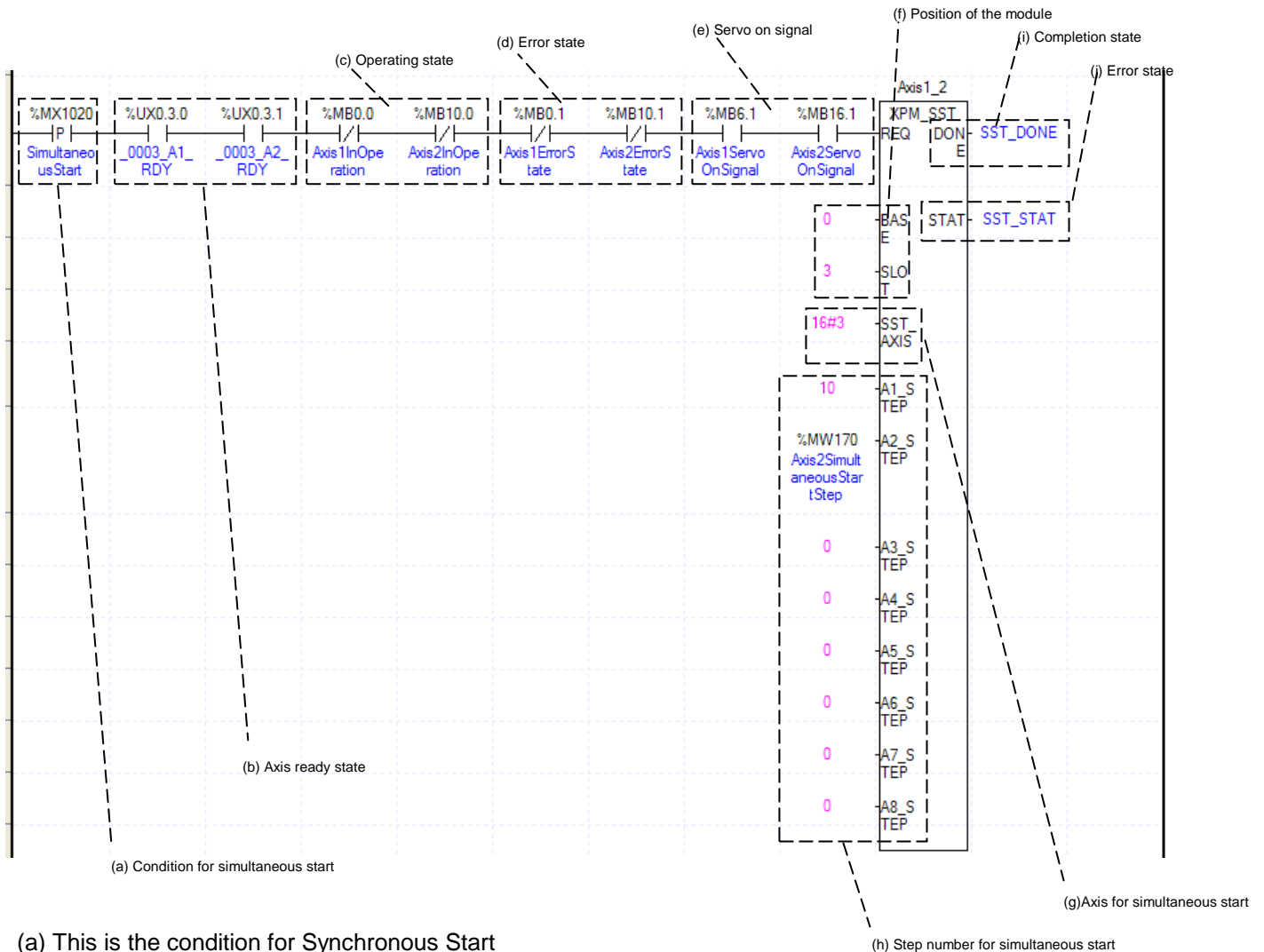

(a) This is the condition for Synchronous Start
This is the condition for Synchronous Start Command

(b) Axis ready
If communication between the positioning module and the servo driver is normal, corresponding signal will be on.

(c) Operating state by axis
According to exercise from “Chapter 8.2.2 Current State Reading,” it is a signal of “Operating” for each axis. It turns on when it is operating. Operating Data Setting can not be configured while it is running hence configuration will only be configured when it is not running. If you execute Axis1 Synchronous Start while it is running, the “error 291” would be appeared.

(d) Error state by axis
According to exercise from “Chapter 8.2.2 Current State Reading,” it is a signal of “Error state” for each axis. It turns on when an error occurred. Operation will only work when there is no error. If you want to operate a system regardless of errors, you can just inactivate the function.

(e) Servo On signal
When applying the example program of “8.2.2 Current State Read”, this is “Servo On” signal for each axis. When each axis is Servo On state, it will be on. Since “Simultaneous start” command can’t be executed when the axis is not servo on, it makes command executed when servo driver is “Servo On” state. If you execute simultaneous start” command when axis is not Servo On state, the error 295 occurs.

(f) Address of Positioning Module

In this example, Positioning Module is installed at the 3 slot of 0 bases.

(g) Axis for Synchronous Start

Set axis for Synchronous Start. The axis for Synchronous Start uses a "bit" from WORD Data setting as a "1" for each axis. Axis for each bits are as below.

15~8 Bit	7Bit	6Bit	5Bit	4Bit	3Bit	2Bit	1Bit	0Bit
N/A	Axis 8	Axis 7	Axis 6	Axis 5	Axis 4	Axis 3	Axis 2	Axis 1

(h) Synchronous start step no. per each axis

Set the step no. of each axis for synchronous start. XBF-PN04B/PN08B can control 4 axes, it doesn't use A4_STEP ~ A8_STEP input.

(i) State of Operation complete

If function block is completed without error, "1" will be outputted and maintain "1" until the next operation. If error occurred, "0" will be outputted.

(j) Error State

This is the area that output error no. if there are errors in operation of function block.

(k) The function block used in the example is as follows.

Axis1_2 Synchronous start: Execute no.10 operation step of axis1 and step of %MW170(axis2 synchronous start step) synchronously.

(6) Point Operation

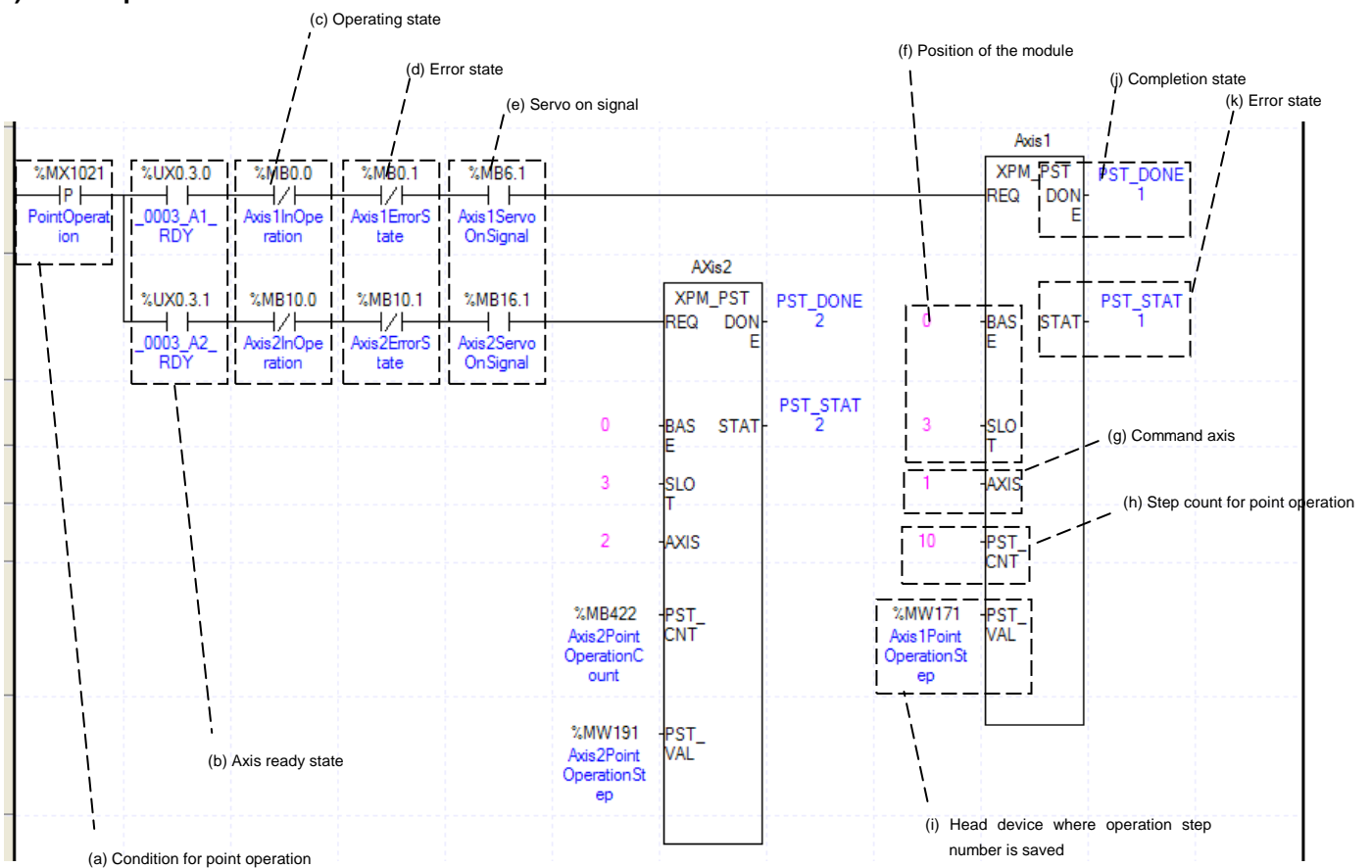

(a) This is the condition for Point Operation

This is the condition for Point Operation Command (XPM_PST).

(b) Axis ready

If communication between the positioning module and the servo driver is normal, corresponding signal will be on.

(c) Operating state by axis

According to exercise from “Chapter 8.2.2 Current State Reading,” it is a signal of “Operating” for each axis. It turns on when it is operating. Operating Data Setting can not be configured while it is running hence configuration will only be configured when it is not running. If you execute Point Operation while it is running, the “error 231” would be appeared.

(d) Error state for each axis

According to exercise from “Chapter 8.2.2 Current State Reading,” it is a signal of “Error state” for each axis. It turns on when an error occurred. Operation will only work when there is no error. If you want to operate a system regardless of errors, you can just inactivate the function.

(e) Servo On signal

When applying the example program of “8.2.2 Current State Read”, this is “Servo On” signal for each axis. When each axis is Servo On state, it will be on. Since “Point operation” command can’t be executed when the axis is not servo on, it makes command executed when servo driver is “Servo On” state. If you execute “Point operation” command when axis is not Servo On state, the error 212 occurs.

(f) Address of Positioning Module

In this example, Positioning Module is installed at the 3 slot of 0 bases.

(g) Axis of command execution

You can set an axis for Parameter Setting. XBF-PN04(8)B supports for 4(8) axes. In the “execution of axis” from the configuration of Parameter Setting, you can set a value for axis1 through axis4(8).

(h) Amount of Point Operation Steps

Decide how many steps will be operated. In this example above, 10 Point Operation steps are set in the axis1. Therefore, the step no. saved in %MW171 ~ %MW180 will be executed by point operation. For the details about point operation, refer to “(4) Point operation” of “9.2.17 Positioning start”.

(i) Address of first device where those data for Step Numbers of Point Operation are saved

To execute a Point Operation, you need to set a specific value first. Point Operation Step Data will be set up depends on number of first device as below table.

Value	Device No.	Point Operating Step Data
1	Device + 0	Point Operating Step Data 1
2	Device + 1	Point Operating Step Data 2
3	Device + 2	Point Operating Step Data 3
4	Device + 3	Point Operating Step Data 4
5	Device + 4	Point Operating Step Data 5
6	Device + 5	Point Operating Step Data 6
7	Device + 6	Point Operating Step Data 7
8	Device + 7	Point Operating Step Data 8
9	Device + 8	Point Operating Step Data 9
10	Device + 9	Point Operating Step Data 10
11	Device + 10	Point Operating Step Data 11
12	Device + 11	Point Operating Step Data 12
13	Device + 12	Point Operating Step Data 13
14	Device + 13	Point Operating Step Data 14
15	Device + 14	Point Operating Step Data 15
16	Device + 15	Point Operating Step Data 16
17	Device + 16	Point Operating Step Data 17
18	Device + 17	Point Operating Step Data 18
19	Device + 18	Point Operating Step Data 19
20	Device + 19	Point Operating Step Data 20

(j) State of Operation complete

If function block is completed without error, “1” will be outputted and maintain “1” until the next operation. If error occurred, “0” will be outputted.

(k) Error State

This is the area that output error no. if there are errors in operation of function block.

(7) Speed Synchronization

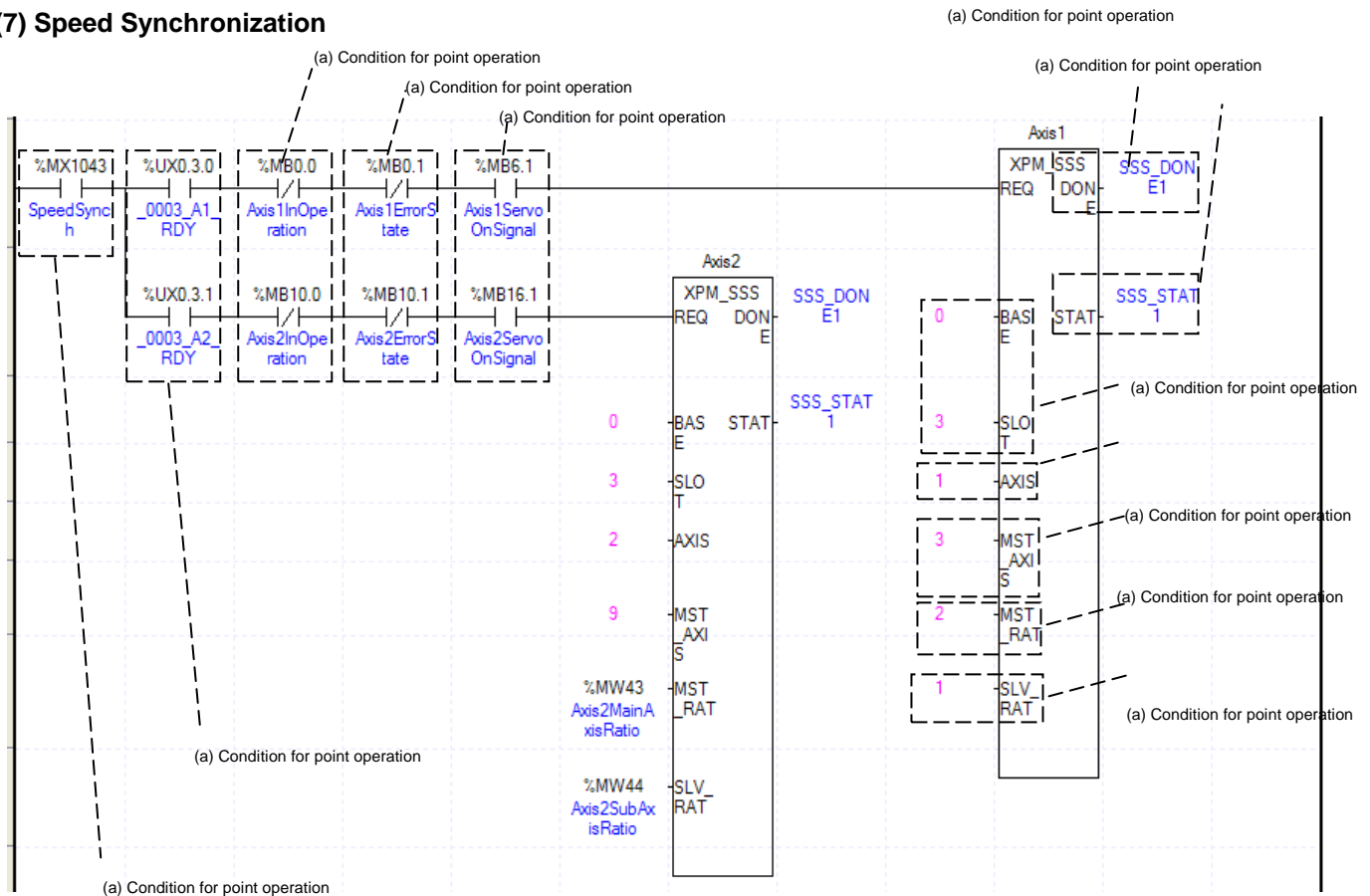

- (a) This is the condition for Speed Synchronization
This is the condition for Speed Synchronization Command (XPM_SSS)
- (b) Axis ready
If communication between the positioning module and the servo driver is normal, corresponding signal will be on.
- (c) Operating state by axis
According to exercise from “Chapter 8.1.2 Current State Reading,” it is a signal of “Operating” for each axis. It turns on when it is operating. Operating Data Setting can not be configured while it is running hence configuration will only be configured when it is not running. If you execute Speed Synchronization while it is running, the “error 351” would be appeared.
- (d) Error state for each axis
According to exercise from “Chapter 8.1.2 Current State Reading,” it is a signal of “Error state” for each axis. It turns on when an error occurred. Operation will only work when there is no error. If you want to operate a system regardless of errors, you can just inactivate the function.
- (e) Servo On signal
When applying the example program of “8.2.2 Current State Read”, this is “Servo On” signal for each axis. When each axis is Servo On state, it will be on. Since “Speed synchronization” command can’t be executed when the axis is not servo on, it makes command executed when servo driver is “Servo On” state. If you execute “Speed synchronization” command when axis is not Servo On state, the error 354 occurs.
- (f) Address of Positioning Module
In this example, Positioning Module is installed at the 3 slot of 0 bases.
- (g) Axis of command execution
You can set an axis for Parameter Setting. XBF-PN04(8)B supports for 4(8) axes. In the “execution of axis” from the configuration of Parameter Setting, you can set a value for axis1 through axis4(8).
- (h) Main Axis Setting
Set a main axis to operate Speed Synchronization. This setting is for main axis of Speed Synchronization. This setting cannot be set as same value as Axis of command execution, and possible setting values are as below.

(i) Ratio of Main Axis

Set value for Ratio of Main Axis to execute a Speed Synchronization.

(j) Ratio of Subordinate Axis

Set value for Ratio of Subordinate Axis to execute a Speed Synchronization. In this example above, the ratio of main and subordinate axis is 2:1. Meaning that operational speed ratio of those axis is 2 to 1. So, if main axis is operating in speed of 10000, subordinate axis will be operating in speed of 5000.

Set value	Main Axis
1	Axis1
2	Axis 2
3	Axis 3
4	Axis 4
5	Axis 5
6	Axis 6
7	Axis 7
8	Axis 8
9	Encoder1

(k) State of Operation complete

If function block is completed without error, "1" will be outputted and maintain "1" until the next operation. If error occurred, "0" will be outputted.

(l) Error State

This is the area that output error no. if there are errors in operation of function block.

(m) For more information, reference for Speed Synchronization is in the "Chapter 9.4.1."

(8) Position Assign Speed Synchronization

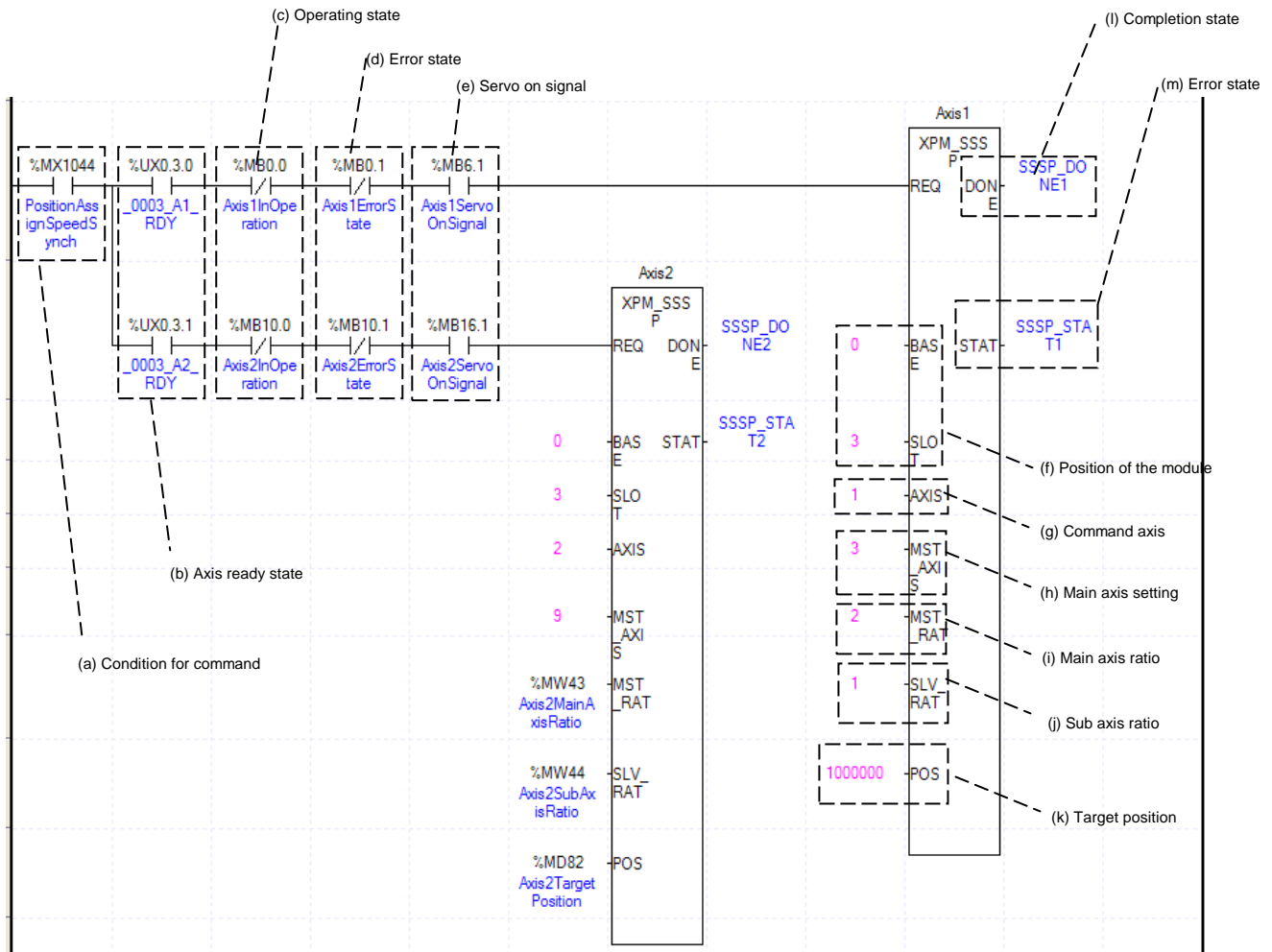

- (a) This is the condition for Position Assign Speed Synchronization
This is the condition for Position Assign Speed Synchronization Command (XPM_SSSP)
- (b) Axis ready
If communication between the positioning module and the servo driver is normal, corresponding signal will be on.
- (c) Operating state by axis
According to exercise from “Chapter 8.1.2 Current State Reading,” it is a signal of “Operating” for each axis. It turns on when it is operating. Operating Data Setting can not be configured while it is running hence configuration will only be configured if it is not running. If you execute Position Assign Speed Synchronization while it is running, the “error 351” would be appeared.
- (d) Error state for each axis
According to exercise from “Chapter 8.1.2 Current State Reading,” it is a signal of “Error state” for each axis. It turns on when an error occurred. Operation will only work when there is no error. If you want to operate a system regardless of errors, you can just inactivate the function.
- (e) Servo On signal
When applying the example program of “8.2.2 Current State Read”, this is “Servo On” signal for each axis. When each axis is Servo On state, it will be on. Since “Position assign speed synchronization” command can’t be executed when the axis is not servo on, it makes command executed when servo driver is “Servo On” state. If you execute “Position assign speed synchronization” command when axis is not Servo On state, the error 354 occurs.

(f) Address of Positioning Module

In this example, Positioning Module is installed at the 3 slot of 0 bases.

(g) Axis of command execution

You can set an axis for Parameter Setting. XBF-PN04(8)B supports for 4(8) axes. In the “execution of axis” from the configuration of Parameter Setting, you can set a value for axis1 through axis4(8).

(h) Main Axis Setting

Set a main axis to operate Speed Synchronization. This setting is for main axis of Speed Synchronization. This setting cannot be set as same value as Axis of command execution, and possible setting values are as below.

Set value	Main Axis
1	Axis1
2	Axis2
3	Axis3
4	Axis4
5	Axis5
6	Axis6
7	Axis7
8	Axis8
9	Encoder1

(i) Ratio of Main Axis

Set value for Ratio of Main Axis to execute a Speed Synchronization.

(j) Ratio of Subordinate Axis

Set value for Ratio of Subordinate Axis to execute a Speed Synchronization. In this example above, the ratio of main and subordinate axis is 2:1. Meaning that operational speed ratio of those axes are 2 to 1. So, if main axis is operating in speed of 10000, subordinate axis will be operating in speed of 5000.

(k) Goal Position

Set goal of Position Assign Speed Synchronization. Once Axis of command execution reaches the goal position, Speed Synchronization ends and operation will be stop immediately.

(l) State of Operation complete

If function block is completed without error, “1” will be outputted and maintain “1” until the next operation. If error occurred, “0” will be outputted.

(m) Error State

This is the area that output error no. if there are errors in operation of function block.

(n) For more information, reference for Position Assign Speed Synchronization is in the “Chapter 9.4.1.”

(9) Synchronous Start by Position

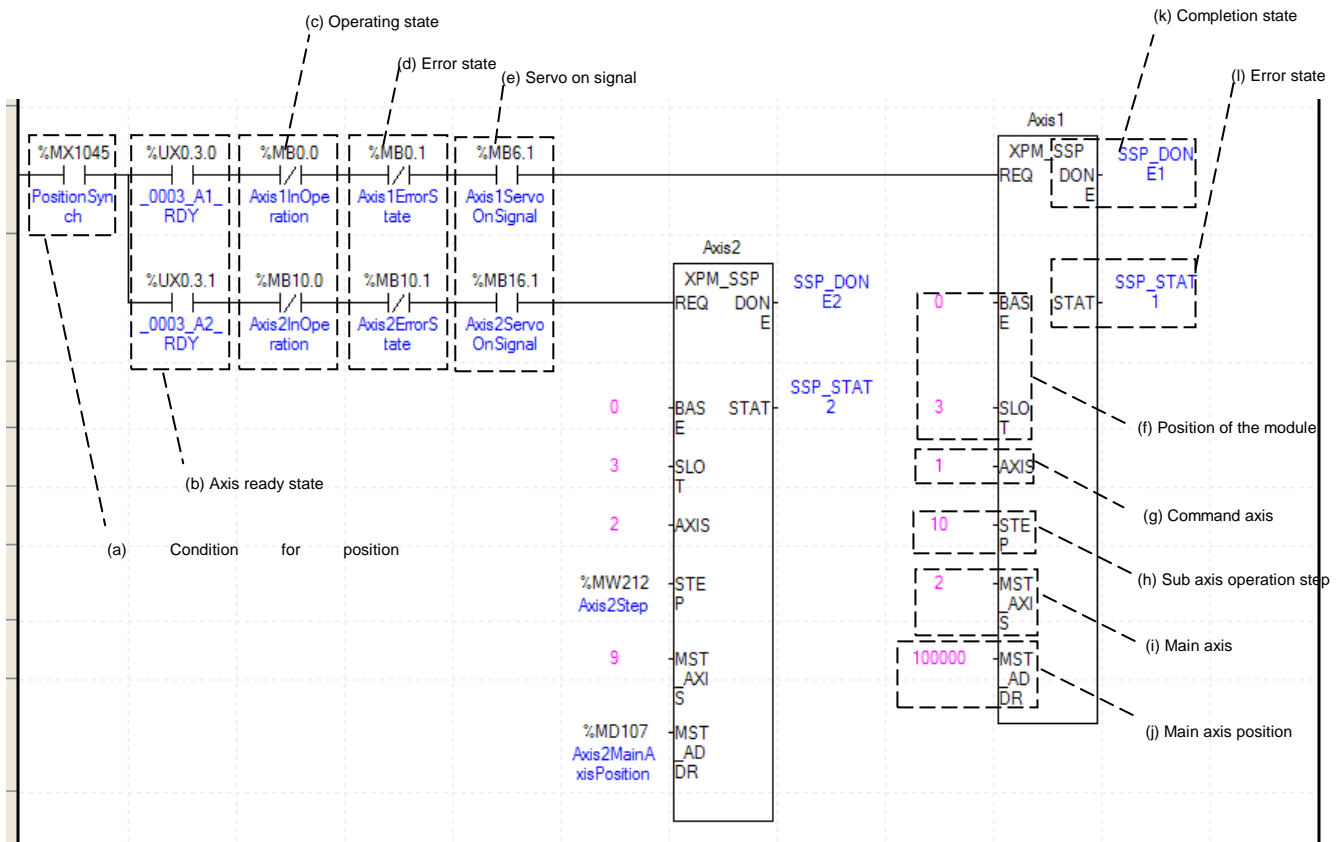

- (a) This is the condition for Synchronous Start by Position
This is the condition for Synchronous Start by Position Command (XPM_SSP)
- (b) Axis ready
If communication between the positioning module and the servo driver is normal, corresponding signal will be on.
- (c) Operating state by axis
According to exercise from “Chapter 8.1.2 Current State Reading,” it is a signal of “Operating” for each axis. It turns on when it is operating. Operating Data Setting can not be configured while it is running hence configuration will only be configured when it is not running. If you execute Synchronous Start by Position while it is running, the “error 341” would be appeared.
- (d) Error state for each axis
According to exercise from “Chapter 8.1.2 Current State Reading,” it is a signal of “Error state” for each axis. It turns on when an error occurred. Operation will only work when there is no error. If you want to operate a system regardless of errors, you can just inactivate the function.
- (e) Servo On signal
When applying the example program of “8.2.2 Current State Read”, this is “Servo On” signal for each axis. When each axis is Servo On state, it will be on. Since “Position synchronization” command can’t be executed when the axis is not servo on, it makes command executed when servo driver is “Servo On” state. If you execute “Position synchronization” command when axis is not Servo On state, the error 212 occurs.
- (f) Address of Positioning Module
In this example, Positioning Module is installed at the 3 slot of 0 bases.
- (g) Axis of command execution
You can set an axis for Parameter Setting. XBF-PN04(8)B supports for 4(8) axes. In the “execution of axis” from the configuration of Parameter Setting, you can set a value for axis1 through axis4.
- (h) Step of Subordinate Axis
Set step number for Subordinate Axis to execute a Speed Synchronization.

(i) Main Axis Setting

Set a main axis to operate Speed Synchronization. This setting is for main axis of Speed Synchronization. This setting cannot be set as same value as Axis of command execution, and possible setting values are as below.

(j) Value of Main Axis

Set value for Main Axis to execute Synchronous Start by Position. Therefore main axis will be executed the command when the subordinate axis reaches this set value.

Set value	Main Axis
1	Axis1
2	Axis2
3	Axis3
4	Axis4
5	Axis5
6	Axis6
7	Axis7
8	Axis8
9	Encoder1

(k) State of Operation complete

If function block is completed without error, "1" will be outputted and maintain "1" until the next operation. If error occurred, "0" will be outputted.

(l) Error State

This is the area that output error no. if there are errors in operation of function block.

(m) For more information, reference for Synchronous Start by Position is in the "Chapter 9.4.2."

(10) CAM Operation

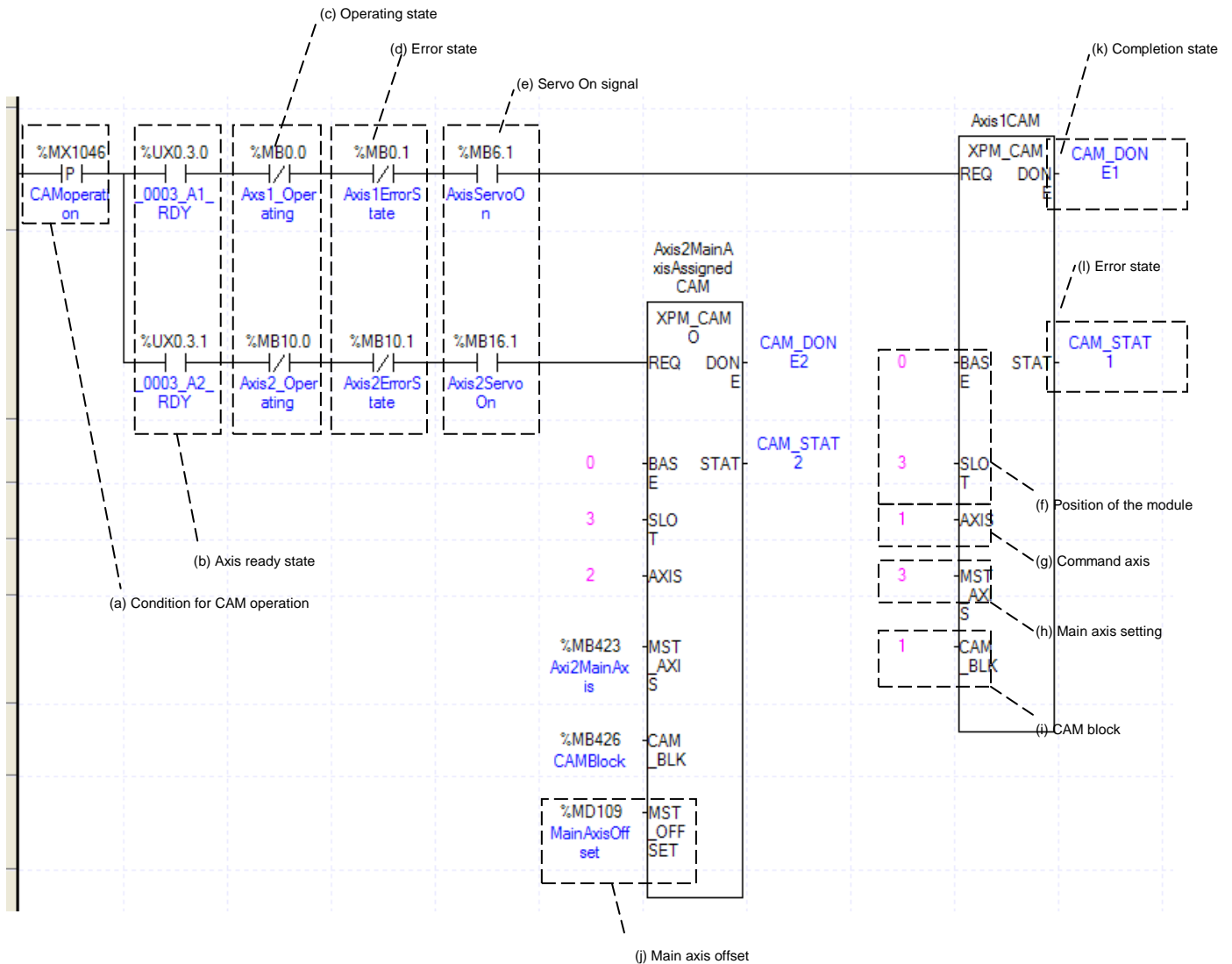

- (a) This is the condition for CAM Operation
This is the condition for CAM Operation Command (XPM_CAM)
- (b) Axis ready
If communication between the positioning module and the servo driver is normal, corresponding signal will be on.
- (c) Operating state by axis
According to exercise from “Chapter 8.1.2 Current State Reading,” it is a signal of “Operating” for each axis. It turns on when it is operating. Operating Data Setting can not be configured while it is running hence configuration will only be configured when it is not running. If you execute CAM Operation while it is running, the “error 701” would be appeared.
- (d) Error state for each axis
According to exercise from “Chapter 8.1.2 Current State Reading,” it is a signal of “Error state” for each axis. It turns on when an error occurred. Operation will only work when there is no error. If you want to operate a system regardless of errors, you can just inactivate the function.
- (e) Ready signal for each axis
According to exercise from “Chapter 8.1.2 Current State Reading,” it is a signal of “Drive Ready” for each axis. This command only works when this is the condition for Drive Ready is on. If a Drive Ready of main axis is not set as “ON,” the “error 703” would be appeared.

(f) Address of Positioning Module

In this example, Positioning Module is installed at the 3 slot of 0 bases.

(g) Axis of command execution

You can set an axis for Parameter Setting. XBF-PN04(8)B supports for 4(8) axes. In the “execution of axis” from the configuration of Parameter Setting, you can set a value for axis1 through axis4(8).

(h) Main Axis Setting

Setting of main axis to operate .This setting is for main axis of CAM Operating. This setting cannot be set as same value as Axis of command execution. Can set a value 1~4(8), meaning from axis1 to axis 4(8) and 9 meaning from encoder1.

(i) CAM Block Numbers

Set for Block Numbers of CAM data to operate CAM operation. XBF-PN04B/PN08B supports 8 CAM Blocks. The CAM Data for each Block would be downloaded to module written from Software Package.

(j) Main axis offset

In case of “XPM_CAMO”, you have to set the main axis offset position where sub axis starts CAM operation. After execution of instruction, sub axis starts CAM operation after main axis moves as far as the moving amount set at the main axis offset.

(k) State of Operation complete

If function block is completed without error, “1” will be outputted and maintain “1” until the next operation. If error occurred, “0” will be outputted.

(l) Error State

This is the area that output error no. if there are errors in operation of function block.

(m) For more information, reference of CAM Operation is in the “Chapter 9.4.3.”

(11) Deceleration Stop

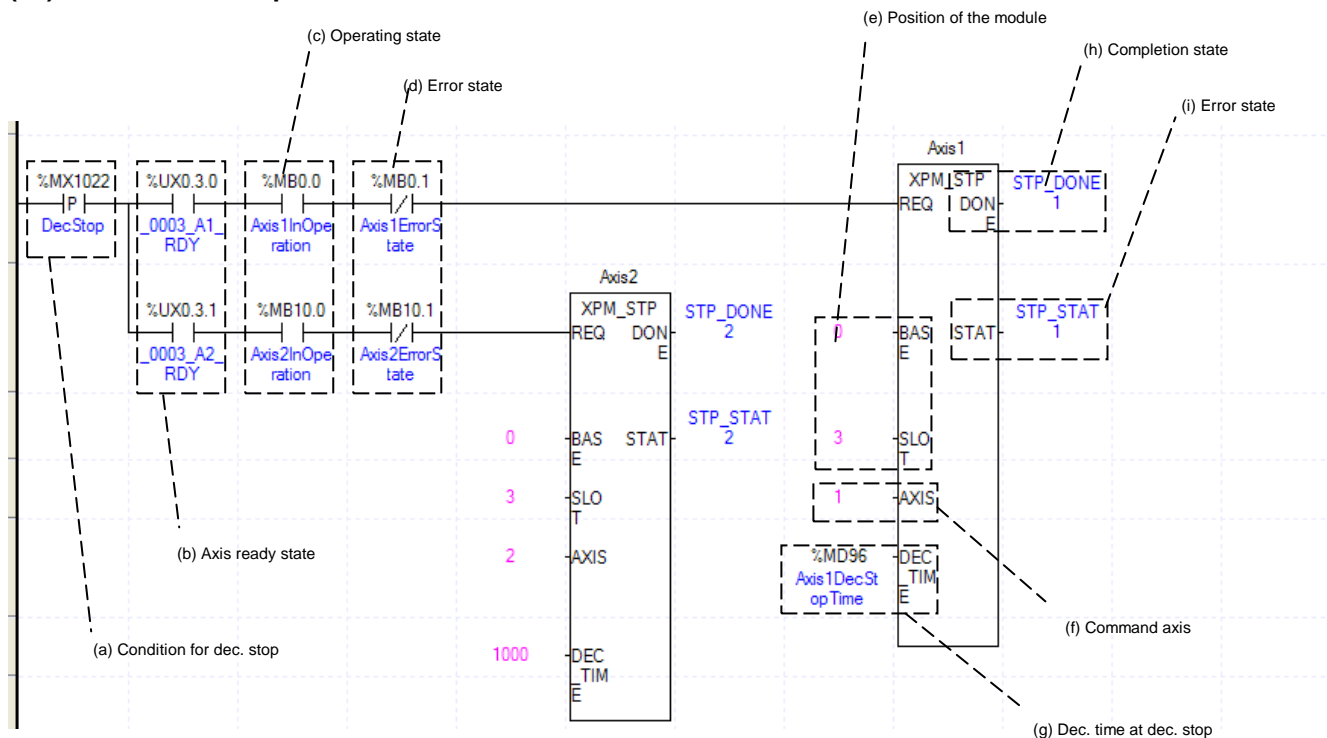

(a) This is the condition for Deceleration Stop

This is the condition for Deceleration Stop Command (XPM_STP)

(b) Axis ready

If communication between the positioning module and the servo driver is normal, corresponding signal will be on.

(c) Operating state by axis

According to exercise from “Chapter 8.2.2 Current State Reading,” it is a signal of “Operating” for each axis. It turns on when it is operating. Operating Data Setting can not be configured while it is running hence configuration will only be configured when it is not running.

- (d) Error state for each axis
According to exercise from “Chapter 8.2.2 Current State Reading,” it is a signal of “Error state” for each axis. It turns on when an error occurred. Operation will only work when there is no error. If you want to operate a system regardless of errors, you can just inactivate the function.
- (e) Address of Positioning Module
In this example, Positioning Module is installed at the 3 slot of 0 bases.
- (f) Axis of command execution
You can set an axis for Parameter Setting. XBF-PN04(8)B supports for 4(8) axes. In the “execution of axis” from the configuration of Parameter Setting, you can set a value for axis1 through axis4(8).
- (g) Deceleration time of Deceleration Stop
Set a deceleration time of Deceleration Stop operation. Unit of Deceleration Stop is [ms]. Since this time refers deceleration time from the speed limit, there might be little difference between Deceleration Stop set time and actual stop time. The range of deceleration time is “0~2,147,483,674.” 1~2,147,483,674 means Deceleration Time set as 1ms ~ 2,147483674ms. If it set as “0,” it will be operated with set deceleration value. Also it use to stop Speed Synchronous Operation or CAM Operation while Speed and CAM Operation. If Dec. stop command is executed at this time, Speed synchronization or CAM Operation is cancelled, it stops with Dec. time
- (h) State of Operation complete
If function block is completed without error, “1” will be outputted and maintain “1” until the next operation. If error occurred, “0” will be outputted.
- (i) Error State
This is the area that output error no. if there are errors in operation of function block.
- (j) For more information, reference of Deceleration Stop is in the “Chapter 9.2.18.”
- (k) Operation of each function block is as follows.
Axis1 Dec. Time : When axis1 is in operation, decelerate to %MD96(axis1 Dec. stop Time), then stop.
Axis2 Dec. Time : When axis 2 is in operation, decelerate to 1000ms, then stop.

(12) Emergency Stop

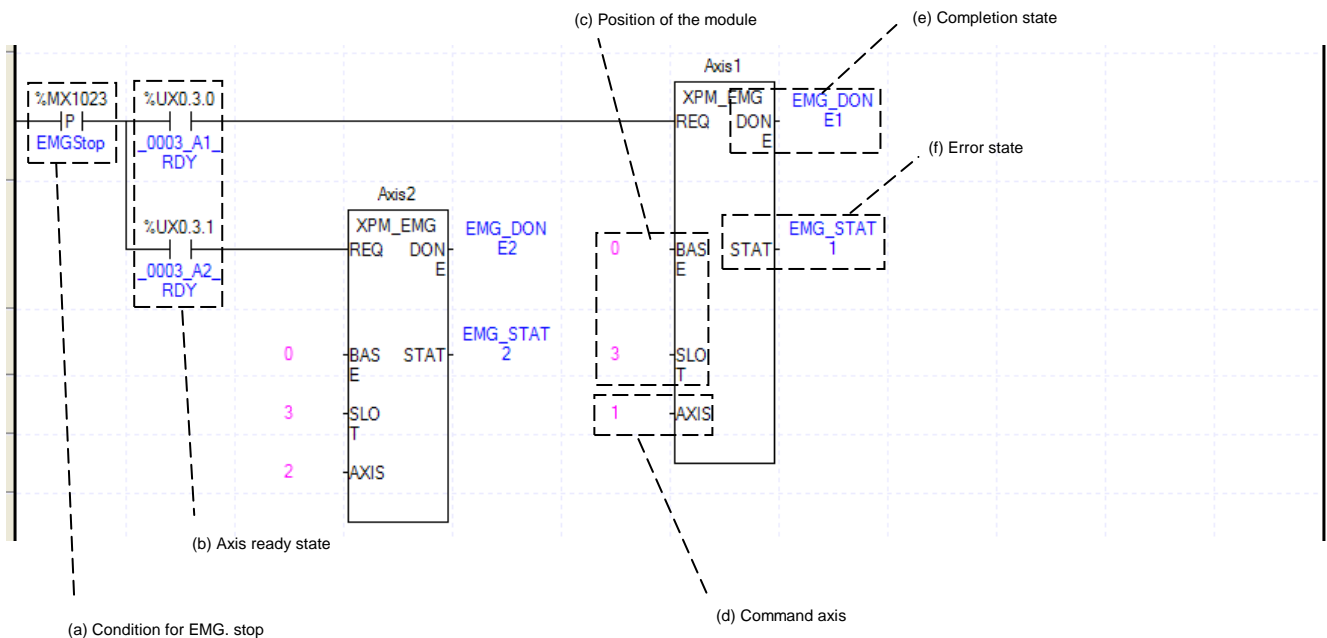

- (a) This is the condition for Emergency Stop
This is the condition for Emergency Stop Command (XPM_EMG)
- (b) Axis ready
If communication between the positioning module and the servo driver is normal, corresponding signal will be on.

- (c) Address of Positioning Module
In this example, Positioning Module is installed at the 3 slot of 0 bases.
- (d) Axis of command execution
You can set an axis for Emg. stop. XBF-PN04(8)B supports for 4(8) axes. In the “execution of axis” from the configuration of Parameter Setting, you can set a value for axis1 through axis4(8).
- (e) State of Operation complete
If function block is completed without error, “1” will be outputted and maintain “1” until the next operation. If error occurred, “0” will be outputted.
- (f) Error State
This is the area that output error no. if there are errors in operation of function block.
- (g) Emergency Stop is operating by each axis.
Once Emergency Stop command executes the error “481” would be occurred. With the set value for deceleration time, it will be decelerated and stop the operation
- (h) For more information, reference of Emergency Stop is in the “Chapter 9.2.18.”

(13) M code Cancellation

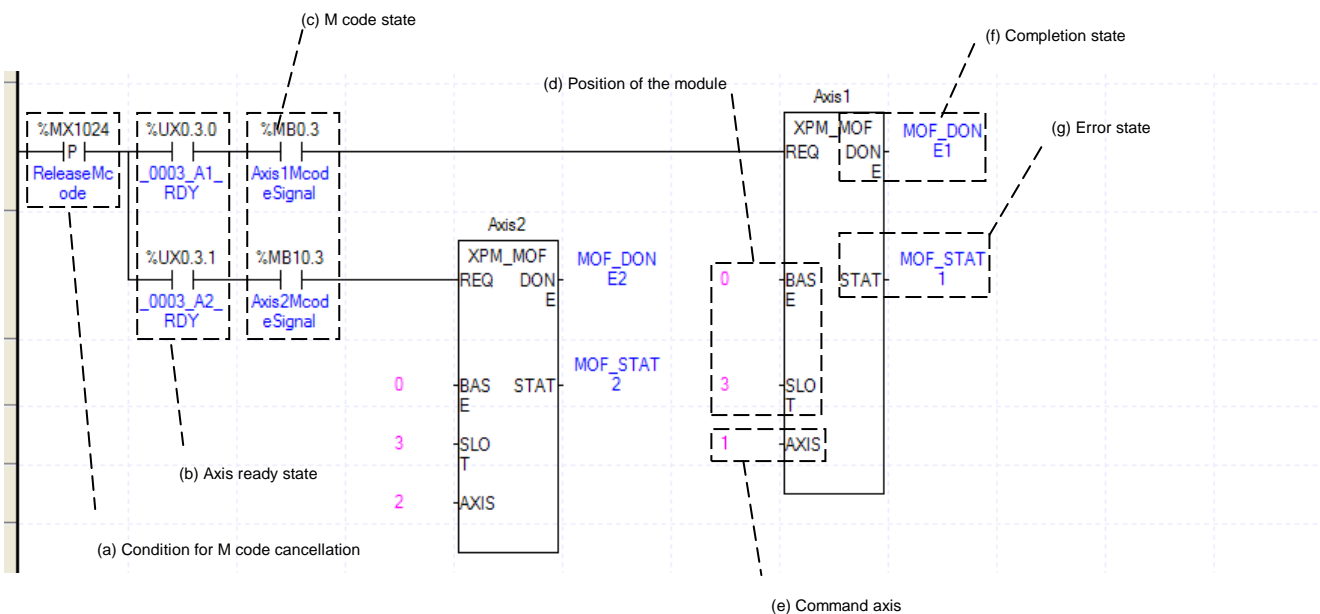

- (a) This is the condition for M code Cancellation
This is the condition for M code Cancellation (XPM_MOF). Once M code Cancellation command executed, number of M code would be change to “0,” and signal of M code to “Off.”
- (b) Axis ready
If communication between the positioning module and the servo driver is normal, corresponding signal will be on.
- (c) M code state for each axis
According to exercise from “Chapter 8.2.2 Current State Reading,” it is a signal of “M Code” for each axis. It turns on when it is operating. M code Cancellation command can only be valid once M code are generated. The condition for execution is operation possible when it is “On.”
- (d) Address of Positioning Module
In this example, Positioning Module is installed at the 3 slot of 0 bases.
- (e) Axis of command execution
You can set an axis for M code cancellation. XBF-PN04(8)B supports for 4(8) axes. In the “execution of axis” from the configuration of Parameter Setting, you can set a value for axis1 through axis4(8).
- (f) State of Operation complete
If function block is completed without error, “1” will be outputted and maintain “1” until the next operation. If error occurred, “0” will be outputted.
- (g) Error State
This is the area that output error no. if there are errors in operation of function block.
- (h) For more information, reference of M code Cancellation is in the “Chapter 9.6.2.”

(14) Torque Control

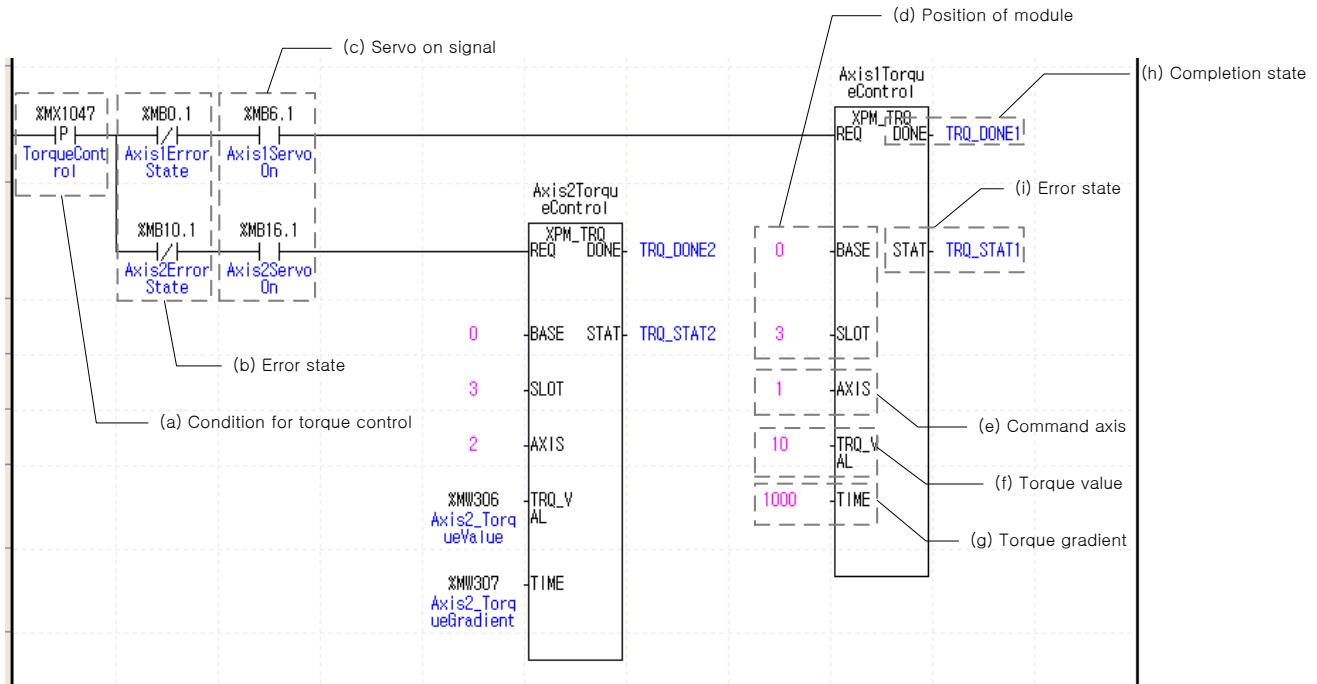

- (a) This is the condition for Torque Control
Conditions to execution the Control Torque command (XPM_TRQ). Once Torque Control command executed, the corresponding axis executions Control Torque with the set torque value and torque gradient.
- (b) Error state for each axis
According to exercise from “Chapter 8.2.2 Current State Reading,” it is a signal of “Error state” for each axis. It turns on when an error occurred. Operation will only work when there is no error. If you want to operate a system regardless of errors, you can just inactivate the function.
- (c) Servo on signal for each axis
According to exercise from “Chapter 8.1.2 Current State Reading,” it is a signal of “Servo On” for each axis. This command only works when this is the condition for Servo is on. If the Control Torque command is executed when it is not the state of servo on, No. 743 error takes place.
- (d) Address of Positioning Module
In this example, Positioning Module is installed at the 3 slot of 0 bases.
- (e) Axis of command execution
You can set an axis for M code cancellation. XBF-PN04(8)B supports for 4(8) axes. In the “execution of axis” from the configuration of Parameter Setting, you can set a value for axis1 through axis4(8).
- (f) After executing the Control Torque command, set torque value to drive under the Torque Control command. The torque value range is -32768 through 32767%.
- (g) Set gradient until the target torque in time. The gradient range is 0 through 65535ms.
- (h) State of Operation complete
If function block is completed without error, “1” will be outputted and maintain “1” until the next operation. If error occurred, “0” will be outputted.
- (i) Error State
This is the area that output error no. if there are errors in operation of function block.
- (j) For more information, reference of Torque Control is in the “Chapter 9.2.21 Torque Control.”

8.2.7 Operation Setting Change while Operating

(1) Speed Override

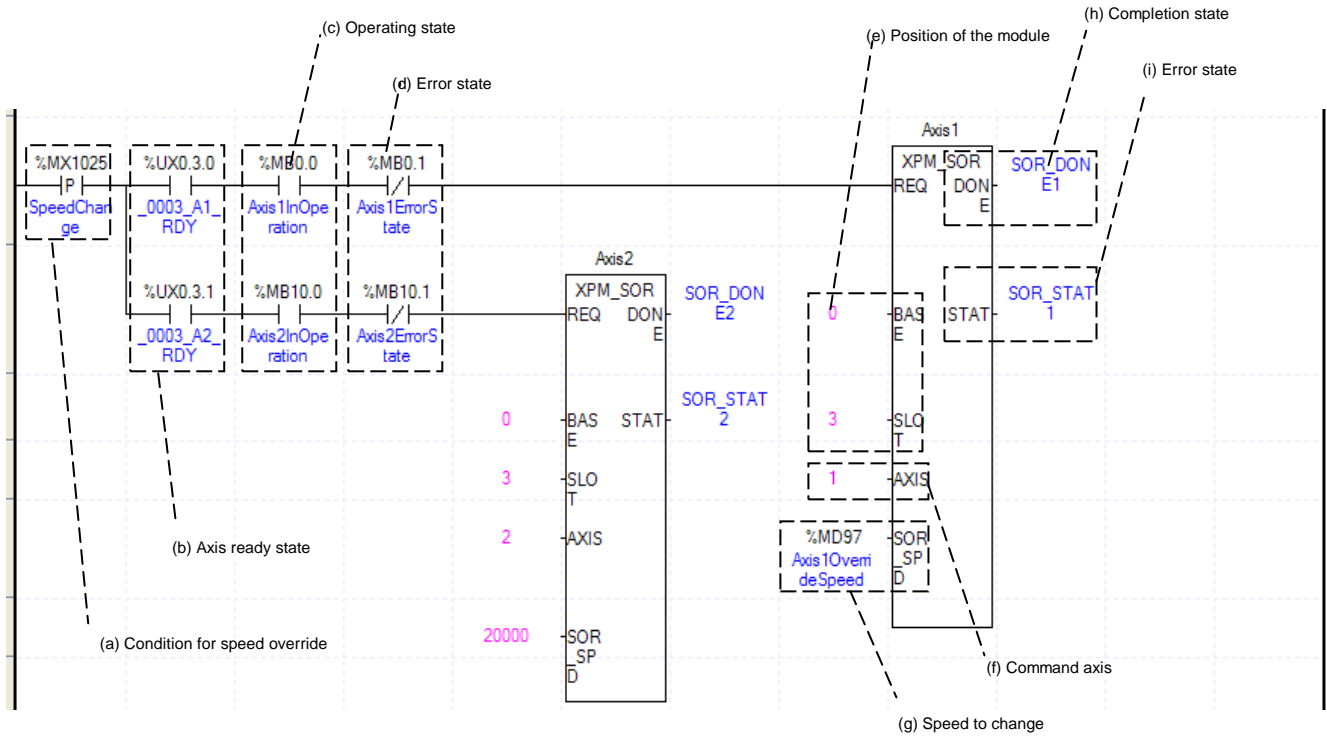

(a) This is the condition for Speed Override

This is the condition for Speed Override Command (XPM_SOR)

(b) Axis ready

If communication between the positioning module and the servo driver is normal, corresponding signal will be on.

(c) Operating state by axis

According to exercise from “Chapter 8.2.2 Current State Reading,” it is a signal of “Operating” for each axis. It turns on when it is operating. Operating Data Setting can not be configured while it is running hence configuration will only be configured when it is not running. If you execute Speed Override while it is running, the “error 371” would be appeared.

(d) Error state for each axis

According to exercise from “Chapter 8.2.2 Current State Reading,” it is a signal of “Error state” for each axis. It turns on when an error occurred. Operation will only work when there is no error. If you want to operate a system regardless of errors, you can just inactivate the function.

(e) Address of Positioning Module

In this example, Positioning Module is installed at the 3 slot of 0 bases.

(f) Axis of command execution

You can set an axis for Speed override. XBF-PN04(8)B supports for 4(8) axes. In the “execution of axis” from the configuration of Parameter Setting, you can set a value for axis1 through axis 4(8).

(g) Value Change for Speed Operation

Set speed value. According to Speed Override from common parameters, it is a signal of “%” or “Speed Value” depends on setting of category. Also, when Speed Override set as Speed Value, it means Unit/Time depends on Speed Command Unit from basic parameters, or it means “rpm.” If a changing Operation Speed Value is “%,” then the unit would be $[X10^{-2}\%]$. If it is “rpm,” then the unit would be $X10^{-1}$ rpm].

(h) State of Operation complete

If function block is completed without error, “1” will be outputted and maintain “1” until the next operation. If error occurred, “0” will be outputted.

(i) Error State

This is the area that output error no. if there are errors in operation of function block.

(j) The function block in the example above is as follows.

Axis1 Speed Override : The operating speed of axis1 will be changed to speed value saved in %MD97 and then continue to operate.

Axis2 Speed Override : The operating speed of axis2 will be changed to 20000 and then continue to operate.

(k) For more information, reference of Speed Override is in the “Chapter 9.5.5.”

(2) Position Override

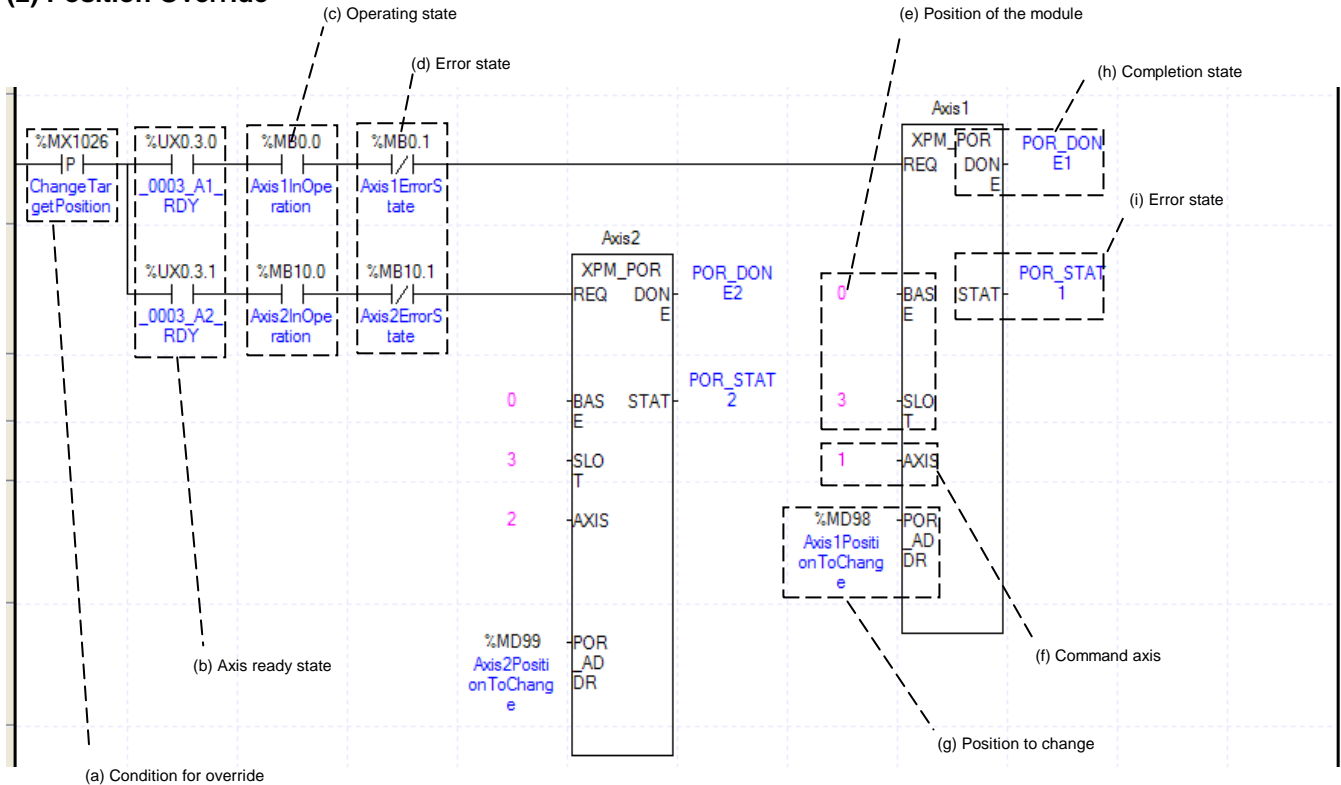

(a) This is the condition for Position Override

This is the condition for Position Override Command (XPM_POR)

(b) Axis ready

If communication between the positioning module and the servo driver is normal, corresponding signal will be on.

(c) Operating state by axis

According to exercise from “Chapter 8.2.2 Current State Reading,” it is a signal of “Operating” for each axis. It turns on when it is operating. Operating Data Setting can not be configured while it is running hence configuration will only be configured when it is not running. If you execute Position Override while it is running, the “error 361” would be appeared.

(d) Error state for each axis

According to exercise from “Chapter 8.2.2 Current State Reading,” it is a signal of “Error state” for each axis. It turns on when an error occurred. Operation will only work when there is no error. If you want to operate a system regardless of errors, you can just inactivate the function.

(e) Address of Positioning Module

In this example, Positioning Module is installed at the 3 slot of 0 bases.

(f) Axis of command execution

You can set an axis for Position override. XBF-PN04(8)B supports for 4(8) axes. In the “execution of axis” from the configuration of Parameter Setting, you can set a value for axis1 through axis4(8).

(g) Change for Goal Position Value

Setting Value Change for Goal Position Value. The unit of this value depends on “Unit” category. Once Position Override commands are executed, the goal position of executed axis will be changed to set goal position.

- (h) State of Operation complete
If function block is completed without error, “1” will be outputted and maintain “1” until the next operation. If error occurred, “0” will be outputted.
- (i) Error State
This is the area that output error no. if there are errors in operation of function block.
- (j) The function block in the example above is as follows.
Axis1 Position Override: Goal position of axis1 is changed to the value saved in %MD98.
Axis2 Position Override: Goal position of axis2 is changed to the value saved in %MD99.
- (k) For more information, reference of Position Override is in the “Chapter 9.5.4.”

(3) Position Assign Speed Override

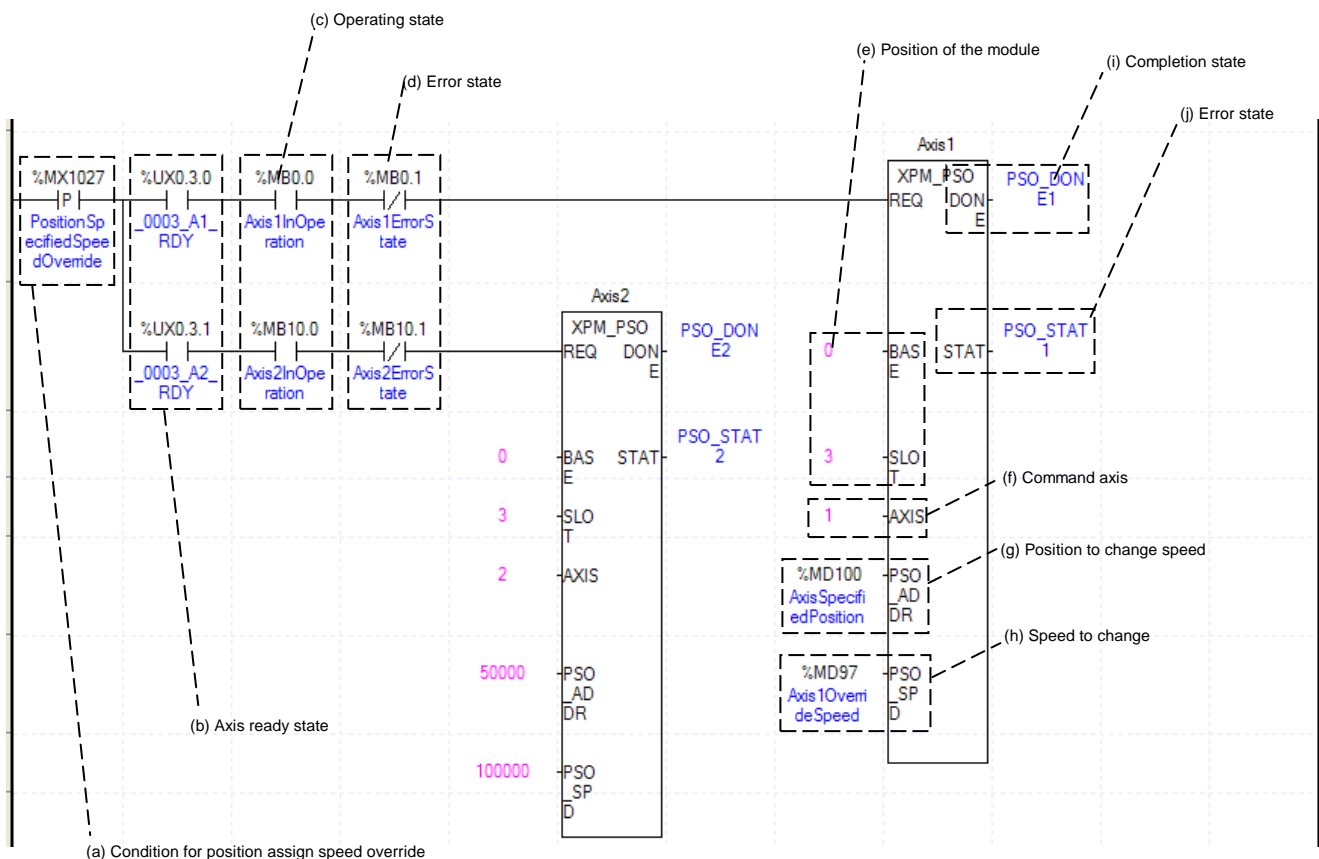

- (a) This is the condition for Position Assign Speed Override
This is the condition for Position Assign Speed Override Command (XPM_PSO)
- (b) Axis ready
If communication between the positioning module and the servo driver is normal, corresponding signal will be on.
- (c) Operating state by axis
According to exercise from “Chapter 8.2.2 Current State Reading,” it is a signal of “Operating” for each axis. It turns on when it is operating. Operating Data Setting can not be configured while it is running hence configuration will only be configured when it is not running. If you execute Position Assign Speed Override while it is running, the “error 381” would be appeared.
- (d) Error state for each axis
According to exercise from “Chapter 8.2.2 Current State Reading,” it is a signal of “Error state” for each axis. It turns on when an error occurred. Operation will only work when there is no error. If you want to operate a system regardless of errors, you can just inactivate the function.
- (e) Address of Positioning Module
In this example, Positioning Module is installed at the 3 slot of 0 bases.
- (f) Axis of command execution
You can set an axis for Position assign speed override. XBF-PN04(8)B supports for 4(8) axes. In the

“execution of axis” from the configuration of Parameter Setting, you can set a value for axis1 through axis4(8).

- (g) Position of Speed Change Execution
Set the position of Speed Change. Once the actual position located at set position with speed override command running, the speed change commands are executed.
- (h) Value Change for Operation speed
Set the Value Change for Operation speed. According to Speed Override from common parameters, it is a signal of “%” or “Speed Value” depends on setting of category. Also, when Speed Override set as Speed Value, it means Unit/Time depends on Speed Command Unit from basic parameters, or it means “rpm.” If a changing Operation Speed Value is “%,” then the unit would be $[X10^{-2}\%]$. If it is “rpm,” then the unit would be $X10^{-1}$ rpm].
- (i) State of Operation complete
If function block is completed without error, “1” will be outputted and maintain “1” until the next operation. If error occurred, “0” will be outputted.
- (j) Error State
This is the area that output error no. if there are errors in operation of function block.
- (k) The function block in the example above is as follows.
Axis1 Positioning Speed Override : When the current position of axis1 become the same position as the position saved in %MD100, the speed value will be changed to the speed saved in %MD92.
Axis2 Positioning Speed Override : When the current position of axis1 become 50000, the speed will be changed to 100000.
- (l) For more information, reference of Position Assign Speed Override is in the “Chapter 9.5.6.”

(4) Speed/Position Switching Control

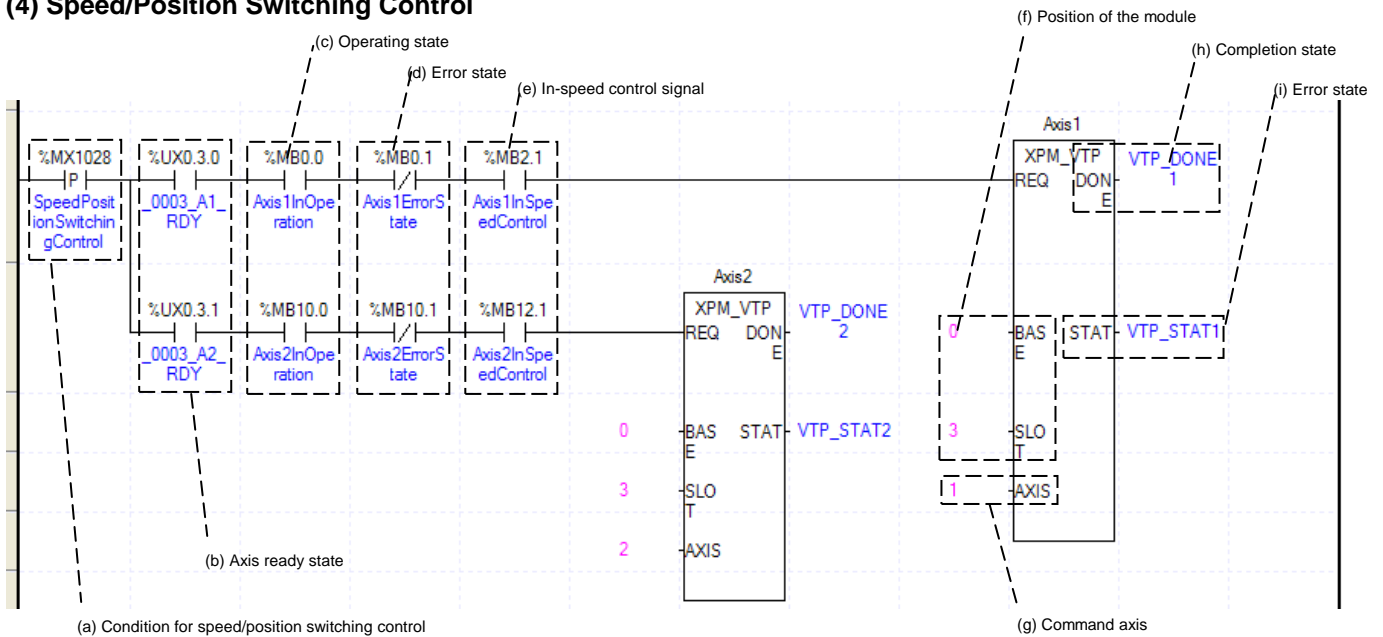

- (a) This is the condition for Speed/Position Switching Control
This is the condition for Speed/Position Switching Control Command (XPM_VTP)
- (b) Axis ready
If communication between the positioning module and the servo driver is normal, corresponding signal will be on.
- (c) Operating state by axis
According to exercise from “Chapter 8.2.2 Current State Reading,” it is a signal of “Operating” for each axis. It turns on when it is operating. Operating Data Setting can not be configured while it is running hence configuration will only be configured when it is not running. If you execute Speed/Position Switching Control while it is running, the “error 301” would be appeared.

- (d) Error state for each axis
According to exercise from “Chapter 8.2.2 Current State Reading,” it is a signal of “Error state” for each axis. It turns on when an error occurred. Operation will only work when there is no error. If you want to operate a system regardless of errors, you can just inactivate the function.
- (e) Signal from Speed Control by each Axis
According to exercise from “Chapter 8.2.2 Current State Reading,” it is a signal of “Speed Control state” for each axis. It turns on when it is operating. Speed/Position Switching Control Setting can only be configured while it is running. If you execute Speed/Position Switching Control while it is not running, the “error 302” would be appeared.
- (f) Address of Positioning Module
In this example, Positioning Module is installed at the 3 slot of 0 bases.
- (g) Axis of command execution
You can set an axis for Parameter Setting. XBF-PN04(8)B supports for 4(8) axes. In the “execution of axis” from the configuration of Parameter Setting, you can set a value for axis1 through axis4(8).
- (h) State of Operation complete
If function block is completed without error, “1” will be outputted and maintain “1” until the next operation. If error occurred, “0” will be outputted.
- (i) Error State
This is the area that output error no. if there are errors in operation of function block.
- (j) For more information, reference of Speed/Position Switching Control is in the “Chapter 9.2.14.”

(5) Position Specified Speed/Position Switching Control

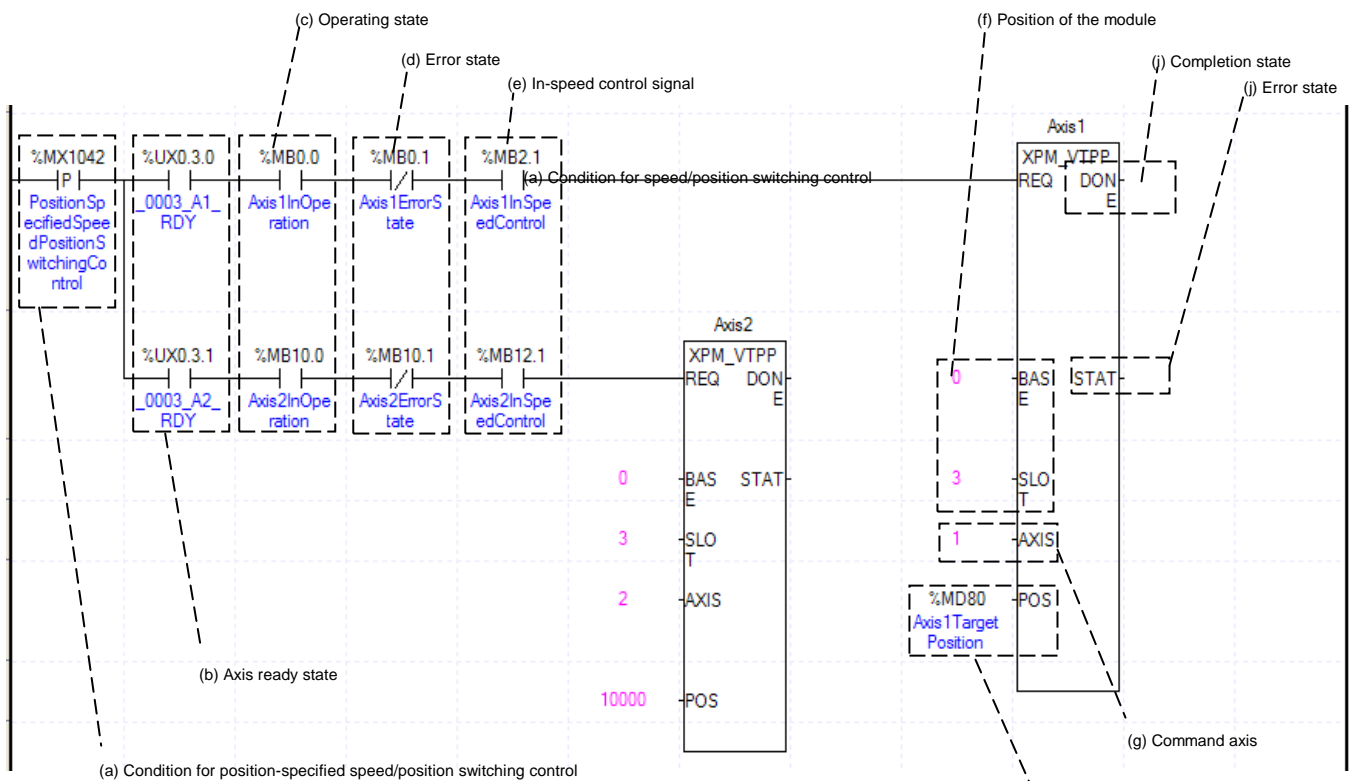

- (a) Condition to perform “position-specified speed/position switching control”
Condition to perform control command (XPM_VTPP) for position-specified speed/position switching
- (b) Axis ready
If communication between the positioning module and the servo driver is normal, corresponding signal will be on.

- (c) Operation state for each axis
 In case that an example program of“8.1.2 Read Current State” is applied, it is a signal showing that each axis is “operating.” If a relevant axis is running, it becomes ‘On’. A condition has been set to make the control command for position specified speed/position switching valid only when the relevant axis is running. If the control command for position specified switching is carried out when the relevant axis is not running, No.301 Error will take place.
- (d) Error State for each axis
 In case that an example program of“8.1.2 Read Current State” is applied, it is a signal showing “Error State” for each axis. If any error takes place, it becomes ‘On’. A condition has been set to perform a control command only when there is no error with the relevant axis. If the user wants to execute a command regardless of the occurrence of errors, he/she may remove this condition.
- (e) Speed Control Signal for each axis
 In case that an example program of“8.1.2 Read Current State” is applied, it is a signal showing each axis is “controlling its speed.” If the relevant axis is running under speed control, it becomes ‘On.’ A condition has been set to make the control command for position specified speed/position switching control valid only when the relevant axis is in a speed control status. If the control command is carried out when the relevant axis is not in a speed control status, No.302 Error will take place.
- (f) Position of a module
 For the example program above, it is assumed that positioning modules are installed on NO.0 Base and No. 3 Slot.
- (g) Axis to make a command
 Decide an axis that will execute the control command. XBF-PN04(8)B can control up to four axes and assign 1 through 4(8) referring to 1-axis through 4(8)-axis for this item.
- (h) Transfer amount
 After the control command for position specified speed/position control switching is executed, convert from speed control to position control and moves by transfer amount.
- (i) Completion state
 If any function block is completely executed without any error, it displays and maintains “1” until the next execution while it displays“0” if any error takes place.
- (j) Error state
 If any error takes place when any function block is executed, this area generates its error number.
- (k) For details on the operation of position specified speed/position switching control, refer to “position specified speed/position switching control”

(6) Position/ Speed Switching Control

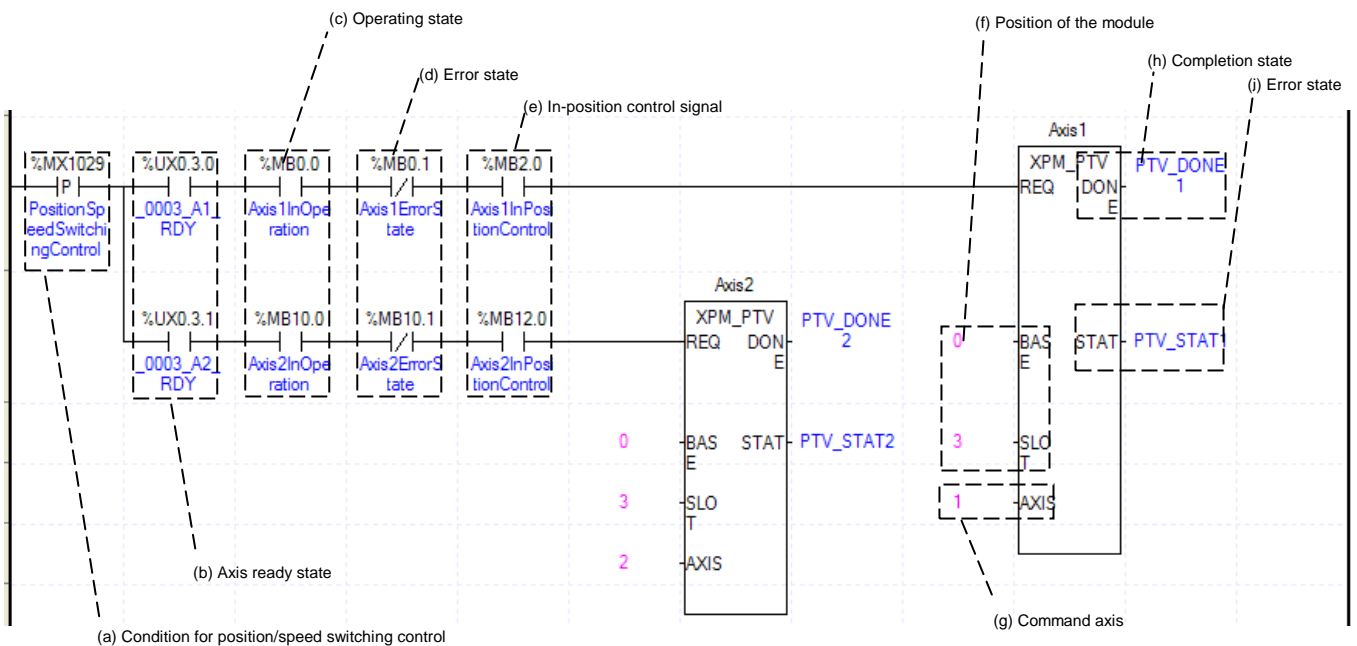

- (a) This is the condition for Position/ Speed Switching Control
This is the condition for Position/ Speed Switching Control Command (XPM_PTV)
- (b) Axis ready
If communication between the positioning module and the servo driver is normal, corresponding signal will be on.
- (c) Operating state by axis
According to exercise from “Chapter 8.2.2 Current State Reading,” it is a signal of “Operating” for each axis. It turns on when it is operating. Operating Data Setting can not be configured while it is running hence configuration will only be configured when it is not running. If you execute Position/ Speed Switching Control while it is running, the “error 311” would be appeared.
- (d) Error state for each axis
According to exercise from “Chapter 8.2.2 Current State Reading,” it is a signal of “Error state” for each axis. It turns on when an error occurred. Operation will only work when there is no error. If you want to operate a system regardless of errors, you can just inactivate the function.
- (e) Signal from Position Control by each Axis
According to exercise from “Chapter 8.2.2 Current State Reading,” it is a signal of “Position Control state” for each axis. It turns on when it is operating. Position/ Speed Switching Control Setting can only be configured while it is running. If you execute Position/Speed Switching Control while it is not running, the “error 317” would be appeared.
- (f) Address of Positioning Module
In this example, Positioning Module is installed at the 3 slot of 0 bases.
- (g) Axis of command execution
You can set an axis for Parameter Setting. XBF-PN04(8)B supports for 4(8) axes. In the “execution of axis” from the configuration of Parameter Setting, you can set a value for axis1 through axis4(8).
- (h) State of Operation complete
If function block is completed without error, “1” will be outputted and maintain “1” until the next operation. If error occurred, “0” will be outputted.
- (i) Error State
This is the area that output error no. if there are errors in operation of function block.
- (j) For more information, reference of Position/ Speed Switching Control is in the “Chapter 9.2.15.”

(7) Position/ Torque Switching Control

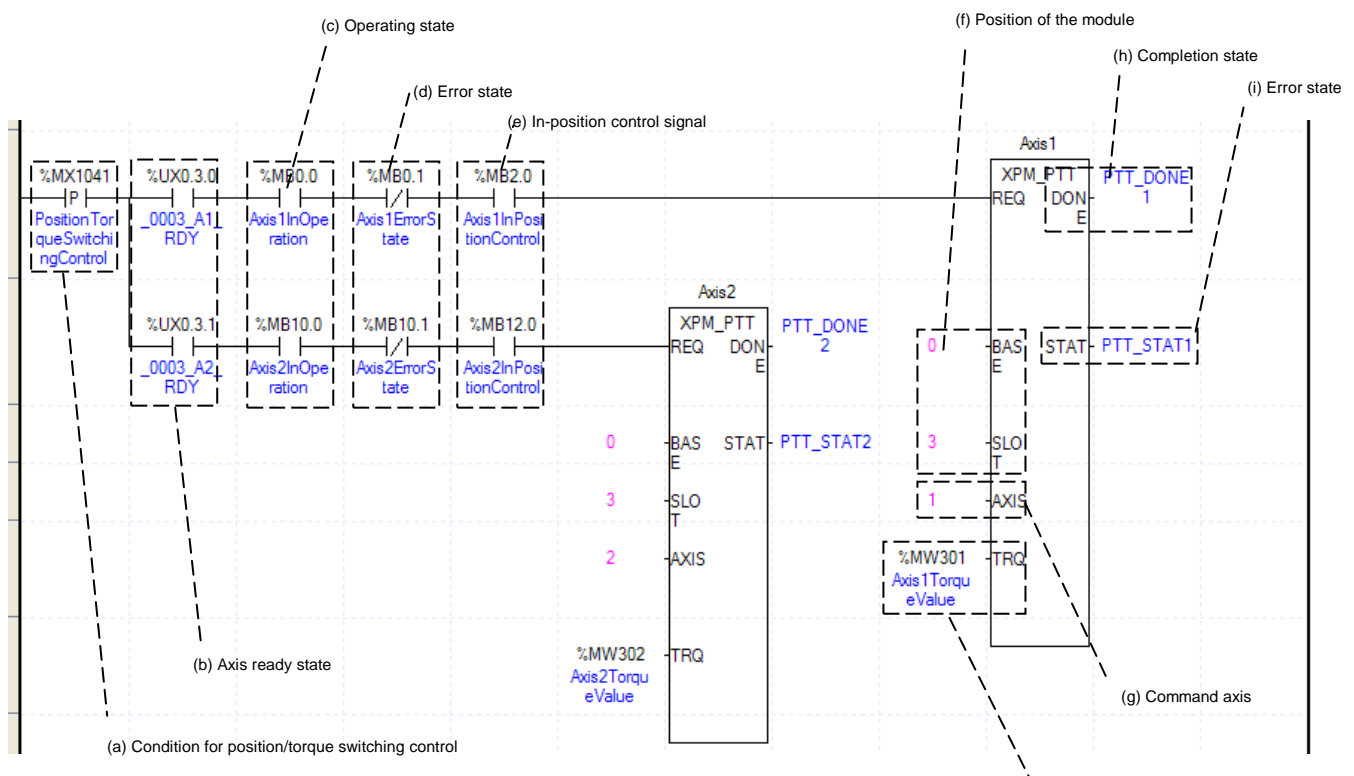

- (a) This is the condition for Position/ Torque Switching Control
This is the condition for Position/ Torque Switching Control Command (XPM_PTT) (i) Torque value to operate
- (b) Axis ready
If communication between the positioning module and the servo driver is normal, corresponding signal will be on.
- (c) Operating state by axis
According to exercise from “Chapter 8.2.2 Current State Reading,” it is a signal of “Operating” for each axis. It turns on when it is operating. Operating Data Setting can not be configured while it is running hence configuration will only be configured when it is not running. If you execute Position/ Torque Switching Control while it is running, the “error 561” would be appeared.
- (d) Error state for each axis
According to exercise from “Chapter 8.2.2 Current State Reading,” it is a signal of “Error state” for each axis. It turns on when an error occurred. Operation will only work when there is no error. If you want to operate a system regardless of errors, you can just inactivate the function.
- (e) Signal from Position Control by each Axis
According to exercise from “Chapter 8.2.2 Current State Reading,” it is a signal of “Position Control state” for each axis. It turns on when it is operating. Position/ Torque Switching Control Setting can only be configured while it is running. If you execute Position/Torque Switching Control while it is not running, the error would be appeared according to control type
- (f) Address of Positioning Module
In this example, Positioning Module is installed at the 3 slot of 0 bases.
- (g) Axis of command execution
You can set an axis for Parameter Setting. XBF-PN04(8)B supports for 4(8) axes. In the “execution of axis” from the configuration of Parameter Setting, you can set a value for axis1 through axis4(8).
- (h) State of Operation complete
If function block is completed without error, “1” will be outputted and maintain “1” until the next operation. If error occurred, “0” will be outputted.
- (i) Error State
This is the area that output error no. if there are errors in operation of function block.
- (j) Torque value to operate
This is the area that sets torque value to be used after switching
- (k) For more information, reference of Position/ Speed Switching Control is in the “Chapter 9.2.17.”

(8) Skip Operation

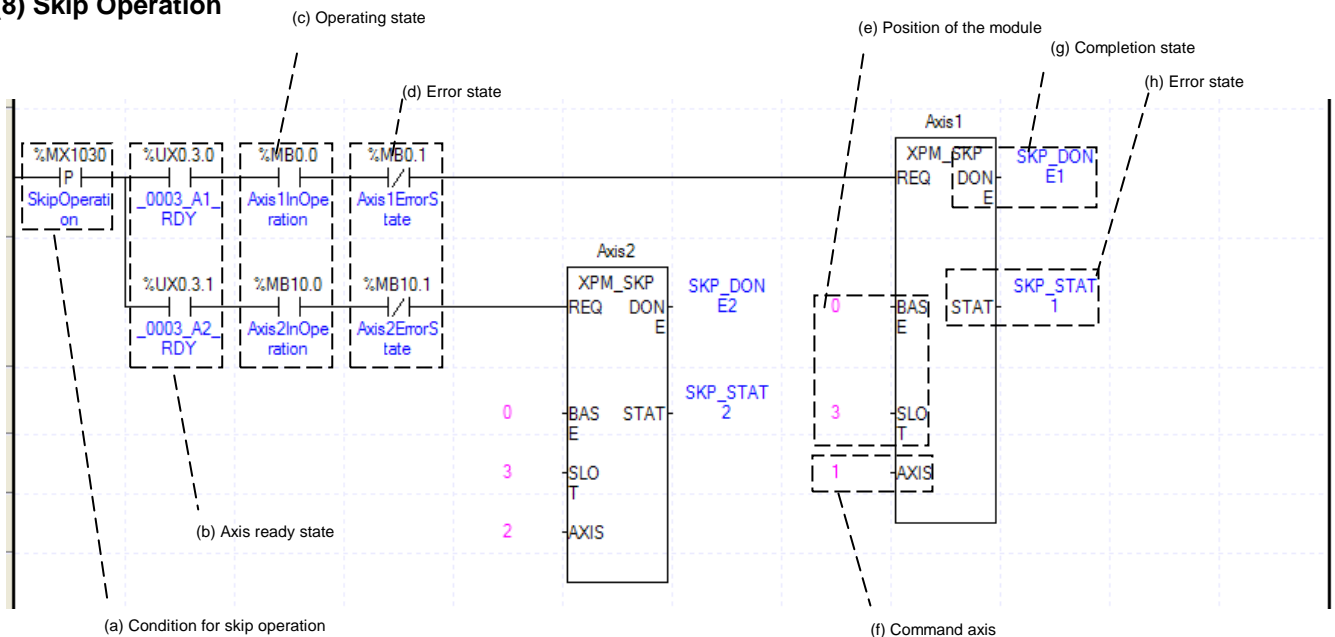

- (a) This is the condition for Skip Operation
This is the condition for Skip Operation Command (XPM_SKP) Once Skip Operation is executed, current operation step is stop and will go to operate with next step.
- (b) Axis ready
If communication between the positioning module and the servo driver is normal, corresponding signal will be on.
- (c) Operating state by axis
According to exercise from "Chapter 8.2.2 Current State Reading," it is a signal of "Operating" for each axis. It turns on when it is operating. Operating Data Setting can not be configured while it is running hence configuration will only be configured when it is not running. If you execute Skip Operation while it is running, the "error 331" would be appeared.
- (d) Error state for each axis
According to exercise from "Chapter 8.2.2 Current State Reading," it is a signal of "Error state" for each axis. It turns on when an error occurred. Operation will only work when there is no error. If you want to operate a system regardless of errors, you can just inactivate the function.
- (e) Address of Positioning Module
In this example, Positioning Module is installed at the 3 slot of 0 bases.
- (f) Axis of command execution
You can set an axis for Parameter Setting. XBF-PN04(8)B series supports for 4(8) axes. In the "execution of axis" from the configuration of Parameter Setting, you can set a value for axis1 through axis4(8).
- (g) State of Operation complete
If function block is completed without error, "1" will be outputted and maintain "1" until the next operation. If error occurred, "0" will be outputted.
- (h) Error State
This is the area that output error no. if there are errors in operation of function block.
- (i) For more information, reference of Skip Operation is in the "Chapter 9.5.3."

(9) Continuous Operation

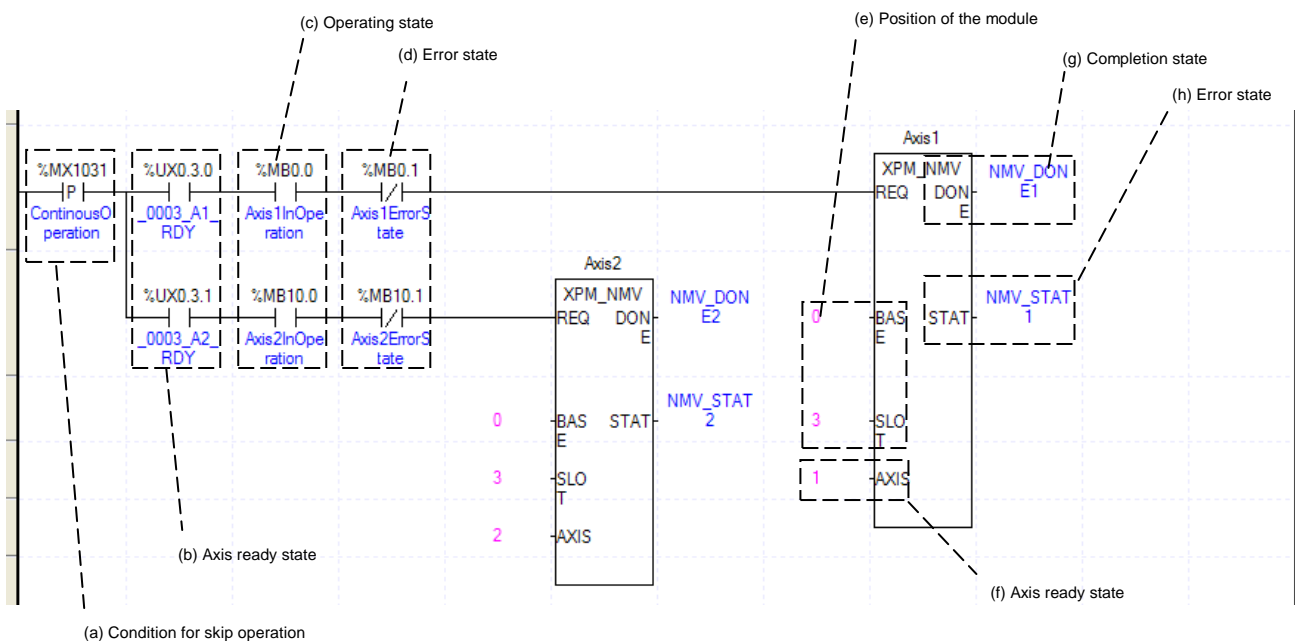

- (a) This is the condition for Continuous Operation
This is the condition for Continuous Operation Command (XPM_NMV). Once Continuous Operation is executed, current operation step and next operation step would be operated continuously.
- (b) Axis ready
If communication between the positioning module and the servo driver is normal, corresponding signal will be on.

(c) Operating state by axis

According to exercise from “Chapter 8.2.2 Current State Reading,” it is a signal of “Operating” for each axis. It turns on when it is operating. Operating Data Setting can not be configured while it is running hence configuration will only be configured when it is not running. If you execute Continuous Operation while it is running, the “error 391” would be appeared.

(d) Error state for each axis

According to exercise from “Chapter 8.2.2 Current State Reading,” it is a signal of “Error state” for each axis. It turns on when an error occurred. Operation will only work when there is no error. If you want to operate a system regardless of errors, you can just inactivate the function.

(e) Address of Positioning Module

In this example, Positioning Module is installed at the 3 slot of 0 bases.

(f) Axis of command execution

You can set an axis for Parameter Setting. XBF-PN04(8)B supports for 4(8) axes. In the “execution of axis” from the configuration of Parameter Setting, you can set a value for axis1 through axis4(8).

(g) State of Operation complete

If function block is completed without error, “1” will be outputted and maintain “1” until the next operation. If error occurred, “0” will be outputted.

(h) Error State

This is the area that output error no. if there are errors in operation of function block.

(i) For more information, reference of Continuous Operation is in the “Chapter 9.5.2.”

(10) Current Step Change (Start Step Number Change)

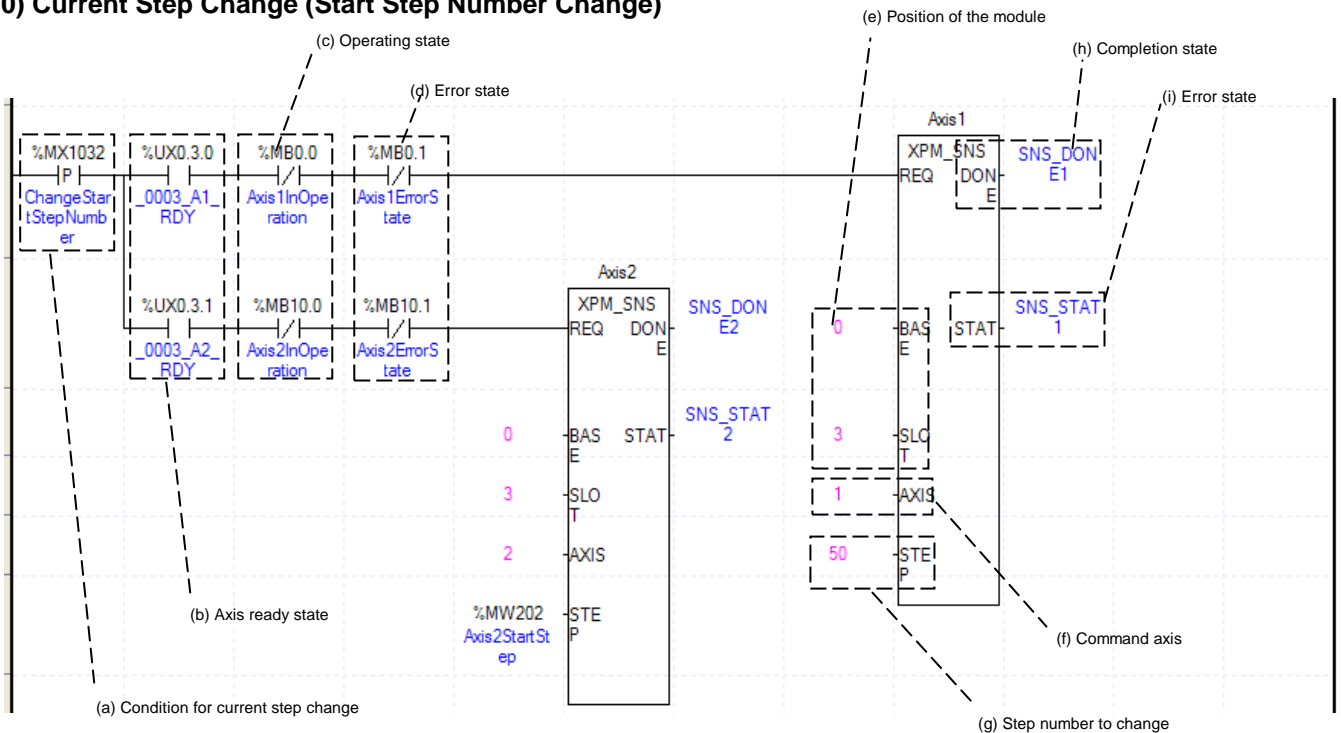

(a) This is the condition for Current Step Change

This is the condition for Current Step Change Command (XPM_SNS). Once Current Step Change is executed, current operation step will move set step.

(b) Axis ready

If communication between the positioning module and the servo driver is normal, corresponding signal will be on.

(c) Operating state by axis

According to exercise from “Chapter 8.2.2 Current State Reading,” it is a signal of “Operating” for each axis. It turns on when it is operating. Operating Data Setting can not be configured while it is running hence configuration will only be configured when it is not running. If you execute Current Step Change while it is

running, the “error 441” would be appeared.

- (d) Error state for each axis
According to exercise from “Chapter 8.2.2 Current State Reading,” it is a signal of “Error state” for each axis. It turns on when an error occurred. Operation will only work when there is no error. If you want to operate a system regardless of errors, you can just inactivate the function.
- (e) Address of Positioning Module
In this example, Positioning Module is installed at the 3 slot of 0 bases.
- (f) Axis of command execution
You can set an axis for Parameter Setting. XBF-PN04(8)B supports for 4(8) axes. In the “execution of axis” from the configuration of Parameter Setting, you can set a value for axis1 through axis4(8).
- (g) Change Step Number
Set change step number by Current Step Change. XBF-PN04B/PN08B support 400 step operation data for each Axis. Therefore, the range of step number setting of Current Step Change is 1~400.
- (h) State of Operation complete
If function block is completed without error, “1” will be outputted and maintain “1” until the next operation. If error occurred, “0” will be outputted.
- (i) Error State
This is the area that output error no. if there are errors in operation of function block.
- (j) For more information, reference of Current Step Change is in the “Chapter 9.5.9.”

(11) Repeat Step No. Change

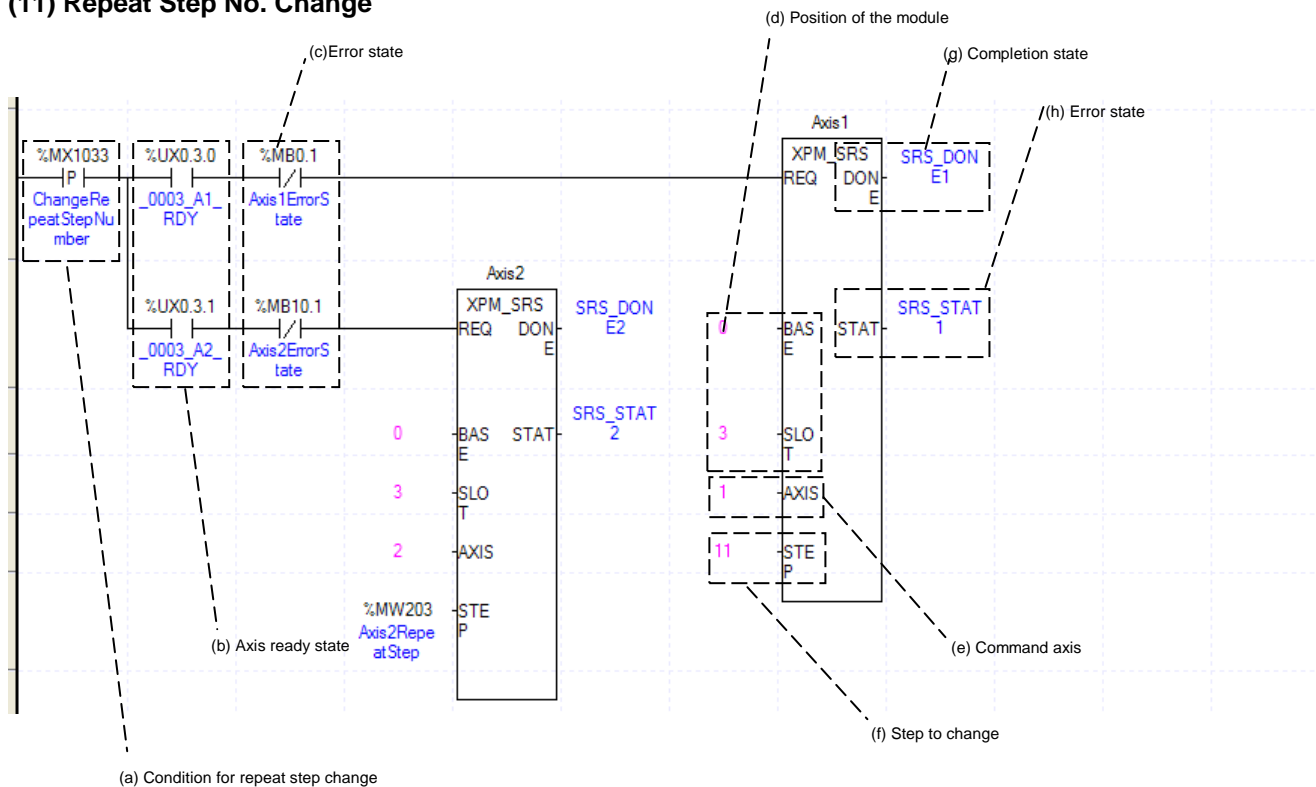

- (a) This is the condition for Repeat Step No. Change
This is the condition for Repeat Step No. Change Command (XSRS). Once Repeat Step No. Change is executed, current operation step will move set step. It will execute a operation when set of Operation Method is “Repeat.”
- (b) Axis ready
If communication between the positioning module and the servo driver is normal, corresponding signal will be on.

- (c) Error state for each axis
According to exercise from “Chapter 8.1.2 Current State Reading,” it is a signal of “Error state” for each axis. It turns on when an error occurred. Operation will only work when there is no error. If you want to operate a system regardless of errors, you can just inactivate the function.
- (d) Address of Positioning Module
In this example, Positioning Module is installed at the 3 slot of 0 bases.
- (e) Axis of command execution
You can set an axis for Parameter Setting. XBF-PN04(8)B supports for 4(8) axes. In the “execution of axis” from the configuration of Parameter Setting, you can set a value for axis1 through axis4(8).
- (f) Change Step Number
Set change step number by Current Step Change. XBF-PN04B/PN08B supports 400 step operation data for each Axis.
Therefore, the range of step number setting of Current Step Change is 1~400. In the example, Axis1 and axis2 are changed to step no.11 and step no. saved in %MW203.
- (g) State of Operation complete
If function block is completed without error, “1” will be outputted and maintain “1” until the next operation. If error occurred, “0” will be outputted.
- (h) Error State
This is the area that output error no. if there are errors in operation of function block.
- (i) For more information, reference of Repeat Step No. Change is in the “Chapter 9.5.10.”

(12) Current Position Preset

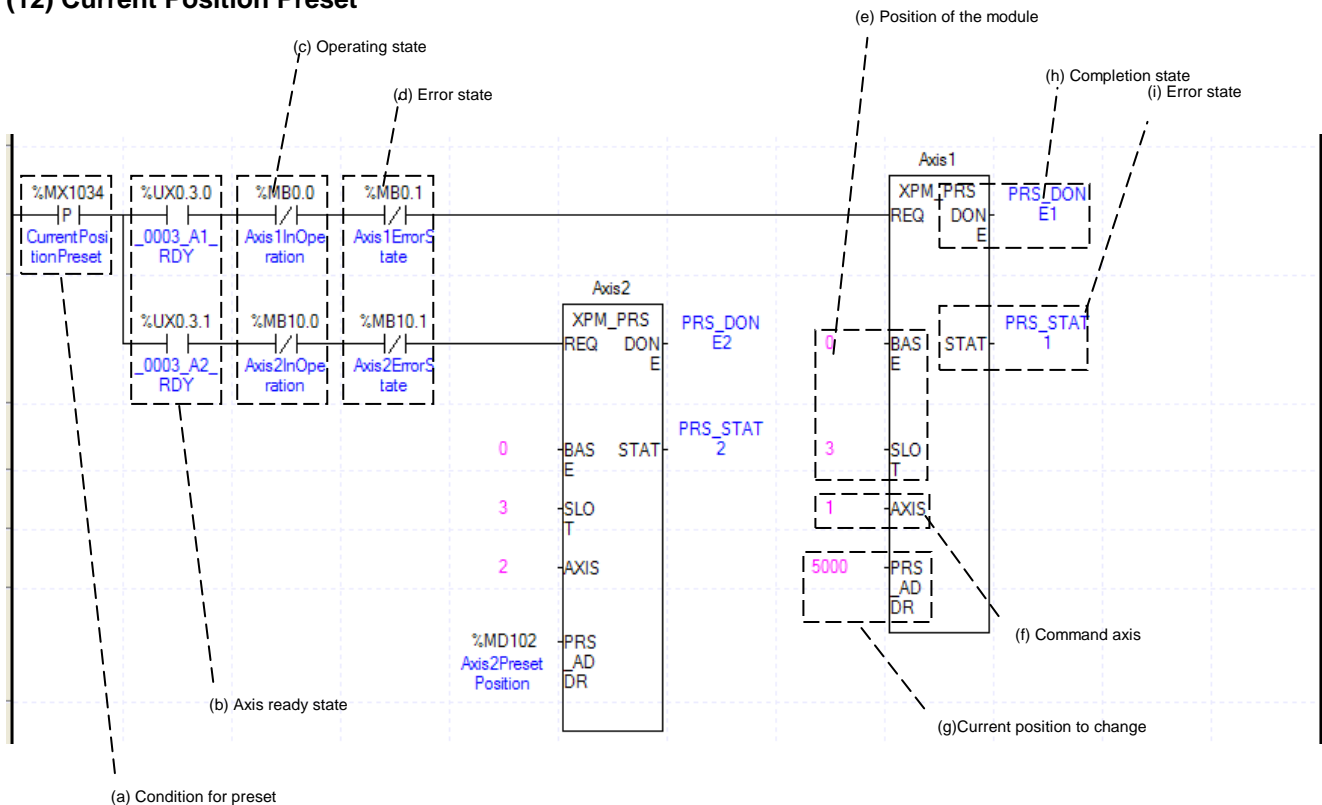

- (a) This is the condition for Current Position Preset
This is the condition for Current Position Preset Command (XPM_PRS). Once Current Position Preset is executed, current operation step will move to set step. If the origin has not set yet, the origin would be set to origin decided.
- (b) Axis ready
If communication between the positioning module and the servo driver is normal, corresponding signal will be on.

(c) Operating state by axis

According to exercise from “Chapter 8.2.2 Current State Reading,” it is a signal of “Operating” for each axis. It turns on when it is operating. Operating Data Setting can not be configured while it is running hence configuration will only be configured when it is not running. If you execute Current Position Preset while it is running, the “error 451” would be appeared.

(d) Error state for each axis

According to exercise from “Chapter 8.2.2 Current State Reading,” it is a signal of “Error state” for each axis. It turns on when an error occurred. Operation will only work when there is no error. If you want to operate a system regardless of errors, you can just inactivate the function.

(e) Address of Positioning Module

In this example, Positioning Module is installed at the 3 slot of 0 bases.

(f) Axis of command execution

You can set an axis for Parameter Setting. XBF-PN04(8)B supports for 4(8) axes. In the “execution of axis” from the configuration of Parameter Setting, you can set a value for axis1 through axis4(8).

(g) Change Current Position

Set change current position by Current Position Preset. Unit follows the value from “Unit” of basic parameter. In the example, Axis1 and axis2 are changed to 5000 and the position saved in %MD102.

(h) State of Operation complete

If function block is completed without error, “1” will be outputted and maintain “1” until the next operation. If error occurred, “0” will be outputted.

(i) Error State

This is the area that output error no. if there are errors in operation of function block.

(j) For more information, reference of Current Position Preset is in the “Chapter 9.5.7.”

(13) Encoder Preset

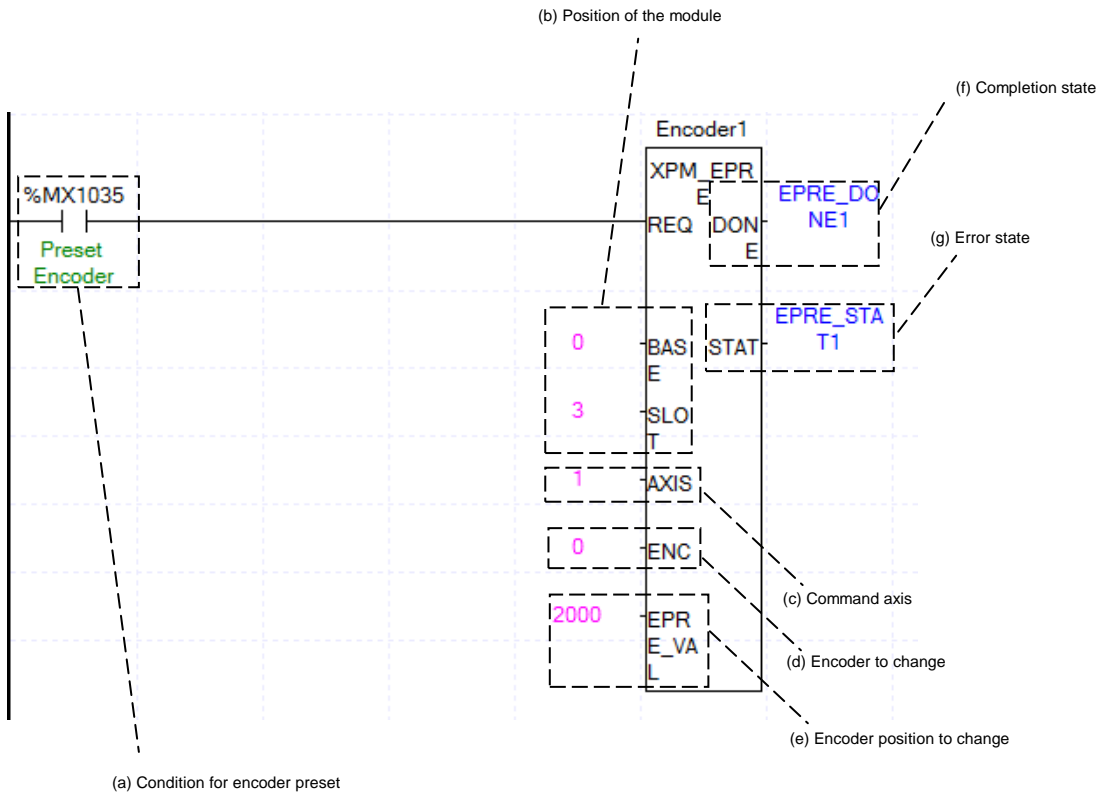

- (a) This is the condition for Encoder Preset
This is the condition for Encoder Preset Command (XPM_EPRS). Once Encoder Preset is executed, current operation step will move to set step.
- (b) Address of Positioning Module
In this example, Positioning Module is installed at the 3 slot of 0 bases.
- (c) Axis of command execution
You can set an axis for Parameter Setting. XBF-PN04(8)B supports for 4(8) axes. In the “execution of axis” from the configuration of Parameter Setting, you can set a value for axis1 through axis4(8).
- (d) Changing Encoder
Set Changing Encoder to execute a preset. 0 means “Encoder1”.
- (e) Changing Encoder Position
Set for Changing Encoder Position. In the example, the encoder1 position is changed to 2000.
- (f) State of Operation complete
If function block is completed without error, “1” will be outputted and maintain “1” until the next operation. If error occurred, “0” will be outputted.
- (g) Error State
This is the area that output error no. if there are errors in operation of function block.
- (h) For more information, reference of Encoder Preset is in the “Chapter 9.5.8.”

(14) Reset Latch

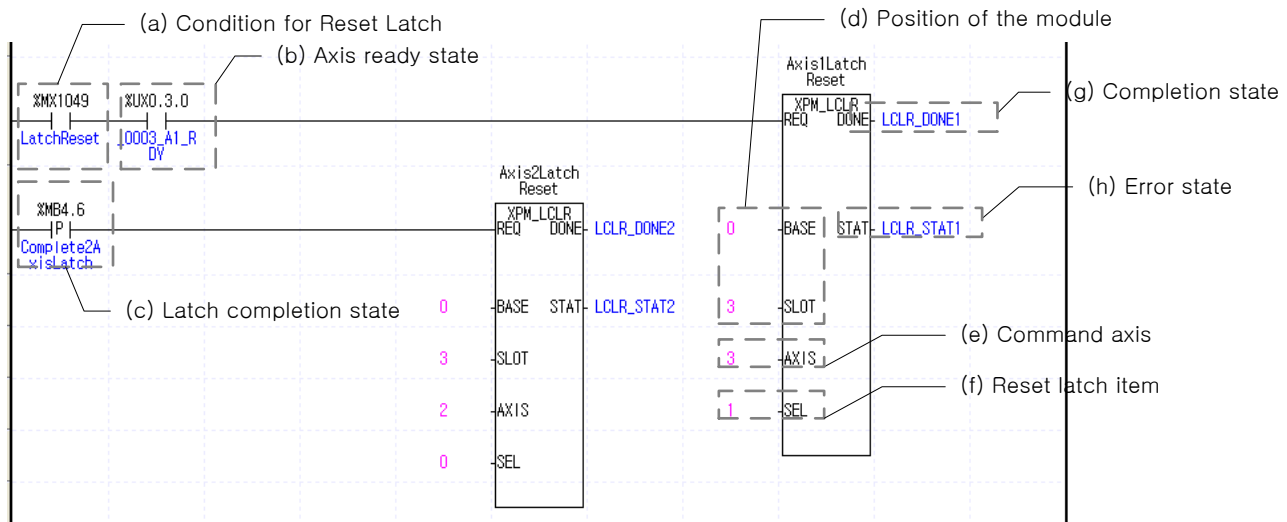

- (a) This is the condition for Reset Latch
This is the condition for Reset Latch Command (XPM_LCLR). Once Reset Latch is executed, it reset state of latch completion or latch data by set the reset latch item.
- (b) Axis ready
If communication between the positioning module and the servo driver is normal, corresponding signal will be on.
- (c) Latch completion state
It is the state of "Latch Completion" when an example program of "8.2.2 Read the Current State." It is on when latch is completed once external latch command signal of the relevant axis is inputted. In case of Axis 2, the Reset latch item is executed as soon as %MB4.6 (Latch Completion state) is On. To read latch data every time when latch is completed upon the input of the axis's external latch command signal, program to set latch completion as a condition for the Reset Latch command after executing the Read Latch Location Data command.
- (d) Address of Positioning Module
In this example, Positioning Module is installed at the 3 slot of 0 bases.
- (e) Axis of command execution
You can set an axis for Reset Latch. XBF-PN04(8)B supports for 4(8) axes. In the "execution of axis" from the configuration of Reset Latch, you can set a value for axis1 through axis4(8).

(f) Reset latch item

The following items are reset according to the Reset latch item.

- 0: Reset the state when latch is completed
- 1: Reset latch location data and the state when latch is completed

In the example program, latch location data and latch completion are reset for Axis 1 and only latch completion is reset for Axis 2 when executing the Reset Latch command.

(g) State of Operation complete

If function block is completed without error, "1" will be outputted and maintain "1" until the next operation. If error occurred, "0" will be outputted.

(h) Error State

This is the area that output error no. if there are errors in operation of function block.

(15) Set Latch

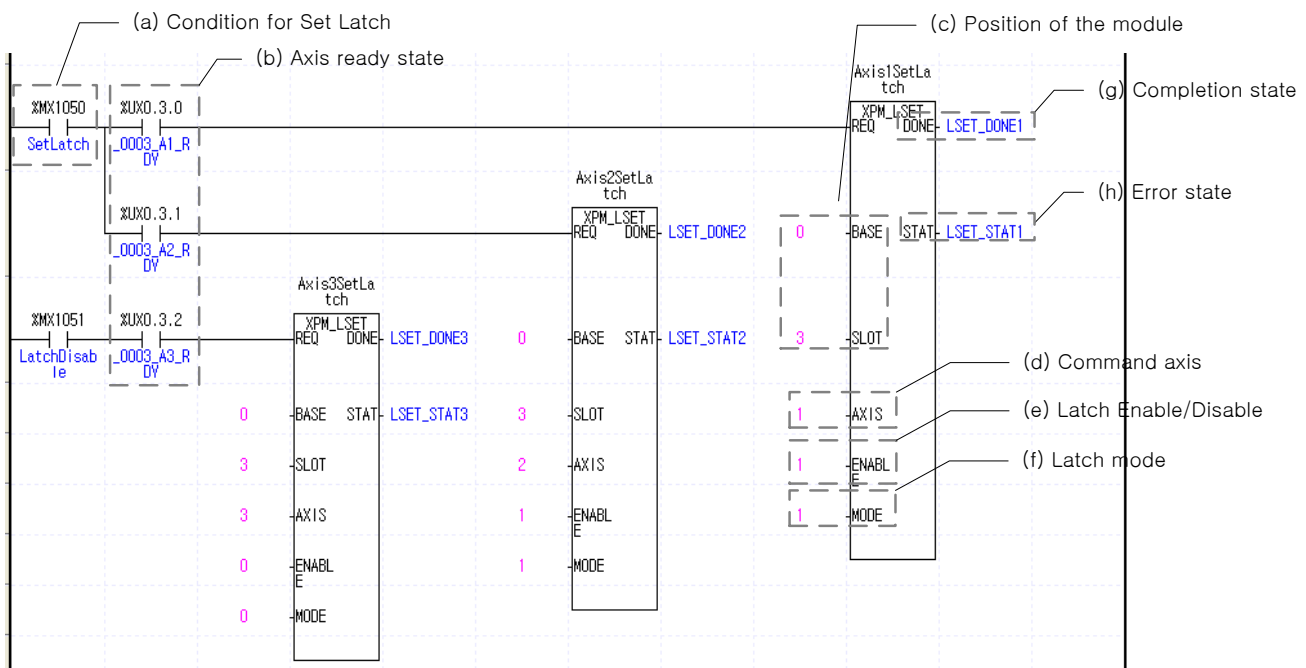

(a) This is the condition for Reset Latch

This is the condition for Set Latch Command (XPM_LSET). The Set Latch command is executed on Axis 1 and 2 as soon as %MX1050(Set Latch) is On after the axis is connected to the network and it is executed on Axis 3 as soon as %MX1051(3-Axis Latch Disable) is On.

(b) Axis ready

If communication between the positioning module and the servo driver is normal, corresponding signal will be on.

(c) Address of Positioning Module

In this example, Positioning Module is installed at the 3 slot of 0 bases.

(d) Axis of command execution

You can set an axis for Set Latch. XBF-PN04(8)B supports for 4(8) axes. In the "execution of axis" from the configuration of Set Latch, you can set a value for axis1 through axis4(8).

(e) Latch enable/disable

Actions according to the designated Enable/Disable Latch item are as following:

- 0: latch disable
- 1: latch enable

In the example program, latch is enabled for Axis 1 and 2 while it is disabled for Axis 3.

(f) Latch mode item

Actions according to the designated latch mode item are as following:

0: Single trigger (The current position latch is available only the touch probe 1 signal inputted at first after latch is permitted)

1: Continuous trigger (The current position latch is available at every touch probe 1 signal after latch is permitted)

In the example program, Axis 1 is set in the single trigger mode while Axis 2 is set in the continuous trigger mode when implementing the Set Latch command.

(g) State of Operation complete

If function block is completed without error, "1" will be outputted and maintain "1" until the next operation. If error occurred, "0" will be outputted.

(h) Error State

This is the area that output error no. if there are errors in operation of function block.

8.2.8 Error

(1) Error Reset

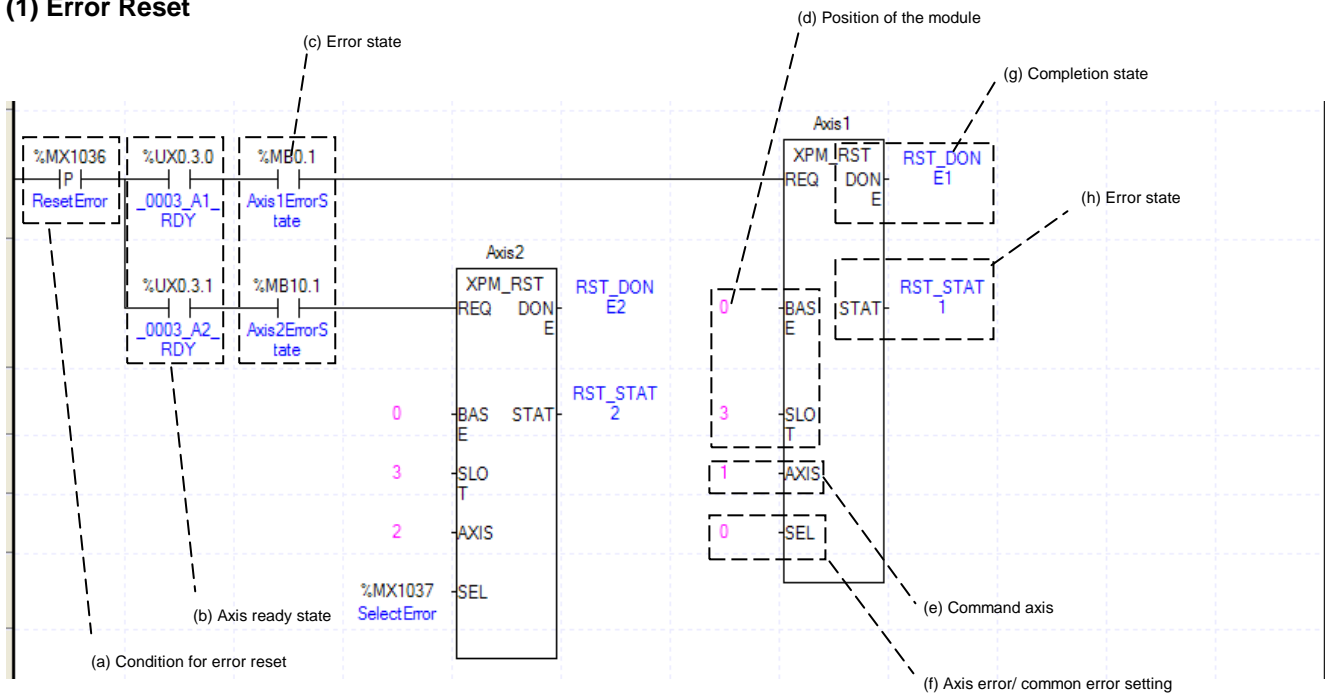

- (a) This is the condition for Error Reset
This is the condition for Error Reset Command (XPM_RST). Once Error Reset is executed, it erases errors of module form each axis.
- (b) Axis ready
If communication between the positioning module and the servo driver is normal, corresponding signal will be on.
- (c) Error state for each axis
According to exercise from “Chapter 8.2.2 Current State Reading,” it is a signal of “Error state” for each axis. It turns on when an error occurred. Operation will only work when there is no error. If you want to operate a system regardless of errors, you can just inactivate the function.
- (d) Address of Positioning Module
In this example, Positioning Module is installed at the 3 slot of 0 bases.
- (e) Axis of command execution
You can set an axis for Parameter Setting. XBF-PN04(8)B supports for 4(8) axes. In the “execution of axis” from the configuration of Parameter Setting, you can set a value for axis1 through axis4(8).
- (f) Error setting of Error/Common by axis
Depending on the errors, if it is set by “0”, erase the errors in operation of each axis, if it is set by “1”, erase the common errors of each modules.
- (g) State of Operation complete
If function block is completed without error, “1” will be outputted and maintain “1” until the next operation. If error occurred, “0” will be outputted.
- (h) Error State
This is the area that output error no. if there are errors in operation of function block.

(2) Error History Reset

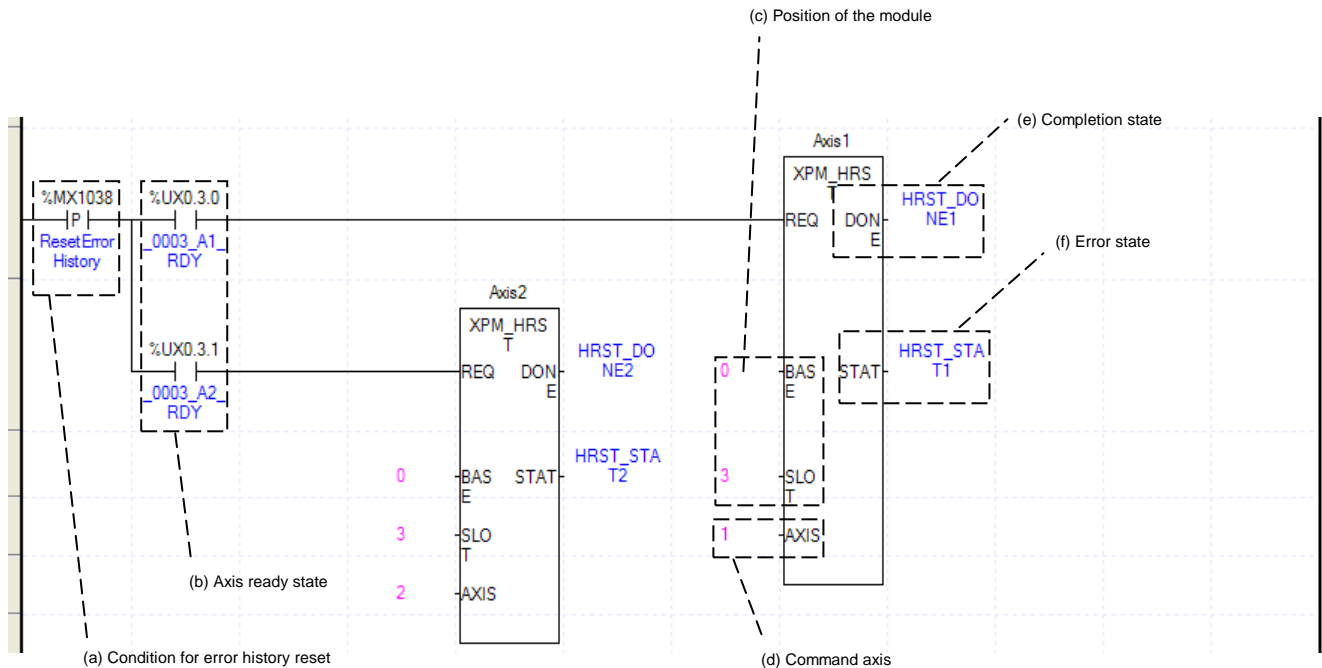

(a) This is the condition for Error History Reset

This is the condition for Error History Reset Command (XPM_HRST). Once Error Reset is executed, it erases history of generated errors of module. XBF-PN04B/PN08B has ten error histories by each axis. It will be saved to MRAM, remain still even there is no power.

(b) Axis ready

If communication between the positioning module and the servo driver is normal, corresponding signal will be on.

(c) Address of Positioning Module

In this example, Positioning Module is installed at the 3 slot of 0 bases.

(d) Axis of command execution

You can set an axis for Parameter Setting. XBF-PN04(8)B supports for 4(8) axes. In the "execution of axis" from the configuration of Parameter Setting, you can set a value for axis1 through axis 4(8).

(e) State of Operation complete

If function block is completed without error, "1" will be outputted and maintain "1" until the next operation. If error occurred, "0" will be outputted.

(f) Error State

This is the area that output error no. if there are errors in operation of function block.

(3) Servo Driver Error Reset

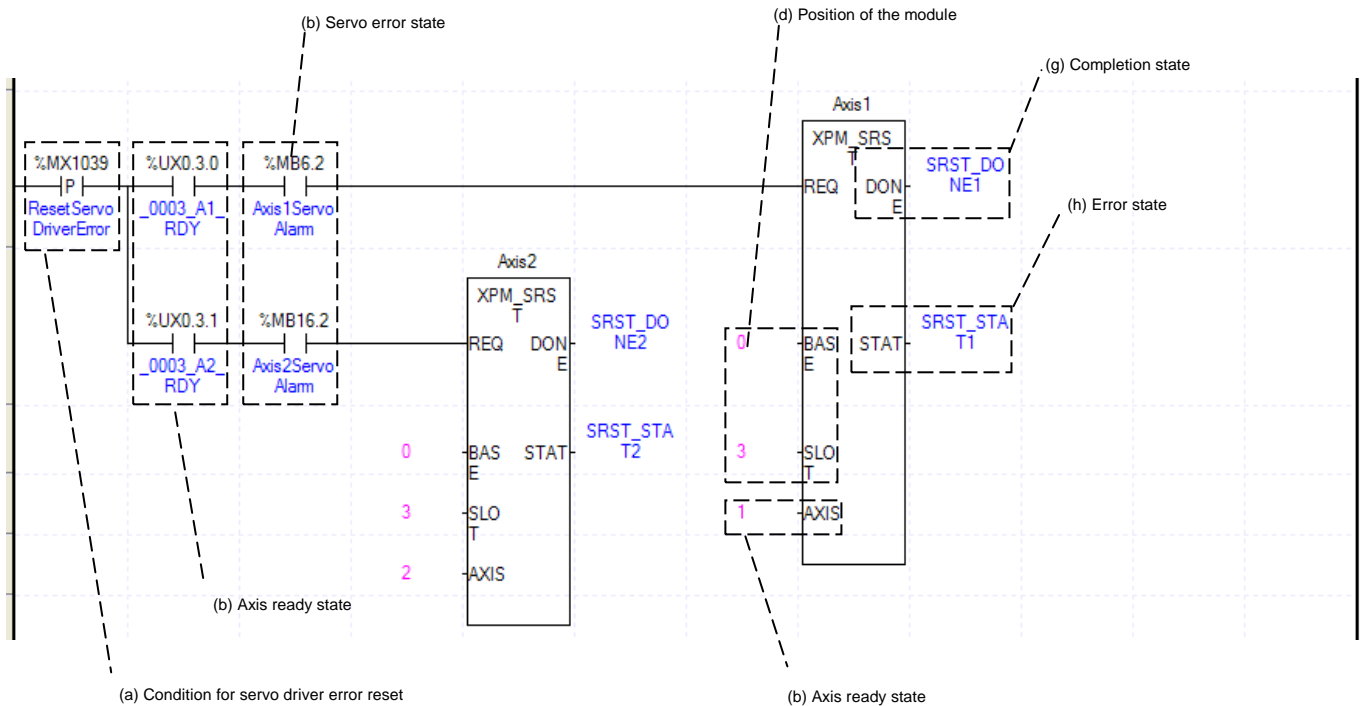

(a) This is the condition for Servo Driver Error Reset

This is the condition for Servo Driver Error Reset Command (XPM_SRST). Once Servo Driver Error Reset is executed, it erases errors of module form each axis. At this time, if you execute this command without removing causes of error, error may ramin.

(b) Axis ready

If communication between the positioning module and the servo driver is normal, corresponding signal will be on.

(c) Error state for each axis

According to exercise from “Chapter 8.2.2 Current State Reading,” it is a signal of “Error state” for each axis. It turns on when an error occurred. Operation will only work when there is no error. If you want to operate a system regardless of errors, you can just inactivate the function.

(d) Address of Positioning Module

In this example, Positioning Module is installed at the 3 slot of 0 bases.

(e) Axis of command execution

You can set an axis for Parameter Setting. XBF-PN04(8)B supports for 4(8) axes. In the “execution of axis” from the configuration of Parameter Setting, you can set a value for axis1 through axis4(8).

(f) State of Operation complete

If function block is completed without error, “1” will be outputted and maintain “1” until the next operation. If error occurred, “0” will be outputted.

(g) Error State

This is the area that output error no. if there are errors in operation of function block.

(4) Servo Driver Error History Reset

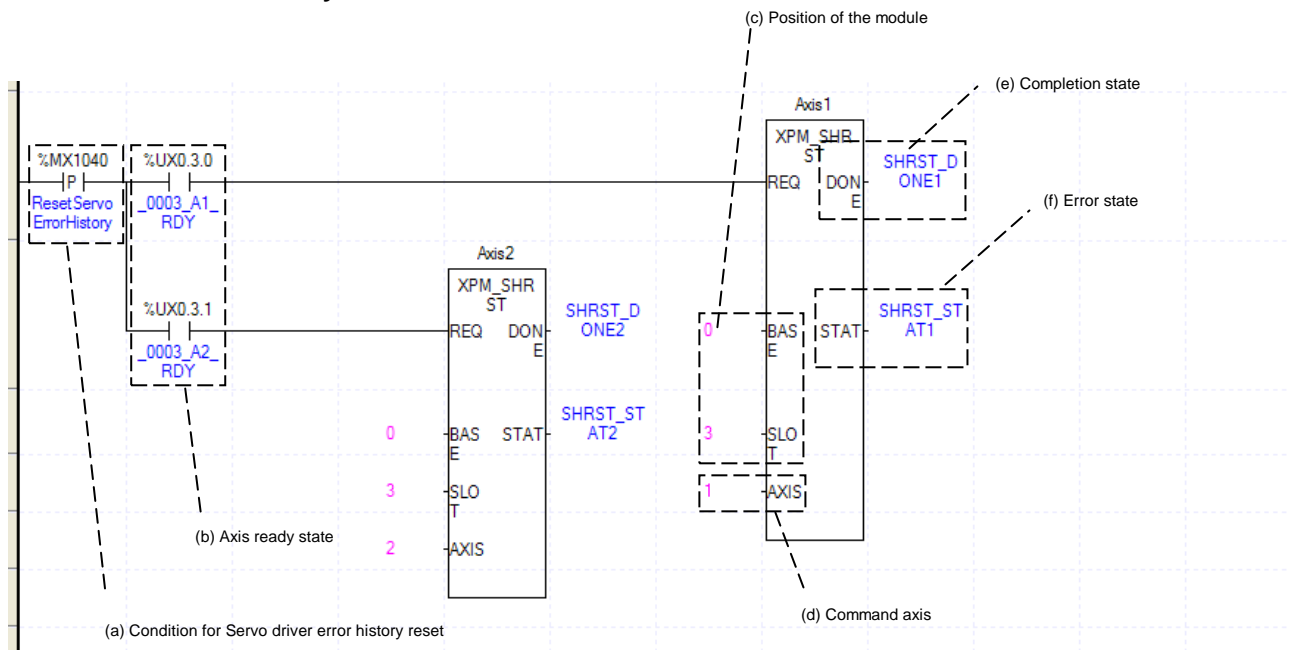

(a) This is the condition for Servo Driver Error History Reset

This is the condition for Servo Driver Error History Reset Command (XPM_SHRST). Once Servo Driver Error Reset is executed, it erases history of generated errors of servo driver. Servo driver can have ten error histories by each axis.

(b) Axis ready

If communication between the positioning module and the servo driver is normal, corresponding signal will be on.

(c) Address of Positioning Module

In this example, Positioning Module is installed at the 3 slot of 0 bases.

(d) Axis of command execution

You can set an axis for Parameter Setting. XBF-PN04(8)B supports for 4(8) axes. In the "execution of axis" from the configuration of Parameter Setting, you can set a value for axis1 through axis 4(8).

(e) State of Operation complete

If function block is completed without error, "1" will be outputted and maintain "1" until the next operation. If error occurred, "0" will be outputted.

(f) Error State

This is the area that output error no. if there are errors in operation of function block.

8.2.9 Program related with Servo Parameter

(1) Servo Driver Parameter Read

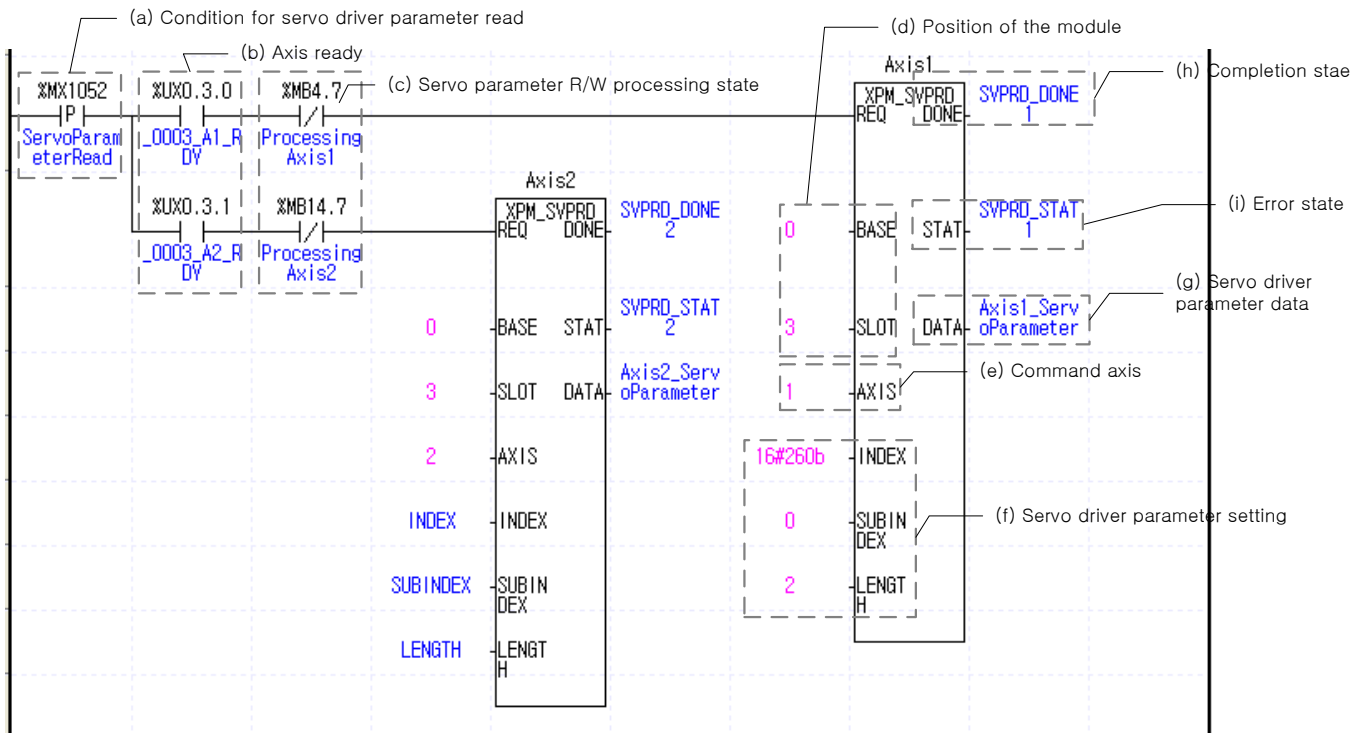

- (a) This is the condition for Servo Drive Parameter Read
This is the condition for Servo Driver Parameter Read Command (XPM_SVPRD). Once “Servo Driver Parameter Read” command is executed, it saves to read parameter object value of the servo driver.
- (b) Axis ready
If communication between the positioning module and the servo driver is normal, corresponding signal will be on.
- (c) Servo parameter R/W processing state
It indicates the executing state of “Servo Driver Parameter Read/Write” or “EEPROM Save” command. In the example, “Servo Driver Parameter Read” command executes when servo parameter R/W processing is off.
- (d) Address of Positioning Module
In this example, Positioning Module is installed at the 3 slot of 0 bases.
- (e) Axis of command execution
You can set an axis for Servo Driver Parameter Read. XBF-PN04(8)B supports for 4(8) axes. In the “execution of axis” from the configuration of Servo Driver Parameter Read, you can set a value for axis1 through axis 4(8).
- (f) Set servo driver parameter
Set index number, SubIndex number, Size of reading parameter object in servo drive parameters. In this example, save to “Axis1_ServoParameter” to read axis1 servo DCLink voltage of specified by h260b:00 with 2byte size. Save to “Axis2_ServoParameter” to read axis2 servo parameter of specified by INDEX, SUBINDEX with LENGTH size.
- (g) Servo Parameter Data
It sets up data to read to the servo driver parameter.
- (h) State of Operation complete
If function block is completed without error, “1” will be outputted and maintain “1” until the next operation. If error occurred, “0” will be outputted.
- (i) Error State
This is the area that output error no. if there are errors in operation of function block.

(2) Servo Driver Parameter Write

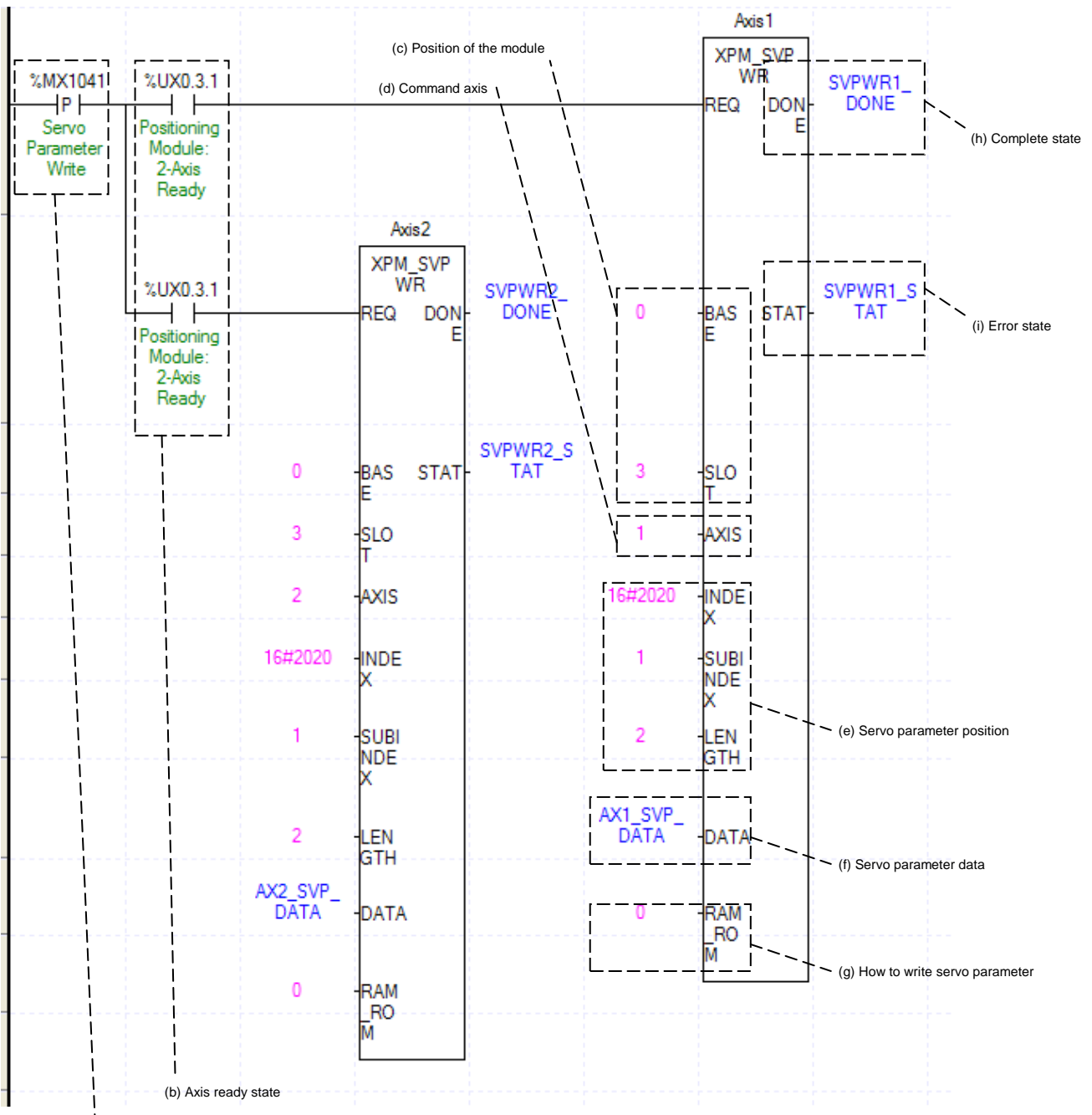

(a) Condition for Servo Driver Parameter Write

(a) This is the condition for Servo Parameter Write

This is the condition for Servo Parameter Write Command (XPM_SVPWR). Once “Servo Parameter Write” command is executed, it changes parameter value of the servo driver into setting value

(b) Axis ready

If communication between the positioning module and the servo driver is normal, corresponding signal will be on.

(c) Address of Positioning Module

In this example, Positioning Module is installed at the 3 slot of 0 bases.

(d) Axis of command execution

You can set an axis for Parameter Setting. XBF-PN04(8)B supports for 4(8) axes. In the “execution of axis” from the configuration of Parameter Setting, you can set a value for axis1 through axis 4(8).

- (e) Servo Parameter Position
It sets position of the servo parameter to write. In INDEX, set up Index number of the servo parameter object, and in SUBINDEX, set up sub-index number of the servo parameter object, and in LENGTH, set up length of the servo parameter by byte unit.
- (f) Servo Parameter Data
It sets up data to write to the servo parameter.
- (g) How to write the servo parameter
It sets how to write the servo parameter. If it is set as 0, servo parameter will be written at RAM. And if it is set as 1, servo parameter will be written at EEPROM.
- (h) State of Operation complete
If function block is completed without error, "1" will be outputted and maintain "1" until the next operation. If error occurred, "0" will be outputted.
- (i) Error State
This is the area that output error no. if there are errors in operation of function block.

(2) Servo Driver Parameter Save

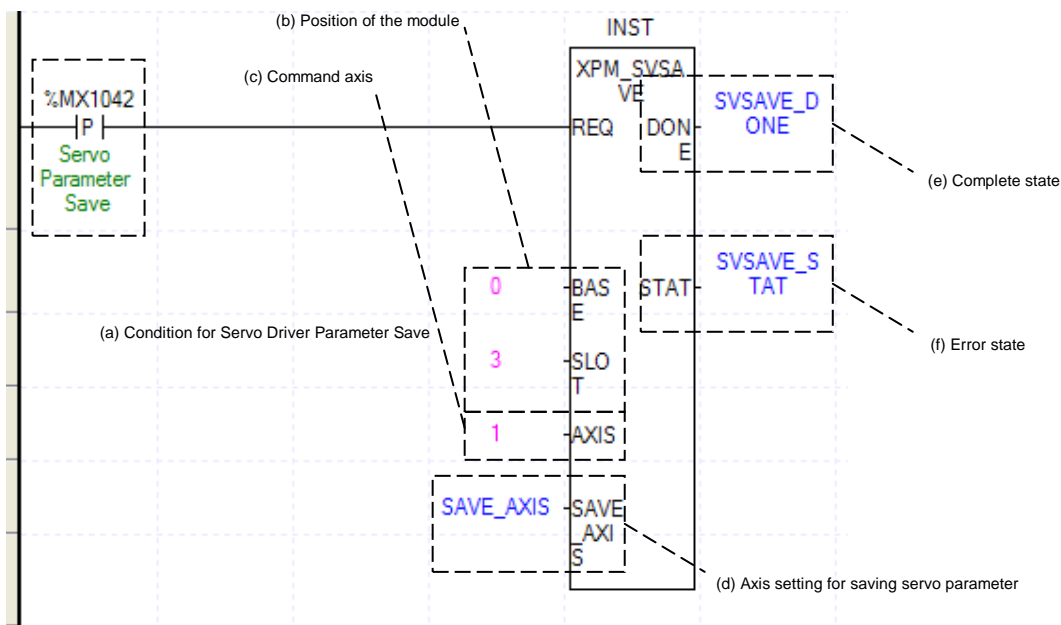

- (a) This is the condition for Servo Parameter Save
This is the condition for Servo Parameter Save Command (XPM_SVSAVE). Once "Servo Parameter Save" command is executed, it saves all parameter values of the servo driver at the internal EEPROM.
- (b) Address of Positioning Module
In this example, Positioning Module is installed at the 3 slot of 0 bases.
- (c) Axis of command execution
You can set an axis for Parameter Setting. XBF-PN04(8)B supports for 4(8) axes. In the "execution of axis" from the configuration of Parameter Setting, you can set a value for axis1 through axis 4(8).
- (d) Axis setting for saving servo parameter
It sets the axis of the servo driver to save. Each axis of 1-axis ~ 8-axis is assigned with 0~7 bit. Set the corresponding bit to select the axis.
- (e) State of Operation complete
If function block is completed without error, "1" will be outputted and maintain "1" until the next operation. If error occurred, "0" will be outputted.
- (f) Error State
This is the area that output error no. if there are errors in operation of function block.

Chapter 9 Functions

9.1 Home Return

Home Return is carried out to confirm the origin of the machine when applying the power. In case of homing, it is required to set the parameters related with homing among servo parameters per axis. If the origin position is determined by homing, the origin detection signal is not recognized during positioning operation. In case of homing, the needed contact point is inputted through a CN1 connector of a servo driver (EtherCAT CoE-supported servo driver).

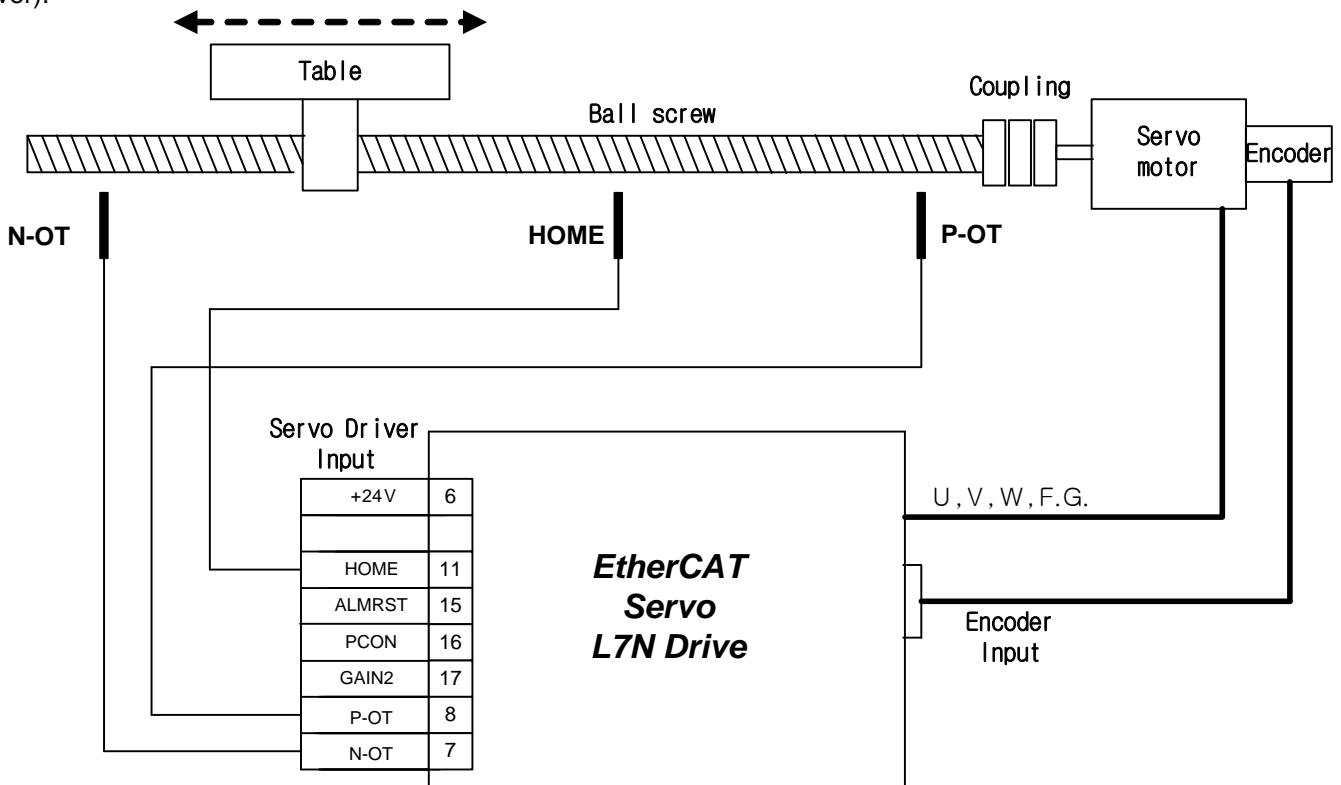

For home return, select "Home return method" (EtherCAT CoE-supported driver: refer to manual) according to user system. In motion control module, actual execution is performed in servo driver after home return execution. Besides supported home return method conforms related servo drive. The parameters of axis those are related with home return in servo parameters must be configured before home return setting.

■Setting example of parameter home return

Index	Name	Unit	Current Value	Initial Value	Access
6098	Homing Method	-	34	34	rw
6099:00	Homing Speeds	-	2	2	rw
6099:01	Speed during search for switch	Vel,Unit	160	160	rw
6099:02	Speed during search for zero	Vel,Unit	32	32	rw
609A	Homing Acceleration	Acc,Unit	50000	50000	rw

(1) Relevant parameter of home return

Index	Sub	Name	Data Type	Unit
0x6040	-	Control word	UINT	-
0x6041	-	Status word	UINT	-
0x607C	-	Home offset	DINT	[pls]
0x6098	-	Homing method	SINT	-
0x6099	-	Homing speeds	-	-
	0	Number of item	USINT	-
	1	Speed during search for switch	UDINT	[pls/s]
	2	Speed during search for zero	UDINT	[pls/s]
0x607D	-	Software position limit	-	-
	0	Number of item	USINT	-
	1	Minimum position limit	DINT	[pls]
	2	Maximum position limit	DINT	[pls]
0x609A	-	Homing acceleration	UDINT	[pls/s ²]

Homing Method (0x6098)	Details
1	The drive returns to the home position with the negative limit switch (NOT) and the Index (Z) pulse while driving in the reverse direction.
2	The drive returns to the home position with the positive limit switch (POT) and the Index (Z) pulse while driving in the forward direction.
7, 8, 9, 10	The drive returns to the home position with the home switch (HOME) and the Index (Z) pulse while driving in the forward direction. When the positive limit switch (POT) is input during homing, the drive will switch its driving direction.
11, 12, 13, 14	The drive returns to the home position with the home switch (HOME) and the Index (Z) pulse while driving in the reverse direction. When the negative limit switch (NOT) is input during homing, the drive will switch its driving direction.
24	The drive returns to the home position with the home switch (HOME) while driving in the forward direction. When the positive limit switch (POT) is input during homing, the drive will switch its driving direction.
28	The drive returns to the home position with the home switch (HOME) while driving in the reverse direction. When the negative limit switch (NOT) is input during homing, the drive will switch its driving direction.
33	The drive returns to the home position with the Index (Z) pulse while driving in the reverse direction.
34	The drive returns to the home position with the Index (Z) pulse while driving in the forward direction.
35	Sets the current position as the origin.
-1	The drive returns to the home position with the negative stopper and the Index (Z) pulse while driving in the reverse direction.
-2	The drive returns to the home position with the positive stopper and the Index (Z) pulse while driving in the forward direction.
-3	The drive returns to the home position with the negative stopper while driving in the reverse direction.
-4	The drive returns to the home position with the positive stopper while driving in the forward direction.
-5	The driver returns to the home position in the reverse direction with the home switch(HOME)
-6	The driver returns to the home position in the forward direction with the home switch(HOME)

(2) Homing method (0x6098)

Value	Details
1, 2	<p>(1) If NOT-Switch is turned-off, starting move direction becomes CW (clock wise). If NOT-Switch is turned-on, move direction is changed as CCW (counter clock wise). While operate in the CCW after NOT-Switch is turned-off, the first point of contact with index pulse will be home position.</p> <p>(2) If POT-Switch is turned-off, starting move direction becomes CCW (counter clock wise). If POT-Switch is turned-on, move direction is changed as CW (clock wise). While operate in the CW after POT-Switch is turned-on, the first point of contact with index pulse will be home position.</p>
7 to 10	<p>Method (7) ~ (10) determine the home position by a HOME or POT switch.</p> <p>(7)_Upper figure: If POT-Switch is turned-off, starting move direction becomes CCW (counter clock wise) with switch searching speed. If HOME-Switch is turned-on, move direction is changed as CW (clock wise). After while operate in the CW, the first point of contact with index pulse will be home position and operating with zero searching speed.</p> <p>(7)_Middle figure: If POT-Switch is turned-off and HOME-Switch is turned-on, starting move direction becomes CW (counter clock wise) with switch searching speed. If HOME-Switch is turned-off, operating speed is changed as zero searching speed. After while operate in the CW, the first point of contact with index pulse will be home position.</p> <p>(7)_Lower figure: If POT-Switch is turned-off and HOME-Switch is turned-on, starting move direction becomes CCW (counter clock wise) with switch searching speed. If POT-Switch is turned-on, move direction is changed as CW (clock wise). When HOME-Switch is changed as ON to OFF, operating speed is changed as zero searching speed. After while continue to operate in the CW, the first point of contact with index pulse will be home position.</p> <p>The other method (8) ~ (10) are same as positioning operation of method (7) except for operations in accordance with the polarity switch. Please refer to the follow,</p>

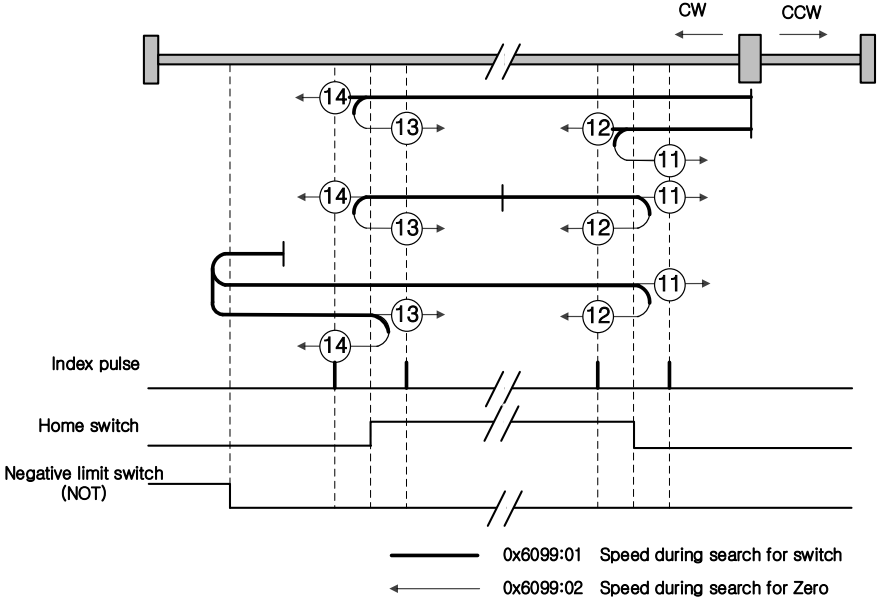
Value	Details
<p>11 to 14</p>	<p>For homing using the Homing Method 14, the velocity profile according to the sequence is as follows. The sequence depends on the relationship between the location of load and the Home switch at homing, which is categorized into three cases as below. For more information, see the details below:</p> <p>(14) Upper figure: The initial driving direction is CW (clock wise), and the drive operates at the Switch Search Speed. When the Negative Home Switch is turned off, the drive will decelerate to Zero Search Speed, and then continue to operate. While operating at the Zero Search Speed, the drive detects the first index pulse to move to the index position (Home).</p> <p>(14) Middle figure: Since the Home signal is on, the drive will operate at the Switch Search Speed in the direction of the Negative Home Switch (CW). It might not reach the Switch Search Speed depending on the start position of homing. When the Home switch is turned off, the drive will decelerate to Zero Search Speed, and then continue to operate. While operating at the Zero Search Speed, the drive detects the first index pulse to move to the index position (Home).</p> <p>(14) Lower figure: The initial driving direction is CW (clock wise), and the drive operates at the Switch Search Speed. When the negative limit switch (NOT) is turned on, the drive will decelerate down to stop, and then operate at the Switch Search Speed in the CCW (counter clock wise). When the Negative Home Switch is turned on, the drive will decelerate to the Zero Search Speed, and then switches its direction to the CW (clock wise). While operating at the Zero Search Speed, the drive detects the first index pulse to move to the index position (Home).</p> <p>The methods from 11 to 13 are nearly identical to the method 14 in terms of the homing sequence. The only differences are the initial driving direction and Home switch polarity.</p> 

Value	Details
24	<p>It determines the Home position in the same manner as method 8, but it does not use an index pulse. The point where the Home switch is turned on or off becomes the Home position.</p> <p>←CW →CCW</p> <p>Home switch</p> <p>Positive limit switch (POT)</p>
28	<p>It determines the Home position in the same manner as method 12, but it does not use an index pulse. The point, where the Home switch is turned on or off, becomes the Home position.</p> <p>←CW →CCW</p> <p>Home switch</p> <p>Negative limit switch (NOT)</p>
33, 34	<p>The position that the first index pulse encounters while driving in a CCW/CW direction becomes the Home position.</p> <p>←CW →CCW</p> <p>Index pulse</p>

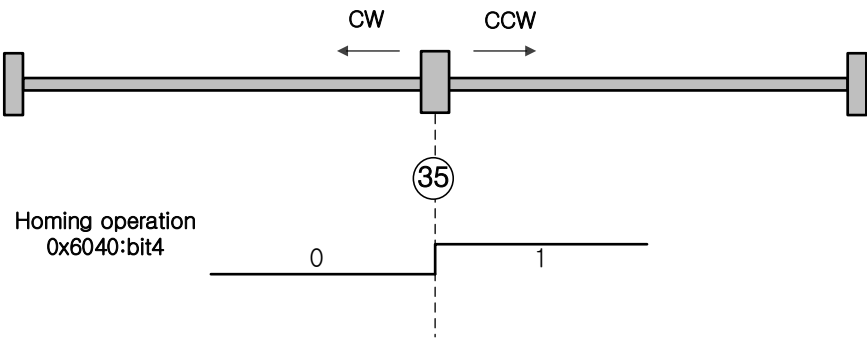
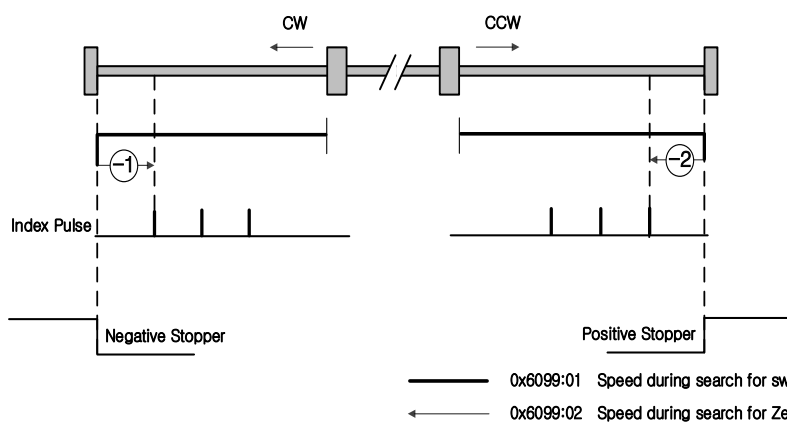
Value	Details
35	<p>The starting point of the homing operation becomes the Home position.</p>  <p>Homing operation 0x6040:bit4</p>
-1, -2	<p>Homing methods -1 and -2 are using Stopper and Index (Z) pulse to home. The velocity profiles depending on the sequence are shown below. For more information, see the details below:</p> <p>(-1) The initial driving direction is CW (clock wise), and the drive operates at the Switch Search Speed. When the drive hits the negative stopper, it will stand by according to the torque limit value (0x2409), and the time setting value (0x240A) at the time of homing using stopper before direction switch. While operating at the Zero Search Speed, the drive detects the first index pulse to move to the index position (Home).</p> <p>(-2) The initial driving direction is CCW (counter clock wise), and the drive operates at the Switch Search Speed. When the drive hits the positive stopper, it will stand by according to the torque limit value (0x2409) and the time setting value (0x240A) at the time of homing using stopper before direction switch. While operating at the Zero Search Speed, the drive detects the first index pulse to move to the index position (Home).</p>  <p>Index Pulse</p> <p>Negative Stopper</p> <p>Positive Stopper</p> <p>— 0x6099:01 Speed during search for switch ← 0x6099:02 Speed during search for Zero</p>

Value	Details
-3,-4	<p>Homing method -3 and -4 are using Stopper to home. The velocity profiles depending on the sequence are shown below.</p> <p>(-3) The initial driving direction is counter forward (CW), and the drive operates at the Switch</p>

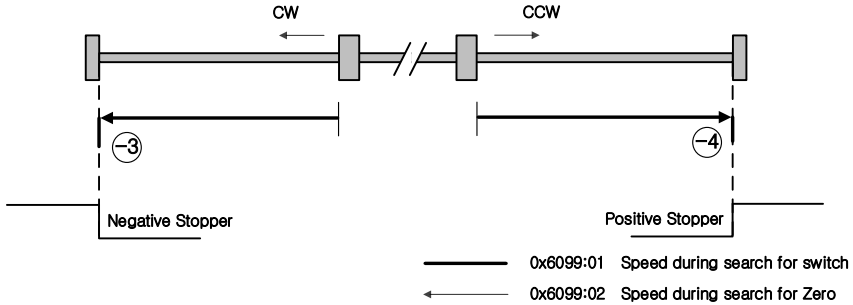
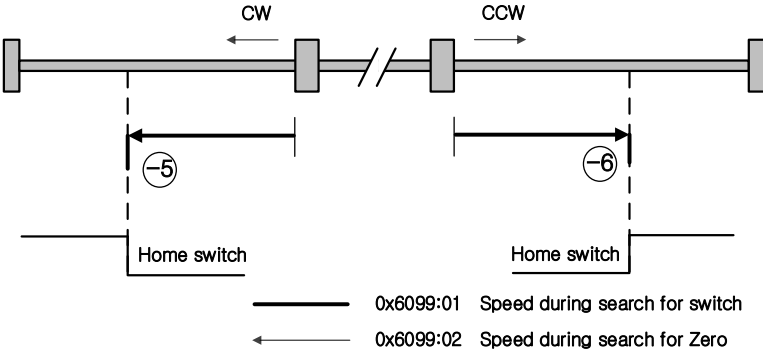
Value	Details
	<p>Search Speed. When the drive hits the negative Stopper, it will stand by according to the torque limit value (0x2409), and the time setting value (0x240A) at the time of homing using stopper before direction switch.</p> <p>(-4) The initial driving direction is CCW (counter clock wise), and the drive operates at the Switch Search Speed. When the drive hits the positive Stopper, it will stand by according to the torque limit value (0x2409), and the time setting value (0x240A) at the time of homing using stopper before direction switch.</p> 
-5,-6	<p>Homing methods -5, -6 are using home switch</p> <p>(-5) The initial movement is CW direction with Switch Search Speed. When positive home switch is ON, home return is completed after deceleration stop.</p> <p>(-6) The initial movement is CCW direction with Switch Search Speed. When positive home switch is ON, home return is completed after deceleration stop.</p> 

Comment) — : Speed during search for switch (0x6099:01),

→ : Speed during search for zero (0x6099:02)

9.2 Positioning Control

Positioning control executes using data which is set on the 「Operation Data」. Positioning control includes Single-axis Position control, Single-axis Speed Control, Single-axis Feed Control, Interpolation control, Speed/Position Switching control, Position/Speed Switching control and Position/Torque Switching control.

Positioning Control		Control Method	Operation
Positioning Control	Single-axis Position Control	Absolute, Single-axis Position Control Incremental, Single-axis Position Control	Specified axis executes positioning control from the beginning (current stop position) to the goal position.
	Single-axis Feed Control	Absolute, Single-axis Feed Control Incremental, Single-axis Feed Control	The starting position (the current stop position) changes to 0 and executes positioning control as far as specified moving amount.
	Linear Interpolation	Absolute, Linear Interpolation Incremental, Linear Interpolation	Executes linear interpolation control by using specified axes from the start position (current stop position) to the target position.
	Circular Interpolation	Absolute, Circular Interpolation Incremental, Circular Interpolation	Executes positioning control by using 2 axes, controlling sub-axis in accordance with the data of command axis (main axis), to target position with the trajectory of arc
	Helical Interpolation		Executes positioning control by using 3 axes, controlling sub-axis in accordance with the data of command axis (main axis), to target position with the trajectory of arc. The axis set as helical interpolation axis executes linear interpolation until target position
	Ellipse Interpolation		Executes positioning control by using 2 axes, controlling sub-axis in accordance with the data of command axis (main axis), to target position with the trajectory of ellipse having specified angle.
Speed Control	Absolute, Single-axis Speed Control Incremental, Single-axis Speed Control		Execute Speed control with specified speed until deceleration stop command is entered.
Speed/Position Switching Control	Absolute, Single-axis Speed Control Incremental, Single-axis Speed Control	If speed / position switching command or speed / position control switching input signal is entered during speed control operation, speed control switches to position control and it executes positioning control as far as target position (moving amount).	
Position/Speed Switching Control	Absolute, Single-axis Position Control Incremental, single-axis Position Control	If position/speed switching command is executed during position control operation, position control switches to speed control and it executes speed control with specified speed until deceleration stop command is entered.	
Position/Torque Switching Control	Absolute, Single-axis Position Control Incremental, single-axis Position Control	If position/torque switching command is executed during position control operation, position control switches to torque control and it executes torque control with specified torque until deceleration stop command is entered.	

9.2.1 Operation Data for Positioning Control

Describe the Operation data and Setting to execute positioning control.

Operation Data	Setting
Control Method	Sets the Type of control and standard coordinate of Positioning control.
Operation Method	Sets the control method of continuous operation.
Target Position	Sets the absolute target position or moving amount in case of position control.
Operation Speed	Sets the operation speed.
Acceleration No.	Sets the number to be used as acceleration time. Acceleration No. is selected among Acceleration No. 1, 2, 3, and 4 of basic parameters
Deceleration No.	Sets the number to be used as deceleration time. Deceleration No. is selected among Deceleration No. 1, 2, 3, and 4 of basic parameters
M Code	Sets the M Code when using the code number for auxiliary operation of positioning control.
Dwell Time	Sets the time needed for servo driver to complete the positioning after positioning the object
Sub Axis Setting	Sets the sub axis for interpolation control.
Circular Interpolation	Sets the auxiliary data (middle point, center point and radius) for circular interpolation.
Circular Interpolation Mode	Sets how to generate the arc (middle point, center point and radius) for circular interpolation.
Circular Interpolation Turn Number	Sets the number of arcs to draw for circular interpolation.
Helical Interpolation	Sets the axis to execute linear operation during helical interpolation.

Remark

For operation data, It is available to set 1~400 steps per each 1~8axis.

9.2.2 Operation mode of Positioning Control

Operation mode of positioning control determines whether to execute the next operation data after executing current operation and how to handle the operation speed.

Operation mode types are as follows.

Control Method	Operation Method	Operation Pattern		Operation
Single-axis Positioning Control	Single	End	○	Ends after the completion of the current step
		Keep	○	Keeps operating the next step after the completion of the current step
		Continuous	○	Operates the current step and the next step with a continuous speed
	Repeat	End	○	Ends after the completion of the current step and changes the Current step number into Repeat Step
		Keep	○	Keeps operating the Repeat Step after the completion of the current step
		Continuous	○	Operates the current step and the Repeat Step with a continuous speed
Single-axis Speed Control	Single	End	○	Speed control operation with operation data of the current step
		Keep	○	Speed control operation with operation data of the current step In case of VTP command, after completing the positioning, keeps operating the next step.
		Continuous	X	Errors
	Repeat	End	○	Speed control operation with operation data of the current step
		Keep	○	Speed control operation with operation data of the current step In case of VTP command, after completing the positioning, keeps operating the step specified by Repeat Step.
		Continuous	X	Errors
Single-axis FEED Control	Single	End	○	Ends after the completion of the current step-Feed control
		Keep	○	Keeps operating the next step after the completion of the current step-Feed control
		Continuous	X	Errors
	Repeat	End	○	Ends after the completion of the current step-Feed control and changes the Current step number into Repeat Step
		Keep	○	Keeps operating the Repeat Step after the completion of the current step-Feed control
		Continuous	X	Errors
Linear Interpolation	Single	End	○	Ends after the completion of the current step Linear interpolation
		Keep	○	Keeps operating the next step after the completion of the current step
		Continuous	○	Operates the current step and the next step with a continuous speed
	Repeat	End	○	Ends after the completion of the current step and changes the Current step number into Repeat Step
		Keep	○	Keeps operating the Repeat Step after the completion of the current step
		Continuous	○	Operates the current step and the Repeat Step with a continuous speed

Circular Interpolation	Single	End	○	Ends after the completion of the current step Circular Interpolation
		Keep	○	Keeps operating the next step after the completion of the current step
		Continuous	○	Operates the current step and the next step with a continuous speed
	Single	End	○	Ends after the completion of the current step and changes the Current step number into Repeat Step
		Keep	○	Keeps operating the Repeat Step after the completion of the current step
		Continuous	○	The current step and the next step in a continuous arc interpolation drive speed

Remark

1. Operation mode shall be set from PLC Program or Operation data of XG-PM.
2. Operation data can be set up to 400 ranging from operation step no. 1 ~ 400 per each axis.
3. With one start command, whether to operate one operation step or several operation steps is determined by operation mode set by the user.

(1) End Operation (Single)

- (a) With one time start command, positioning to the target position is executed and the positioning is completed after the dwell time.
- (b) This is used as last operation data of Keep operation mode, Continuous operation mode. (After executing the operation data set as END, it stops)
- (c) Operation direction is determined by target position.
- (d) Generally, operation action is trapezoid type operation that has acceleration, constant, deceleration section according to the operation speed and target position but according to the setting value, the operation pattern can be as follows.

1) Normal Operation Patterns

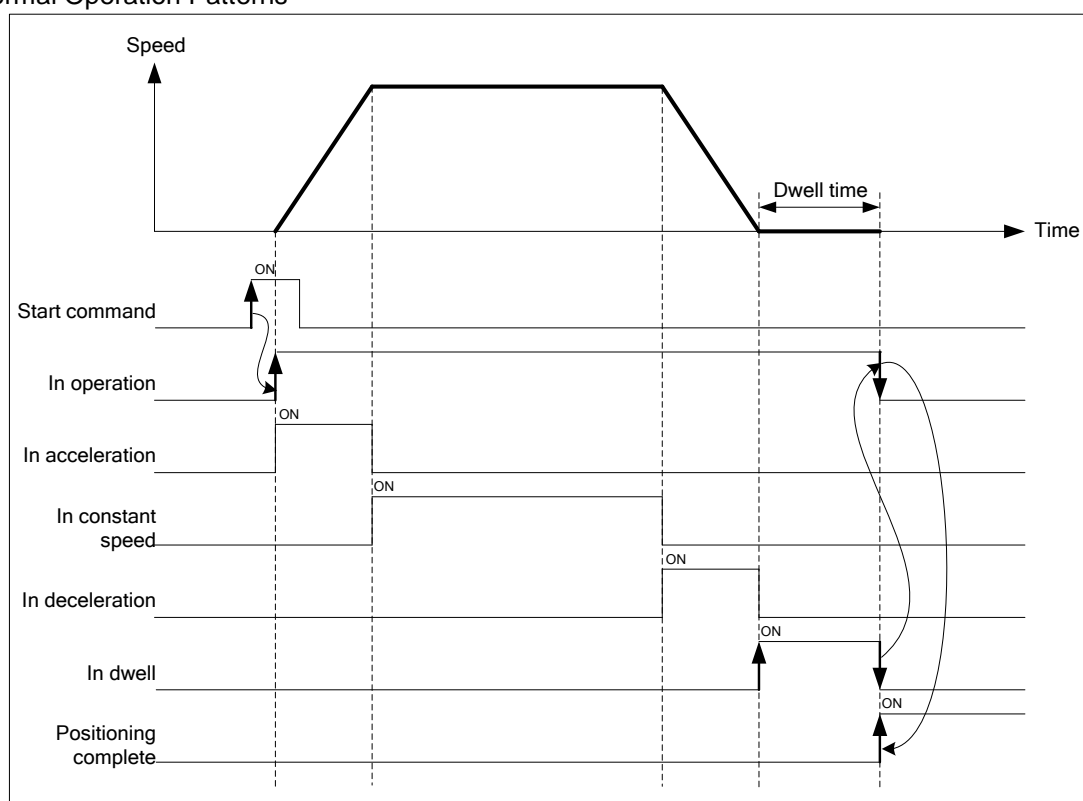

2) Abnormal Operation Patterns

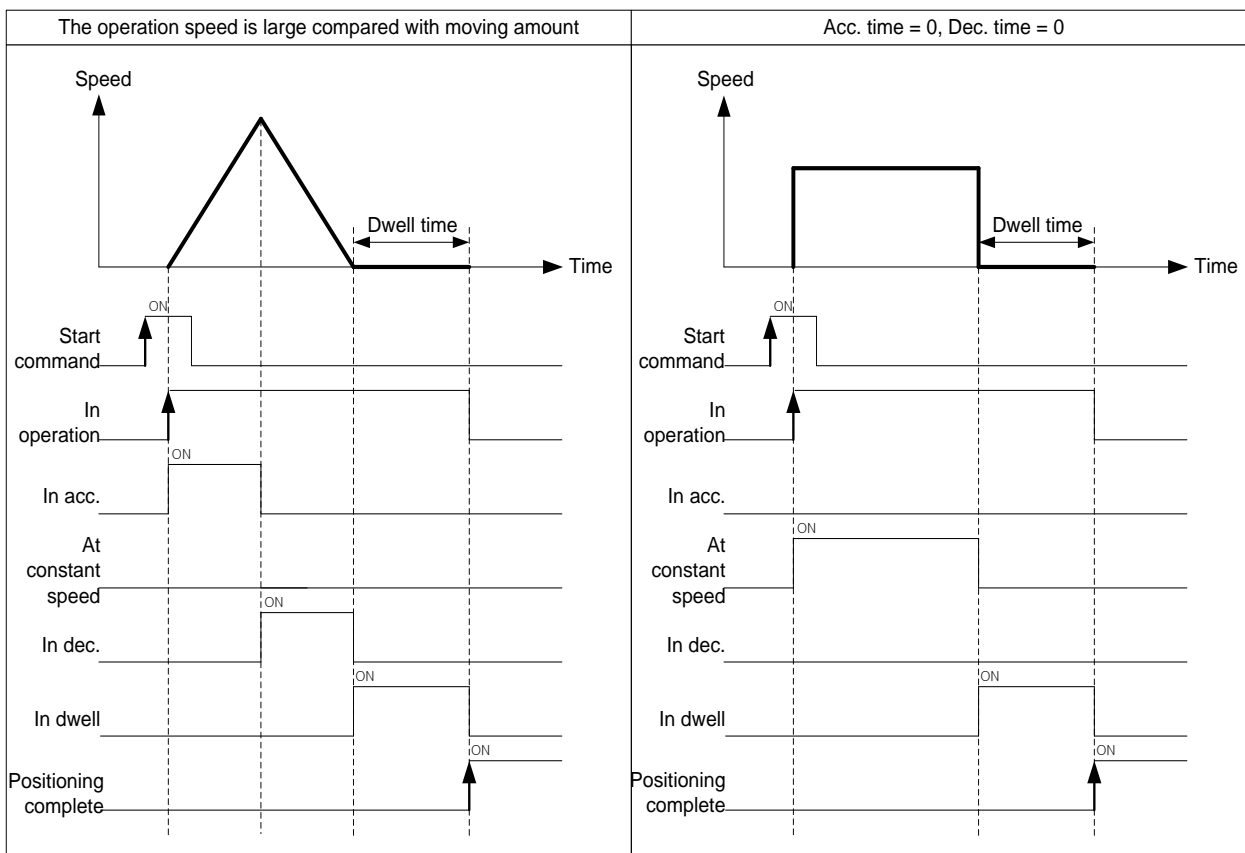

[Example] - Executes Start command after setting the step no. of "Indirect Start" as "0"
 - Execute Start command total four times.

■ Setting of XG-PM

Step NO.	Control type	Operation type	Target Position [pls]	Operation Speed [pls/s]	Accel NO.	Decel NO.	M Code	Dwell Time
1	Absolute Single-axis Position Control	Single, End	10000	1000	1	1	0	0
2	Absolute Single-axis Position Control	Single, End	15000	500	1	1	0	0
3	Absolute Single-axis Position Control	Single, End	25000	1000	1	1	0	0
4	Absolute Single-axis Position Control	Single, End	30000	500	1	1	0	0

■ Operation Pattern

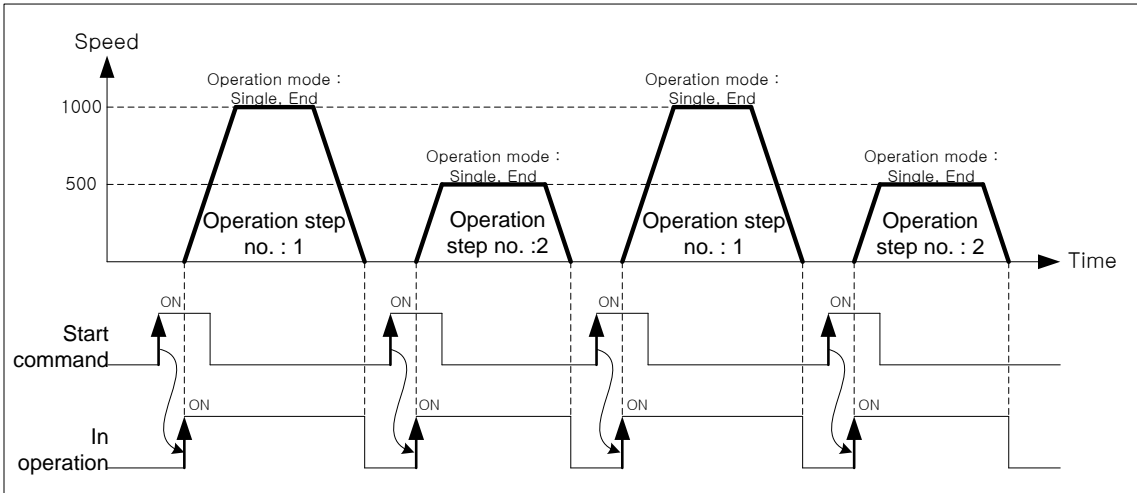

Operation step execution order according to start command will be [1] → [2] → [3] → [4].

(2) End Operation (Repeat)

- (a) With one time start command, positioning to the target position is executed and the positioning is complete after the dwell time.
- (b) The operation type of Repeat operation mode is same as that of Single operation but the different thing is that after completion of positioning, next operation is determined by operation step no. specified by Repeat Step No. Change command.
- (c) Therefore, if Repeat step no. change command was not executed, the step no.“1” will be assigned after positioning completion of Repeat operation mode and operated at next Start command. Thus, this operation can be used for the structure that several operation steps are repeated.
- (d) In case that operation step is set as the value except “0” (1~400) for Indirect Start, the positioning operation will be done with the set step no. regardless of the current operation step no. But, if the step no. is set as “0”, the positioning operation will be done with the operation step no. changed by Repeat operation mode.
- (e) Operation direction will be determined by position value.
- (f) Repeat operation step no. change command is available to execute during operation.

[Example 1] - Executes Start command after setting the step no. of “Indirect Start” as “0”
 - Execute Start command total four times.

■ Setting of XG-PM

Step NO.	Control Method	Operation Method	Target Position [pls]	Operation Speed [pls/s]	Accel NO.	Decel NO.	M Code	Dwell Time
1	Absolute Single-axis Position Control	Single, End	10000	1000	1	1	0	0
2	Absolute Single-axis Position Control	Repeat, End	15000	500	1	1	0	0
3	Absolute Single-axis Position Control	Single, End	25000	1000	1	1	0	0
4	Absolute Single-axis Position Control	Repeat, End	30000	500	1	1	0	0

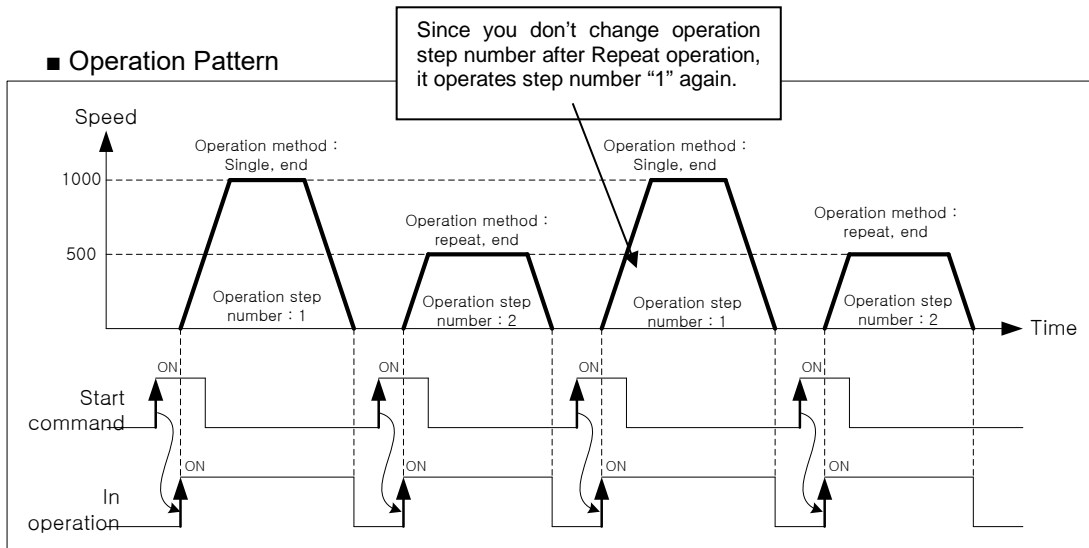

Operation step execution order according to start command will be [1] → [2] → [1] → [2].
 Operation step 3, 4 will not be executed.

[Example 2] When operating by Start command and Repeat operation step no. assignment

- Setting the step no. of indirect start as "0"
- After the first Start command, change repeat operation step number as "3" by 「Change repeat step number」 command.
- Executes Start command 3 times more.

■ Setting of XG-PM

Step NO.	Control Method	Operation Method	Goal Position [pls]	Operation Speed [pls/s]	Accel NO.	Decel NO.	M Code	Dwell Time
1	Absolute Single-axis Position Control	Single, End	10000	1000	1	1	0	0
2	Absolute Single-axis Position Control	Repeat, End	15000	500	1	1	0	0
3	Absolute Single-axis Position Control	Single, End	25000	1000	1	1	0	0
4	Absolute Single-axis Position Control	Repeat, End	30000	500	1	1	0	0

■ Operation Pattern

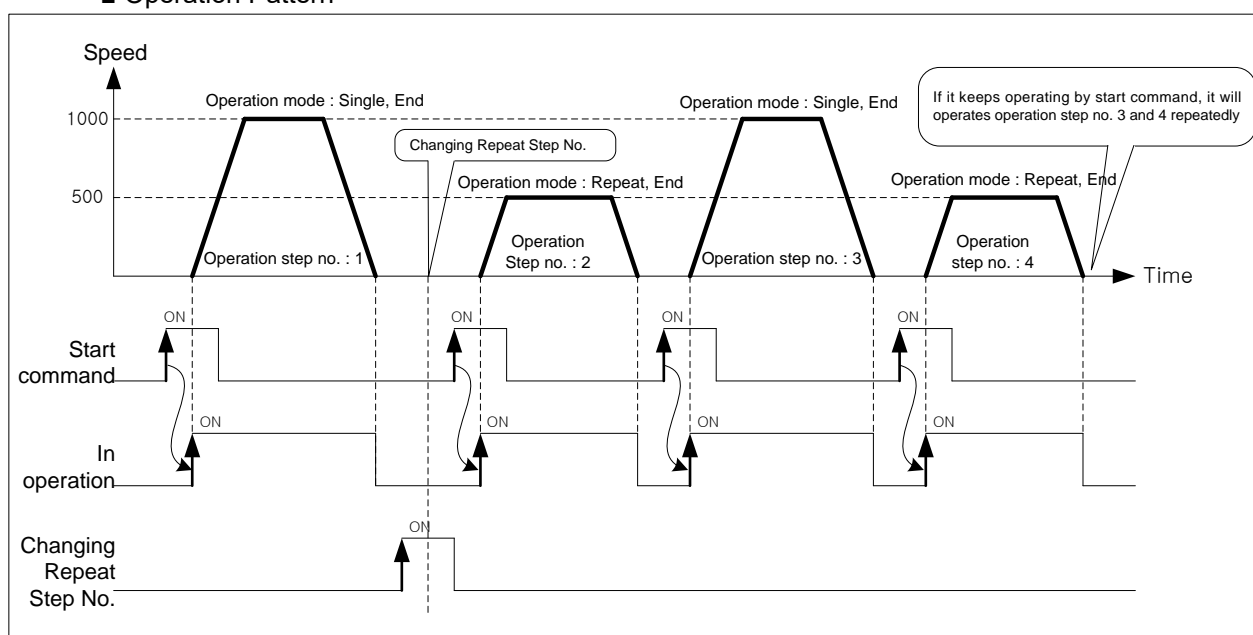

Operation step execution order according to start command will be [1] → [2] → [3] → [4].

(3) Keep Operation

- (a) With one time Start command, positioning to the target position of operation step is executed and the positioning will be completed after dwell time and without additional start command, the positioning of operation step for (current operation step no. +1) will be done.
- (b) Keep operation mode is available to execute several operation steps in order.
- (c) When using Keep operation pattern, set the operation pattern of last step as 'End'.
- (d) When operation pattern is Keep (or continuous), operation doesn't end until it executes the step whose operation pattern is 'End'. Therefore, if there is no step whose operation pattern is "End", it will keep operating until the operation step No. 400. When operation pattern of the operation step No. 400 is not the "End", error occurs and operation will be stop. When operation pattern of the operation step No. 400 is 'Keep' and 'Repeat', it will execute the operation step specified by Repeat Step No.
- (e) Operation direction will be determined by target position.

[Example] - Executes start command (Indirect Start command) after setting the step no. of "Indirect Start" as "0".

- Execute start command total four times.

■ Setting of XG-PM

Step NO.	Control Method	Operation Method	Target Position [pls]	Operation Speed [pls/s]	Accel NO.	Decel NO.	M Code	Dwell Time
1	Absolute Single-axis Position Control	Single Keep	10000	1000	1	1	0	0
2	Absolute Single-axis Position Control	Single Keep	15000	500	1	1	0	0
3	Absolute Single-axis Position Control	Single Keep	25000	1000	1	1	0	0
4	Absolute Single-axis Position Control	Single Keep	30000	500	1	1	0	0

■ Operation Pattern

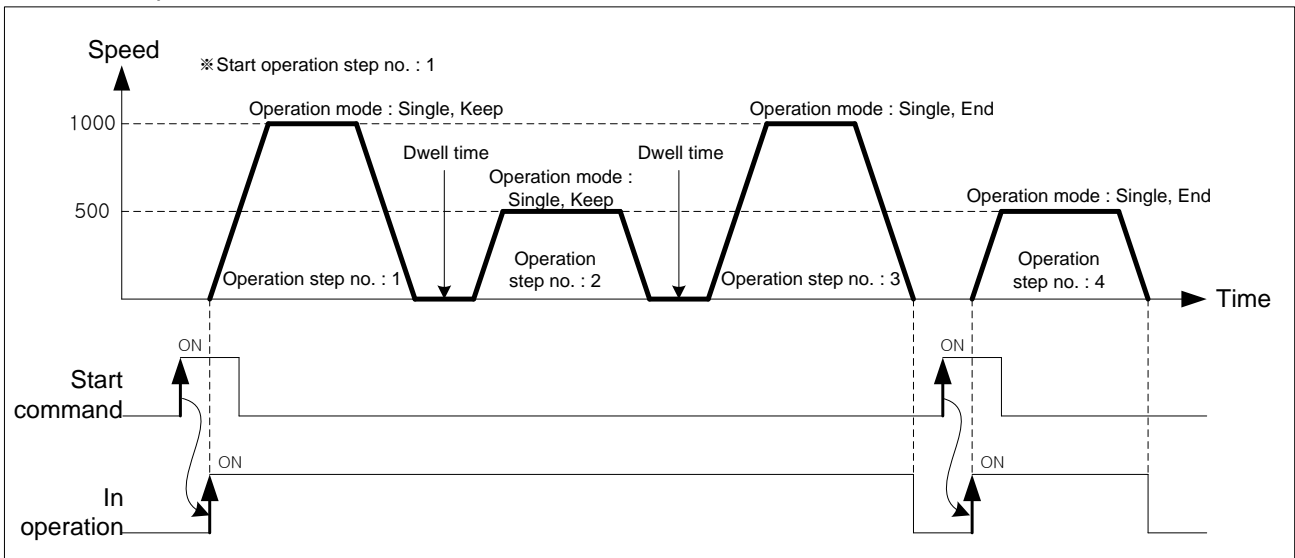

Operation step execution order according to start command will be [1] → [2] → [3] → [4].

(4) Continuous Operation

(a) Continuous Operation Overview

- 1) With one time Start command, the operation steps set as “Continuous” operation mode are executed until the target position without Dec. stop and the positioning will be completed after dwell time.
- 2) During “Continuous” operation, if the moving amount of next operation step is smaller than the distance needed to decelerate the current operation speed, “Look Ahead” control is used to avoid to stop immediately while operation speed ≠ 0
- 3) Dwell time of the operation step set as 'Continuous' operation mode is ignored, dwell time of the operation step set as 'End' operation pattern is valid.
- 4) When you execute 'Continuous' operation mode, always set the last operation step as 'End'.
- 5) When operation pattern is Continuous (or Keep), operation doesn't end until it executes the step whose operation pattern is 'End'. Therefore, if there is no step whose operation pattern is “End”, it will keep operating until the operation step No. 400. When operation pattern of the operation step No. 400 is not the “End”, error occurs and operation will be stop. When operation pattern of the operation step No. 400 is 'Continuous' and 'Repeat', it will execute the operation step specified by Repeat Step No.
- 6) Operation direction will be determined by target position.
- 7) If you want to operate the next step before the operation step that is active currently reaches the target position, it is available with 「Next Move continuous operation」 (XNMV) command.
- 8) You can execute 「Next Move continuous operation」 (XNMV) command, when the operation is in the acceleration, constant speed, deceleration section.

[Example] - Executes start command after setting the step no. of “Indirect Start” as “0”
 - Executes Start command once.

■ Setting of XG-PM

Step NO.	Control Method	Operation Method	Target Position [pls]	Operation Speed [pls/s]	Accel NO.	Decel NO.	M Code	Dwell Time
1	Absolute Single-axis Position Control	Single Continuous	10000	500	1	1	0	0
2	Absolute Single-axis Position Control	Single Continuous	30000	1000	1	1	0	0
3	Absolute Single-axis Position Control	Single End	40000	300	1	1	0	0

■ Operation Pattern

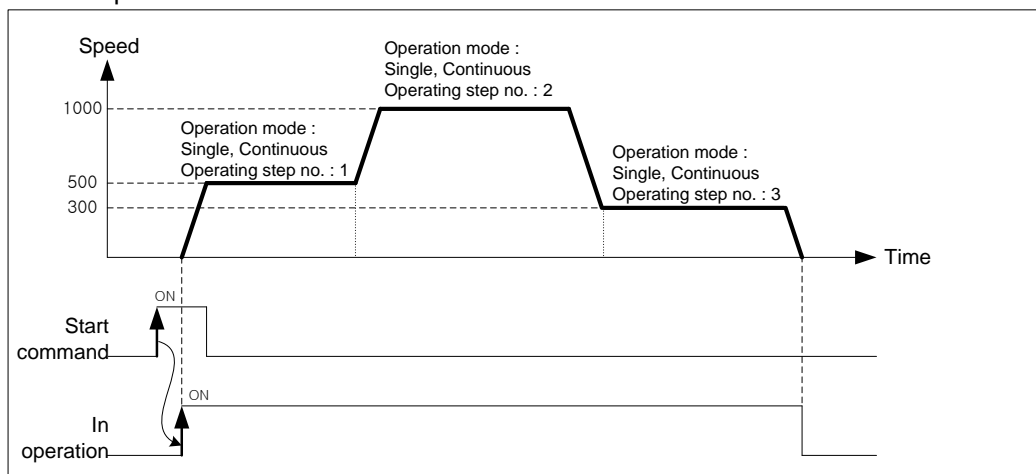

Operation step execution order according to start command will be [1] → [2] → [3].

Remark

1. When operation method is continuous, before reaching the amount of movement set by target position, sometimes its speed changes to next operation step speed. That is operating the remaining amount of movement less than operation speed at the next step to control the operation speed continuously
 (The remaining distance less than operation speed is less than distance the object can move within one control cycle (0.8 (less than 2 axes)~2.4ms (8 axes) with the speed of the object before reaching the target.
2. If control method is linear or circular interpolation and operation method is continuous, positioning speed control will be different according to "Interpolation continuous operation type" of the extended parameter. For more information, refer to "Interpolation control continuous operation".

(b) Look Ahead

- 1) During "Continuous" operation, if the moving amount of next operation step is smaller than the distance needed to decelerate the current operation speed, "Look Ahead" control is used to avoid to stop immediately while operation speed $\neq 0$
- 2) Look Ahead means is control that it calculates the permissible entry speed available for the next step by using current operation step data and target position of the next step previously and uses that as the speed of the end point of the current step. When target position (moving amount) of the next operation step is small, it makes the step speed as 0 by reducing the permissible entry speed available for the next step.
- 3) The positioning module calculate the speed of the end point using total 3 steps including current step for Look Ahead.

Next figure will explain the difference between general continuous operation using Look Ahead and not using Look Ahead.

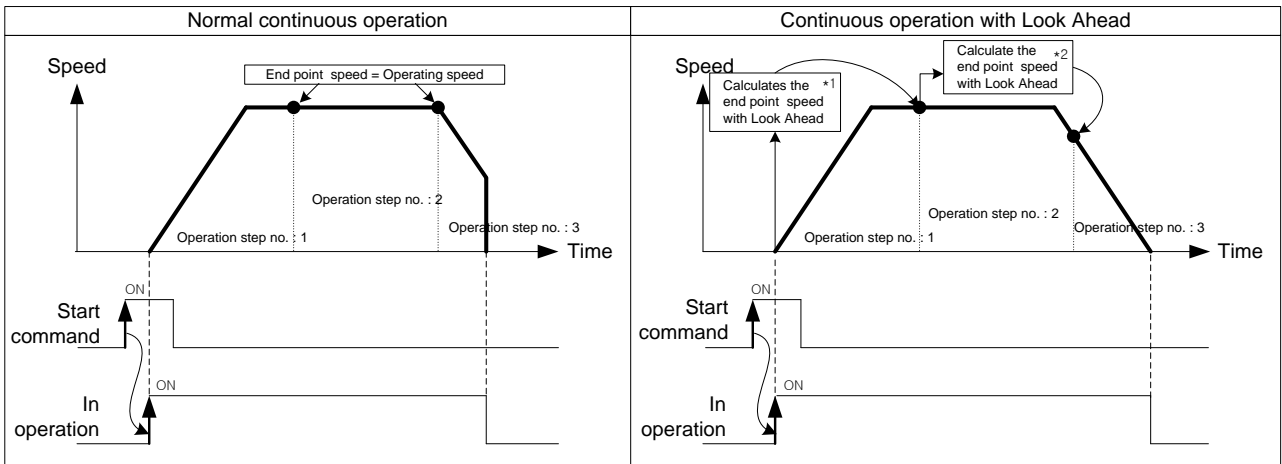

*1 : Moving amount of step 2 and step 3 is more than the distance needed to decelerate step 1 operation speed. So, endpoint speed = operation speed.

*2 : Since moving amount of step 3 is less than distance needed to decelerate step 2 operation speed, it calculates the speed that makes the stop speed of step 3 as 0 and uses that as the end point speed of step 2.

(c) Continuous operation of interpolation control

When control method is linear or circular interpolation and operation method is Continuous, positioning control is different according to "Interpolation continuous operation type" of extended parameter. There are 「Pass Target Position」 in which the object goes through the specified target position and 「Pass Near Position」 in which the object goes to the target position of the next step at the near position not exceeding the specified target position.

The next describes 「Interpolation continuous operation type」 setting of extended parameter.

Item	Setting Value	Contents
Interpolation continuous operation type	0 : Pass Target Position	In case of Continuous operation from current step to next step, the object passes the target position set on the operation data.
	1 : Pass Near Position	In case of Continuous operation from current step to next step, the object goes to the target position of next step at the near position not exceeding the target position set on the operation data.

1) Continuous Operation Passing Target Position

「Pass Target Position」 Continuous Operation means that in case of Continuous operation from current step to next step, the object passes the target position set on the operation data.

In general, when executing interpolation control passing the target position, there can be mechanical vibration because of discontinuous operating speed caused by remaining moving amount at the last section where operation data changes from current step to next step. The positioning module use the speed correction to solve mechanical vibration problem and execute Continuous operation precisely at the target position set by the user.

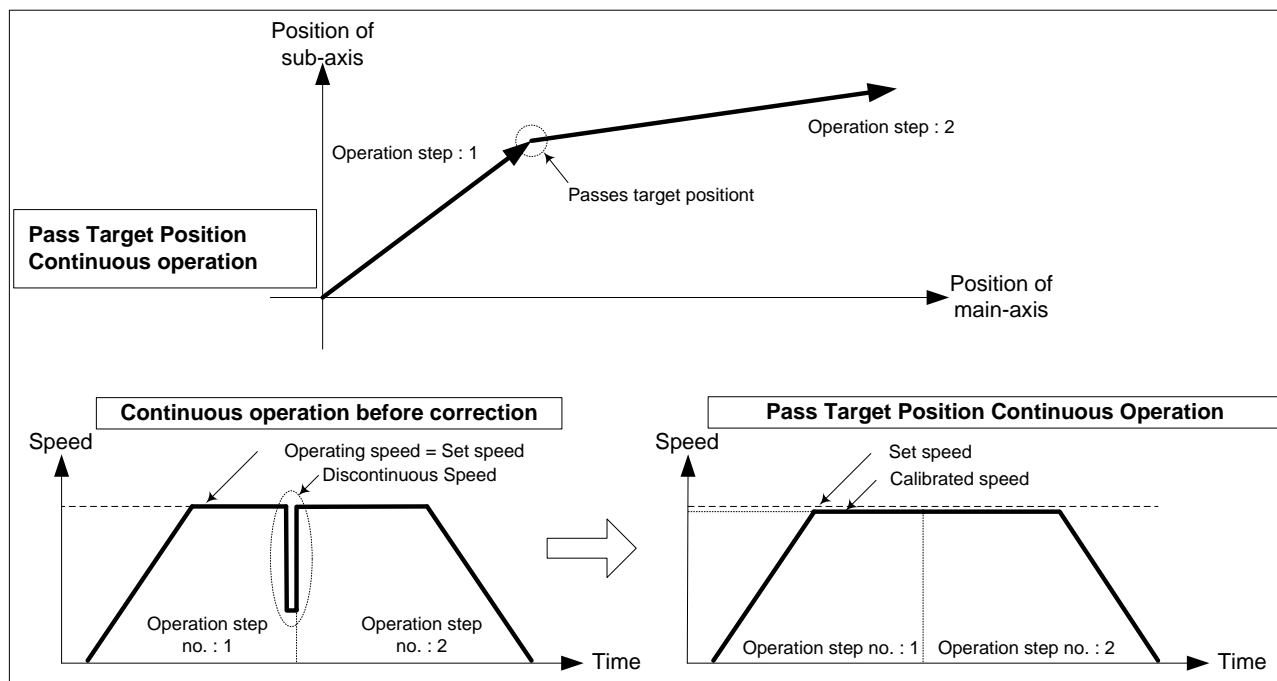

In "Pass Target Position" Continuous Operation, in order to position the object at the target position of each operation data being executed continuously, it corrects the position at the acceleration speed, constant speed section by reducing the operation speed as much as the remaining of the moving amount occurring at the last section of the current step. When operating the next step, it uses the speed corrected at the previous step as current speed. So the continuous operation is available without discontinuous operation.

2) Pass Near Position Continuous Operation

In case of continuous operation from the current step to the next step, it executes continuous operation for the target position of the next step at the near position not exceeding the target position of the current operation step. This is method to remove the discontinuity caused by remaining moving amount at the last section where operation data changes from current step to next step. The following is principal of the Pass Near Position Continuous Operation.

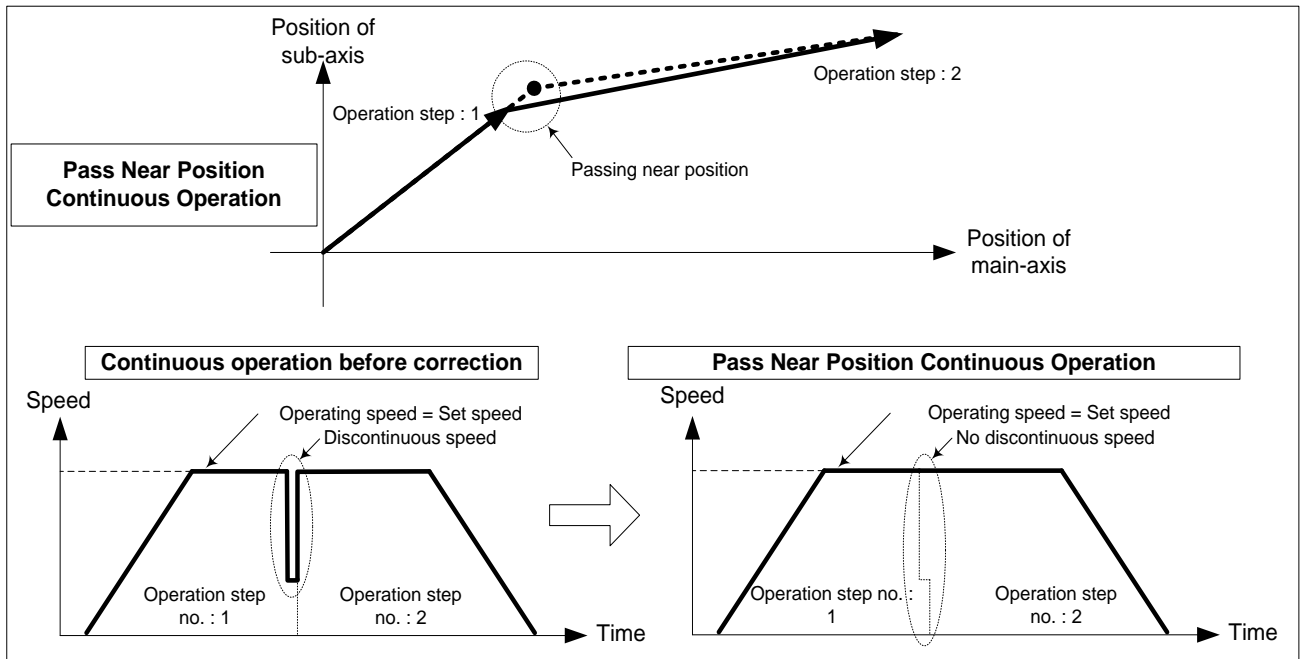

In the picture above, during general Continuous Operation, speed discontinuity occurs because of the remaining of moving amount at the last of the operation step NO.1. Since 「Pass Near Position」 Continuous Operation make it move as much as the remaining of moving amount at the next step, continuous operation without discontinuity is available.

Remark

「Pass Near Position」 continuous operation may operate with operation speed of the next step before reaching the target position according to the remaining of the moving amount based on the operation speed in order to remove the speed discontinuity. In case of single-axis position control continuous operation, if it doesn't change the direction, it always passes the target position, but in case of interpolation control continuous operation, it may operate with the operation speed of the next step before reaching the target position, then trajectory of actual movement may be different with that of operation data. The following is the Max. position gap per each axis.

$$\text{Max. position gap per each axis} < (\text{operation speed of the each axis (pls/s)} \times \text{control cycle (s)})$$

(d) Deceleration Stop of Continuous Operation

Continuous operation control decelerates and stops at the 'End' step. And then positioning is complete. However, in the following case, it keeps the next operation step after Dec. stop

1) When the moving direction of current operation step and the moving direction of next step are different (only in case of the single-axis position control)

■ Setting of XG-PM

Step NO.	Control Method	Operation Method	Target Position [pls]	Operation Speed [pls/s]	Accel NO.	Decel NO.	M Code	Dwell Time
1	Absolute Single-axis Position Control	Single Continuous	10000	1000	1	1	0	0
2	Absolute Single-axis Position Control	Single End	3000	700	1	1	0	0

■ Operation Pattern

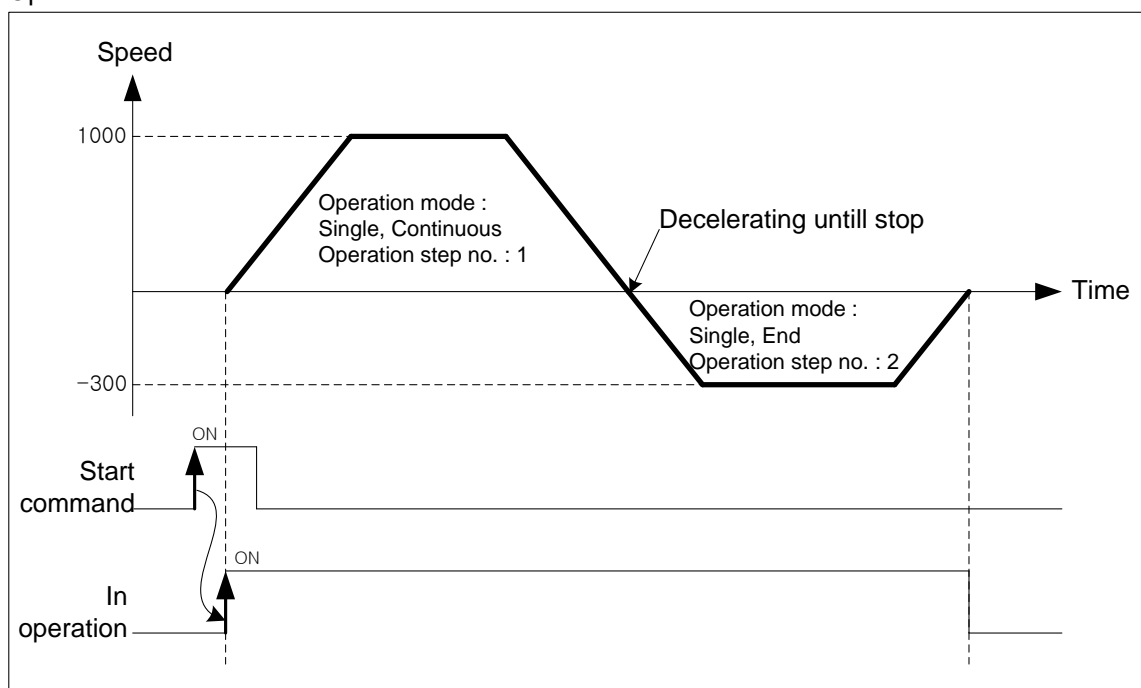

Step 1 operates by the start command and then changes moving direction because the target position of the next step goes 10000 → 3000. It decelerates and stops, and then operates Step 2 in a opposite direction.

2) When the moving amount of next step is 0

When the moving amount of next step is 0, operation speed is 0 during one cycle.

■ Setting of XG-PM

Step NO.	Control Method	Operation Method	Target Position [pls]	Operation Speed [pls/s]	Accel NO.	Decel NO.	M Code	Dwell Time
1	Absolute Single-axis Position Control	Single Continuous	10000	1000	1	1	0	0
2	Absolute Single-axis Position Control	Single Continuous	10000	700	1	1	0	0
3	Absolute Single-axis Position Control	Single End	15000	500	1	1	0	0

■ Operation Pattern

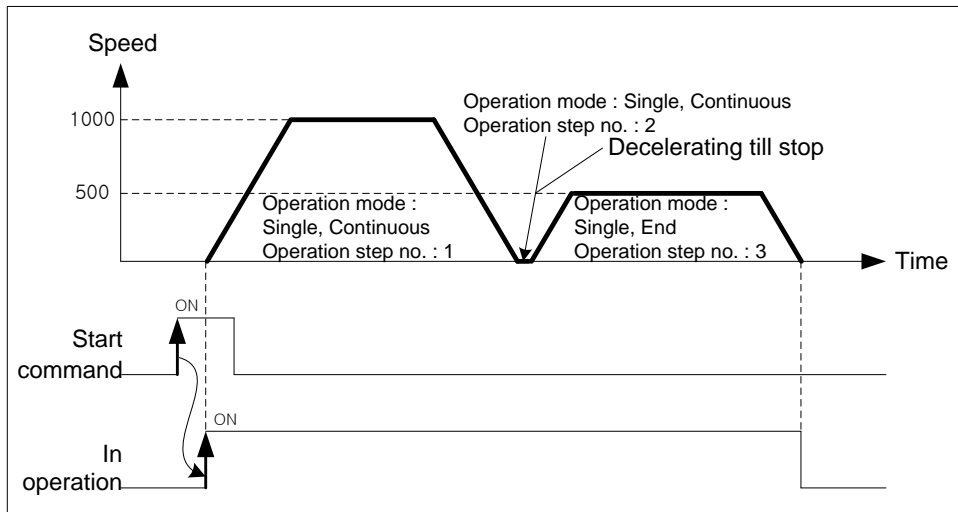

Step 1 operates by the start command, and then because target position of next step is same as that of current step, moving amount becomes 0. It decelerates and stops. And then it operates step 3.

3) When error is on the operation data of the next step

When next step of operation speed is 0, or operation method of current step is 「Single-axis Positioning Control」 and operation method of next step is 「Single-axis FEED Control」, it can not execute next operation data. In this case, it decelerates and stops at the current step. And then positioning is complete

■ Setting of XG-PM

Step NO.	Control Method	Operation Method	Target Position [pls]	Operation Speed [pls/s]	Accel NO.	Decel NO.	M Code	Dwell Time
1	Absolute Single-axis Positioning Control	Single Continuous	10000	1000	1	1	0	0
2	Absolute Single-axis Feed Control	Single Continuous	20000	1000	1	1	0	0
3	Absolute Single-axis Positioning Control	Single End	30000	1000	1	1	0	0

■ Operation Pattern

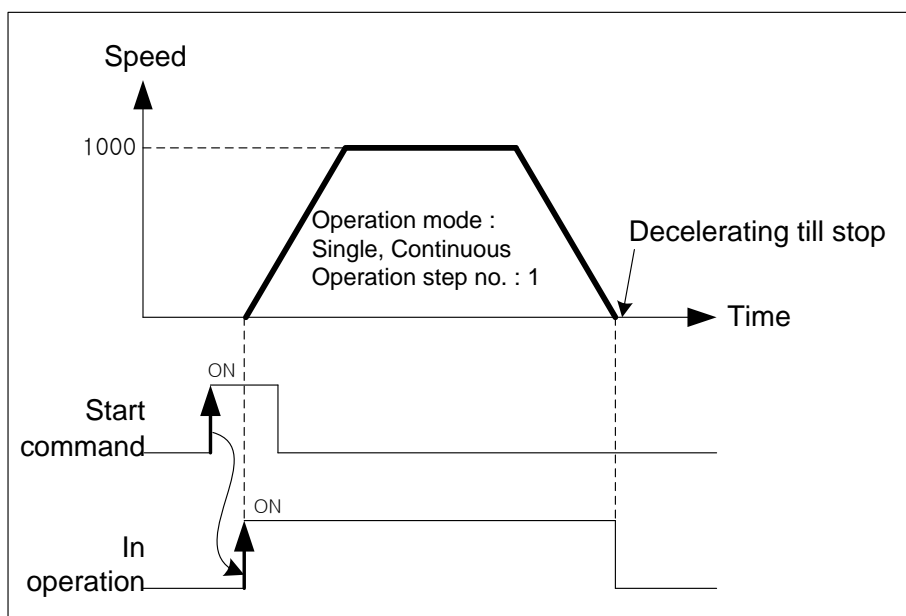

Remark

During Continuous Operation of Linear interpolation or circular interpolation, it does not check the direction of movement. So even if moving direction changes, there is no Dec. stop. Therefore, if operation data is set to change the direction, because the direction of movement changes dramatically, it may damage the machine.

In this case, use the operation method of 「Keep」 and do not use 「Continuous」, not to give the impact to the machine.

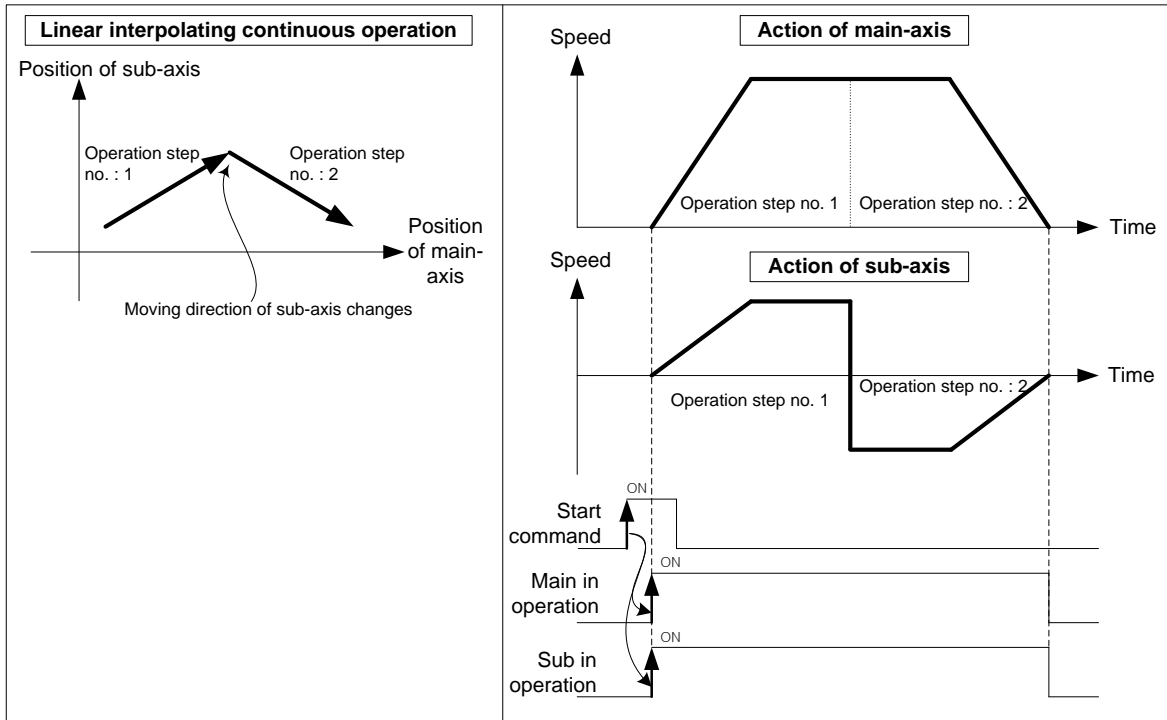

9.2.3 Single-axis Position Control

After executed by the start command (「Direct start」 , 「Indirect start」 , 「Simultaneous start」), it executes positioning control from start position (the current stop position) to target position (the position to move) on the specified axis.

- (1) Control by Absolute method (Absolute coordinate) (「Absolute, Single-axis Position Control」)
 - (a) Position control from start position to target position (assigned by positioning data). Positioning control is carried out based on the position assigned by homing (origin position).
 - (b) Moving direction is determined by start position and target position.
 - ▶ Start position < target position: forward direction positioning
 - ▶ Start position > target position: reverse direction positioning

[Example] Executes Absolute coordinate, single-axis position control with the following setting

- ▷ Start position: 1000,
 - ▷ Target position: 8000
- The moving amount to forward direction is 7000 (7000=8000-1000).

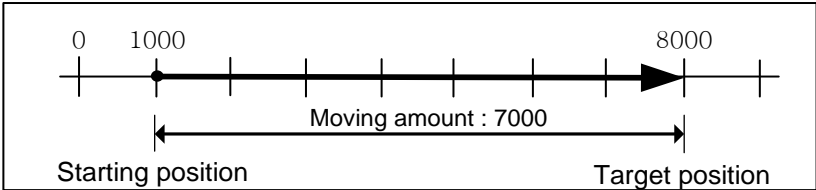

■ Setting of XG-PM

Step NO.	Control Method	Operation Method	Target Position [pls]	Operation Speed [pls/s]	Accel NO.	Decel NO.	M Code	Dwell Time
1	Absolute Single-axis Position Control	Single End	8000	1000	1	1	0	100

■ Operation Pattern

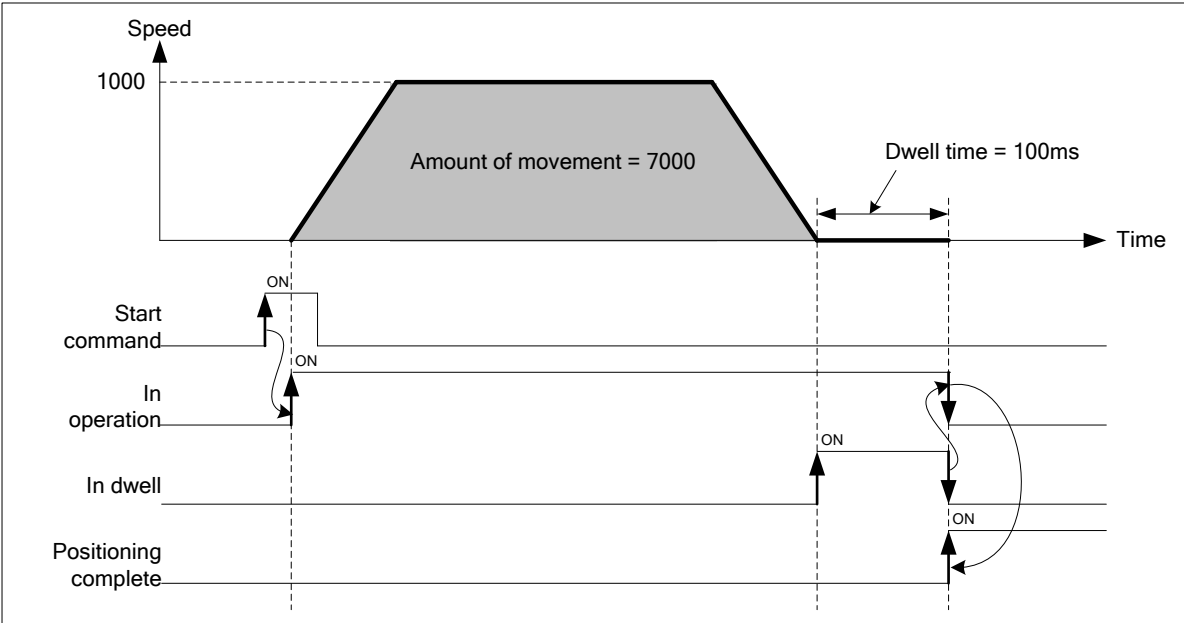

(2) Control by Incremental method (「Incremental, Single-axis Position Control」)

- (a) It moves the object as much as the target moving amount from start position. Unlike the target position of the absolute coordinate, the value specified on target position is not position value. That is a transfer amount from the current position.
- (b) Transfer direction is determined by the sign of moving amount.
 - ▷ Transfer direction (+) or no sign: forward direction positioning (current position increases)
 - ▷ Transfer direction (-) : reverse direction positioning (current position decreases)

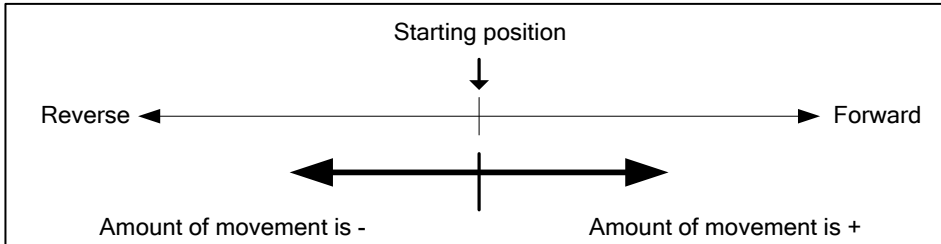

[Example] Executes Absolute coordinate, single-axis position control with the following setting

- ▷ Start position: 5000,
- ▷ Target position: -7000

It goes to reverse direction and stops at the -2000.

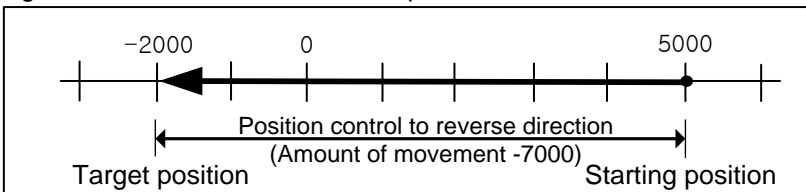

■ Setting of XG-PM

Step NO.	Control Method	Operation Method	Target Position [pls]	Operation Speed [pls/s]	Accel NO.	Decel NO.	M Code	Dwell Time
1	Absolute Single-axis Position Control	Single End	-7000	1000	1	1	0	100

■ Operation Patten

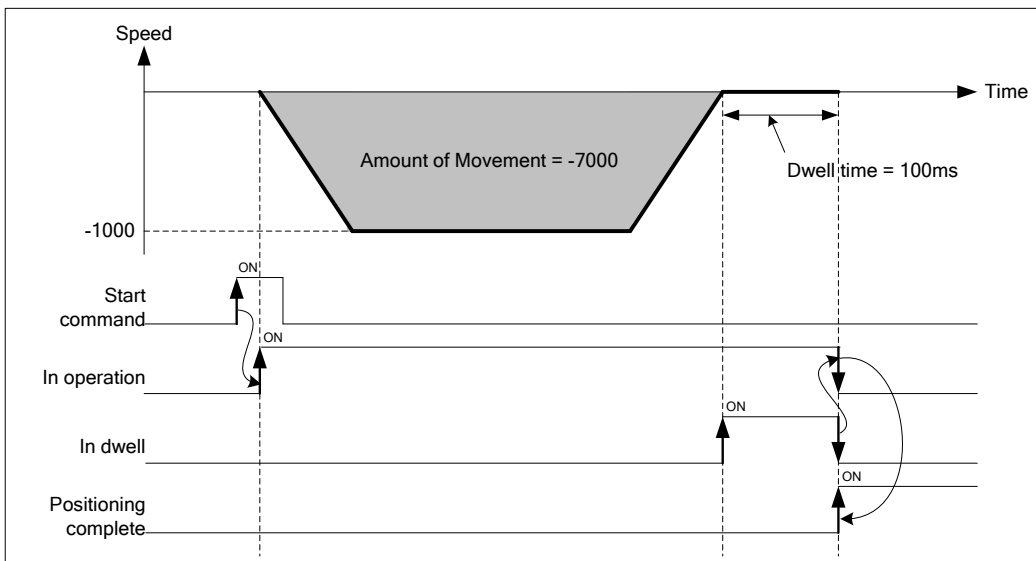

9.2.4 Single-axis Speed Control

After executed by the start command (「Direct start」, 「Indirect start」, 「Simultaneous start」), it keeps moving with the specified speed until deceleration stop command is entered.

(1) Features of Control

- (a) Speed control contains 2 types of start: Forward direction start and Reverse direction start.
 - ▷ Forward direction: when position value is positive number (+) ("0" included)
 - ▷ Reverse direction: when position value is negative number (-)
- (b) In case of using speed control, the following items of operation data do not affect.
 - ▷ Coordinate, Operation method, Dwell time
 - ▷ "Absolute, single-axis speed control" and "Incremental, single-axis speed control" execute same operation.
- (c) Accelerating operation of speed control operates based on acceleration number on operation data, decelerating operation operates based on deceleration time of a command 「deceleration stop」.

(2) Operation Timing

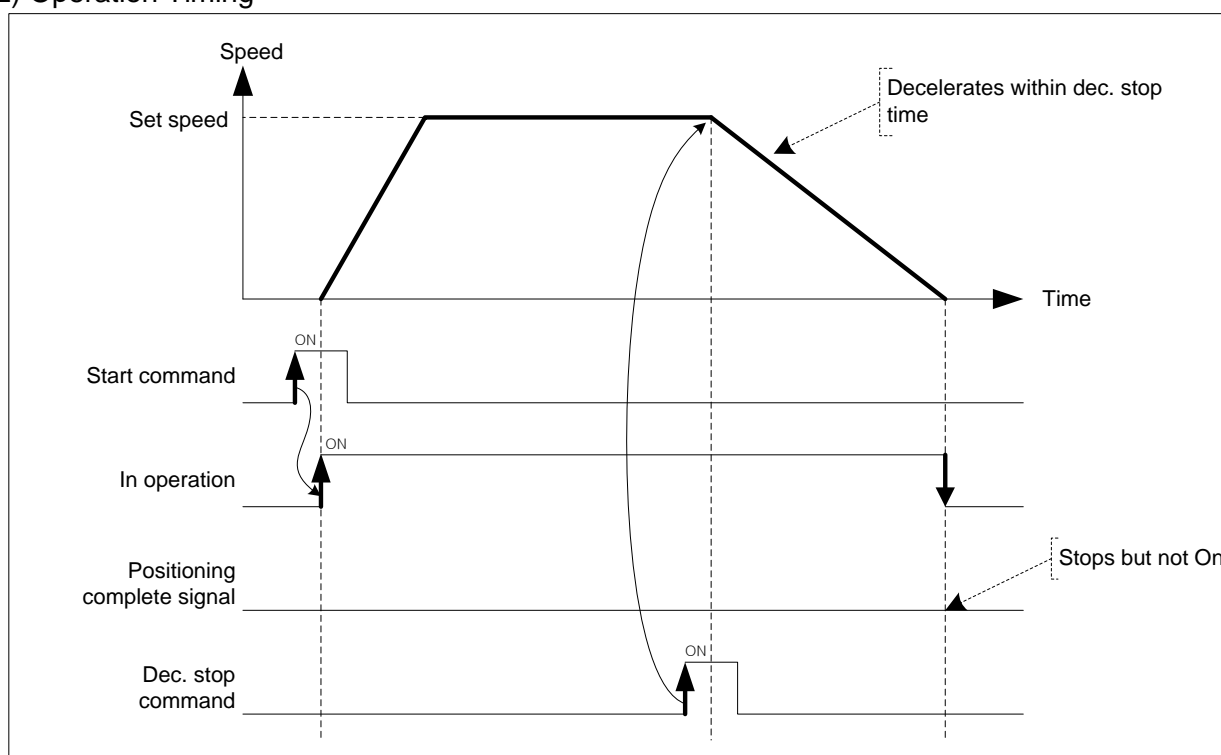

(3) Restrictions

- (a) Set the operation pattern of speed control as 'End' or 'Keep'. When it is set as "Continuous", error occurs (error code: 236) and can not execute speed control.
- (b) In speed control, only when 「M code mode」 of extended parameter is "with", M code signal is "On".
(If you use "After mode", M code signal will not be "On".)
- (c) For a software upper/lower limit check during speed control, it varies according to the setting of the "Software limit detect".

Item	Setting Value	Contents
Soft Upper/Lower Limit detect during speed control	0 : Don't Detect	During Speed Control, do not operate to check the range of upper/lower limit of software
	1 : Detect	During Speed Control, operate to check the range of upper/lower limit of software

(4) Setting of XG-PM

Step NO.	Control Method	Operation Method	Target Position [pls]	Operation Speed [pls/s]	Accel NO.	Decel NO.	M Code	Dwell Time
1	Absolute Single-axis Speed Control	Single End	100	1000	1	1	0	0

9.2.5 Single-axis Feed Control

After executed by the start command (「Direct start」, 「Indirect start」, 「Simultaneous start」), it changes current stop position as '0' and operates until target position.

(1) Features of control

(a) The value set on target position is moving amount. That is, moving direction is decided by the sign of target position.

- ▷ Forward direction : when position address is positive number (+) ("0" included)
- ▷ Reverse direction : when position address is negative number (-)

(b) In case of using Single-axis Feed Control, the following items of operation data do not affect.

- ▷ Coordinate
- ▷ "Absolute, single-axis speed control" and "Incremental, single-axis speed control" execute same operation.

(2) Operation Timing

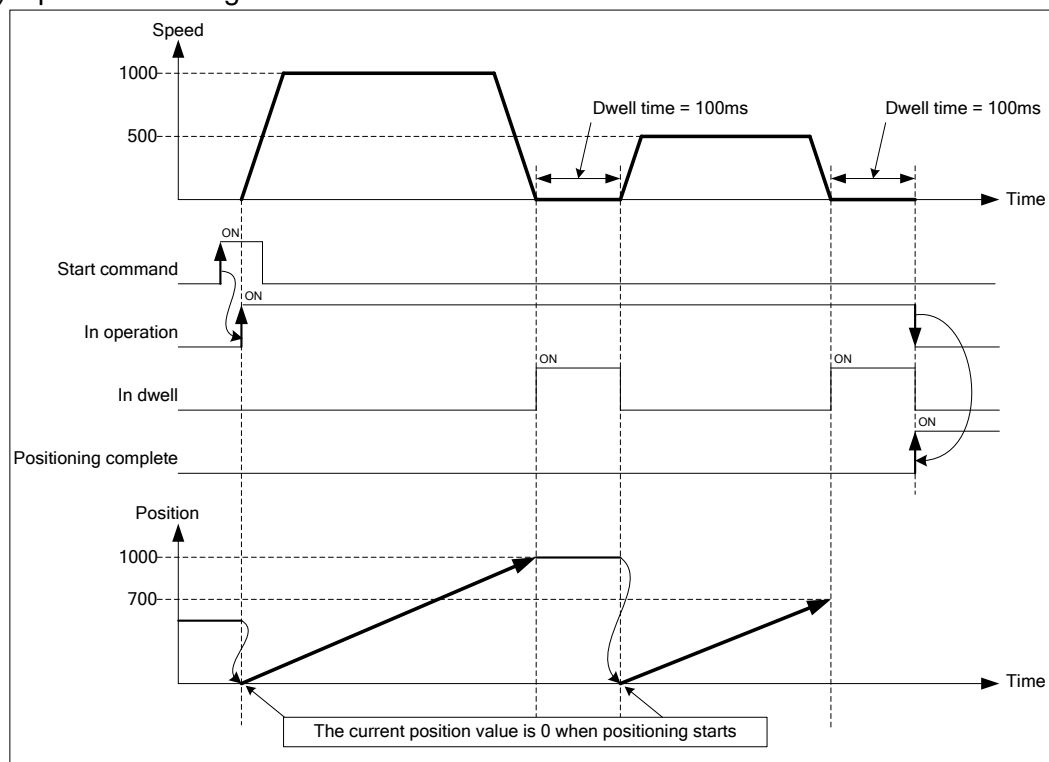

(3) Restrictions

(a) Set the operation pattern of Feed control as 'End' or 'Keep'. When it is set as "Continuous", error occurs (error code: 230) and can not execute Feed control.

(4) Setting of XG-PM

Step NO.	Control Method	Operation Method	Goal Position [pls]	Operation Speed [pls/s]	Accel NO.	Decel NO.	M Code	Dwell Time
1	Absolute, Single-axis Feed Control	Single, Keep	1000	1000	1	1	0	100
2	Absolute, Single-axis Feed Control	Single End	700	500	1	1	0	100

9.2.6 Linear Interpolation Control with 2 axes

After executed by start command (「Indirect start」 , 「Synchronous start」), then executes interpolation control from starting position to the target position with linear trajectory by using the interpolation axes set as the main axis and sub axis.

(1) Linear interpolation control with absolute coordinates (「Absolute, Linear Interpolation」)

- (a) Executes linear interpolation from starting position to the target position designated on positioning data. Positioning control is carried out based on the position specified from homing.
- (b) The direction of movement depends on the starting position and the target position for each axis.
 - Starting position < target position: Positioning operation in forward
 - Starting position > target position: Positioning operation in reverse

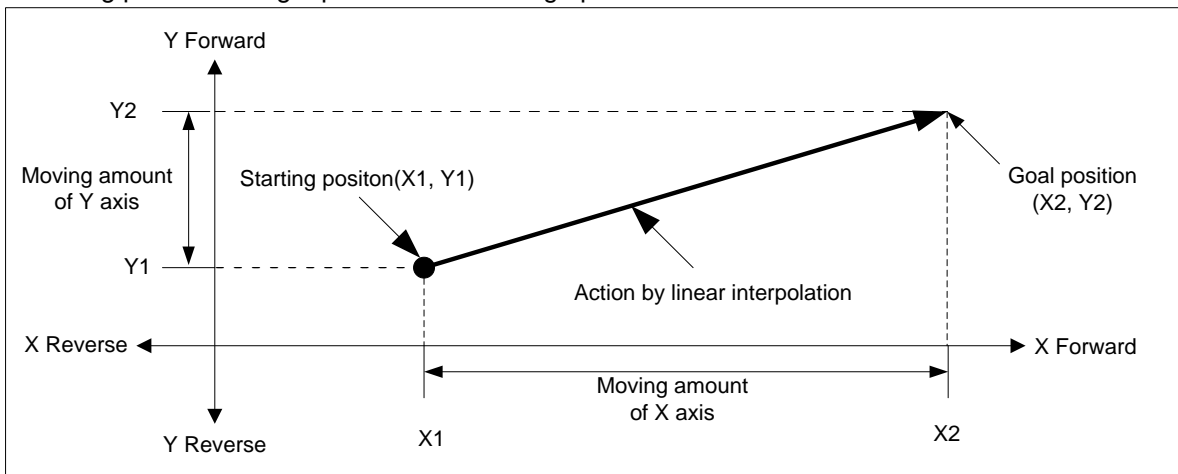

(c) Restrictions

Linear interpolation with 2 axes may not be executed in the case below.

- 「Sub axis setting」 Error (error code : 253)
 - 「Sub axis setting」 of operation data of the main axis is "Axis-undecided"
 - 「Sub axis setting」 of operating data of the main axis is the same as main axis no.
 - 「Sub axis setting」 of operating data of the main axis exceeds the settable axis no.

Remark

Because more than 2 axes are in action, so need user to pay attention

- (1) The commands available are as follows.
 - Speed override, Dec. stop, Emg. stop, Skip operation, Continuous operation
- (2) The commands unavailable in linear interpolation are as follows.
 - Position/Speed switching control, Position override
- (3) The parameter items which work depending on the value of each axis are as follows.
 - Software high/low limit among extended parameter items

(d) Setting example of operation data

Setting items	Main-axis setting	Sub-axis setting	Description
Control method	Absolute, Linear interpolation	Absolute, single axis position control	When linear interpolation control is executed by the absolute coordinates method, set 「Absolute, Linear interpolation」 on the main axis and set the sub-axis coordinate as “Absolute”.
Operating method	Single, End	- ^{*1}	Set the operating method to execute linear interpolation
Target position [pls]	10000	5000	Set the target position on main-axis and sub-axis
Operation speed [pls/s]	1000	-	Speed of interpolation operation is determined by main axis speed. Set the main axis speed.
Acc. no.	No.1	-	Set acc. no. for acceleration (no.1 ~ no.4)
Dec. no.	No.2	-	Set dec. no. for deceleration. (no.1 ~ no.4)
M code	0	-	When you need to execute auxiliary work based on the interpolation operation, set the M code
Dwell time	500	-	Set dwell time(ms) needed to output the positioning completion signal
Sub-axis setting	Axis2	-	Set an axis to be used as sub-axis among settable axis in operating data of main-axis

-^{*1} : It does not need to be set. Whatever value is set, it does not affect the linear interpolation.

Remark

Linear interpolation control is executed on the basis of operating data of main axis.

Only 「Target position」 item of sub-axis setting affects linear interpolation. In other word, whatever value is set for other items, it does not affect the operation and errors do not arise.

But, coordinate setting of sub-axis control method indicates whether target position is absolute coordinate value or incremental coordinate value. So in case of linear interpolation control by absolute coordinate method, set the coordinate of sub-axis as “Absolute”.

[Example] axis1 and axis2 are main and sub axis each. Executes linear interpolation with the following setting

- Starting position (1000, 4000), target position (10000, 1000)

In this condition, the operation is as follows.

- Setting example of XG-PM

- Operation data of main-axis(1-axis)

Step no.	Control method	Operating method	Target position [pls]	Operating speed [pls/s]	Acc. no.	Dec. no.	M code	Dwell time	Sub axis setting
1	Absolute, Linear	Singular, End	10000	3000	No.1	No.1	0	100	Axis2

- Operation data of sub-axis(2-axis)

Step no.	Control method	Operation method	Target position [pls]	Operating speed [pls/s]	Acc. no.	Dec. no.	M code	Dwell time	Sub axis setting
1	Absolute, Single-axis position control	Single, End	1000	0	No.1	No.1	0	0	Axis-undecided

- Operating pattern

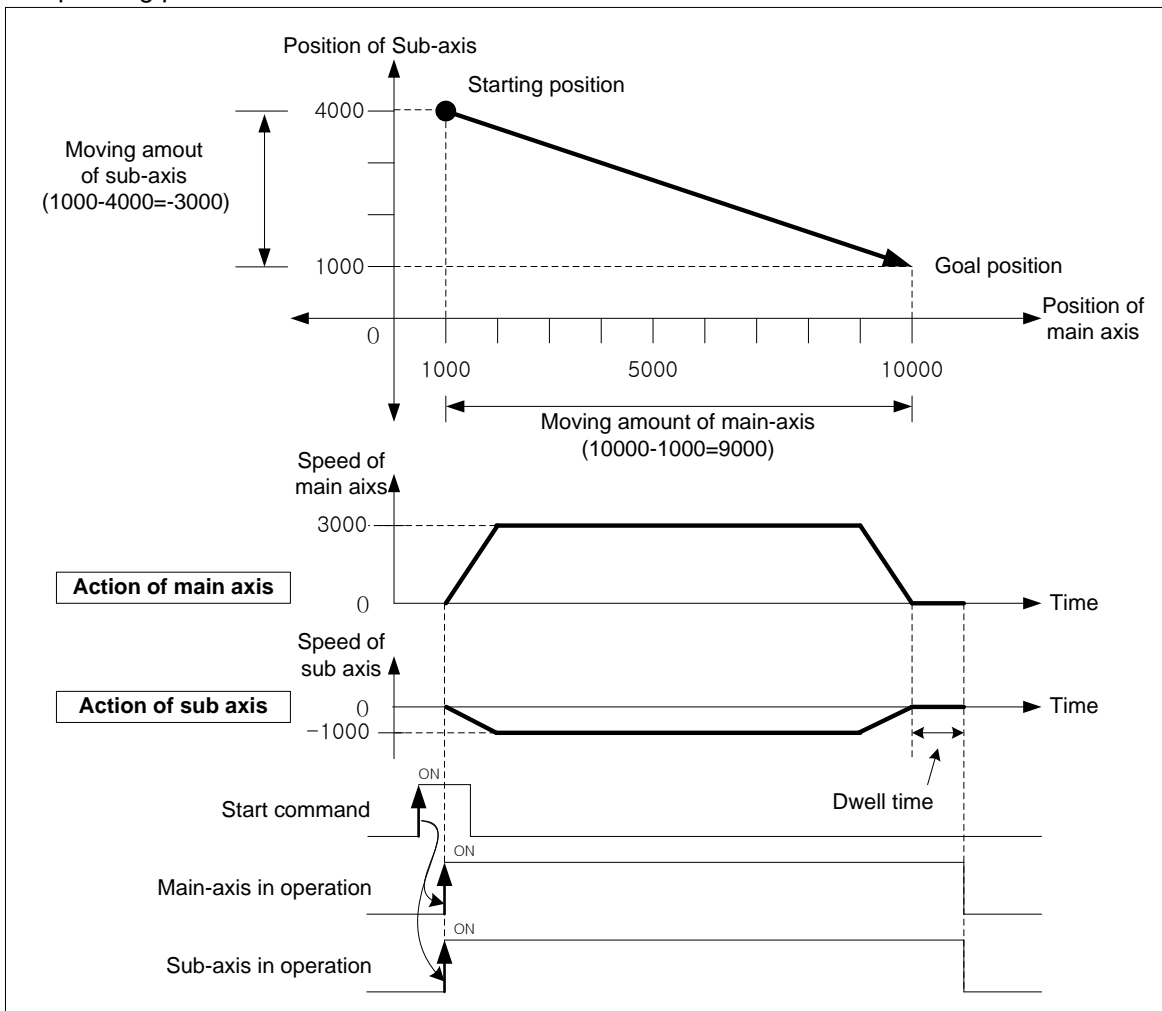

(2) Linear interpolation control with incremental coordinates (「Incremental, Linear Interpolation」)

(a) Executes 2 axes linear interpolation from starting position to the target position. Positioning control is carried out based on the current stop position.

(b) Moving direction depends on the sign of the target position (Moving amount)

- The sign is positive (+ or nothing) : Positioning operation in forward
- The sign is negative (-) : Positioning operation in reverse

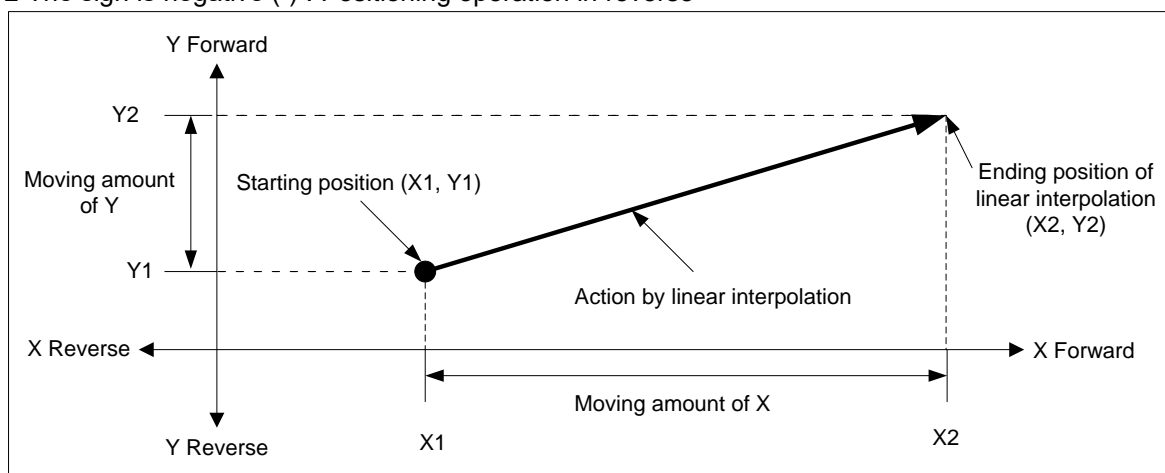

(c) Restrictions

Linear interpolation with 2 axes may not be executed in the case below.

- 「Sub-axis setting」 error (error code : 253)
 - 「Sub-axis setting」 value of operation data of the main axis is "Axis-undecided"
 - 「Sub-axis setting」 value of operation data of the main axis is same as the main axis no.
 - 「Sub-axis setting」 value of operation data of the main axis exceeds settable axis no.

(d) Setting example of operation data

Setting items	Main-axis setting	Sub-axis setting	Description
Control method	Incremental, Linear interpolation	Incremental, single-axis position control	When linear interpolation control is executed by the incremental coordinate method, set 「Incremental, Linear interpolation」 on the main axis and set the sub-axis as “Incremental” coordinate.
Operating method	Single, End	- ^{*1}	Set the operation method to execute linear interpolation
Target position [pls]	10000	5000	Set the moving amount on the main & sub-axis
Operation speed [pls/s]	1000	-	Speed of interpolation operation is determined by main axis speed. Sets the main axis speed.
Acc. no.	No.1	-	Set acc. no. for acceleration (no.1 ~ no.4)
Dec. no.	No.2	-	Set dec. no. for deceleration. (no.1 ~ no.4)
M code	0	-	When you need to execute auxiliary work based on the interpolation operation, set the M code
Dwell time	500	-	Set dwell time(ms) needed to output the positioning completion signal
Sub-axis setting	Axis2	-	Set an axis to be used as sub-axis among settable axis in operating data of main-axis

-^{*1} : It does not need to be set. Whatever value is set, it does not affect linear interpolation.

Remark

Linear interpolation control is executed on the basis of operation data of main axis.
 Only 「Target position」 item of sub-axis setting affect linear interpolation. In other word, whatever value is set for other items, it does not affect the operation and errors do not arise.
 But, coordinate setting of sub-axis control method indicates whether target position is absolute coordinate value or incremental coordinate value. So in case of linear interpolation control by incremental coordinate method, set the coordinate of sub-axis as “Incremental”.

[Example] axis1 and axis2 are main and sub axis each. Executes linear interpolation with the following setting

- Starting position (1000, 4000), Target position (9000, -3000)
In this case, the operation is as follows.
- Setting example of XG-PM
 - Operation data of main-axis(axis1)

Step no.	Control method	Operation method	Target position [pls]	Operation speed [pls/s]	Acc. no.	Dec. no.	M code	Dwell time	Sub axis setting
1	Incremental, Linear	Single, End	9000	3000	No.1	No.1	0	100	Axis2

▪ Operation data of sub-axis(axis2)

Step no.	Control method	Operation method	Target position [pls]	Operation speed [pls/s]	Acc. no.	Dec. no.	M code	Dwell time	Sub axis setting
1	Incremental, Single axis position control	Single, End	-3000	0	No.1	No.1	0	0	Axis-undecided

■ Operating pattern

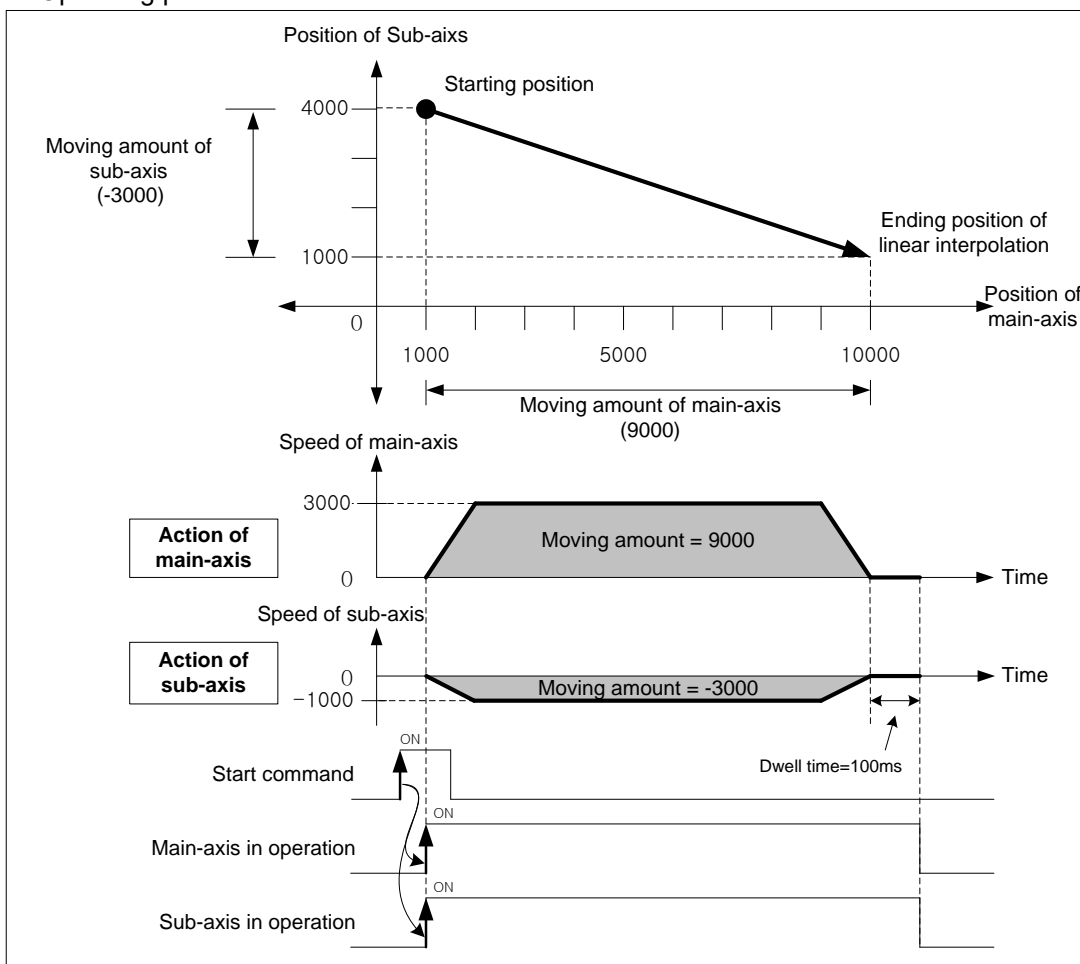

(3) Speed in 2 axes linear interpolation control

Operation speed in linear interpolation is determined based on “Interpolation speed selection” option of extended parameter, main-axis speed or synthetic speed. If operation speed is set on command axis (main), positioning module calculates the speed of sub-axis based on the moving amount. Sub-axis speed and interpolation speed of the object are calculated as follows.

■ Speed in 2 axes linear interpolation (when main-axis speed is selected)

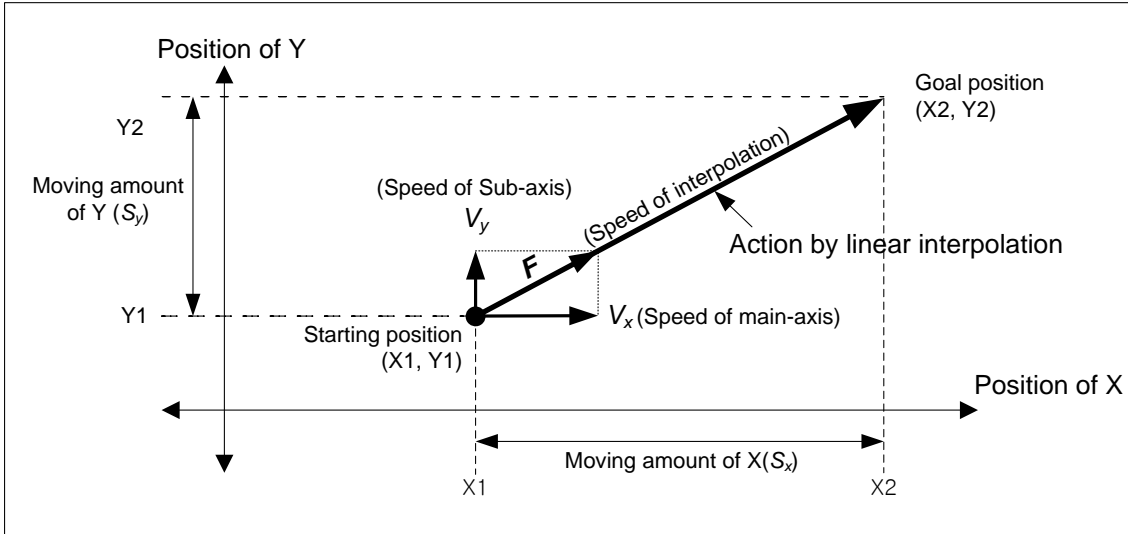

$$\text{Speed of sub}(V_y) = \text{Speed of main}(V_x) \times \frac{\text{Moving amount of Sub}(S_y)}{\text{Moving amount of Main}(S_x)}$$

$$\text{Interpolating speed}(F) = \sqrt{V_x^2 + V_y^2}$$

[Example]

- Starting position (2000, 1000)
 - Target position (6000, 4000)
 - Operating speed : 400 [pls/s]
- Sub-axis speed and interpolating speed are as follows.

$$\text{Speed of sub-axis} = 400 \times \frac{3000}{4000} = 300 \text{ [pls/s]}$$

$$\text{Interpolating speed} = \sqrt{400^2 + 300^2} = 500 \text{ [pls/s]}$$

■ Speed in 2 axes linear interpolation (when synthetic speed is selected)

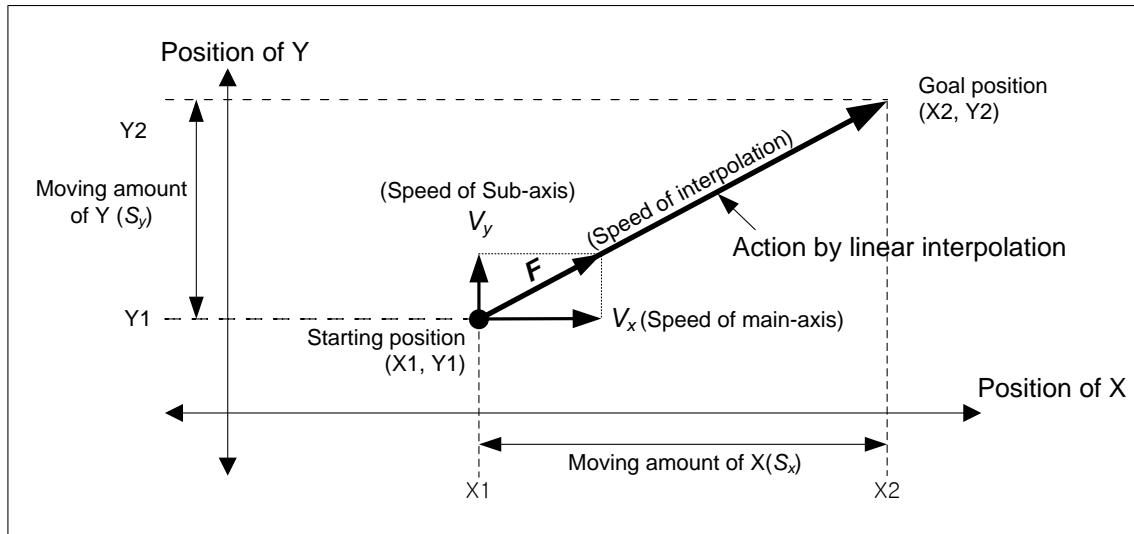

Interpolating speed (F) = Operations speed set in position data

$$\text{Interpolating moving amount (S)} = \sqrt{S_x^2 + S_y^2}$$

$$\text{Main axis speed (V}_x\text{)} = \text{interpolating speed (F)} \times \frac{\text{Main axis moving amount (S}_x\text{)}}{\text{Interpolating moving amount (S)}}$$

$$\text{Sub axis speed (V}_y\text{)} = \text{Interpolating speed (F)} \times \frac{\text{Main axis moving amount (S}_y\text{)}}{\text{Interpolating moving amount (S)}}$$

[Example]

- Starting position (2000, 1000),
- Target position (6000, 4000)
- Synthetic speed: 400 [pls/s]

Main-axis speed and sub-axis speed are as follows.

$$\text{Interpolating moving amount} = \sqrt{4000^2 + 3000^2} = 5000$$

$$\text{Main-axis speed} = 400 \times \frac{4000}{5000} = 320 \text{ [pls/s]}$$

$$\text{Sub-axis speed} = 400 \times \frac{3000}{5000} = 240 \text{ [pls/s]}$$

Remark

(1) Speed limit for Sub-axis when interpolation speed is main axis speed
 When using linear interpolation control and moving distance of main < moving distance of sub, it is possible that sub-axis speed calculated by positioning module exceeds 「Speed limit」 of basic parameter. In this case, error (error code: 261) arises and main-axis speed is recalculated for sub-axis not to exceed “Speed Limit” and operates. To prevent errors, reduce the main-axis speed so that sub-axis speed doesn’t exceed the “Speed Limit”.

(2) The speed when the moving distance of main-axis is 0 and interpolation speed is main axis speed
 When the moving distance of main-axis is 0, the operation speed of main-axis operation data becomes actual interpolating speed. In this case of 2 axes linear interpolation where the moving distance of main-axis is 0, only sub-axis operates at the speed set on command axis.

■ Setting example of XG-PM

▪ Operating data of Main-axis

Step no.	Control method	Operation method	Target position [pls]	Operation speed [pls/s]	Acc. no.	Dec. no.	M code	Dwell time	Sub axis setting
1	Absolute, Linear interpolation	Single, Continuous	5000	1000	No.1	No.1	0	100	Axis2
2	Absolute, Linear interpolation	Single, End	5000	1000	No.1	No.1	0	100	Axis2

▪ Operating data of Sub-axis

Step no.	Control method	Operating method	Target position [pls]	Operation speed [pls/s]	Acc. no.	Dec. no.	M code	Dwell time	Sub axis setting
1	Absolute, single axis position control	Single, End	1000	0	No.1	No.1	0	0	Axis-undecided
2	Absolute, single axis position control	Single, End	3000	0	No.1	No.1	0	0	Axis-undecided

■ Operating pattern

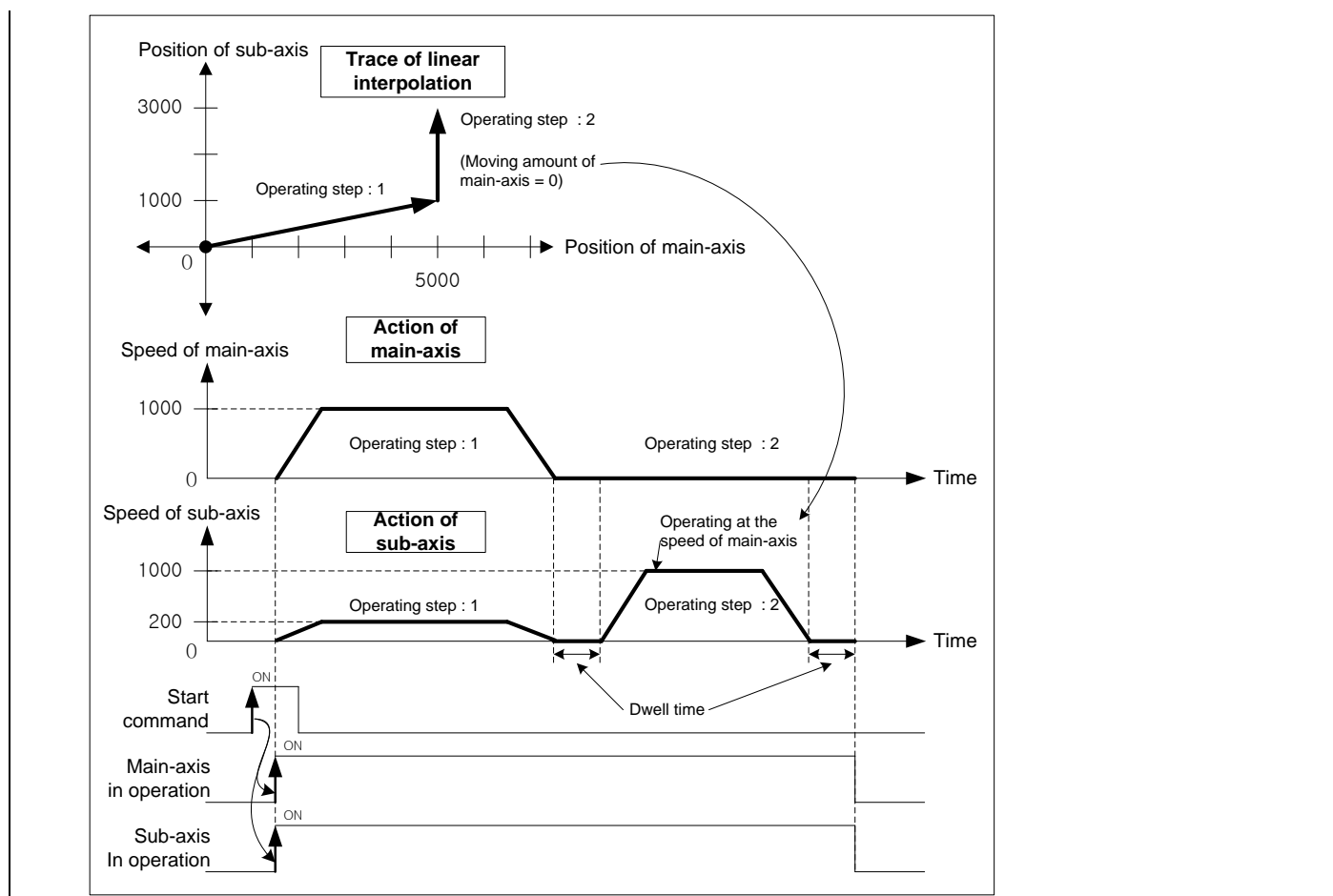

(4) 2 axes linear interpolation continuous operation with circular arc insertion

When the operation method is set as “continuous” and the direction of movement changes rapidly, machine is possible to be damaged. When you need not position the object to the target position precisely, user can insert ‘circular interpolation operation’ between two trajectories to make operation softer and smoother.

(a) Operation order

1) Confirm whether to execute 2 axes linear interpolation continuous operation with circular arc insertion. It can be set in 「Arc insertion」 of extended parameter.

Setting items	Setting value	Description
Arc insertion	0 : Don't insert	In case of 2 axes linear interpolation continuous operation, it doesn't insert arc
	1 : Insert arc cont.	In case of 2 axes linear interpolation continuous operation, it inserts arc

2) It checks the position where arc will be inserted and resets the starting position of circular interpolation (target position of linear trajectory 1) and the target position (starting position of linear trajectory 1). The position where circular arc will be inserted can be set in 「Arc insertion position」 of extended parameter.

Setting items	Setting value	Description
Arc insertion position	0 ~ 2147483647	Set the position where circular arc will be inserted. This value means the incremental distance from the target position of linear trajectory 1.

3) After linear interpolation to the starting position of circular arc to be inserted, it executes circular interpolation

at the same speed as linear interpolation. After finishing the circular interpolation, it executes linear interpolation to the target position of the next operation step again at the same speed.

(b) Operating pattern

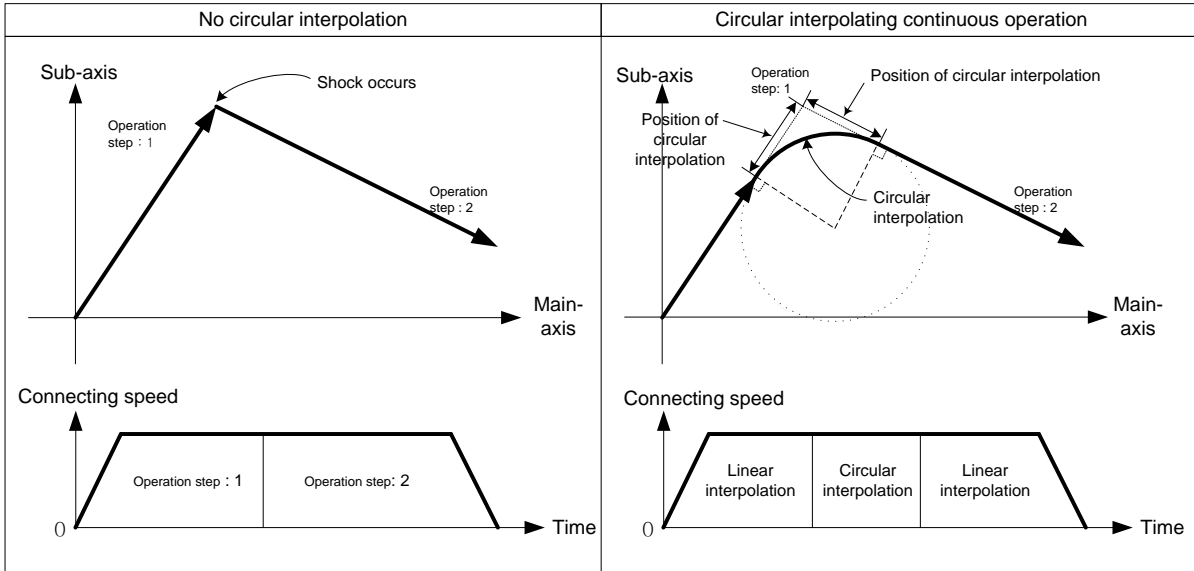

(c) Restrictions

Circular arc is not inserted in the case below and it executes linear interpolation to the target position.

- Operating method of operation data is “End” or “Keep”
- Position of circular arc insertion is bigger than linear trajectory 1, 2 (Error code : 262)
- Trajectory of both linear interpolations are on the same line

[Example] Executes linear interpolation at the current position (0,0) when the extended parameter setting is as follows

Extended parameter	Setting value
Arc insertion	1 : Insert arc cont.
Arc insertion position	2000

■ Setting example of XG-PM

▪ Operating data of Main-axis

Step no.	Control method	Operating method	target position [pls]	Operating speed [pls/s]	Acc. no.	Dec. no.	M code	Dwell time	Sub axis setting
1	Absolute, Linear interpolation	single, continuous	0	3000	No.1	No.1	0	0	Axis2
2	Absolute, Linear interpolation	single, continuous	5000	3000	No.1	No.1	0	0	Axis2
3	Absolute, Linear interpolation	single, end	5000	3000	No.1	No.1	0	100	Axis2

▪ Operating data of Sub-axis

Step no.	Control method	Operating method	Target position [pls]	Operating speed [pls/s]	Acc. no.	Dec. no.	M code	Dwell time	Sub axis setting
1	Absolute, single axis position control	single, end	1000	0	No.1	No.1	0	0	Axis-undecided
2	Absolute, single axis position control	single, end	1000	0	No.1	No.1	0	0	Axis-undecided
3	Absolute, single axis position control	single, end	4000	0	No.1	No.1	0	0	Axis-undecided

■ Operating pattern

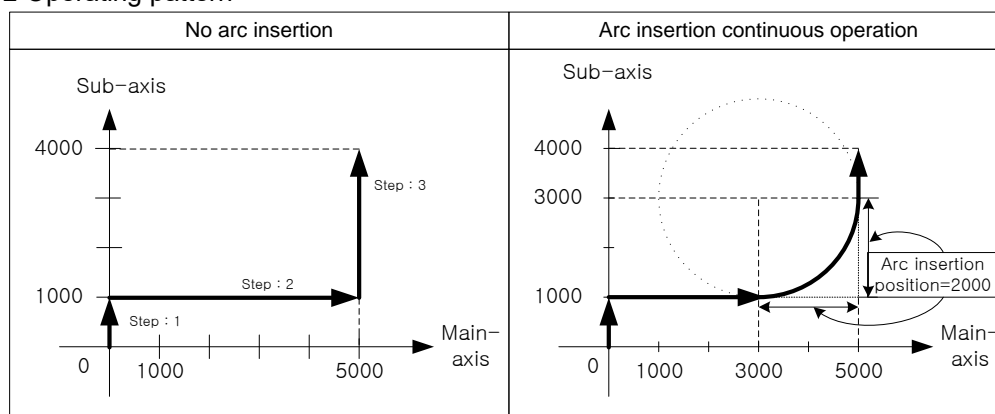

- Description about action

When executing operation step no.1, executes linear interpolation to original target position (0,1000) without circular arc insertion because arc insertion position (2000) is bigger than the length of line 1(1000).

When finishing linear interpolation to target position of operation step no.1 and executing operation step no.2, because arc insertion position (2000) is smaller than line length of step no.2(5000) and no.3(3000), so it recalculates the starting position (target position of linear trajectory no.1) and the target position (Starting position of linear trajectory no.2) of circular interpolation.

It continues to execute linear interpolation to the recalculated target position of operation step no.2 (3000, 1000), and then executes circular interpolation to recalculated starting position of operation step no.3 (5000,3000).

After circular interpolation, it executes linear interpolation to the target position of operation step no.3 (5000,4000). And then positioning will be complete.

9.2.7 Linear Interpolation Control with 3 axes

After executed by start command (「Indirect start」, 「Synchronous start」), then executes interpolation control from starting position to the target position with interpolation axes set as the main axis and sub axes.

(1) Linear interpolation control with absolute coordinate (「Absolute, Linear Interpolation」)

- (a) Executes linear interpolation with 3 axes from starting position to the target position based on positioning data. Positioning control is carried out based on origin point specified by homing.
- (b) The direction of movement depends on the starting position and the target position.
 - Starting position < Target position : Positioning operation in forward
 - Starting position > Target position : Positioning operation in reverse

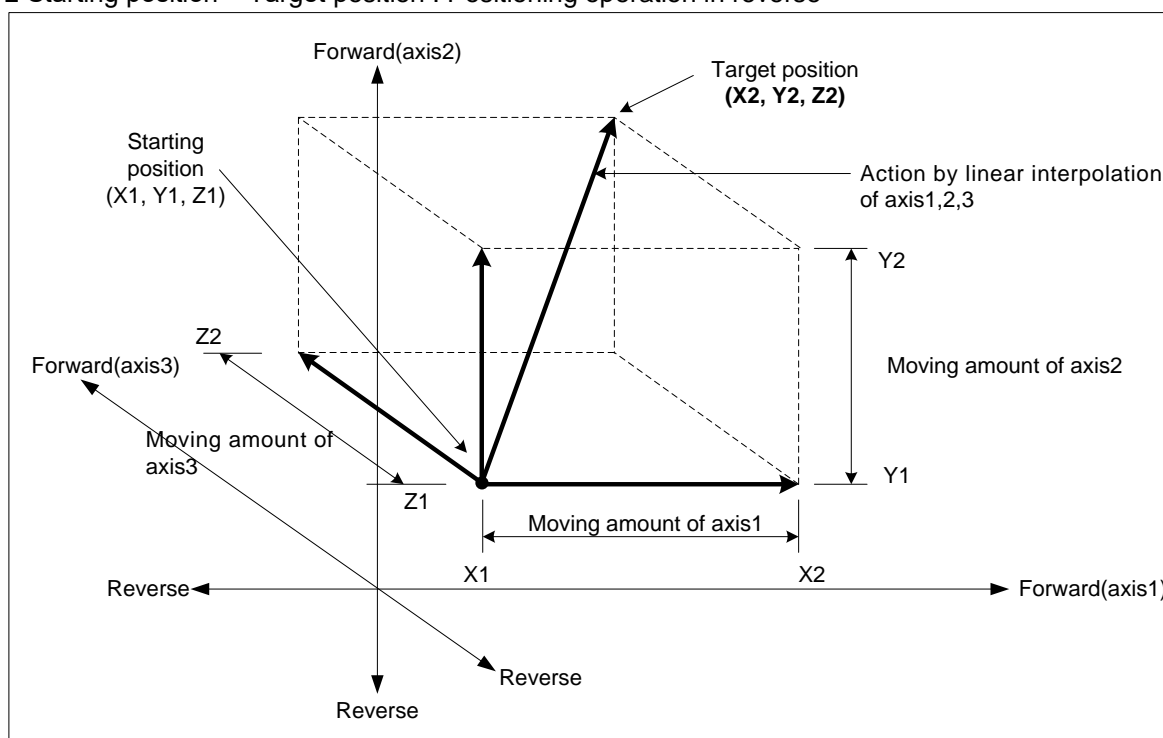

(c) Restrictions

Linear interpolation with 3 axes can not be executed in the case below.

- 「Sub axis setting」 Error (error code : 253)
 - 「Sub axis setting」 of operating data of main axis is "Axis-undecided"
 - 「Sub axis setting」 of operating data of main axis is the same as main axis no.
 - 「Sub axis setting」 of operating data of main axis exceeds the settable axis no.
- If only one axis is set as sub axis, it will execute "linear interpolation control with 2 axes".

(d) Setting example of operating data

Setting items	Main-axis setting (axis1)	Sub-axis setting(axis2)	Sub-axis setting(axis3)	Description
Control method	Absolute, Linear interpolation	Absolute, single axis position control	Absolute, single axis position control	When linear interpolation control is executed by the method of absolute coordinate, set 「Absolute, Linear interpolation」 on the main axis. Set the coordinate of sub-axis as “Absolute” too.
Operating method	Single, End	-	-*1	Set the operating method to execute linear interpolation
Target position [pls]	5000	6000	4000	Set the target position to position on main-axis and sub-axis
Operating speed [pls/s]	1000	-		Linear interpolation speed is determined by main axis speed
Acc. no.	No.1	-		Set acc. no. for acceleration (no.1 ~ no.4)
Dec. no.	No.2	-		Set dec. no. for deceleration. (no.1 ~ no.4)
M code	0	-		When you need to execute auxiliary work based on the interpolation operation, set the M code
Dwell time	500	-		Set dwell time(ms) needed to output the positioning completion signal
Sub-axis setting	Axis2, Axis3	-		Set axes to be used as sub-axis among settable axis in operating data of main-axis

- *1 : It does not need to be set. Whatever value is set as, it does not affect linear interpolation.

Remark

Linear interpolation control is executed on the basis of operating data of main axis.
 Only 「Target position」 item of sub-axis setting affect linear interpolation. In other word, whatever value is set as, it does not affect the operation and errors do not arise.
 Coordinate setting for sub-axis indicates whether target position of the sub-axis is absolute coordinate or incremental coordinate. So in case of linear interpolation control by absolutel coordinate method, coordinate of sub-axis should be 「Absolute」

[Example] axis1 is main axis, axis2 and axis3 are sub axes. Executes linear interpolation with following settings.

- Starting position (2000, 1000, 1000), target position (5000, 6000, 4000)

In this condition, the operation is as follows.

- Setting example of XG-PM

- Operating data of main-axis(axis1)

Step no.	Control method	Operating method	Target position [pls]	Operating speed [pls/s]	Acc. no.	Dec. no.	M code	Dwell time	Sub axis setting
1	Absolute, Linear	Singular, End	5000	1000	No.1	No.1	0	100	Axis2

- Operating data of sub-axis1(axis2)

Step no.	Control method	Operating method	Target position [pls]	Operating speed [pls/s]	Acc. no.	Dec. no.	M code	Dwell time	Sub axis setting
1	Absolute, single-axis position control	Single, End	6000	0	No.1	No.1	0	0	Axis-undecided

- Operating data of sub-axis2(axis3)

Step no.	Control method	Operating method	Target position [pls]	Operating speed [pls/s]	Acc. no.	Dec. no.	M code	Dwell time	Sub axis setting
1	Absolute, single-axis position control	Single, End	4000	0	No.1	No.1	0	0	Axis-undecided

- Operating pattern

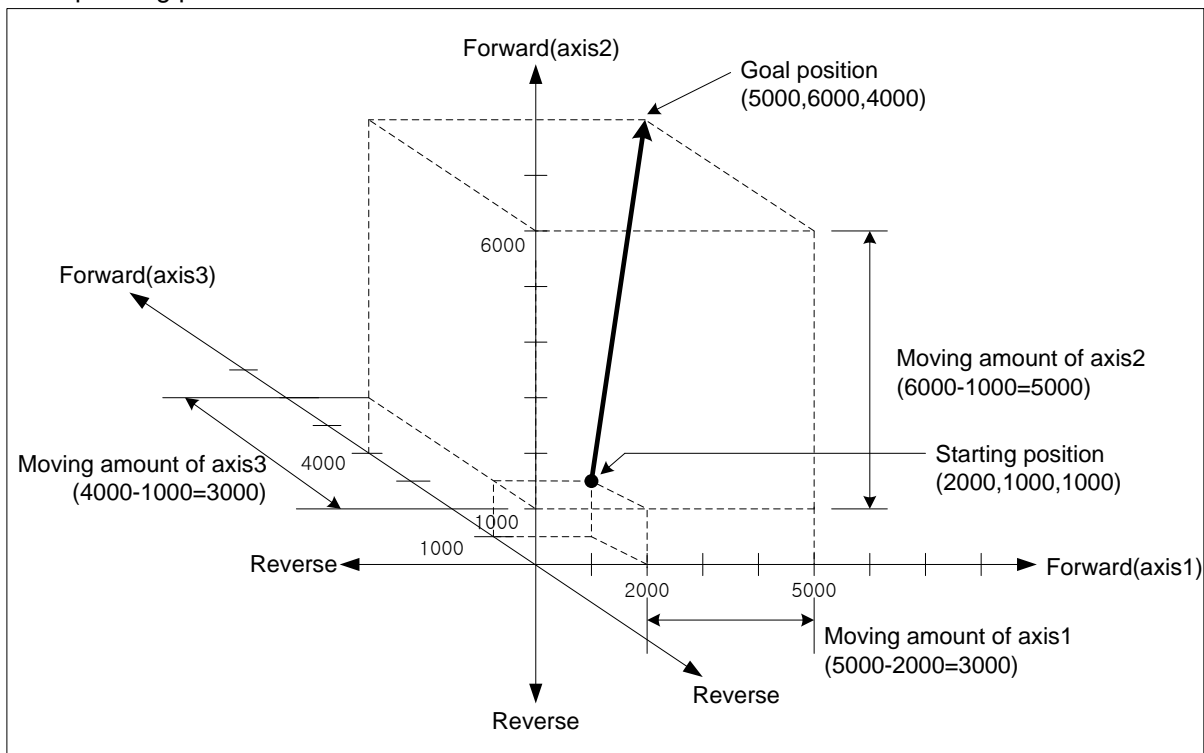

(2) Linear interpolation control with incremental coordinate (「Incremental, Linear Interpolation」)

- (a) Executes 3 axes linear interpolation from starting position to the goal position. Positioning control is carried out based on the current stop position.
- (b) Moving direction depends on the sign of the target position (Moving amount)
 - The sign is positive (+ or nothing) : Positioning operation in forward
 - The sign is negative (-) : Positioning operation in reverse

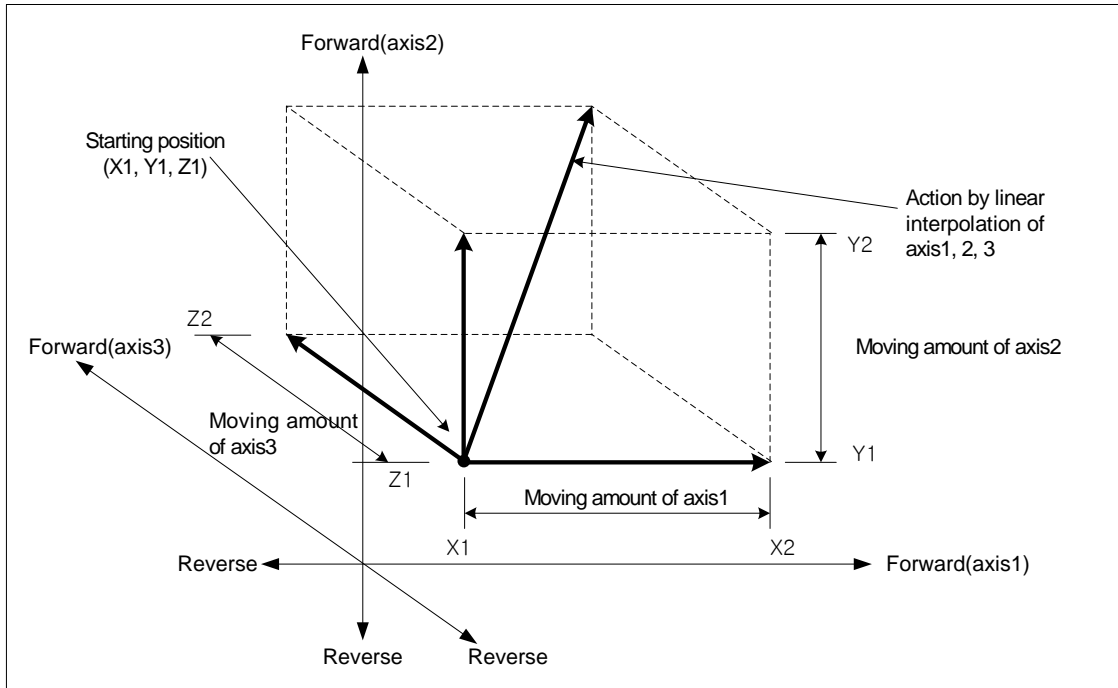

(c) Restrictions

Linear interpolation with 2 axes can not be executed in the case below.

- 「Sub-axis setting」 error (error code : 253)
 - 「Sub-axis setting」 value of operating data of main axis is "Axis-undecided"
 - 「Sub-axis setting」 value of operating data of main axis is same as the main axis no.
 - 「Sub-axis setting」 value of operating data of main axis exceeds settable axis no.
- If only one axis is set as sub axis, it will execute "linear interpolation control with 2 axes".

(d) Setting example of operating data

Setting items	Main-axis setting (axis1)	Sub-axis setting(axis2)	Sub-axis setting(axis3)	Description
Control method	Incremental, Linear interpolation	Incremental, single-axis position control	Incremental, single-axis position control	When linear interpolation control is executed by the incremental coordinate method, set 「Incremental, Linear interpolation」 on the main axis. Set the coordinate of sub-axis as "Incremental" too.
Operating method	Singular, End	- ^{*1}	- ^{*1}	Set the operating method to execute linear interpolation
Target position [pls]	5000	6000	4000	Set the target position to position on main-axis and sub-axis
Operating speed [pls/s]	1000	-		Interpolation speed is determined by main axis speed
Acc. no.	No.1	-		Set acc. no. for acceleration (no.1 ~ no.4)
Dec. no.	No.2	-		Set dec. no. for deceleration. (no.1 ~ no.4)
M code	0	-		When you need to execute auxiliary work based on the interpolation operation, set the M code
Dwell time	500	-		Set dwell time(ms) needed to output the positioning completion signal
Sub-axis setting	Axis2, Axis3	-		Set axes to be used as sub-axis among settable axis in operating data of main-axis

-^{*1} : It does not need to be set. Whatever value is set as, it does not affect linear interpolation.

Remark

Linear interpolation control is executed on basis of operating data of main axis.

Only 「target position」 item of sub-axis setting affect linear interpolation. In other word, whatever value is set as, it does not affect the operation and errors do not arise.

[Example] axis1 is main axis. axis2, 3 are sub axes. Execute linear interpolation with following settings.

- Starting position (2000, 1000, 1000), Target position(Movement amount) (10000, 5000, 5000)
In this condition, the operation is as follows.
- Setting example of XG-PM

▪ Operating data of main-axis(axis1)

Step no.	Control method	Operating method	Target position [pls]	Operating speed [pls/s]	Acc. no.	Dec. no.	M code	Dwell time	Sub axis setting
1	Incremental, Linear	Single, End	10000	1000	No.1	No.1	0	100	Axis2

▪ Operating data of sub-axis1(axis2)

Step no.	Control method	Operating method	Target position [pls]	Operating speed [pls/s]	Acc. no.	Dec. no.	M code	Dwell time	Sub axis setting
1	Incremental, (SNG) POS	Single, End	5000	0	No.1	No.1	0	0	Axis-undecided

▪ Operating data of sub-axis2(axis3)

Step no.	Control method	Operating method	Target position [pls]	Operating speed [pls/s]	Acc. no.	Dec. no.	M code	Dwell time	Sub axis setting
1	Incremental, (SNG) POS	Single, End	5000	0	No.1	No.1	0	0	Axis-undecided

■ Operating pattern

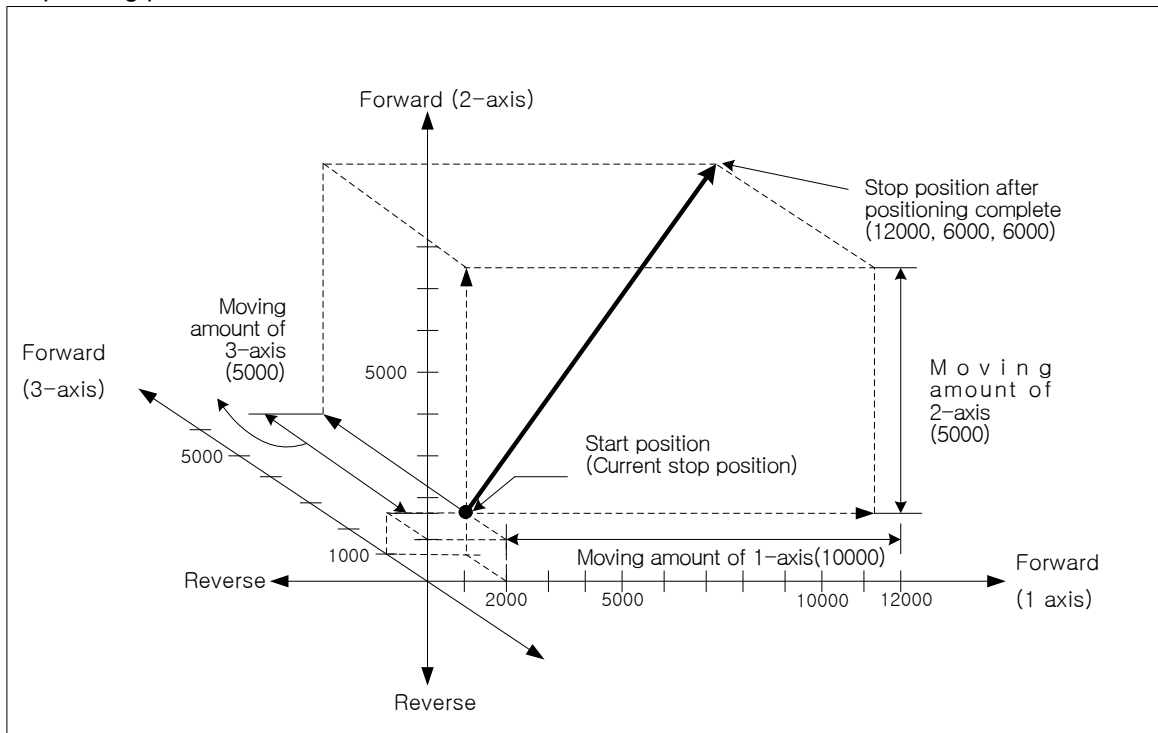

(3) Speed in 3 axes linear interpolation control

Operation speed in linear interpolation is determined based on “Interpolation speed selection” option of extended parameter, main-axis speed or synthetic speed. If operation speed is set on command axis (main), positioning module calculates the speed of sub-axis based on the moving amount. Sub-axis speed and interpolation speed of the object are calculated as follows.

■ Speed in 3 axes linear interpolation (when main axis is selected as interpolation speed)

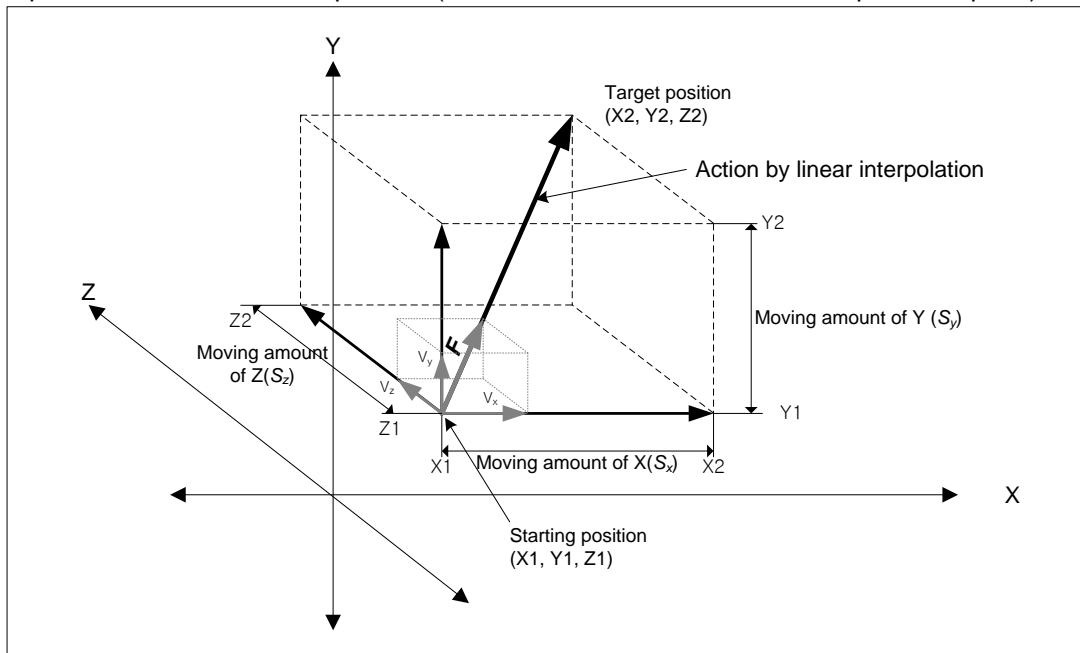

$$\text{Speed of sub}(V_y) = \text{Speed of main}(V_x) \times \frac{\text{Moving amount of Sub}(S_y)}{\text{Moving amount of Main}(S_x)}$$

$$\text{Speed of sub}(V_z) = \text{Speed of main}(V_x) \times \frac{\text{Moving amount of sub}(S_z)}{\text{Moving amount of main}(S_x)}$$

$$\text{Interpolating speed}(F) = \sqrt{V_x^2 + V_y^2 + V_z^2}$$

[Example]

- Starting position (2000, 2000, 1000)
- Target position (6000, 5000, 6000)
- Operating speed: 400 [pls/s]

Speed of sub-axis and interpolating speed are as follows.

$$\text{Speed of sub-axis1} = 400 \times \frac{3000}{4000} = 300 \text{ [pls/s]}$$

$$\text{Speed of sub-axis2} = 400 \times \frac{5000}{4000} = 500 \text{ [pls/s]}$$

$$\text{Interpolating speed} = \sqrt{400^2 + 300^2 + 500^2} \approx 707 \text{ [pls/s]}$$

■ Speed in 3 axes linear interpolation (when synthetic speed is selected as interpolation speed)

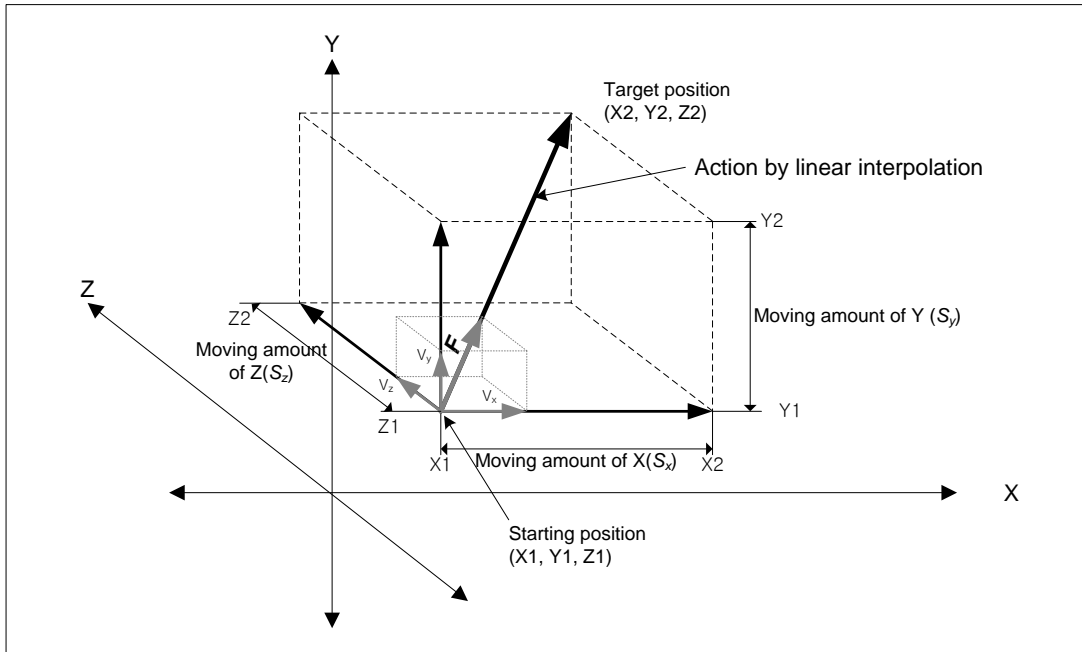

Interpolating speed (F) = Operationspeedsetinpositiondata

$$\text{Interpolating moving amount (S)} = \sqrt{S_x^2 + S_y^2 + S_z^2}$$

$$\text{Main axis speed (V}_x) = \text{Interpolating speed (F)} \times \frac{\text{Main axis moving amount (S}_x)}{\text{Interpolating moving amount (S)}}$$

$$\text{Sub - axis 1 speed (V}_y) = \text{Interpolating speed (F)} \times \frac{\text{Sub - axis 1 moving amount (S}_y)}{\text{Interpolating moving amount (S)}}$$

$$\text{Sub - axis 2 speed (V}_z) = \text{Interpolating speed (F)} \times \frac{\text{Sub - axis 2 moving amount (S}_z)}{\text{Interpolating moving amount (S)}}$$

[Example]

- Starting position (2000, 1000, 1000),
- Target position (6000, 5000, 6000)
- Synthetic speed: 400 [pls/s]

Main-axis speed and sub-axis speed are as follows. (X-axis: main-axis/ Y,Z-axis: sub-axis)

$$\text{Interpolating moving amount} = \sqrt{4000^2 + 4000^2 + 5000^2} \approx 7549.8$$

$$\text{Main axis speed} = 400 \times \frac{4000}{7549.8} \approx 211.9$$

$$\text{Sub-axis 1 speed} = 400 \times \frac{4000}{7549.8} \approx 211.9 \text{ [pls/s]}$$

$$\text{Sub-axis 2 speed} = 400 \times \frac{5000}{7549.8} \approx 264.9 \text{ [pls/s]}$$

Remark

(1) Speed limit for Sub-axis

When using linear interpolation control and moving distance of main < moving distance of sub and "Interpolation speed selection" is "main-axis speed", it is possible that sub-axis speed calculated by the positioning module exceeds 「Speed limit」 of basic parameter. In this case, error (error code: 261) arises and main-axis speed is recalculated for sub-axis not to exceed "Speed Limit" and operates. To prevent errors, reduce the main-axis speed so that sub-axis speed doesn't exceed the "Speed Limit".

(2) The speed when the moving distance of main-axis is 0 and interpolation speed selection" is "main-axis speed

When the moving distance of main-axis is 0, the operating speed of main-axis operating data becomes actual interpolation speed.

In case of linear interpolation with more than 3 axes, the speed of sub-axis is calculated by the formula below.

$$\text{Speed of sub-axis } (V_y) = \text{Interpolating speed } (F) \times \frac{\text{Moving amount of sub-axis } (S_y)}{\text{Merged moving amount } (S_f)}$$

$$\text{Speed of sub-axis } (V_z) = \text{Interpolating speed } (F) \times \frac{\text{Moving amount of sub-axis } (S_z)}{\text{Merged moving amount } (S_f)}$$

9.2.8 Linear Interpolation Control with multiple axes

After executed by start command (「Indirect start」 , 「Synchronous start」), then executes interpolation control from starting position to the target position with interpolation axes set as the main axis and sub axes.

There is no limit to the combination of interpolation axis and maximum 8 axes linear interpolation control is available. Characteristics of action are same as linear interpolation control with 3 axes. For the details, refer to linear interpolation control with 3 axes.

(1) Linear interpolation control with absolute coordinate (「Absolute, Linear Interpolation」)

- (a) Executes multiple axes linear interpolation from starting position to the target position based on positioning data. Positioning control is carried out on the basis of the origin point specified from homing.
- (b) The direction of movement depends on the starting position and the target position.
 - Starting position < Target position : Positioning operation in forward
 - Starting position > Target position : Positioning operation in reverse

(2) Linear interpolation control with incremental coordinate (「Incremental, Linear Interpolation」)

- (a) Executes multiple axes linear interpolation from starting position to the target position. Positioning control is carried out on basis of the current stop position.
- (b) Moving direction depends on the sign of the target position (Moving amount)
 - The sign is positive (+ or nothing) : Positioning operation in forward
 - The sign is negative (-) : Positioning operation in reverse

(3) Speed in multiple axes linear interpolation control

Operation speed in linear interpolation is determined based on “Interpolation speed selection” option of extended parameter, main-axis speed or synthetic speed. If operation speed is set on command axis (main), positioning module calculates the speed of sub-axis based on the moving amount. Sub-axis speed and interpolation speed of the object are calculated as follows.

- Interpolation speed selection is main-axis speed

$$Sub - axis(2axis) \text{ speed } (V_2) = Main \text{ axis speed } (V_1) \times \frac{Sub - axis \text{ moving amount } (S_2)}{Main - axis \text{ moving amount } (S_1)}$$

$$Sub - axis(3axis) \text{ speed } (V_3) = Main - axis \text{ speed } (V_1) \times \frac{Sub - axis \text{ moving amount } (S_3)}{Main - axis \text{ moving amount } (S_1)}$$

:
:

$$Sub - axis(8axis) \text{ speed } (V_8) = Main - axis \text{ speed } (V) \times \frac{Sub - axis \text{ moving amount } (S_8)}{Main - axis \text{ moving amount } (S_1)}$$

$$Interpolation \text{ speed } (F) = \sqrt{V_1^2 + V_2^2 + V_3^2 + \dots + V_8^2}$$

■ Interpolation speed selection is synthetic speed

$$\text{Interpolating speed } (F) = \text{Operations speed set in position data}$$

$$\text{Interpolating moving amount } (S) = \sqrt{S_1^2 + S_2^2 + S_3^2 + \dots + S_8^2}$$

$$\text{Main - axis speed } (V_1) = \text{Interpolating speed } (F) \times \frac{\text{main - axis moving amount } (S_1)}{\text{Interpolating moving amount } (S)}$$

$$\text{Sub - axis 1 speed } (V_2) = \text{Interpolating speed } (F) \times \frac{\text{Sub - axis 1 moving amount } (S_2)}{\text{Interpolating moving amount } (S)}$$

$$\text{Sub - axis 2 speed } (V_3) = \text{Interpolating speed } (F) \times \frac{\text{Sub - axis 2 moving amount } (S_3)}{\text{Interpolating moving amount } (S)}$$

⋮

$$\text{Sub - axis 7 speed } (V_8) = \text{Interpolating speed } (F) \times \frac{\text{Sub - axis 7 moving amount } (S_8)}{\text{Interpolating moving amount } (S)}$$

9.2.9 Middle point-specified Circular Interpolation

After started by start command (「Indirect start」, 「direct start」), executes interpolation operating following the circular path which passes middle point set by “Circular interpolation auxiliary point” using 2 axes.

And, it can execute circular interpolation of over 360 degrees according to the “Circular interpolation turns” setting. There is no limit to the combination of 2 axes. User can randomly use 2 axes among 1~ 8-axis

(1) absolute coordinate, Middle point-specified Circular Interpolation

(「Absolute, circular interpolation」)

- (a) Executes circular interpolation from starting point to target point passing the middle point that is set on operation data.
- (b) Circular trajectory is made using the crossing which is made by dividing between start position and middle point, and between middle point and target position perpendicularly and equally as center point.
- (c) Movement direction is decided automatically depending on the target position and auxiliary point of circular interpolation.

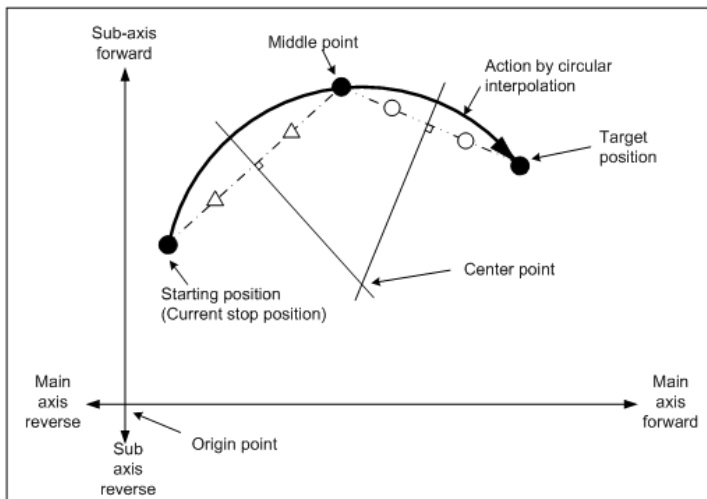

(d) Condition

- In the middle point-specified circular interpolation, you can't draw the circle whose starting position is same as end position. If you want to draw the circle above, use the center point-specified circular interpolation.
- You cannot execute the middle point-specified circular interpolation in the following cases.
 - 「Sub axis setting」 error (Error code : 279)
 - 「Sub-axis setting」 value of operating data of main axis is “Axis-undecided”
 - 「Sub-axis setting」 value of operating data of main axis is same as the main axis no.
 - 「Sub-axis setting」 value of operating data of main axis is axis no. that is not connected to network.
 - In case “degree” is set as control unit of main axis or sub axis, (Error code : 282(Main axis), 283(Sub axis))
 - Middle point set on auxiliary point is same as starting position or target position. (Error code : 284)
 - In case start position is same as target position (Error code : 285)
 - In case calculated radius of circular exceeds 2147483647pls (Error code : 286)
 - In case auxiliary position and target position is in a straight line from start position, (Error code : 287)

Remark

Caution is needed, because 2 axes work simultaneously in the circular interpolation operation.

(1) Available auxiliary operations are as follows ;

- Speed override, Deceleration stop, Emergency stop, Skip operation

(2) Unavailable commands during circular interpolation operation are as follows ;

- Position/Speed switching control, Position override, Continuous operation

(3) The parameter items which are operated by the set value of each axis are as follows ;

- Software upper limit, software lower limit among extended parameter.

(e) Example of operation data setting

Setting item	Main axis (axis1) setting	Sub axis (axis 2) setting	Contents
Control method	Absolute, circular interpolation	Absolute, single-axis position control	When circular interpolation control is executed by the absolute coordinate method, set 「Absolute, circular interpolation」 on the main axis. Set the coordinate of sub-axis as “Absolute” too.
Operation method	Single, End	- ^{*1}	Set operation method for circular interpolation.
Target position [pls]	10000	0	Set the target position for positioning on the main, sub axes
Operation speed [pls/s]	1000	-	Circular interpolation uses the method of designating composition speed. Set the composition speed at the main-axis
Acceleration No.	No.1	-	Set Acc. No. for acceleration (no.1 ~ no.4)
Deceleration No.	No.2	-	Set Dec. No. for deceleration. (no.1 ~ no.4)
M code	0	-	When you need to execute auxiliary work based on the interpolation operation, set the M code
Dwell time	500	-	Set dwell time(ms) needed to output the positioning completion signal
Sub-axis setting	Axis 2	-	Set an axis to be used as sub-axis among settable axis in operating data of main-axis
Circular interpolation Auxiliary point	5000	5000	In case of middle point specified circular interpolation, set the position of the middle point where circular arc passes
Circular interpolation mode	Middle point	-	In case of middle point specified circular interpolation, select 「middle point」 on the main axis.
Circular interpolation turns	0	-	When user want to draw circle of over 360 degree, set the number of turns of circular arc.
Helical interpolation	Don't use	-	In case of circular interpolation, select 「Do not use」 on the main axis.

-^{*1} : You need not set. Whatever you set, there is no effect to circular interpolation.

Remark

The middle point specified circular interpolation is operated by operation data of main axis (command axis).

In case of the middle point specified circular interpolation, sub axis items except for 「Target position」, 「circular interpolation auxiliary point」 don't affect the operation. That is, whatever you set, those don't affect the operation and error doesn't occur.

But, coordinate setting of sub-axis control method indicates whether target position is absolute coordinate or incremental coordinate. So in case of circular interpolation control by absolute coordinate method, set the coordinate of sub-axis as "absolute" too.

[Example] executes middle point-specified circular interpolation, absolute coordinate (main axis; axis 1, sub axis; axis 2)

- In case of Start position (0, 0), Target position (10000, 6000) and Auxiliary point (2000, 6000), operation is as follows;
- Example of setting in the XG-PM
 - Main axis(axis1) operation data

Step No.	Control Method	Operation method	Target position [pls]	Operation Speed [pls/s]	Acc. No.	Dec. No.	M code	Dwell time	Sub axis setting	Circular interpolation Auxiliary point	Circular interpolation mode	Circular interpolation turns	Helical interpolation
1	Absolute, Circular interpolation	Single, End	13000	1000	No. 1	No. 1	0	100	Axis 2	10000	Middle point	0	Do not use

- The axis(axis 2) of ordinates operation data

Step No.	Control Method	Operation method	Target position [pls]	Operation Speed [pls/s]	Acc. No.	Dec. No.	M code	Dwell time	Sub axis setting	Circular interpolation Auxiliary point	Circular interpolation mode	Circular interpolation turns	Helical interpolation
1	Absolute, Single-axis position control	Single, End	9000	0	No. 1	No. 1	0	0	none	7500	Middle point	0	Do not use

■ Operation pattern

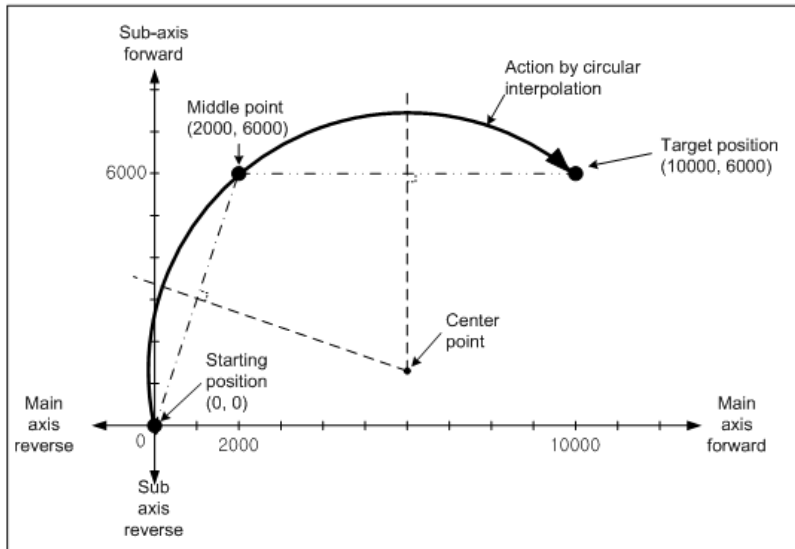

(2) Middle point specified Circular interpolation by incremental coordinate

(「Incremental, circular interpolation」)

- Operates circular interpolation from start position to target position as much as amount of set movement passing the middle.
- Middle point position is the position increased from current stop position as much as the set value on 「Circular interpolation auxiliary point」.
- The intersection of perpendicular bisectors between starting position and middle point and perpendicular bisectors between the current stop position and the position increased from current stop position as much as target position will be the center-point of the arc.
- Movement direction is decided by the set target position and circular interpolation auxiliary point.

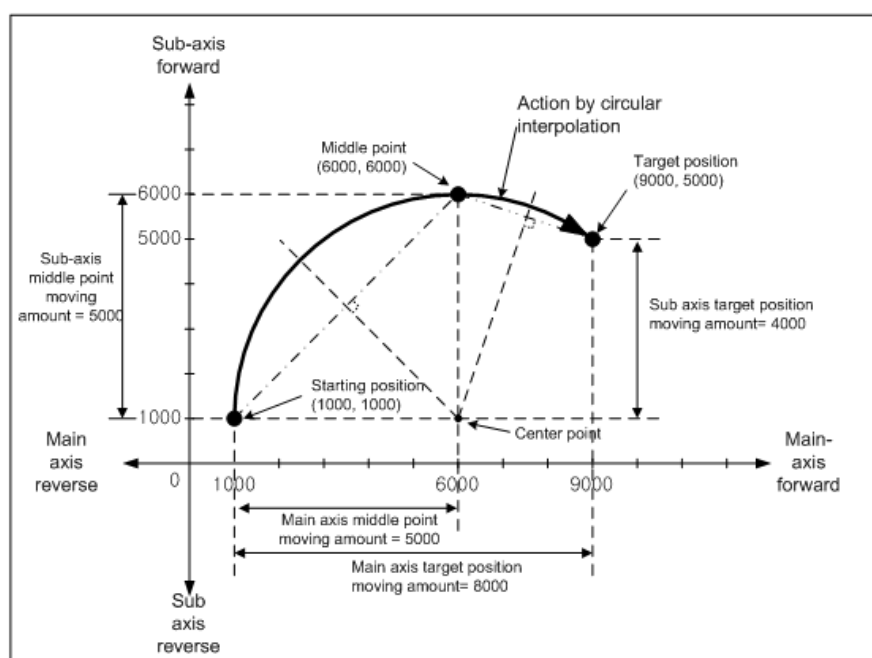

(e) Condition

- In the middle point-specified circular interpolation, you can't draw the circle whose starting position is same as end position. If you want to draw the circle above, use the center point-specified circular interpolation.
- You cannot execute the middle point-specified circular interpolation in the following cases.
 - 「Sub axis setting」 error (Error code : 279)
 - 「Sub-axis setting」 value of operating data of main axis is "Axis-undecided"
 - 「Sub-axis setting」 value of operating data of main axis is same as the main axis no.
 - 「Sub-axis setting」 value of operating data of main axis is axis no. that is not connected to network.
 - In case "degree" is set as control unit of main axis or sub axis, (Error code : 282(Main axis), 283(Sub axis))
 - Middle point set on auxiliary point is same as starting position or target position. (Error code : 284)
 - In case start position is same as target position (Error code : 285)
 - In case calculated radius of circular exceeds 2147483647pls (Error code : 286)
 - In case auxiliary position and target position is in a straight line from start position, (Error code : 287)

(f) Example of operation data setting

Setting item	Main axis (axis1) setting	Sub axis (axis 2) setting	Contents
Control method	Incremental, circular interpolation	Incremental, single-axis position control	When circular interpolation control is executed by the incremental coordinate method, set 「incremental, circular interpolation」 on the main axis. Set the coordinate of sub-axis as “incremental” too.
Operation method	Single, End	- *1	Set operation method for circular interpolation.
Target position [pls]	10000	0	Set the target position by incremental amount from current position
Operation speed [pls/s]	1000	-	Circular interpolation uses the method of composition speed. Set the composition speed at the main-axis
Acceleration No.	No.1	-	Set Acc. No. for acceleration (no.1 ~ no.4)
Deceleration No.	No.2	-	Set Dec. No. for deceleration. (no.1 ~ no.4)
M code	0	-	When you need to execute auxiliary work based on the interpolation operation, set the M code
Dwell time	500	-	Set dwell time(ms) needed to output the positioning completion signal
Sub-axis setting	Axis 2	-	Set an axis to be used as sub-axis among settable axis in operating data of main-axis
Circular interpolation Auxiliary point	5000	5000	Set the middle point position by incremental amount from current position
Circular interpolation mode	Middle point	-	In case of middle point specified circular interpolation, select 「middle point」 on the main axis.
Circular interpolation turns	0	-	When user want to draw circle of over 360 degree, set the number of turns of circular arc.
Helical interpolation	Don't use	-	In case of circular interpolation, select 「Do not use」 on the main axis.

- *1 : You need not set. Whatever you set, there is no effect to circular interpolation.

Remark

The middle point specified circular interpolation is operated by operation data of main axis (command axis).
 In case of the middle point specified circular interpolation, sub axis items except for 「Coordinate」, 「Target position」, 「circular interpolation auxiliary point」 don't affect the operation. That is, whatever you set, those don't affect the operation and error doesn't occur.
 But, coordinate setting of sub-axis control method indicates whether target position is absolute coordinate or incremental coordinate. So in case of circular interpolation control by incremental coordinate method, set the coordinate of sub-axis as “incremental” too.

[Example] Operates middle pint-specified circular interpolation, incremental coordinate with axis 1 (main axis) and axis 2 (sub axis)

■ Start position : (1000, 1000)

Target position (amount of movement) setting : (8000, 4000)

Auxiliary point (amount of movement) setting : (5000, 5000)

In this case operation is as follows:

■ Example of setting XG-PM

▪ Main axis(axis 1) Operation data

Step No.	Control Method	Operation method	Target position [pls]	Operation Speed [pls/s]	Acc. No.	Dec. No.	M code	Dwell time	Sub axis setting	Circular interpolation Auxiliary point	Circular interpolation mode	Circular interpolation turns	Helical interpolation
1	Incremental, Circular interpolation	Single, End	8000	1000	No. 1	No. 1	0	100	Axis 2	5000	Middle point	0	Do not use

▪ Sub axis(axis 2) Operation data

Step No.	Control Method	Operation method	Target position [pls]	Operation Speed [pls/s]	Acc. No.	Dec. No.	M code	Dwell time	Sub axis setting	Circular interpolation Auxiliary point	Circular interpolation mode	Circular interpolation turns	Helical interpolation
1	Absolute, single-axis position control	Single, End	4000	0	No. 1	No. 1	0	0	None	5000	Middle point	0	Do not use

■ Operation pattern

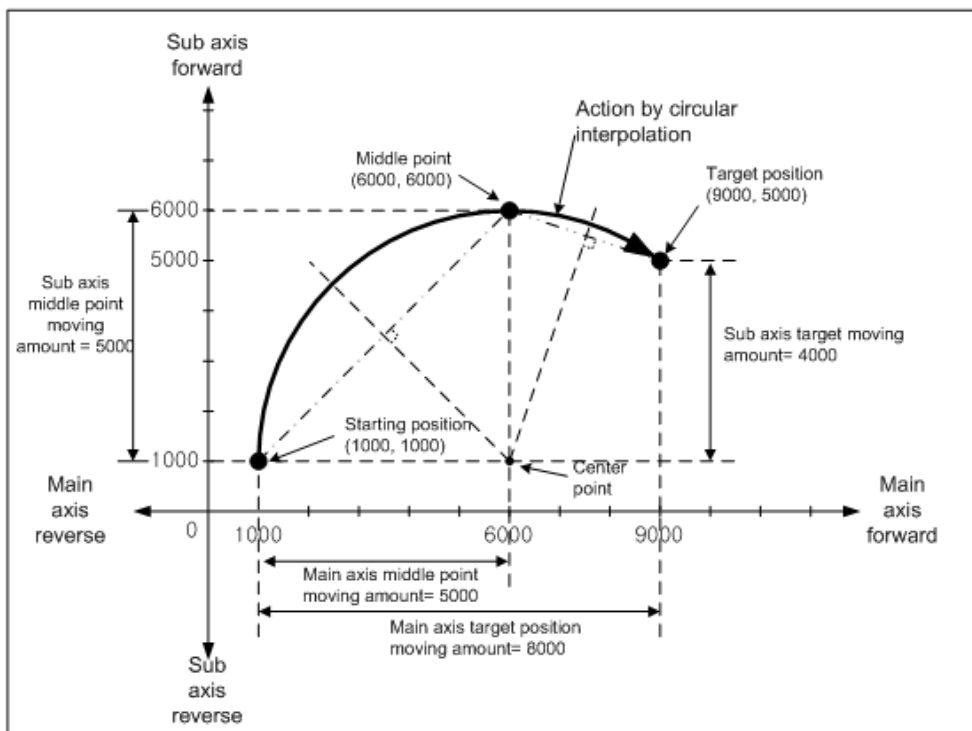

9.2.10 Center point - specified Circular interpolation

After operated by starting command (「indirect start」 , 「Simultaneous Start」), it operates interpolation along the trace of the circle whose center is specified center point by using 2 axes in the set circular interpolation rotation direction.

Circular interpolation over 360 degrees is available according to 「Circular interpolation turns」 .

There is no limit to the composition of 2 axes. User can select 2 axes among 1~ 8-axis randomly.

(1) Center point-specified Circular interpolation, Absolute Coordinate

(「Absolute, Circular interpolation」)

(a) Operates circular interpolation from start position to target position along the trace of circle whose radius is distance from center point to start position. 「Circular interpolation auxiliary point」 indicates the center point of the circle.

(b) Moving direction depends on the set direction on “circular interpolation mode” of operation data.

- 「Midpoint, CW」 - Circular interpolation going clockwise from current position.
- 「Midpoint, CCW」 - Circular interpolation going counterclockwise from current position.

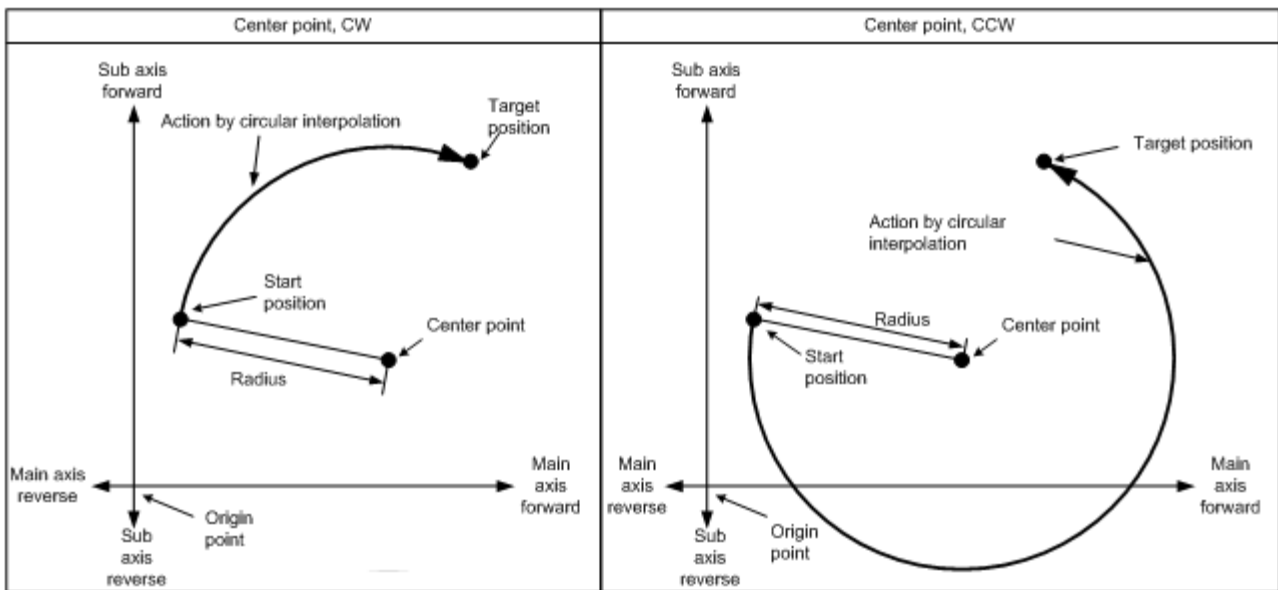

- (c) If target position is same as start position, you can execute circular interpolation whose circle radius is distance from center point to starting position (=target position)

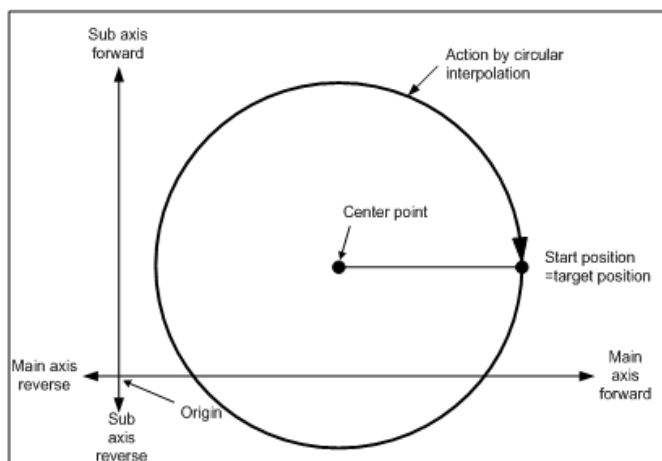

(d) Condition

- You cannot execute the center point-specified circular interpolation in the following cases.
 - 「Sub axis setting」 error (Error code : 279)
 - 「Sub-axis setting」 value of operating data of main axis is “Axis-undecided”
 - 「Sub-axis setting」 value of operating data of main axis is same as the main axis no.
 - 「Sub-axis setting」 value of operating data of main axis is axis no. that is not connected to network.
 - In case “degree” is set as control unit of main axis or sub axis, (Error code : 282(Main axis), 283(Sub axis))
 - In case center point set on auxiliary point is same as starting position or target position. (Error code : 284)
 - In case calculated radius of circular exceeds 2147483647pls (Error code : 286)

Remark

Be careful during starting circular interpolation, because 2 axes act at a time.

1. Available auxiliary operation is as follows:
 - Speed override, Deceleration stop, Emergency stop, Skip operation
2. Unavailable command with circular interpolation is as follows:
 - Position/Speed switching control, Position override, Continuous operation
3. The parameter item that it is operated by set value per each axes is as follows:
 - Software upper limit, Software lower limit among extended parameter items

(e) Example of operation data setting

Setting item	Main axis (axis1) setting	Sub axis (axis 2) setting	Contents
Control method	Absolute, circular interpolation	Absolute, single-axis position control	When circular interpolation control is executed by the absolute coordinate method, set 「absolute, circular interpolation」 on the main axis. Set the coordinate of sub-axis as “absolute” too.
Operation method	Single, End	- *1	Set operation method for circular interpolation.
Target position [pls]	10000	0	Set the target position for positioning on the main, sub axes
Operation speed [pls/s]	1000	-	Circular interpolation uses the method of composition speed. Set the composition speed at the main-axis
Acceleration No.	No.1	-	Set Acc. No. for acceleration (no.1 ~ no.4)
Deceleration No.	No.2	-	Set Dec. No. for deceleration. (no.1 ~ no.4)
M code	0	-	When you need to execute auxiliary work based on the interpolation operation, set the M code
Dwell time	500	-	Set dwell time(ms) needed to output the positioning completion signal
Sub-axis setting	Axis 2	-	Set an axis to be used as sub-axis among settable axis in operating data of main-axis
Circular interpolation Auxiliary point	5000	-5000	Set the position of the center point
Circular interpolation mode	Center point, CW	-	Select 「Center point, CW」 on the main axis.
Circular interpolation turns	0	-	When user want to draw circle of over 360 degree, set the number of turns of circular arc.
Helical interpolation	Don't use	-	In case of circular interpolation, select 「Do not use」 on the main axis.

- *1 : You need not set. Whatever you set, there is no effect to circular interpolation.

Remark

The center - point specified circular interpolation is operated by operation data of main axis (command axis).
 In case of the center point - specified circular interpolation, sub axis items except for 「Target position」 , 「circular interpolation auxiliary point 」 don't affect the operation. That is, whatever you set, those don't affect the operation and error doesn't occur.
 But, coordinate setting of sub-axis control method indicates whether target position is absolute coordinate or incremental coordinate. So in case of circular interpolation control by absolute coordinate method, set the coordinate of sub-axis as “Absolute” too.

**[Example] Operates center point - specified circular interpolation, absolute coordinate
(main axis; 1-axis, sub axis; 2-axis)**

- Start position (0, 0), Target position (0, 0), Auxiliary point (1000, 1000), direction of rotation :CW
- Example of setting in the XG-PM
 - Main axis (axis1) operation data

Step No.	Control Method	Operation method	Target position [pls]	Operation Speed [pls/s]	Acc. No.	Dec. No.	M code	Dwell time	Sub axis setting	Circular interpolation Auxiliary point	Circular interpolation mode	Circular interpolation turns	Helical interpolation
1	Absolute, Circular interpolation	Single, End	0	1000	No. 1	No. 1	0	100	Axis 2	1000	Center point ,CW	0	Do not use

▪ Sub axis (axis 2) operation data

Step No.	Control Method	Operation method	Target position [pls]	Operation Speed [pls/s]	Acc. No.	Dec. No.	M code	Dwell time	Sub axis setting	Circular interpolation Auxiliary point	Circular Interpolation mode	Circular interpolation turns	Helical interpolation
1	Absolute, single-axis position control	Single, End	0	0	No.1	No.1	0	0	None	1000	Center point, CW	0	Do not use

■ Operation pattern

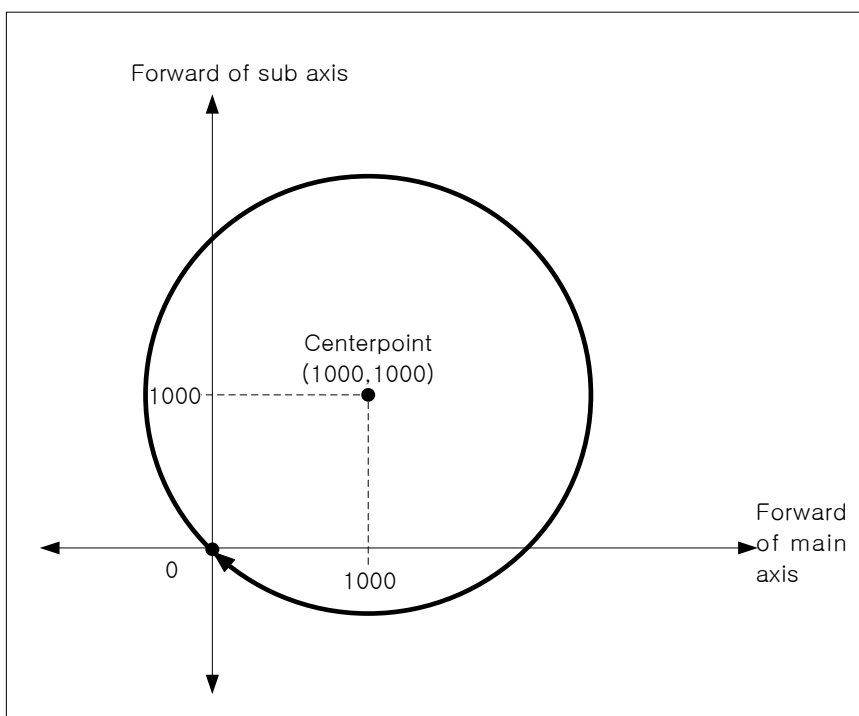

(2) Center point – specified Circular interpolation control, incremental coordinate
 (「Incremental, Circular interpolation」)

- (a) Starts operation at starting position and then executes circular interpolation by already set moving amount, along the trace of the circle which has a distance between starting position and center point as radius.
 「Circular interpolation auxiliary point」 means the moving amount between the current position and center point.
- (b) Moving direction is decided to set direction on “circular interpolation mode” of operation data.
- 「Center point, CW」 - Circular interpolation going clockwise from current position.
 - 「Center point, CCW」 - Circular interpolation going counterclockwise from current position.

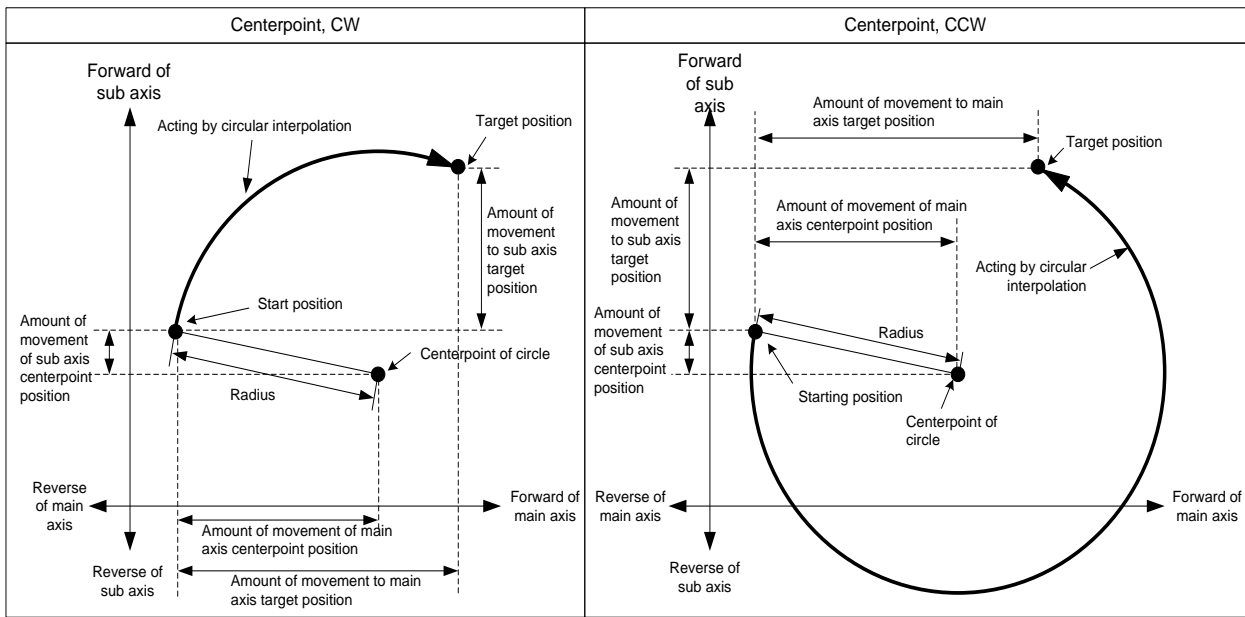

- (c) If you set target position of main axis and sub axis as “0”, starting position will be same as target position and can execute circular interpolation that it is drawing circle whose radius is distance from starting position to center-point.

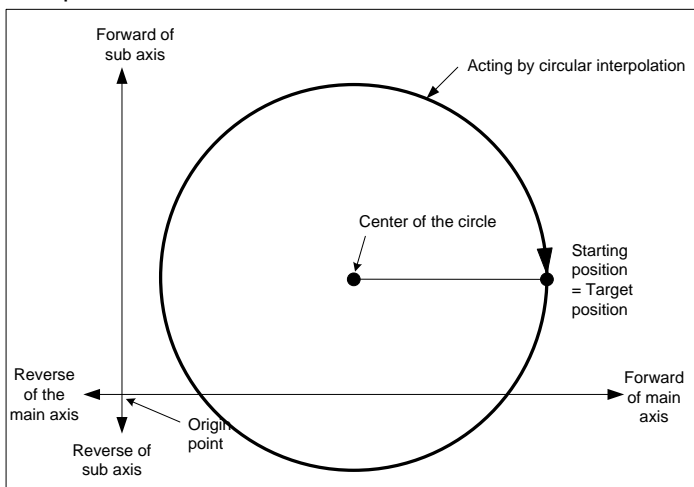

(d) Condition

- You cannot execute the center point-specified circular interpolation in the following cases.
 - 「Sub axis setting」 error (Error code : 279)
 - 「Sub-axis setting」 value of operating data of main axis is “Axis-undecided”
 - 「Sub-axis setting」 value of operating data of main axis is same as the main axis no.
 - 「Sub-axis setting」 value of operating data of main axis is axis no. that is not connected to network.
 - In case “degree” is set as control unit of main axis or sub axis, (Error code : 282(Main axis), 283(Sub axis))
 - In case center point set on auxiliary point is same as starting position or target position. (Error code : 284)
 - In case calculated radius of circular exceeds 2147483647pls (Error code : 286)

(e) Example of operation data setting

Setting item	Main axis (axis1) setting	Sub axis (axis 2) setting	Contents
Control method	Incremental, circular interpolation	Incremental, single-axis position control	When circular interpolation control is executed by the incremental coordinate method, set 「incremental, circular interpolation」 on the main axis. Set the coordinate of sub-axis as “incremental” too.
Operation method	Single, End	- ^{*1}	Set operation method for circular interpolation.
Target position [pls]	10000	0	Set the target position by incremental amount from current position
Operation speed [pls/s]	1000	-	Circular interpolation uses the method of composition speed. Set the composition speed at the main-axis
Acceleration No.	No.1	-	Set Acc. No. for acceleration (no.1 ~ no.4)
Deceleration No.	No.2	-	Set Dec. No. for deceleration. (no.1 ~ no.4)
M code	0	-	When you need to execute auxiliary work based on the interpolation operation, set the M code
Dwell time	500	-	Set dwell time(ms) needed to output the positioning completion signal
Sub-axis setting	Axis 2	-	Set an axis to be used as sub-axis among settable axis in operating data of main-axis
Circular interpolation Auxiliary point	5000	-5000	Set the center point position by incremental amount from current position
Circular interpolation mode	Center point, CW	-	Select 「Center point, CW」 on the main axis.
Circular interpolation turns	0	-	When user want to draw circle of over 360 degree, set the number of turns of circular arc.
Helical interpolation	Don't use	-	In case of circular interpolation, select 「Do not use」 on the main axis.

-^{*1} : You need not set. Whatever you set, there is no effect to circular interpolation.

Remark

The center point specified circular interpolation is operated by operation data of main axis (command axis).
 In case of the center point specified circular interpolation, sub axis items except for 「Target position」, 「circular interpolation auxiliary point」 don't affect the operation. That is, whatever you set, those don't affect the operation and error doesn't occur.
 But, coordinate setting of sub-axis control method indicates whether target position is absolute coordinate or incremental coordinate. So in case of circular interpolation control by incremental coordinate method, set the coordinate of sub-axis as "incremental" too.

[Example] Operates center point – specified circular interpolation, Incremental coordinate with axis 1 (main axis), with axis 2 (sub axis)

- Start position: (0, 0)
 Target position (amount of movement): (2000, 0)
 Auxiliary point (amount of movement): (1000, 0)
 Direction of rotations: CW
 In this case, operation is as follows:

- Example of setting XG-PM
 - Main axis (axis 1) Operation data

Step No.	Control Method	Operation method	Target position [pls]	Operation Speed [pls/s]	Acc. No.	Dec. No.	M code	Dwell time	Sub axis setting	Circular interpolation Auxiliary point	Circular Interpolation mode	Circular interpolation turns	Helical Interpolation
1	Incremental, Circular interpolation	Single, Keep	2000	1000	No. 1	No. 1	0	100	Axis 2	1000	Center-point ,CW	0	Do not use
1	Incremental, Circular interpolation	Single, End	2000	1000	No. 1	No. 1	0	100	Axis 2	1000	Center-point ,CW	0	Do not use

- Sub axis (axis 2) Operation data

Step No.	Control Method	Operation method	Target position [pls]	Operation Speed [pls/s]	Acc. No.	Dec. No.	M code	Dwell time	Sub axis setting	Circular interpolation Auxiliary point	Circular Interpolation mode	Circular interpolation turns	Helical interpolation
1	Incremental, single-axis position control	Single, End	0	0	No. 1	No. 1	0	0	None	0	Midpoint ,CW	0	Do not use
1	Incremental, single-axis position control	Single, End	0	0	No. 1	No. 1	0	0	None	0	Midpoint ,CW	0	Do not use

■ Operation pattern

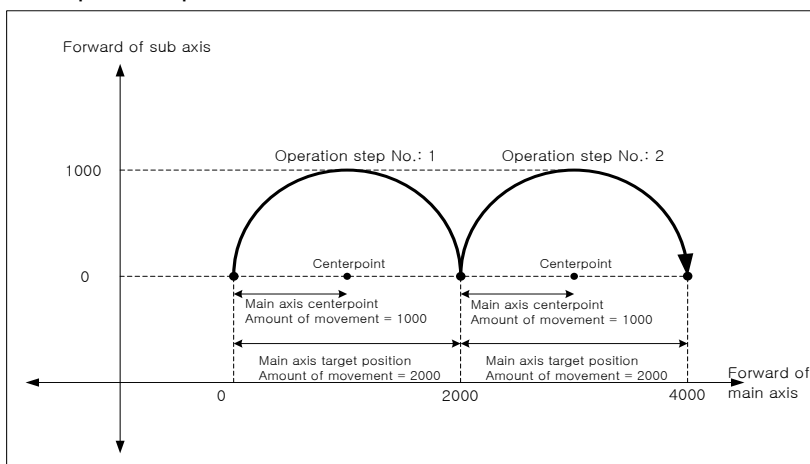

(3) Circular interpolation control whose radius of starting point is different with radius of ending point.

(a) According to set value of target position, distance A which it is distance from start point to center point may be different with distance B which it is distance from target position to center point (End point, Radius). At this time, normal circular arc operation is not available.

When starting point radius have a difference with end point radius, the positioning module calculates angular velocity from the set operation speed, and operates circular interpolation compensating a difference of radius in proportion to that angular velocity.

(b) In case of starting point radius has some difference with ending point radius, compensating speed is as follows:

- Radius of starting point > Radius of ending point: The more near from target position, the slower.
- Radius of starting point < Radius of ending point: The more near from target position, the faster.

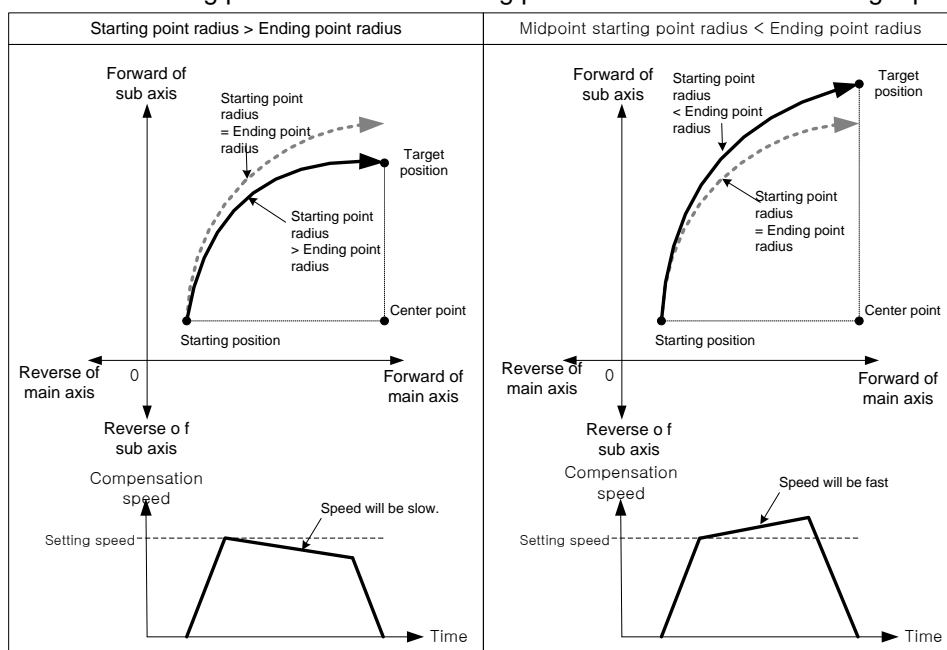

Remark

In case of “Starting point radius < Ending point radius”, the closer to target position the object gets, the faster speed is. Sometimes it exceeds 「Speed limit」 of parameter. When operating circular interpolation, in case starting point radius is shorter than ending point radius, XBF-PN04B/PN08B lowers speed not to exceed 「Speed limit」. With that method, even if it gets closer to target position, it can't exceed the 「Speed limit」.

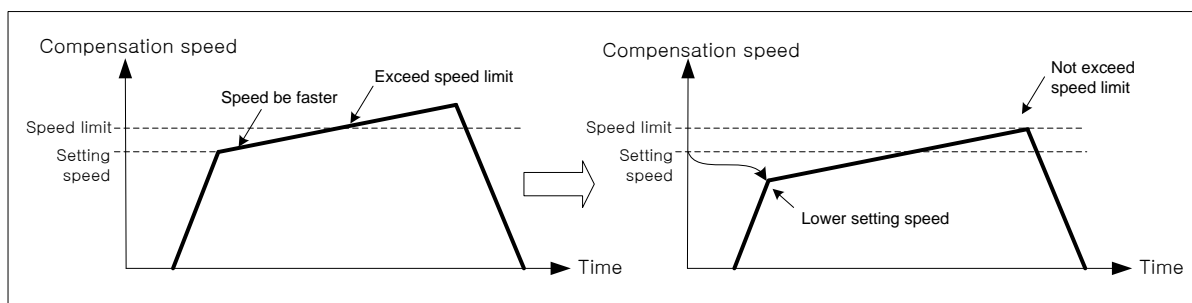

(4) The number of circular interpolation rotation in absolute coordinate

- (a) In case of center point - specified circular interpolation, absolute coordinate, when setting “Circular interpolation turns” is more than 1, if you stop it by Dec. stop command and restart interpolation operation, it doesn’t operate along the circular arc set again at this stop point and operates along the circular arc set at the previous start position. That is, in absolute coordinate, center point – specified circular interpolation, it operates according to rotation number at start position.
- (b) Even if it decelerates and stops, it operates original circular interpolation by restart.
- (c) Condition

In the following case, current position changes after deceleration stop command. The number of circular interpolation rotation is not the number of absolute rotations. It operates by the number of incremental rotations.

- After executing positioning command except for current step indirect start (Directing start, Jog operation, Inching operation, Sync. operation, etc),
- After executing “Current position change” command
- After executing “Servo off” command

[Example] operates center-point circular interpolation, absolute coordinate with axis 1 (main axis), with axis 2 (sub axis)

- Starting position (100, 500), Target position (600, 300), Auxiliary position (600, 500), Direction of rotations: CW, operation is as follows:
- Example of setting XG-PM

▪ Main axis (axis 1) operation data

Step No.	Control Method	Operation method	Target position [pls]	Operation Speed [pls/s]	Acc. No.	Dec. No.	M code	Dwell time	Sub axis setting	Circular interpolation Auxiliary point	Circular Interpolation mode	Circular interpolation turns	Helical interpolation
1	Absolute, circular interpolation	Single, End	600	1000	No.1	No.1	0	100	Axis 2	600	Center point, CW	3	Do not use

▪ Sub axis (axis 2) operation data

Step No.	Control Method	Operation method	Target position [pls]	Operation Speed [pls/s]	Acc. No.	Dec. No.	M code	Dwell time	Sub axis setting	Circular interpolation Auxiliary point	Circular interpolation mode	Circular interpolation turns	Helical interpolation
1	Absolute, single-axis position control	Single, End	300	0	No.1	No.1	0	0	None	500	Middle point	0	Do not use

■ Operation pattern

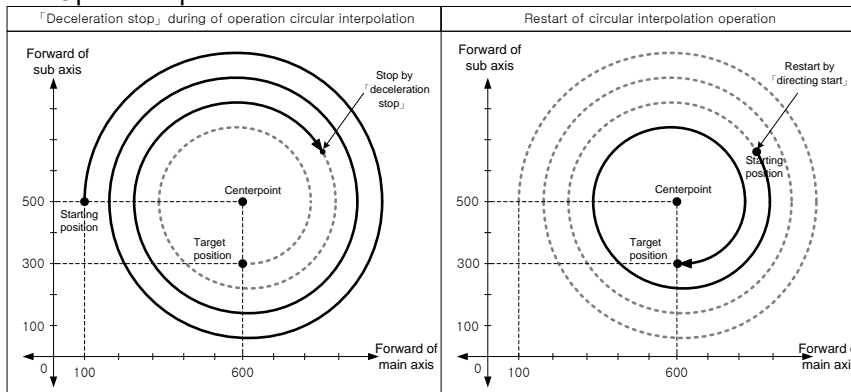

When you restart the same step number after stopping it by Dec. stop command, it doesn’t rotate 3 times at the stop position. Since it rotated 2 times previous operation, it executes circular interpolation of one time rotation to go target position.

9.2.11 Circular interpolation control with designated radius

After operated by starting command (「indirect start」 , 「Simultaneous Start」), it operates interpolation along the trace of the circle made by the specified radius.

Circular interpolation over 360 degrees is available according to 「Circular interpolation turns」 .

There is no limit to the composition of 2 axes. User can select 2 axes among 1~ 8-axis randomly.

(1) Radius specified Circular interpolation, absolute coordinate (「Absolute, Circular interpolation」)

- (a) Starts operating at starting position and execute circular interpolation along the trace of the circle which has radius specified by auxiliary point of main-axis operation data. Center point of Circular arc depends on the turning direction (CW, CCW) of 「Circular interpolation mode」 and size setting of circular arc (Circular arc<180°, Circular arc>=180°).

Circular interpolation mode	Description
Radius, CW, Arc<180°	Executes circular interpolation in clockwise and the arc is smaller than 180°
Radius, CW, Arc>=180°	Executes circular interpolation in clockwise and the arc is bigger than 180°
Radius, CCW, Arc<180°	Executes circular interpolation in counterclockwise and the arc is smaller than 180° or same.
Radius, CCW, Arc>=180°	Executes circular interpolation in counterclockwise and the arc is bigger than 180° or same.

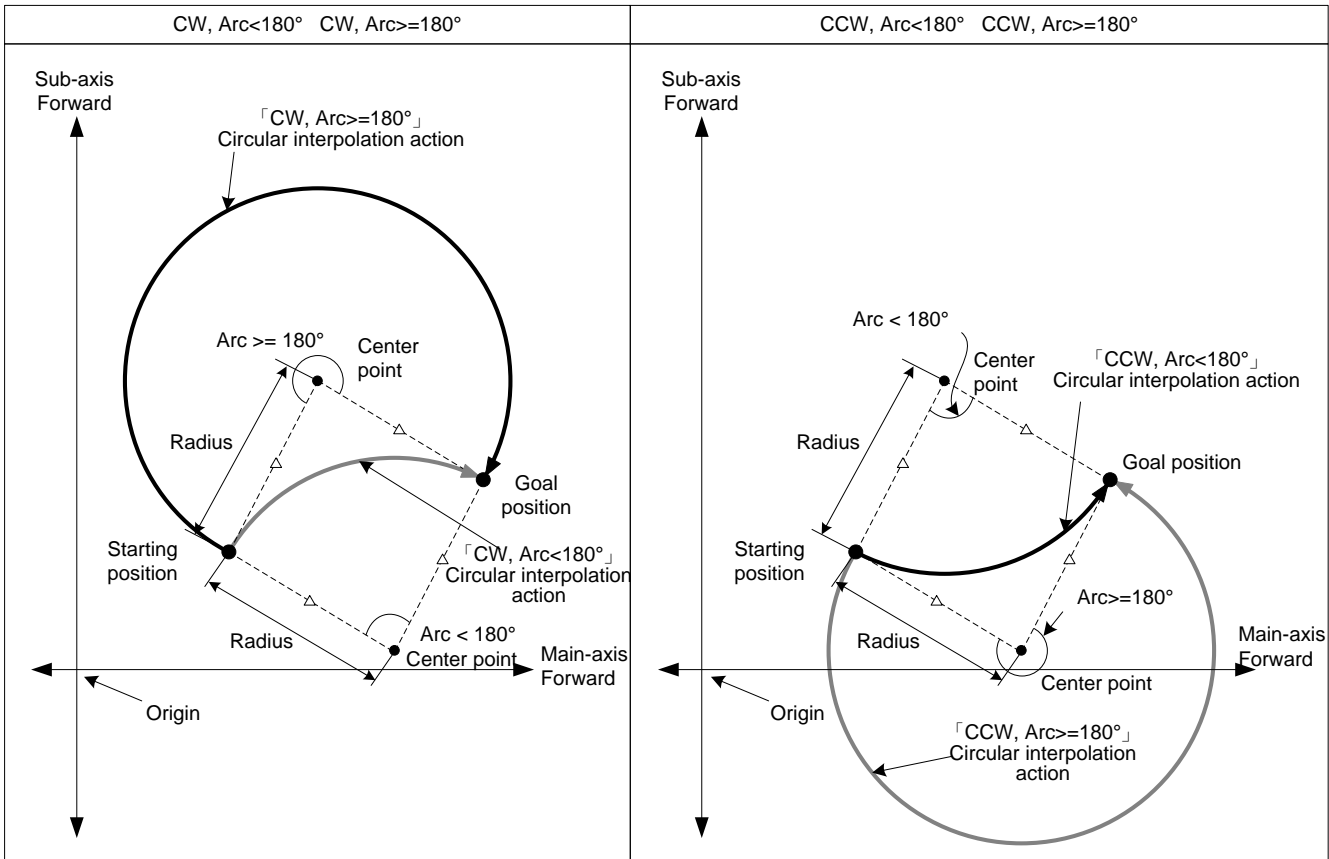

(b) Restrictions

- Radius specified circular interpolation can not draw an exact circle that the starting position and ending position are same. If you want to draw that, use center point - specified circular interpolation.
- In the cases below, error would arise and circular interpolation can not be executed.
 - 「Sub-axis setting」 error (error code: 279)
 - Value of 「Sub-axis setting」 is “Axis-undecided”
 - 「Sub axis setting」 of main axis operating data is the same as main axis no.
 - 「Sub axis setting」 of main axis operating data is the axis no. that is not connected to the network.
 - Control unit of main or sub axis is set as “degree”. (error code : 282(main), 283(sub))
 - Starting position and goal position are same (error code: 285)
 - Radius value of circular interpolation of main-axis operating data is smaller than half of the length from starting position to target position
 - When Radius < (R x 0.8) : Error (error code:270)
 - > When Radius < (R x 80%): Error
 - When (R x 0.8) <= Radius < R
 - : Executes circular interpolation after reset the radius to R. In other words, executes circular interpolation by setting the center of the line from starting position to goal position as center point.
 - > When Radius >= (R x 80%) or Radius < (R x 100%): Effective Radius

Remark

If executing circular interpolation, 2 axes will operate at the same time. Pay attention.

(1) Available auxiliary operations are as follows.

- Speed override, Dec. stop, Emergent stop, Skip operation.

(2) The commands unavailable during circular interpolation operation are as follows.

- Position/Speed switching control, Position override, Continuous operation

(3) The parameter items operating by each axis setting are as follows.

- Software high limit, Software low limit among extended parameter

(c) Setting example of Operating data

Items	Main-axis setting	Sub-axis setting	Description
Control Method	Absolute, Circular interpolation	- *1	When executing circular interpolation with absolute coordinates, set 「Absolute, Circular interpolation」 on main. Set the coordinate of sub-axis as "Absolute" too.
Operating Method	Single, End	-	Set the method to execute circular interpolation
Target position [pls]	10000	0	Set the target position to execute on Main, Sub axis
Operation speed [pls/s]	1000	-	Circular interpolation uses the method of composition speed. Set the composition speed at the main-axis
Acc. no.	No.1	-	Set Acc. No. for acceleration (no.1 ~ no.4)
Dec. no.	No.2	-	Set Dec. No. for deceleration. (no.1 ~ no.4)
M code	0	-	When you need to execute auxiliary work based on the interpolation operation, set the M code
Dwell time	500	-	Set dwell time(ms) needed to output the positioning completion signal
Sub-axis setting	Axis2	-	Set an axis to be used as sub-axis among settable axis in operating data of main-axis
Auxiliary point	7000	-	Set the radius on main-axis
Circular interpolation mode	Radius, CW, Arc<180°	-	When using radius specified circular interpolation, set 「Radius」 on main-axis and set moving direction of arc and size of arc
Circular interpolation turns	-	-	Set the no. of turns of arc for making a circle bigger than 360°
Helical	Don't use	-	When using circular interpolation, set it to 「Don't」

- *1 : It means that it need not be set. Whatever value it is, it dose not affect circular interpolation.

Remark

(1) Radius specified circular interpolation is executed on the basis of the items set on operating data of main axis (command axis). When it is executed, only 「Target position」 among sub axis items can affect circular interpolation. In other words, whatever value is set as, it does not affect the action and no errors arise. But, coordinate setting of sub-axis control method means whether target position is absolute coordinate or incremental coordinate. So in case of circular interpolation control by absolute coordinate method, set the coordinate of sub-axis as "Absolute" too.

(2) When setting the circular interpolating auxiliary point (radius) of main-axis, it must be bigger than the half of the length between starting position and target position. When radius is smaller than the half(R) of straight, it is likely occur error. If the Radius is higher than 80% of R, circular interpolation which has middle point between starting position and goal position as center-point is executed, and if the value is lower than 80% of R, error (error code:270) arises and circular interpolation is not executed.

[Example] Axis1 is main-axis and Axis2 is sub-axis. Execute radius specified circular interpolation with incremental.

- Starting position (1000, 1000), Target position (9000, 1000), Auxiliary point (5000, 0)
Moving direction of arc : CW, Size of arc : Arc < 180°
The action is as follows in the condition above
- Setting example in XG-PM

▪ Main-axis(Axis1) Operating data

Step No.	Control method	Operation Method	Target position [pls]	Operation speed [pls/s]	Acc. No.	Dec. No.	M Code	Dwell Time	Sub-axis Setting	Auxiliary Point	Circular interpolation mode	Circular interpolation turns	Helical interpolation
1	Absolute, Circular interpolation	Single, End	9000	1000	No.1	No.1	0	100	Axis2	5000	Radius, CW, Arc<180	0	Not use

▪ Sub-axis(Axis2) Operating data

Step No.	Control method	Operation Method	Target position [pls]	Operation speed [pls/s]	Acc. No.	Dec. No.	M Code	Dwell Time	Sub-axis Setting	Auxiliary Point	Circular interpolation mode	Circular interpolation turns	Helical interpolation
1	Absolute, single axis position control	Single, End	1000	1000	No.1	No.1	0	100	Axis2	5000	Radius, CW, Arc<180	0	Not use

■ Operation pattern

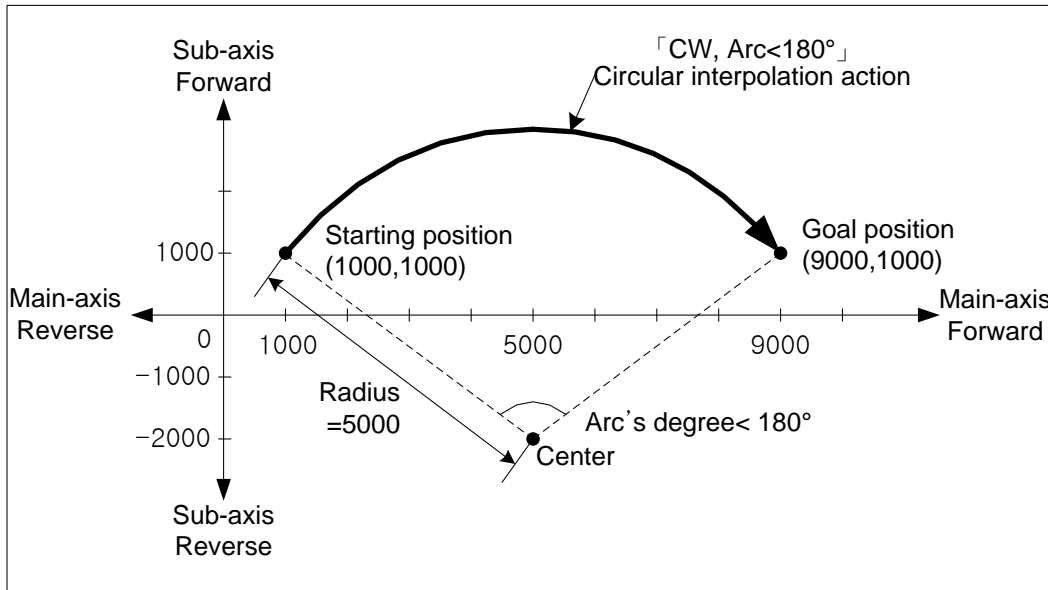

(2) Radius specified circular interpolation, incremental coordinate
 (「Incremental, Circular interpolation」)

(a) Starts operation from starting position and executes circular interpolation by the increment set on target position along the trace of the circle which has the value set on circular interpolation auxiliary point of main-axis operation data as a radius. Circular arc depends on the moving direction of 「Circular interpolation mode」 (CW, CCW) and setting of arc size(Arc<180°, Arc>=180°)

Circular interpolation mode	Description
Radius, CW, Arc<180°	Executes circular interpolation with center-point whose arc is smaller than 180° in CW direction
Radius, CW, Arc >=180°	Executes circular interpolation with center-point whose arc is bigger than 180° in CW direction
Radius, CCW, Arc<180°	Executes circular interpolation with center-point whose arc is smaller than 180° in CCW direction
Radius, CCW, Arc>=180°	Executes circular interpolation with center-point whose arc is bigger than 180° in CCW direction

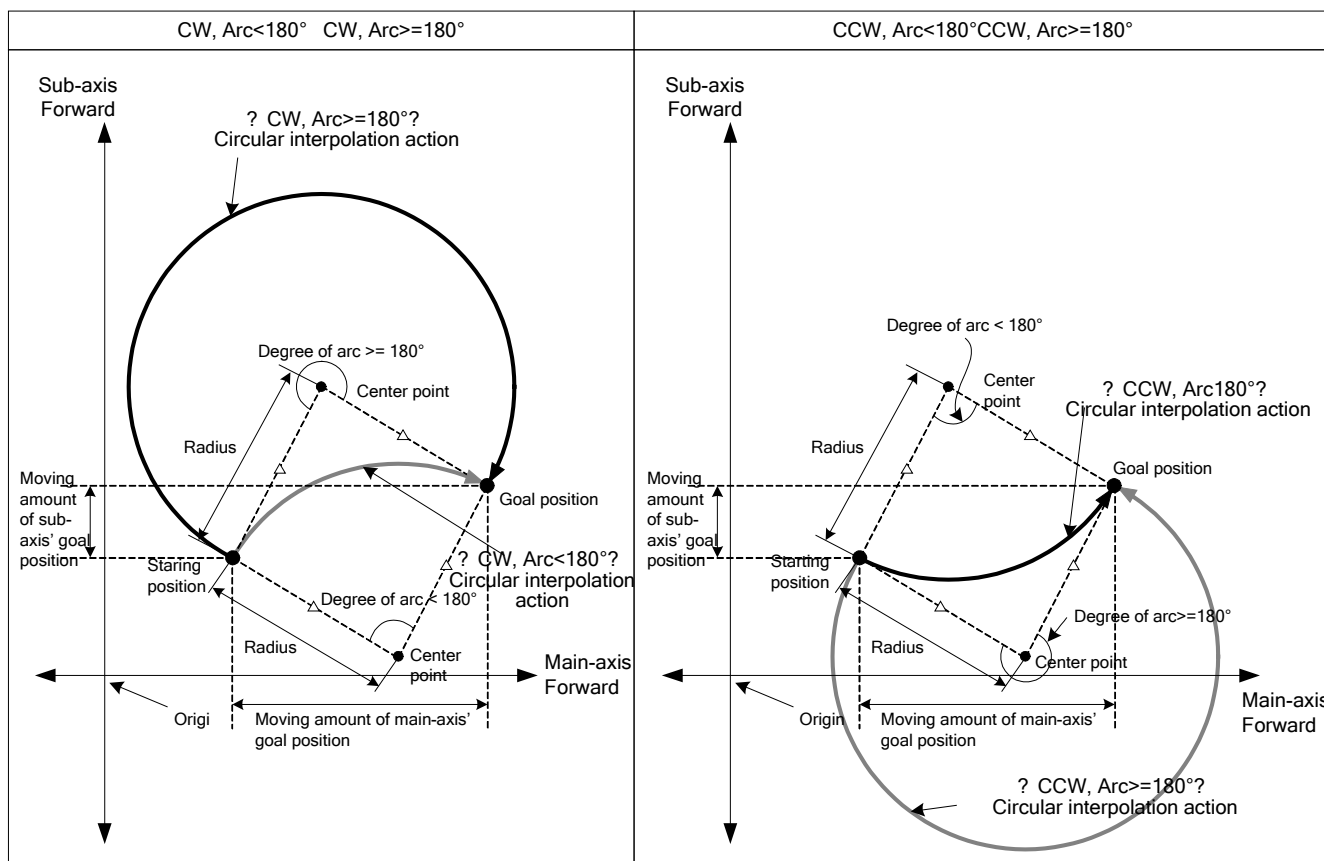

(b) Restrictions

- Radius specified circular interpolation can not draw an exact circle that the starting position and ending position are same. If you want to draw that, use center point specified circular interpolation.
- In the cases below, error would arise and circular interpolation can not be executed.
 - 「Sub-axis setting」 error (error code: 279)
 - Value of 「Sub-axis setting」 is “Axis-undecided”
 - 「Sub axis setting」 of main axis operating data is the same as main axis no.
 - 「Sub axis setting」 of main axis operating data is axis no. that is not connected to the network.
 - Control unit of main or sub axis is set as “degree”. (error code : 282(main), 283(sub))
 - Starting position and target position are same (error code: 285)
 - Radius value of circular interpolation of main-axis operating data is smaller than half of the length from starting position to target position
 - When $\text{Radius} < (R \times 0.8)$: Error (error code: 270)
 - When $(R \times 0.8) \leq \text{Radius} < R$
 - : Executes circular interpolation after reset the radius to R. In other words, executes circular interpolation by setting the center of the line from starting position to target position as center point.

(c) Setting example of Operating data

Items	Main-axis setting	Sub-axis setting	Description
Control Method	Incremental, Circular interpolation	Incremental, single-axis position control	When executing circular interpolation with incremental coordinates, set 「Incremental, Circular interpolation」 on main. Set the coordinate of sub-axis as “Incremental” too
Operating Method	Single, End	- ^{*1}	Set the method to execute circular interpolation
Target position [pls]	10000	0	Set the target position by incremental amount from current position
Operation speed [pls/s]	1000	-	Circular interpolation uses the method of composition speed. Set the composition speed at the main-axis
Acc. no.	No.1	-	Set Acc. No. for acceleration (no.1 ~ no.4)
Dec. no.	No.2	-	Set Dec. No. for deceleration. (no.1 ~ no.4)
M code	0	-	When you need to execute auxiliary work based on the interpolation operation, set the M code
Dwell time	500	-	Set dwell time(ms) needed to output the positioning completion signal
Sub-axis setting	Axis2	-	Set an axis to be used as sub-axis among settable axis in operating data of main-axis
Auxiliary point	7000	-	Set the radius on main-axis
Circular interpolation mode	Radius, CW, Arc<180°	-	When using Radius specified circular interpolation, select “Radius”
Circular interpolation Turns	-	-	Set the no. of turns of arc for making a circle bigger than 360°
Helical interpolation	Don't	-	When using circular interpolation, set it to 「Don't use」

-^{*1} : It means that it need not be set. Whatever value it is, it dose not affect circular interpolation.

Remark

(1) Radius specified circular interpolation is executed on the basis of the items set on main axis operating data. When it is executed, only 「Target position」 among sub axis items can affect circular interpolation. In other words, whatever value is set as, it does not affect the action and no errors arise. But, coordinate setting of sub-axis control method means whether target position is absolute coordinate or incremental coordinate. So in case of circular interpolation control by incremental coordinate method, set the coordinate of sub-axis as “Incremental” too.

(2) When setting the circular interpolation auxiliary point (radius) of main-axis, it must be bigger than the half of the length between starting position and goal position. When it is smaller than the (R), if the value is higher than 80% of R, circular interpolation which has middle point between starting position and target position as center-point is executed, and if the value is lower than 80% of R, error (error code:270) arises and circular interpolation is not executed.

[Example] Axis1 is main-axis and Axis2 is sub-axis. Executes Radius specified circular interpolation with incremental coordinates.

- Starting position (1000, 1000), Target position (8000, 0), Auxiliary point (5000, 0)
Moving direction of arc : CCW, Size of arc : Arc $\geq 180^\circ$
The action is as follows in the condition above

- Setting example in XG-PM
 - Main-axis(Axis1) Operating data

Step No.	Control method	Operation Method	Target position [pls]	Operation speed [pls/s]	Acc. No.	Dec. No.	M Code	Dwell Time	Sub-axis Setting	Auxiliary Point	Circular interpolation mode	Circular interpolation turns	Helical interpolation
1	Incremental, Circular interpolation	Single, End	8000	1000	No.1	No.1	0	100	Axis2	5000	Radius, CCW, Arc ≥ 180	0	Not use

- Sub-axis(Axis2) Operating data

Step No.	Control method	Operation Method	Target position [pls]	Operation speed [pls/s]	Acc. No.	Dec. No.	M Code	Dwell Time	Sub-axis Setting	Auxiliary Point	Circular interpolation mode	Circular interpolation turns	Helical interpolation
1	Incremental, single-axis position control	Single, End	1000	0	No.1	No.1	0	100	Axis2	0	Middle point	0	Not use

■ Operation pattern

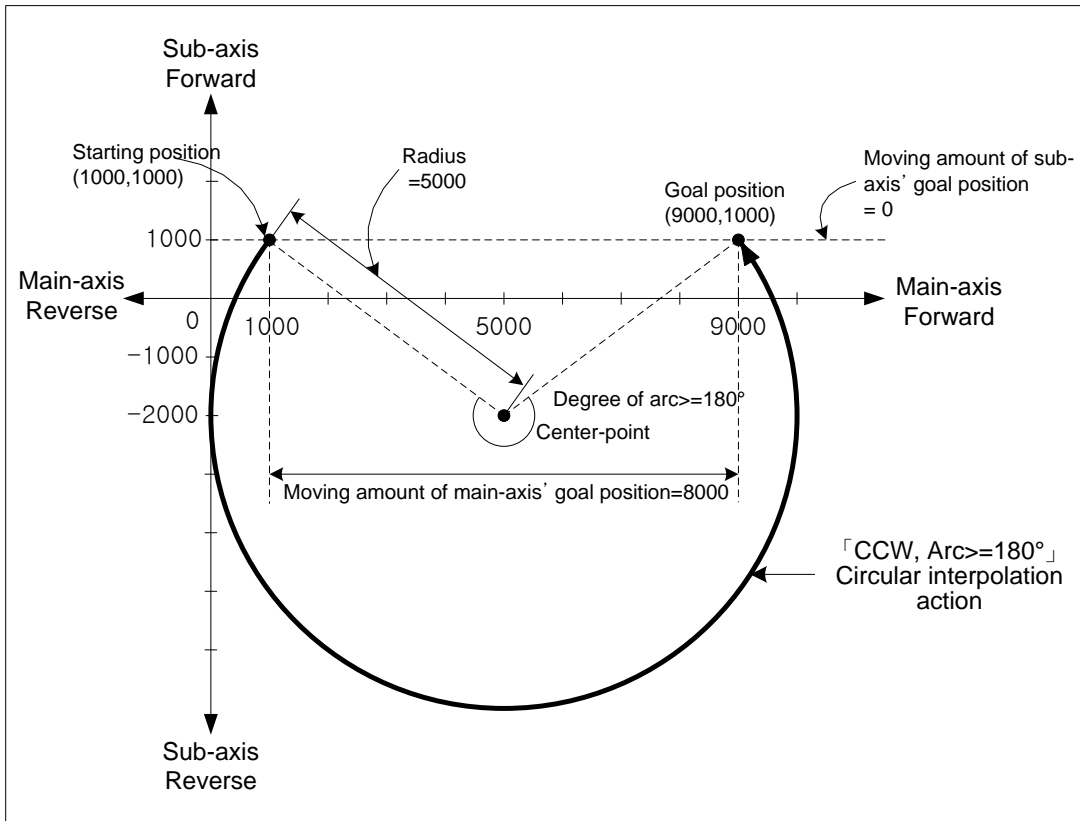

9.2.12 Helical Interpolation Control

After executed by start command (Indirect start, Synchronous start), 2 axes move along the circular arc and an axis execute linear interpolation synchronizing with circular interpolation.

It can execute helical interpolation of over 360° according to “Circular interpolation turns” setting

There is no limit to the combinations of axes and 3 axes among axis1~axis8 are used.

(1) Characteristics of control

(a) After setting operating data for circular interpolation, if you set a helical interpolation axis on the item “Helical interpolation”, the helical interpolation will be executed.

(b) The direction of circular arc depends on the target position and the mode of circular interpolation, the direction of helical axis depends on the coordinates setting and the target position.

■ In case of 「Absolute, Circular interpolation」

Starting position < Target position: Positioning operation in forward direction

Starting position > Target position: Positioning operation in reverse direction

■ In case of 「Incremental, Circular interpolation」

Positive sign (+) or No sign : Positioning operation in forward direction

Negative sign (-) : Positioning operation in reverse direction

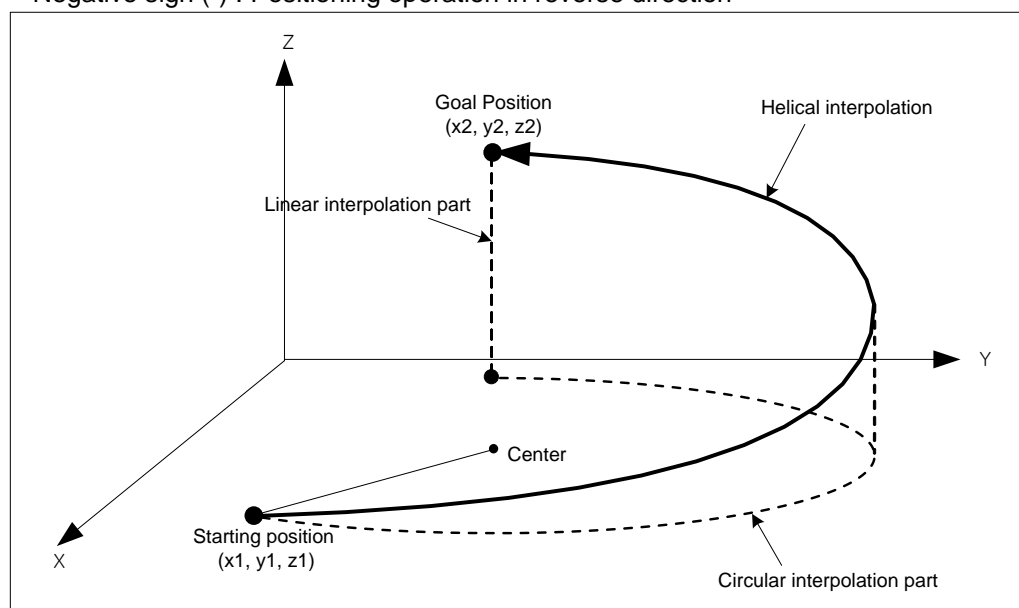

(2) Restrictions

- (a) The restrictions of helical interpolation are same as various kinds of circular interpolation depending on the mode of circular interpolation.
- (b) If you set 「Helical Interpolation」 as “Don’t use”, it will be same as the action of circular interpolation.
- (c) If you set the target position of helical interpolation axis as the same starting position, it will be same as the action of circular interpolation.

Remark

If you execute helical interpolation, 3 axes will operate at the same time. Pay attention.

- (1) Available auxiliary operations are as follows.
 - Speed override, Dec. stop, Emergent stop, Skip operation.
- (2) The commands unavailable during helical interpolation operation are as follows.
 - Position/Speed switching control, Position override, Continuous operation
- (3) The parameter items operated by each axis setting are as follows.
 - Software high limit, Software low limit among extended parameter.

(3) Example of operation data setting

Items	Main axis(axis1) Setting	Sub axis(axis2) Setting	Helical axis(axis3) setting	Description
Control method	Absolute, Circular interpolation	Absolute, single-axis position control	Absolute, single-axis position control	when executing helical interpolation, circular interpolation must be set
Operation method	Single, End	- *1	- *1	Set operation method for helical interpolation
Target position [pls]	10000	0	10000	Set the goal position on main, sub, helical axis for executing positioning.
Operation speed [pls/s]	1000	-	-	Helical interpolation uses composition speed of circular interpolation part
Acc. no.	No.1	-	-	Set Acc. No. for acceleration (no.1 ~ no.4)
Dec. no	No.2	-	-	Set Dec. No. for deceleration. (no.1 ~ no.4)
M code	0	-	-	When you need to execute auxiliary work based on the interpolation operation , set the M code
Dwell time	500	-	-	Set dwell time(ms) needed to output the positioning completion signal
Sub axis setting	Axis2	-	-	Set an axis to be used as sub-axis among settable axis in operating data of main-axis
Circular interpolation auxiliary point	5000	5000	-	Set auxiliary data of circular interpolation action
Circular interpolation mode	Middle point	-	-	Set circular interpolation mode to be used in circular action of helical interpolation
circular interpolation turns	0	-	-	Set the no. of turns of circular arc when user need to execute helical interpolation of over 360°
Helical interpolation	Axis3	-	-	Set an axis to be used as helical interpolation axis from settable axis on main axis operation data

- *1 : This item does not need to be set. Whatever it is set as, it dose not affect circular interpolation.

Remark

Helical interpolation control is executed on the basis of item set on operation data of main axis. When executing circular interpolation of helical interpolation, only "target position", "Circular interpolation auxiliary point" items of sub axis setting and "Target position" item of helical axis setting affect helical interpolation. In other words, Whatever the setting value is, it does not affect operation and cause any errors. But, coordinate setting of sub-axis control method means whether target position is absolute coordinate or incremental coordinate. So in case of circular interpolation control by absolute coordinate method, set the coordinate of sub-axis as "Absolute" too.

[Example] Executes center point - specified helical interpolation, absolute coordinates with axis1 (main), axis2 (sub) and axis3(helical).

- The action in the case (Starting point (650, 400, 0), Goal position (400, 1200, 350), Auxiliary point (800, 400)) is as follows.
- Setting example of XG-PM
 - Operation data of main axis(axis1)

Step no.	Control method	Operating method	Target position [pls]	Operating speed [pls/s]	Acc. no.	Dec. no.	M code	Dwell time	Sub axis setting	Circular interpolation auxiliary point	Circular interpolation mode	Circular interpolation turns	Helical interpolation
1	Absolute, circular interpolation	Single, End	400	1000	No.1	No.1	0	100	Axis2	800	Center point, CCW	0	Axis3

- Operation data of sub axis(axis2)

Step no.	Control method	Operating method	Target position [pls]	Operating speed [pls/s]	Acc. no.	Dec. no.	M code	Dwell time	Sub axis setting	circular interpolation auxiliary point	Circular interpolation mode	Circular interpolation turns	Helical interpolation
1	Absolute, single axis position control	Single, End	1200	0	No.1	No.1	0	100	-	400	Middle point	0	Not use

- Operation data of helical axis(axis3)

Step no.	Control method	Operating method	Goal position [pls]	Operating speed [pls/s]	Acc. no.	Dec. no.	M code	Dwell time	Sub axis setting	circular interpolation auxiliary point	Circular interpolation mode	Circular interpolation turns	Helical interpolation
1	Absolute, single axis position control	Single, End	350	0	No.1	No.1	0	100	-	0	Middle point	0	Not use

■ Operating pattern

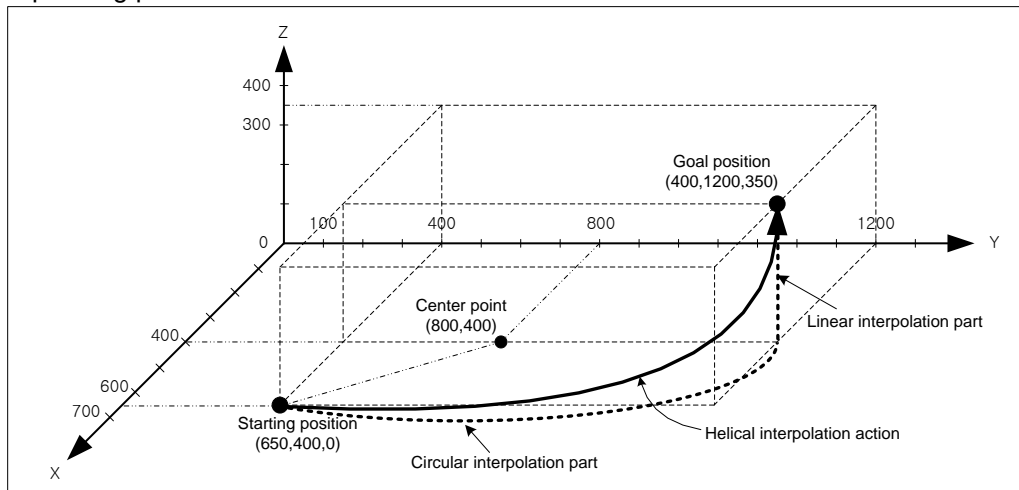

9.2.13 Ellipse Interpolation Control

Executes ellipse interpolation by using circular interpolation operation data set on the 2 axes, and ellipse rate and moving angle, auxiliary data of 「Ellipse interpolation」 command.

There is no limit to the combinations of axes and 2 axes among axis1~axis8 are used.

(1) Characteristics of Control

(a) For ellipse interpolation, set the operation data as “center point - specified circular interpolation” and set the rate and size of ellipse by auxiliary data of “ellipse interpolation command”

Auxiliary data	Setting value	Description
Ratio of ellipse (%)	0 ~ 65535	Set the ratio of horizontal axis and vertical axis (1 = 0.01%)
Size(Degree) of ellipse	0 ~ 65535	Set the ellipse's moving degree (1 = 0.1°)

(b) Moving direction of ellipse is decided by the direction set by “circular interpolation mode” of operation data.

- 「Center point, CW」 - Executes ellipse interpolation in clockwise.
- 「Center point, CCW」 - Executes ellipse interpolation in counterclockwise.

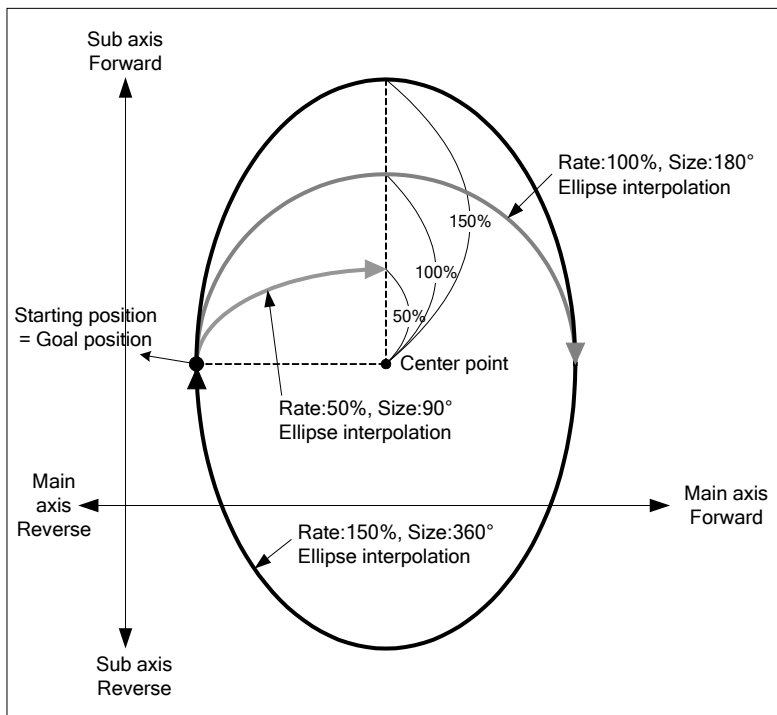

(c) Starting position and target position must be same when executing ellipse interpolation.

(d) When executing ellipse interpolation, the radius changes continuously and composing speed also changes depending on the ratio of ellipse. When the ratio of ellipse is bigger than 100%, operating speed of sub axis and composing speed get faster. So it calls user's attention. Sub axis of ellipse interpolation is not limited by "speed limit", so you set the operating speed not to exceed the speed limit.

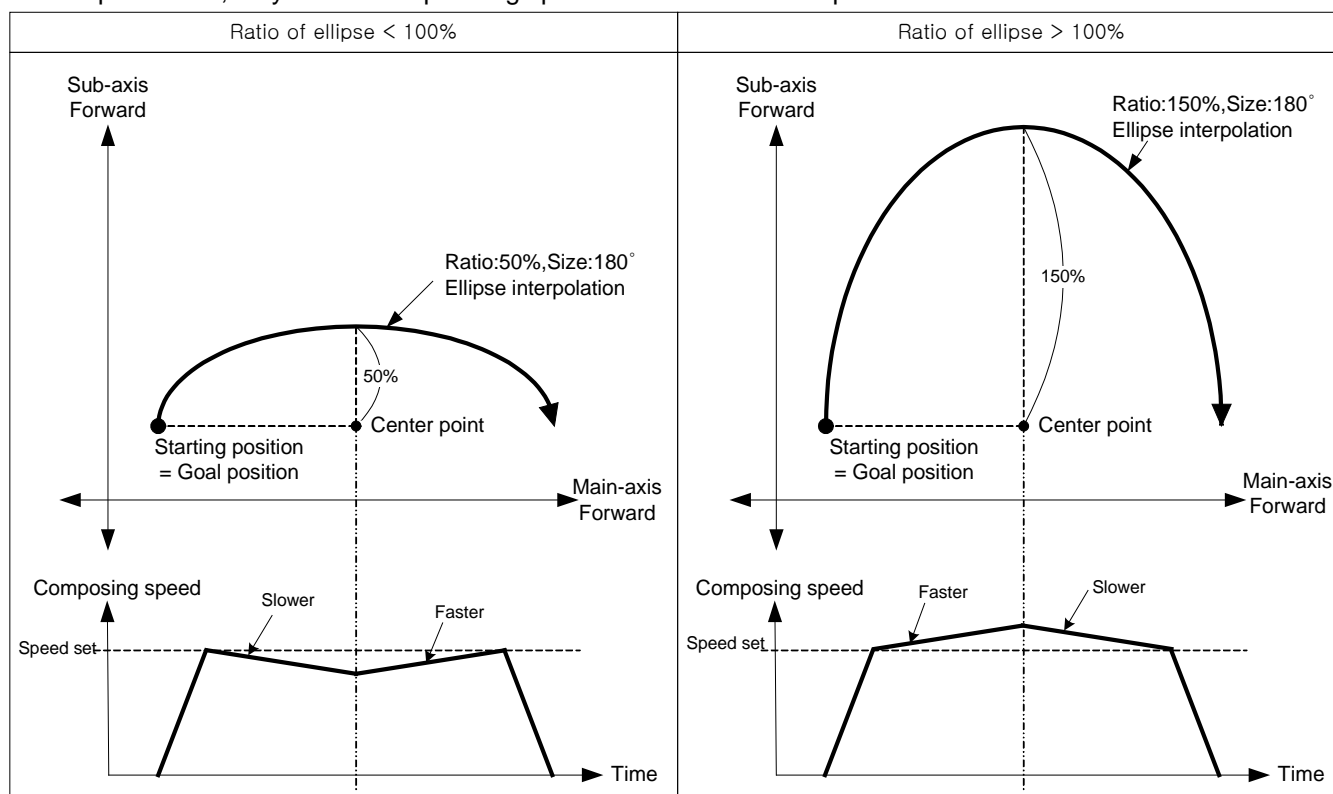

(2) Restrictions

(a) Ellipse interpolation can not be executed in the case below.

- 「Sub-axis setting」 Error (error code : 547)
 - The value of sub-axis setting of main axis operating data is "Axis-undecided".
 - The value of sub-axis setting of main axis operating data is same as the no. of main-axis.
 - The value of sub-axis setting of main axis operating data is axis no. that is not connected to the network.
 - An axis of helical interpolation is set.
 - Control unit of main or sub axis is set as "degree". (error code : 551(main), 552(sub))
 - The center point designated as auxiliary point is the same as starting position or goal position. (error code : 553)
 - The radius of circular arc exceeds 2147483647pls. (error code : 554)
 - The operating method is "continuous" or "Keep". (error code : 556)
- If user executes ellipse interpolation, End operation must be set before use.
- Starting position and Goal position are different. (error code : 558)
 - Size of circular arc (Moving degree) is 0. (error code : 559)

Remark

2 axes will operate at the same time. So pay attention.

1. Auxiliary operations available are as follows.
 - Speed override, Dec. stop, Emergent stop, Skip operation
2. The commands unavailable during ellipse interpolation operation are as follows.
 - Position/Speed switching control, Position override, Continuous operation
3. Parameter items operated by setting value of each axis are as follows.
 - Software high limit, Software low limit among extended parameter.

(3) Setting example of operation data

Items	Main-axis setting	Sub-axis setting	Description
Control Method	Absolute, Circular interpolation	Absolute, single-axis position control	Set circular interpolation when executing ellipse interpolation
Operating Method	Single, End	-	“End” must be set when using ellipse interpolation
Target position[pls]	10000	0	Set the goal position to execute on Main, Sub axis
Operation speed[pls/s]	1000	-	Designate composing speed for circular interpolation part in ellipse interpolation
Acc. no.	No.1	-	Set Acc. No. for acceleration (no.1 ~ no.4)
Dec. no.	No.2	-	Set Dec. No. for deceleration. (no.1 ~ no.4)
M code	0	-	When you need to execute auxiliary work based on the interpolation operation, set the M code
Dwell time	500	-	Set dwell time(ms) needed to output the positioning completion signal
Sub-axis setting	Axis2	-	Set an axis to be used as sub-axis among settable axis in operating data of main-axis
Auxiliary point	5000	5000	Set the center point of ellipse
Circular interpolation	Center point, CW	-	Center point must be set when using ellipse interpolation
Circular interpolation turns	-	-	The no. of turns is not operated in ellipse interpolation
Helical interpolation	Don't use	-	Set axis of helical interpolation as “Don't Use” when using ellipse interpolation

- *1 : It means that no need to be set. Whatever value it is, it dose not affect circular interpolation.

Remark

Ellipse interpolation control is executed based on the operating data of main-axis. When executing ellipse interpolation, only 「Target position」 and 「circular interpolation auxiliary point 」 affect the operation of ellipse interpolation. In other words, whatever value is set, it does not affect operation and no errors arise. But, coordinate setting of sub-axis control method means whether target position is absolute coordinate or incremental coordinate. So in case of circular interpolation control by absolute coordinate method, set the coordinate of sub-axis as “Absolute” too.

[Emple] Executes ellipse interpolation with 20% of ellipse ratio, 360°of movement degree and incremental coordinate

- Starting position (100, 100),
Setting of goal position : (0, 0)
Setting of auxiliary point : (500, 200)
Direction of operation : CW

■ Example setting in XG-PM

▪ Operation data of Main-axis(axis1)

Step no.	Control method	Operating method	Target position [pls]	Operating speed [pls/s]	Acc. No.	Dec. No.	M code	Dwell Time	Setting Sub axis	circular interpolation auxiliary point	Circular interpolation mode	Circular interpolation turns	Helical interpolation
1	Incremental, circular interpolation	Single, End	0	1000	No.1	No.1	0	100	Axis2	500	Center point, CW	0	Don't use

▪ Operation data of Sub-axis(axis2)

Step no.	Control method	Operating method	Target position [pls]	Operating speed [pls/s]	Acc. No.	Dec. No.	M code	Dwell Time	Setting Sub axis	circular interpolation auxiliary point	Circular interpolation mode	Circular interpolation turns	Helical interpolation
1	Incremental, single-axis position control	Single, End	0	0	No.1	No.1	0	0	None	200	Middle point	0	Don't use

■ Operating pattern

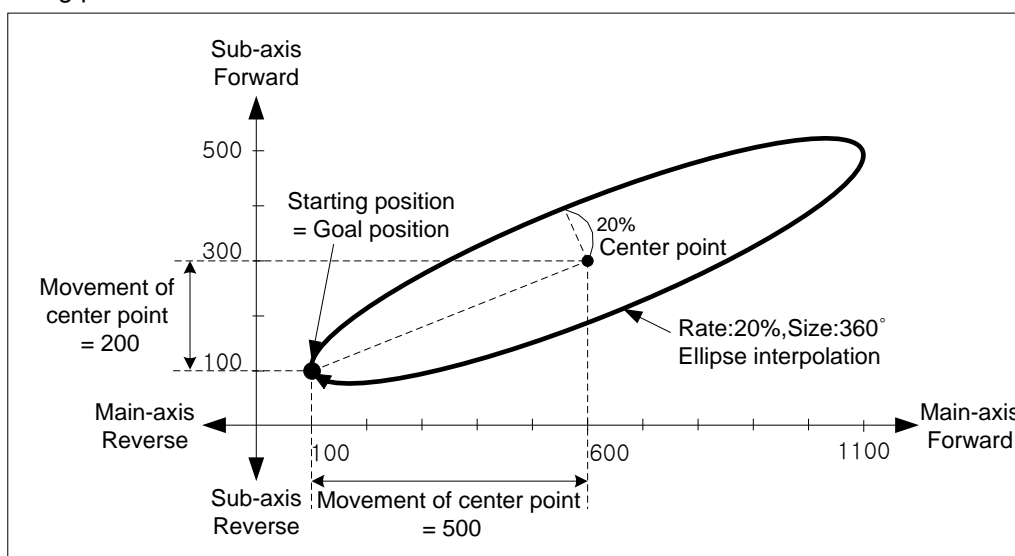

Remark

- (1) If the degree of ellipse is not 360°, the target position and actual position after stop are not same.
- (2) If the ratio of ellipse is 0%, the trace of ellipse interpolation is shown as straight line. Ratio of ellipse need to be set to above 0.

9.2.14 Speed/Position Switching Control

The setting axis carries out the speed control and is switched from speed control to position control when speed/position switching signal is entered to the positioning module inside or outside, and then carries out the positioning according to the target position.

(1) Characteristics of Control

- (a) Set control method of operating data as “Single-axis speed control” and execute 「Speed/Position Switching」 command during speed control operation.
- (b) Direction of movement depends on the sign of value.
 - Forward: The position value is Positive(+)
 - Reverse: The position value is Negative(-)
- (c) On order to use the external command as “Speed/position switching signal”, you have to set “External command selection” item and “External command” item of extended parameter.

Item	Setting value	Description
External command selection	0 : External speed/position control switching	In case there is external command input, it is used as “External speed/position control switching” signal
	1 : External stop command	In case there is external command input, it is used as “External stop command” signal
External command	0: Disable	External command signal is ignored and it does not affect operation
	1: Enable	In case there is external command input, it operates according to “External command selection” item.

- (d) In case of speed/position switching, this item determines whether to consider the set value as absolute coordinate value or incremental coordinate value.

Item	Setting value	Description
Speed/position switching coordinate	0 : incremental	The object moves as far as the set value from the position where command is executed.
	1 : absolute	It considers the set value as the absolute coordinate value and the object moves to the set absolute position.

- (e) The coordinate setting specified when starting the speed control doesn't affect the operation. Namely, operation of “ABS, single-axis speed control” is same as that of “INC, single-axis speed control”.

(2) Operation timing

1) Speed/Position switching coordinate = 0: incremental

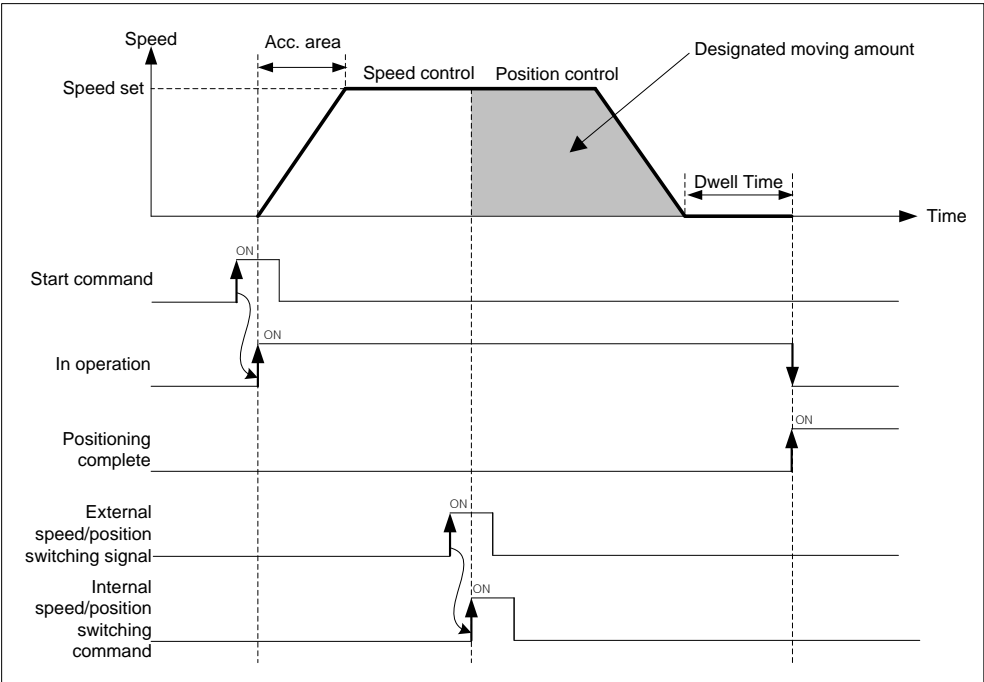

2) Speed/Position switching coordinate = 1: absolute

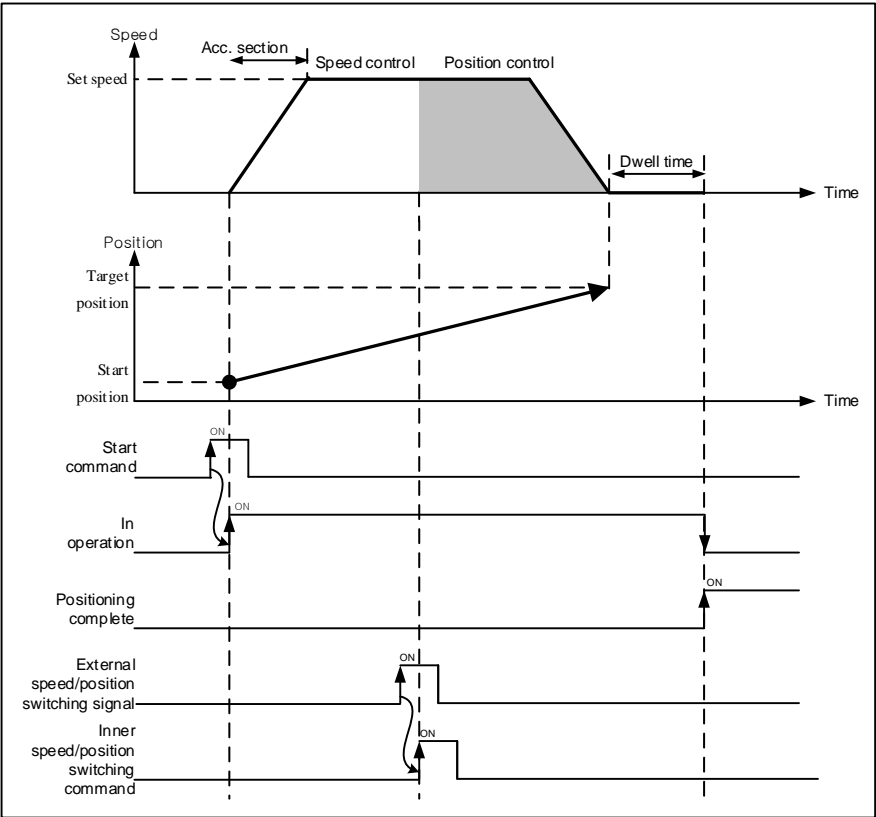

(3) Restrictions

- (a) Operation pattern of speed control has to be set as "End" or "Keep". If that is set as "Continuous", error (error code:236) arises and speed control can not be executed.
- (b) In case speed/position switching coordinate = ""0: incremental", if target position of operation data or Direct start command is 0, speed/position switching command is not executed and error (error code: 304) appears. At this time, it keeps speed control.

(4) Setting example of operation data

Items	Setting value	Description
Control method	Absolute, single-axis speed control	When executing speed/position switching control, set single-axis speed control
Operating method	Single, End	When executing speed/position switching control, set "End" or "Keep"
Target position [pls]	10000	Set the position value to be used for positioning after speed/position switching command.
Operating speed [pls/s]	1000	Set the operating speed of speed/position switching control
Acc. no.	No.1	Set acc. no. used in acceleration (no.1~4)
Dec. no.	No.2	Set dec. no. used in deceleration (no.1~4)
M code	0	Set when you need to execute another auxiliary work based on the speed/position switching control
Dwell time	500	Set dwell time(ms) needed to output the positioning completion signal after positioning

Remark

In case speed/position switching coordinate is 1: ABS and target position is smaller than current position, its operation is different according to "infinite running repeat" setting.

- 1. When infinite running repeat = 0: disable
 - After dec. stop, it goes to the opposite direction and gets to the target position.

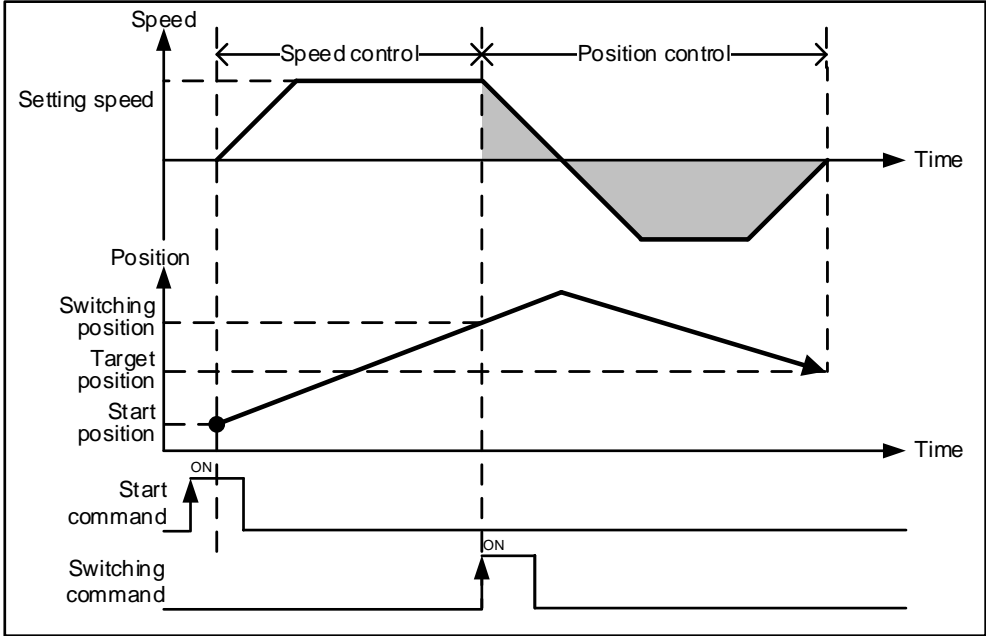

- 2. When infinite running repeat = 0: enable
 - It keeps its direction and goes to the target position within infinite running position

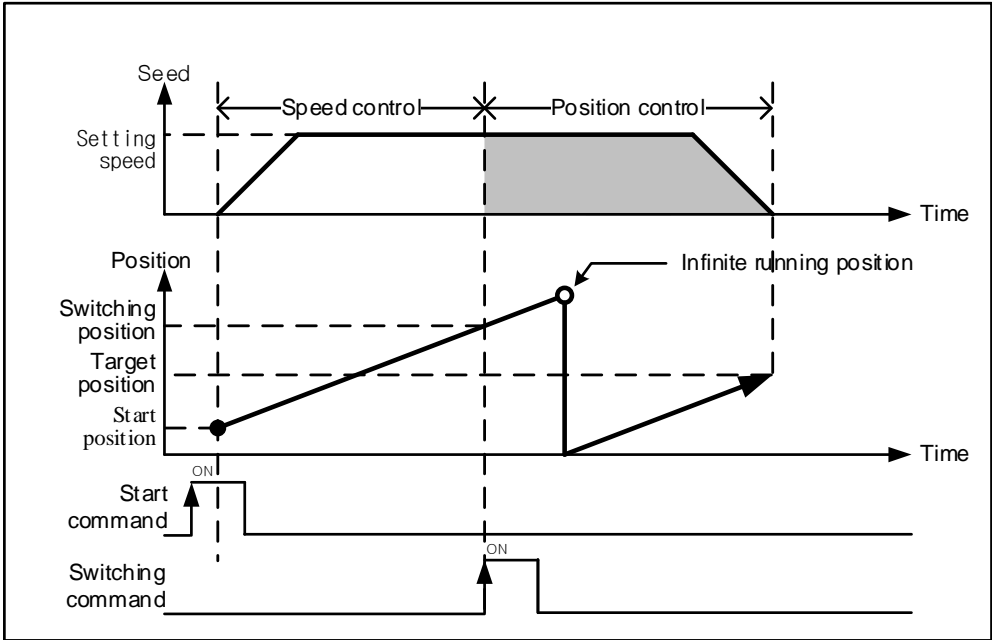

9.2.15 Position specified Speed/Position Switching Control

The setting axis carries out the speed control and is switched from speed control to position control when position specified speed/position switching signal is entered to the positioning module, and then carries out the positioning according to target position.

(1) Characteristics of Control

- (a) Set control method of operating data as “Single axis speed control” and execute 「Position specified Speed/Position Switching」 during speed control operation.
- (b) In case of speed/position switching, this determines whether to consider the set position value as absolute coordinate value or incremental coordinate value.

Item	Setting value	Description
Speed/position switching coordinate	0 : incremental	The object moves as far as the set value from the position where command is executed.
	1 : absolute	It considers the set value as the absolute coordinate value and the object moves to the set absolute position.

- (c) In speed/position switching control, the value of coordinate specified when starting speed control has no affection. In other words, action of “Absolute, single axis speed control” and “incremental, single axis speed control” are same.
- (d) In Position specified speed/position control, a target position set in the operation data or Direct start command is ignored and it moves according to target position operand of 「Position specified speed/position switching control」 command

(2) Operation timing

1) Speed/Position switching coordinate = 0: incremental

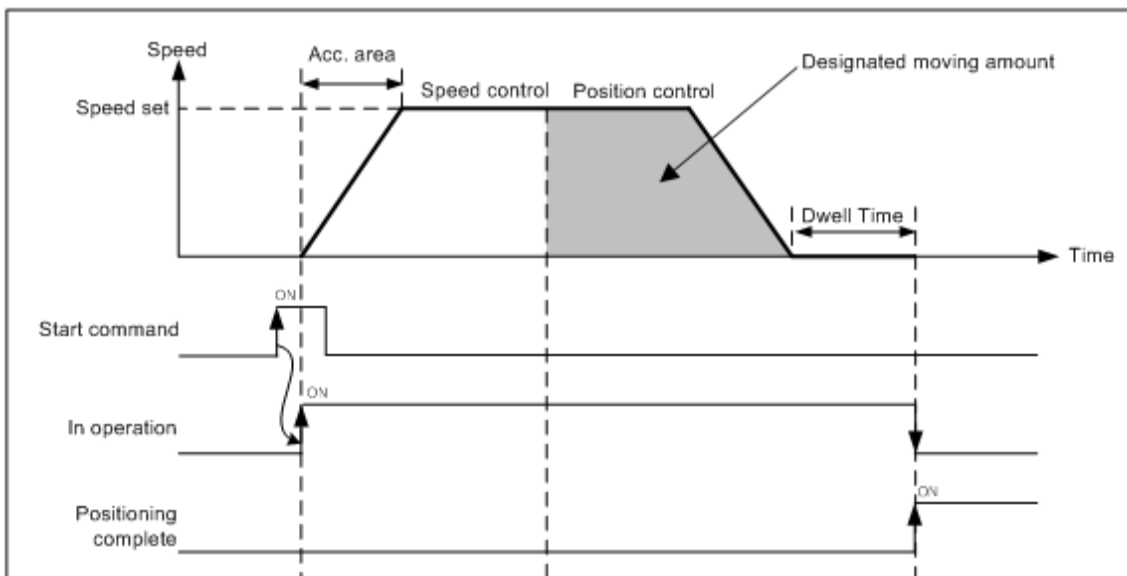

2) Speed/Position switching coordinate = 1: absolute

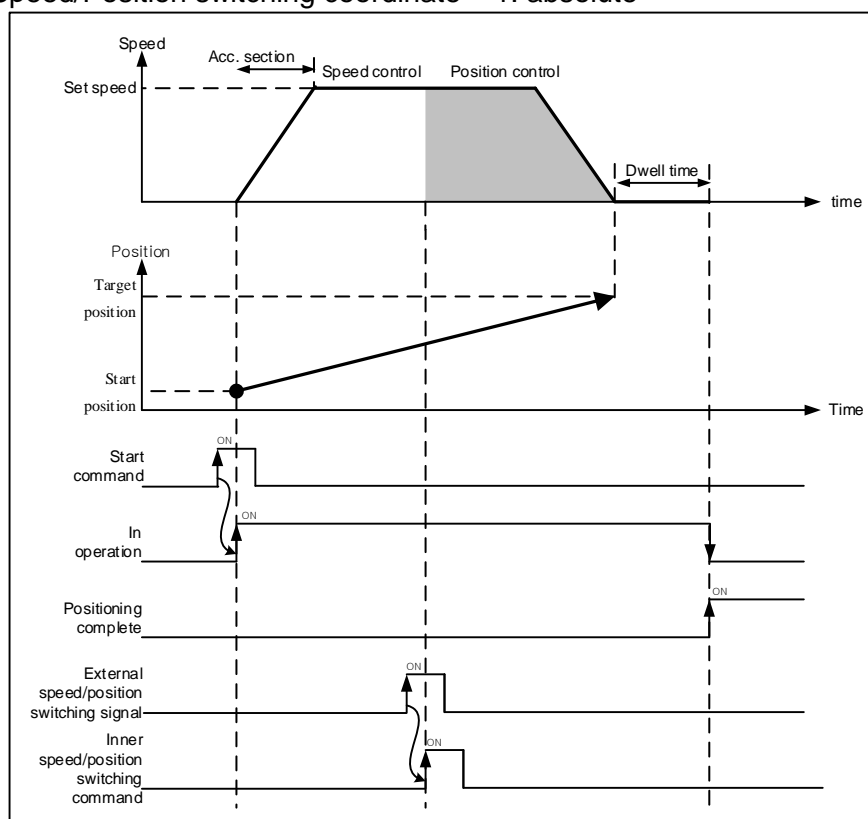

(3) Restrictions

- Operation pattern of speed control has to be set as "End" or "Keep". If that is set as "Continuous", error (error code:236) arises and speed control can not be executed.
- If the value of target position is 0, position specified speed/position switching command can not be executed. In this case, it continues to operate with speed control.
- In case infinite running repeat = 1: Enable and speed/position switching coordinate = 1: Absolute, if you set the position value which make the object go to the opposite direction as position operand, error (error code 306) appears and it keep its speed control.

(4) Setting example of operation data

Items	Setting value	Description
Control method	Absolute, Single-axis speed control	When executing speed/position switching control, set single axis speed control
Operating method	Single, End	When executing speed/position switching control, set "End" or "Keep"
Target position [pls]	10000	Set the position value to be used for positioning after speed/position switching command. In case of position specified speed/position switching command, the target position set here is ignored and the target value set as the operand of the position specified speed/position switching command is used for positioning
Operating speed [pls/s]	1000	Set the operating speed of speed/position switching control
Acc. no.	No1	Set acc. no. used in acceleration (no.1~4)
Dec. no.	No.2	Set dec. no. used in deceleration (no.1~4)
M code	0	Set when you need to execute another auxiliary work based on the position specified speed/position switching control.
Dwell time	500	Set dwell time(ms) needed to output the positioning completion signal after positioning.

Remark

In case speed/position switching coordinate is 1: ABS and target position is smaller than current position, its operation is different according to "infinite running repeat" setting.

- 1. When infinite running repeat = 0: disable
 - After dec. stop, it goes to the opposite direction and gets to the target position.

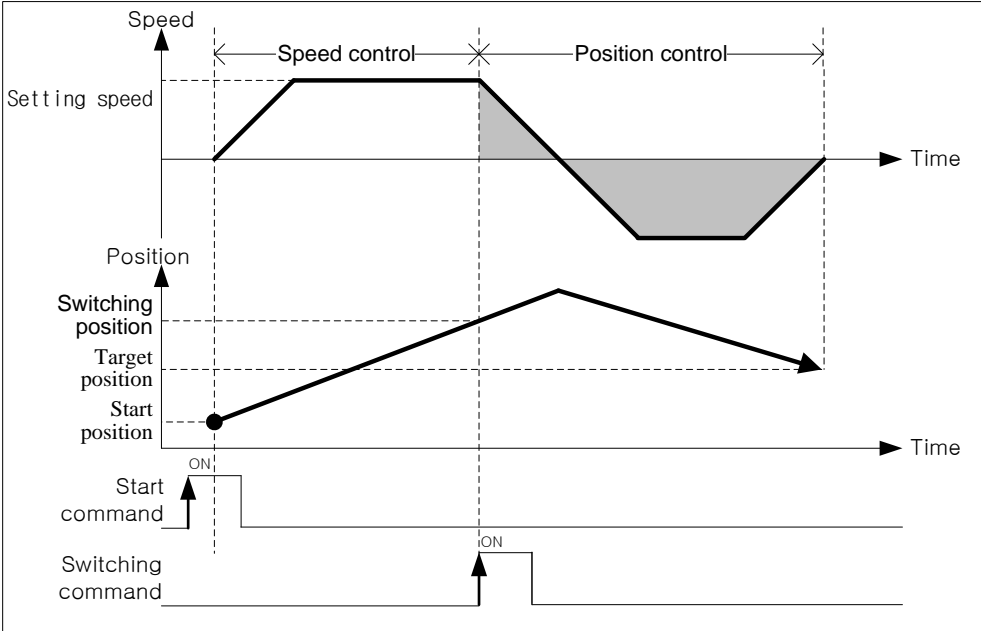

- 2. When infinite running repeat = 0: enable
 - It keeps its direction and goes to the target position within infinite running position

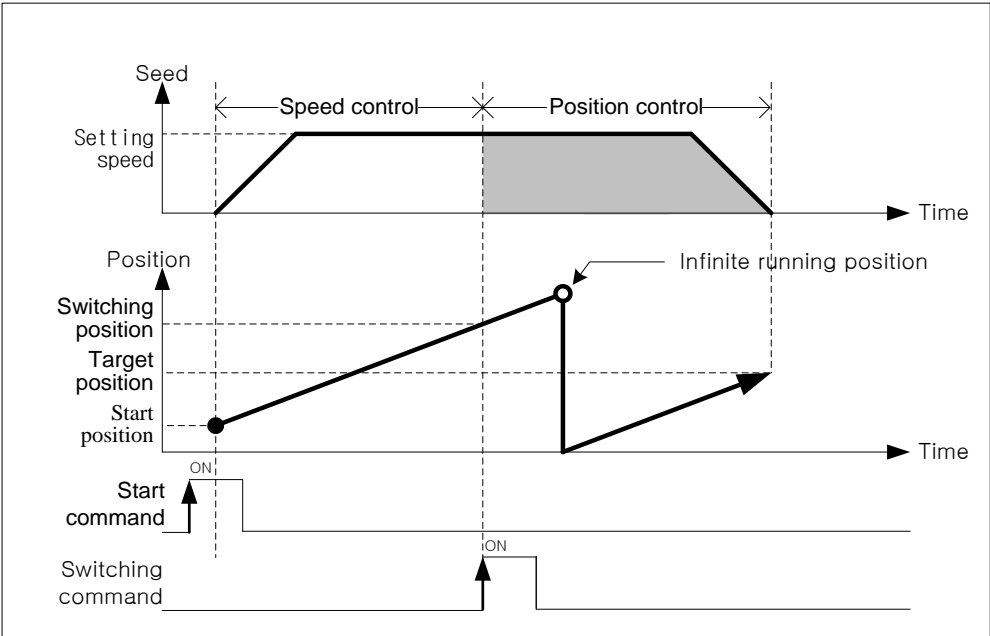

9.2.16 Position/Speed Switching Control

The setting axis carries out the position control and is switched from position control to speed control when position/speed switching signal is entered to the positioning module inside, and then it stops by “Dec. stop” or “SKIP operation”, or continues next operation.

(1) Characteristics of Control

- (a) Set control method of operating data as “Single axis position control” and change position control to speed control with 「Position/Speed Switching」 command
- (b) Direction of movement depends on the sign of value and coordinates
 - 「Absolute, Single axis position control」
 - Starting position < Target position : Positioning in forward direction
 - Starting position > Target position : Positioning in reverse direction
 - 「Incremental, Single axis position control」
 - The value of target position has positive sign (+) : Positioning in forward direction
 - The value of target position has negative sign (-) : Positioning in reverse direction

(2) Operating timing

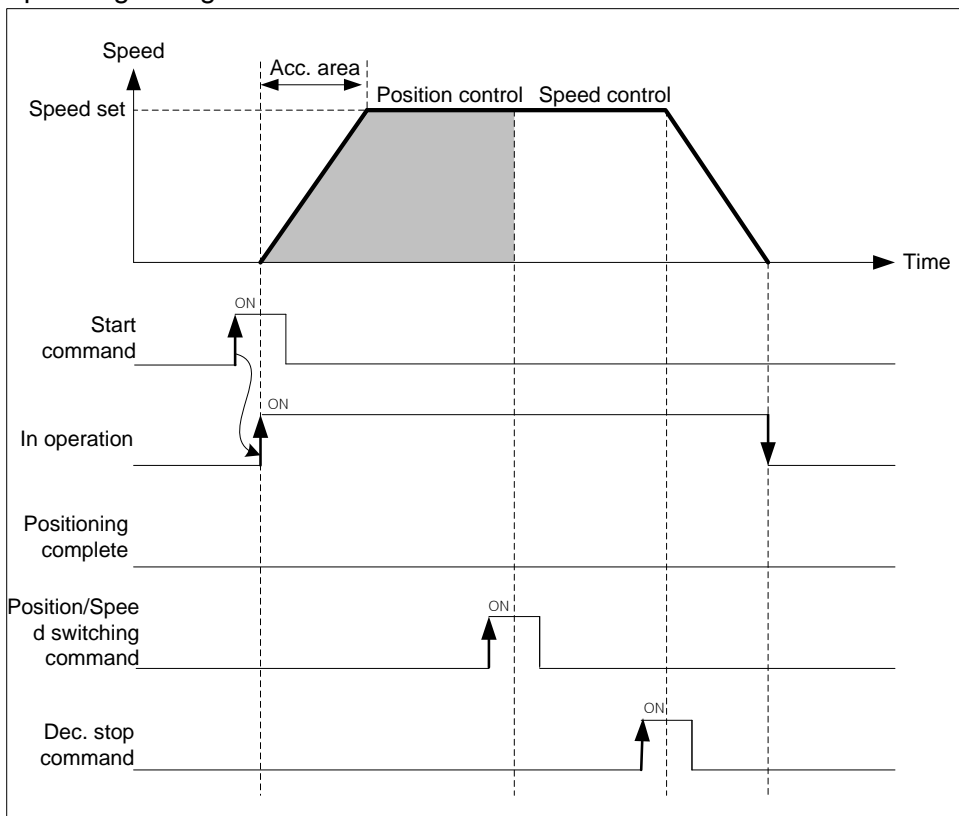

(3) Restrictions

- (a) If position/speed switching command is not inputted before getting to the target position, it stops and finishes the positioning.
- (b) After position/speed switching, software upper/lower limit check during speed control depends on “Software upper/lower limit detect” of extended parameter.

Items	Setting value	Description
Software upper/lower limit detect	0 : Don't detect	Doesn't execute checking for software upper/lower limit during speed control
	1 : Detect	Executes checking for software upper/lower limit during speed control

(4) Setting example of operation data

Items	Setting value	Description
Control method	Absolute, Single axis speed control	When executing position/speed switching control, set single-axis speed control
Operating method	Single, End	Set operating method for position control
Target position [pls]	10000	Set the value of target position for position control
Operating speed [pls/s]	1000	Set the operating speed of position/speed switching control
Acc. no.	No.1	Set acc. no. used in acceleration (no.1~4)
Dec. no.	No.2	Set dec. no. used in deceleration (no.1~4)
M code	0	Set when you need to execute another auxiliary work based on the position/speed switching control
Dwell time	500	Set dwell time(ms) needed to output the positioning completion signal after positioning

9.2.17 Position/Torque Switching Control

The setting axis t carries out the position control and is switched from position control to torque control when position/torque switching signal is entered to the positioning module inside, and then it stops by “Dec. stop” or “SKIP operation”, or continues next operation.

(1) Characteristics of Control

- (a) Set control method of operating data as “single-axis position control” and change position control to torque control with 「Position/Torque Switching」 command
- (b) Direction of movement depends on the sign of torque value, auxiliary data of position/torque switching command
 - When torque value is positive value (+) : Positioning in forward direction
 - When torque value is negative value (-) : Positioning in reverse direction

(2) Operating timing

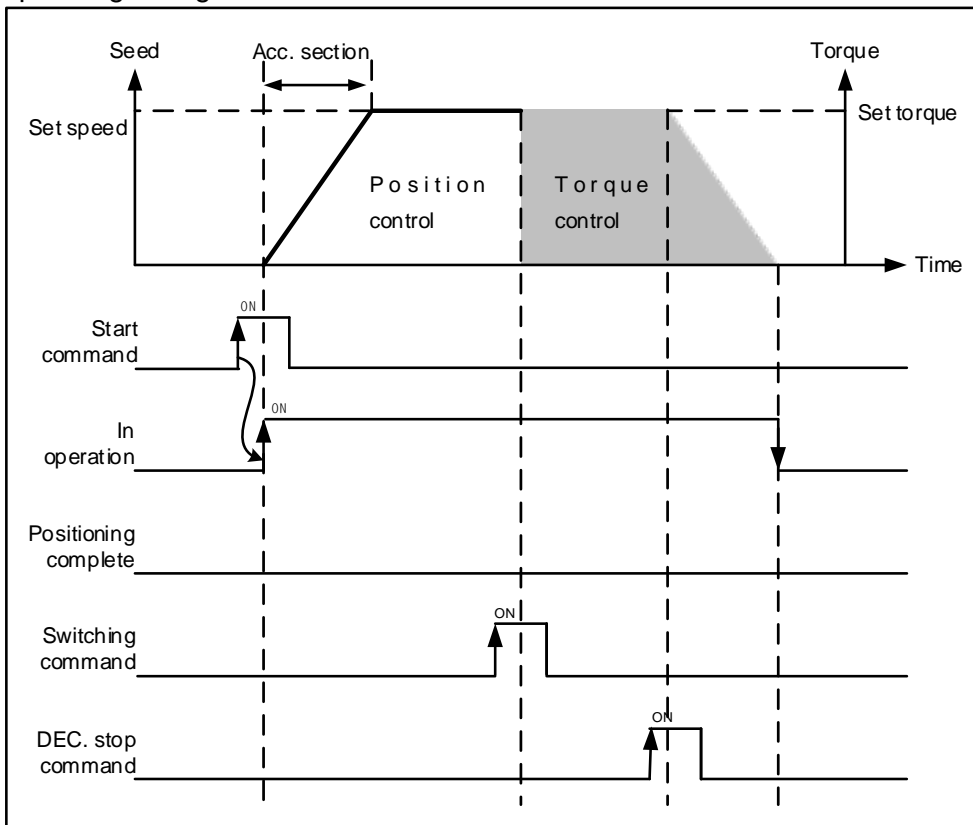

(3) Restrictions

- (a) If there is no position/torque switching command input until the object gets to the target position, it slows down and stops. Then positioning is complete.

(4) Setting example of operation data

Setting Items	Setting value	Description
Control method	Absolute, Single axis position control	When executing position/torque switching control, set single axis position control
Operating method	Single, End	Set operating method for position control
Target position [pls]	10000	Set the value of target position for position control
Operating speed [pls/s]	1000	Set the operating speed of position/torque switching control
Acc. no.	No.1	Set acc. no. used in acceleration (no.1~4)
Dec. no.	No.2	Set dec. no. used in deceleration (no.1~4)
M code	0	Set when you need to execute another auxiliary work based on the position/torque switching control
Dwell time	500	Set dwell time(ms) needed to output the positioning completion signal after positioning

9.2.18 Start of Positioning

When it stops by stop factor during operation, it can execute positioning again by start. There are general start, Simultaneous start, and point operation in start. When executing start, "In operation" signal have to be "OFF".

(1) Direct start

(a) Does not use operation data, directly inputs positioning data and performs positioning control.

(b) Setting auxiliary data of direct start.

Setting item	Contents
Target position	Set target position of control.
Operating speed	Set operating speed of control.
Dwell time	Set dwell time(ms) needed to output the positioning completion signal after positioning (0~65535)
M code	Set when you need to execute another auxiliary work based on the operation (0~65535)
Acceleration time No.	Set acceleration number for acceleration. (No.1 ~ No.4)
Deceleration time No.	Set reduction number for deceleration. (No.1 ~ No.4)
Coordinate	Set coordinate of target position.(absolute, incremental)
Control method	Set type of control (0:Position control, 1:Speed control, 2:Feed control, 3: Shortest distance control)

Remark

Direct start only can be used when it is single -axis operation. In case of Interpolation operation, use indirect start.

(2) Indirect Start

(a) Starts positioning control by designating step number of operation data saved in positioning module.

(b) Setting auxiliary data of indirect start

Setting item	Contents
Operation step	Set step number of operation data what you want to operate. (0 or 1 ~ 400)

Remark

If you set '0' as operation step of Indirect start and carry out command of indirect start, it starts operation step saved in the current step number.

(3) Simultaneous start

- (a) According to axis information and step setting, it starts positioning operation data of 2-axis ~8-axis simultaneously.
- (b) When you input the stop command, only corresponding axis stops. If you input the start command again, in case Simultaneous start setting step number is current operation step, it starts positioning operation according to incremental coordinate, absolute coordinate.

(c) Condition

In these cases, it can not operate all of the axes set on simultaneous start, because of error.

- When error occurs in operation data of any one axis among simultaneous start setting axes.
 - Outputs error code to the corresponding axis
 - Outputs error code: 297 to the axis where Simultaneous start command is executed.
 - All axes set by Simultaneous start don't start.
- When setting of simultaneous start command axis is wrong. (Error code : 296)
 - Only set command axis (You have to set more than 2 axes.)
 - There is an axis not being connected to the network among setting axes.
 - When there is linear interpolation or circular interpolation among position data of setting axes, the axis same as simultaneous setting axis is included in sub-axis of corresponding position data

[Example] Executes Simultaneous start of axis 1, axis 2 and axis 3 with the follow settings;

- Current position of axis 1: 0, Operation step: 1
Current position of axis 2: 0, Operation step: 3
Current position of axis 3: 0, Operation step: 10

■ Example of setting XG-PM

- Operation data of axis 1

Step No.	Control method	Operation method	Target position [pls]	Operation speed [pls/s]	Acc. No.	Dec. No.	M code	Dwell time
1	Absolute, single-axis position control	Single, Continuous	1000	1000	1	1	0	0
2	Absolute, single-axis position control	Single, End	1800	800	1	1	0	100

- Operation data of axis 2

Step No.	Control method	Operation method	Target position [pls]	Operation speed [pls/s]	Acc. No.	Dec. No.	M code	Dwell time
3	Absolute, single-axis position control	Single, End	900	500	2	2	0	0

- Operation data of axis 3

Step No.	Control method	Operation method	Target position [pls]	Operation speed [pls/s]	Acc. No.	Dec. No.	M code	Dwell time
10	Absolute, single-axis speed control	Single, End	1000	300	3	3	0	100

■ Operation pattern

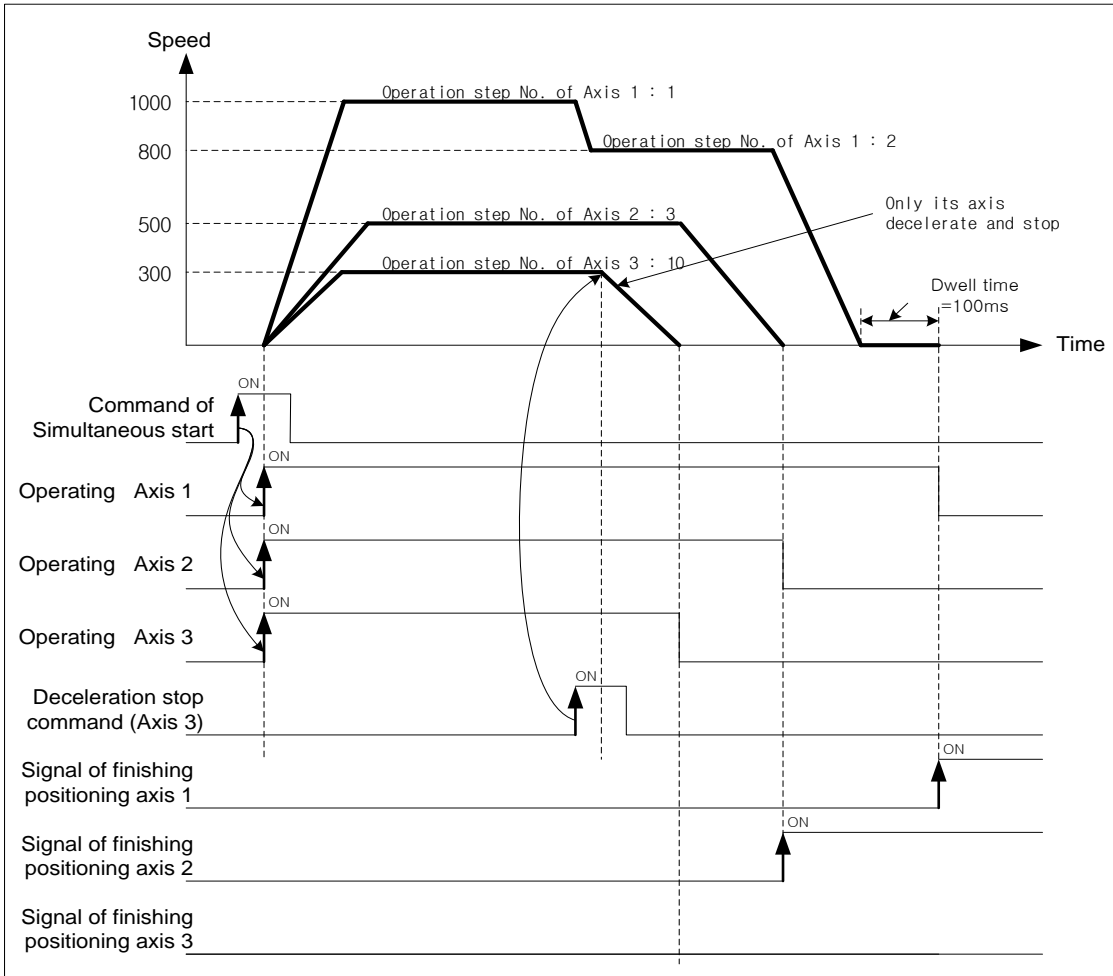

(4) Point operation

- (a) Point operation is positioning operation executing operation data of user-specified step number sequentially with one time start command. That is also known as PTP (Point To Point) start.
- (b) You can specify up to 20 steps for point operation.
- (c) Executes Point operation as much as the set point number from the set step (Point 1) regardless of operation mode such as End, Keep, continuous. In case of Keep or Continuous operation mode, specify the step which starts first.

[Example] Point operation of axis 1 is as follows;

- The number of point operation: 4
 Point operation step No. : 1, 2, 10, 20
 Current position of Axis 1 : 0
- Example of setting XG-PM

Step No.	Control method	Operation method	Target position [pls]	Operation speed [pls/s]	Acc. No.	Dec. No.	M code	Dwell time
1	Absolute, single axis position control	Single, End	1000	1000	1	1	0	20
2	Absolute, single axis position control	Single, End	3000	2000	1	1	0	20
10	Absolute, single axis position control	Single, Keep	6000	3000	1	1	0	20
11	Absolute, single axis position control	Single, Keep	10000	4000	1	1	0	20
12	Absolute, single axis position control	Single, Keep	15000	5000	1	1	0	20
13	Absolute, single axis position control	Single, End	25000	6000	1	1	0	20
20	Absolute, single axis position control	Single, Continue	45000	7000	1	1	0	0
21	Absolute, single axis position control	Single, Continue	75000	8000	1	1	0	0
22	Absolute, single axis position control	Repeat, End	0	9000	1	1	0	0

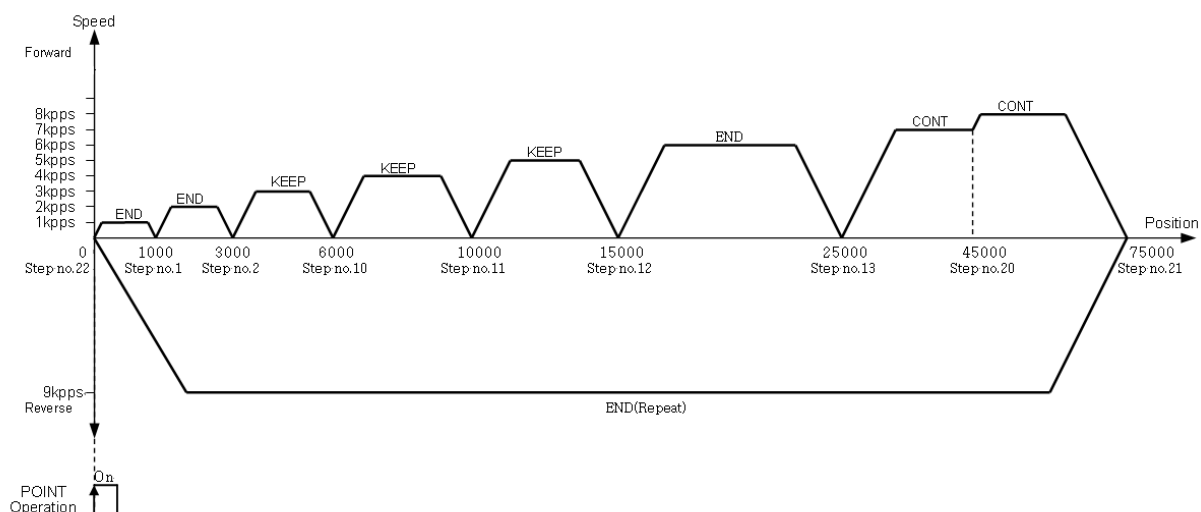

9.2.19 Positioning stop

Here describes factor which stops axis during operation.

(1) Stop command and Stop factor

Command and Stop factor which stop positioning operating are as follows. Those don't stop all axes and just stop the corresponding axis.

(a) When stop command is "On" or there are some stop factors at each axis, the corresponding axis will stop. But, in case of interpolation control (linear interpolation, Circular interpolation, helical interpolation, elliptic interpolation), when there is a stop command or stop factor on main axis, all axes of interpolation control stop.

Stop factor \ Status		Positioning ^{*1}	Home return ^{*2}	Jog Operation	Speed synchronous Cam control	Status of axis after stop	Status of "M code On" signal
Parameter setting ^{*3}	Exceed soft upper limit	Emg. stop	No Detection	Emg.stop		Error (Error501)	No change
	Exceed soft lower limit	Emg. stop	No Detection	Emg. stop		Error (Error502)	No change
Sequence program ^{*4}	Dec. stop command	Dec. stop	Dec. stop	Error 322 (Keeps operating)	Dec. stop ^{*5}	Stop status "On"	No change
	Emg. stop command	Emg. Stop				Error (Error481)	"Off"
External signal	External upper limit "On"	Emg. stop		Forward operation, Emg. stop	Emg. stop ^{*6}	Error (Error492)	No change
	External lower limit "On"	Emg. stop		Reverse operation, Emg. stop	Emg. stop	Error (Error493)	No change
	External emergency stop "On"	Emg. Stop				Error (Error491) Output inhibited	"Off"
	External stop "On" ^{*7}	Dec. stop	Dec. stop	Error322 (Keeps operating)	Dec. stop	Stop status "On"	No change
XG-PM Software	Deceleration stop command	Dec. stop	Dec. stop	Error322 (Keeps operating)	Dec. stop	Stop status "On"	No change
	Emergency stop command	Emg. stop				Stop status "On"	"Off"

Remark

- *1 : Positioning means position control, speed control, interpolation control, speed/position switching control, position/speed switching control, position/torque control by positioning data.
- *2 : After complete homing, DOG and HOME signal do not effect to positioning control. Emg and Dec stop time are controlled by Servo drive Setting.
- *3 : Software high/low limit check during speed control operation mode only works when "Software limit detect" is set as "1: detect".
- *4 : Sequence program means XGT program type.
- *5 : It decelerates according to Dec. stop time, auxiliary data of Dec. stop command, and speed becomes 0.
- *6 : It decelerates according to Dec. time for emg. Stop of basic parameter, and speed becomes 0.
- *7 : It is valid when the 「External command selection」 of extended parameter is "1: External stop command and 「External command」 is "1:Enable".

(2) Deceleration Stop

- (a) If meet emergency stop while operate indirect start, direct start, simultaneous start, start operation, homing operation, inching operation, it will sudden stop.
- (b) Deceleration stop command not different at these sections: acceleration section, constant section, deceleration section.
- (c) If it is decelerated and stopped by deceleration stop command, will not be completed positioning operation as set target position. And....
- No signal for completely positioning
 - M code signal cannot be "On" during "After" mode of "M code" mode.
- (d) If it receives order for indirect start command (step No. = current step No.) while it is stop,
- Positioning of absolute coordinate method: Operate amount of the position reminder which it isn't outputted on the current operation step.
 - Positioning of relative coordinate method: Operate as set movement at the target position.
- (e) There are two type of deceleration stop: Internal/external deceleration stop.
- Internal deceleration stop command
It decelerate and stop by XG-PM and 「deceleration stop」 command of sequence program as set support data.
 - External deceleration stop signal
In case of input signal of external emergency stop/deceleration stop to be "On", it will be decelerated and stopped by set deceleration time in current positioning operation.
Have to set item of "select external emergency stop/deceleration stop" of expansion parameter for using input signal of external emergency stop/deceleration stop as external deceleration stop command.

Item	Setting value	Contents
External command selection	0: external speed/position control switching	When there is external command input, it is used as "External speed/position control switching" signal
	1: external stop command	When there is external command input, it is used as "External stop command" signal
External command	0: Disable	External signal is ignored and doesn't affect the operation.
	1: Enable	Where there is external command input, it is operated as the signal specified "External command selection" item.

(f) Condition

- When command internal deceleration stop
The value of deceleration time can bigger than set value of deceleration time by auxiliary data.
- If deceleration stop command is inputted while operate Jog, error (error code: 322) will be made. Use "Stop Jog" command for Jog operation stop.
- If Dec. stop command is executed during stop, Dec. stop command will be ignored without error.

(g) Movement Timing

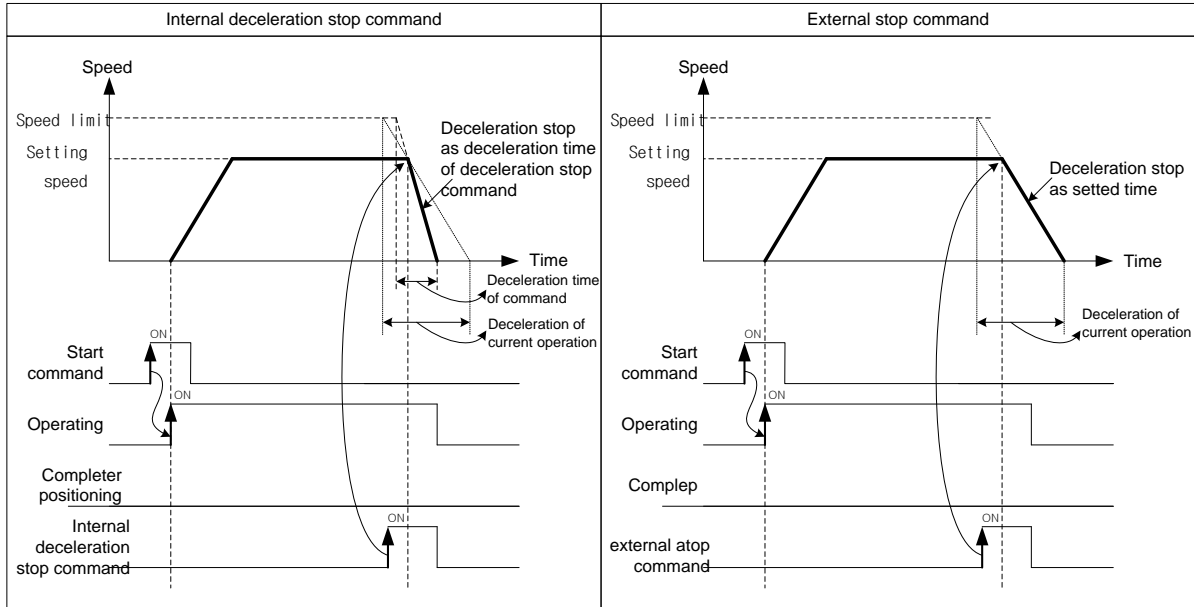

- If the deceleration distance is longer than distance to target position when input deceleration stop command during positioning control operation, it will be stopped at the target position.

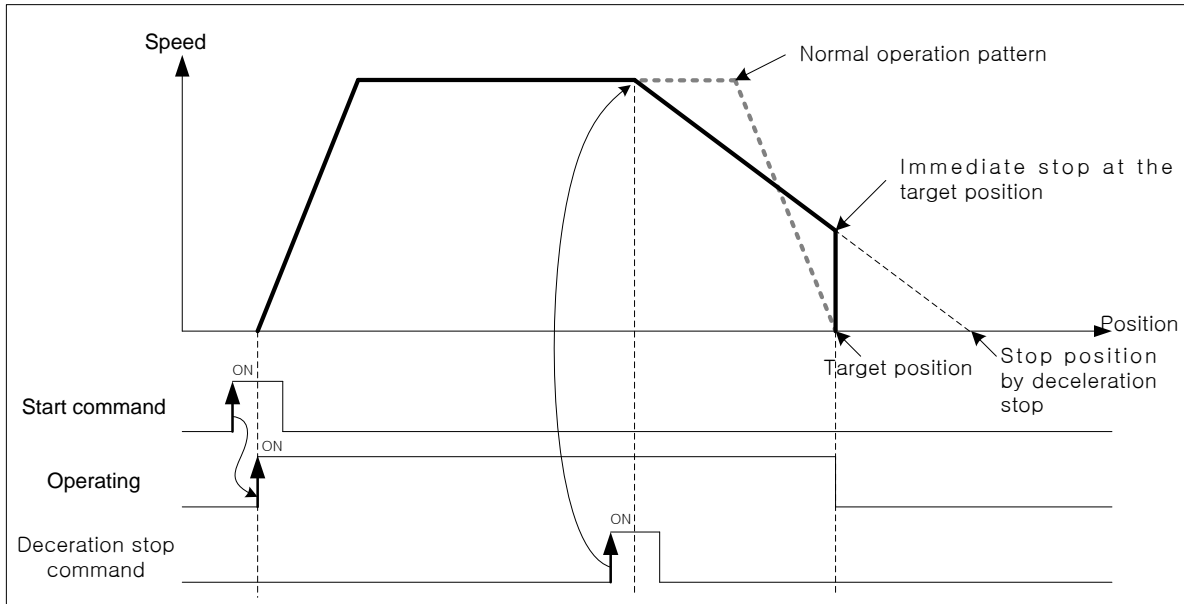

(3) Emergency Stop

- (a) It will be decelerated, stopped and occurred error as set time in 「deceleration time when it is suddenly stopped」 during indirect start, direct start, start at the same time, synch. operation, homing operation, jog operation, inching operation, when it be emergency stopped during operation.
- (b) In case of internal emergency stop, error 481 will occur and in case of external emergency stop, error 491 will occur.
- (c) M code signal will be “Off” after Emergency stop.
- (d) There are two type of Emergency stop: External emergency stop and Internal emergency stop.

- Internal emergency stop command

To be decelerated and stopped by 「emergency stop」 command of XG-PM & Sequence program as set time in 「deceleration time when it is suddenly stopped」, and error will be occurred.

- External emergency stop signal

In case of inputting signal of external emergency stop/ deceleration stop to be “On”, it will be decelerated, stopped and error will be occurred as set time in 「deceleration time when it is suddenly stopped」 of basic parameter.

Have to set “select external emergency stop/deceleration stop” of expansion parameter for using signal of inputting external emergency stop/deceleration stop as “external emergency stop command”

Item	Setting value	Contents
Select external emergency stop/ deceleration stop	0 : Emergency stop	Use as “emergency stop” signal when input external signal
	1 : Deceleration stop	Use as “deceleration stop” signal when input external signal

- Setting related parameter (Basic parameter)

Item	Setting value	Contents
When sudden stop, deceleration time	0 ~ 2147483647 [ms]	Set deceleration time for using when detect hardware high/low limit signal. Deceleration time express needed time for deceleration as bias speed at speed limit, when suddenly stop.

(e) Motion timing

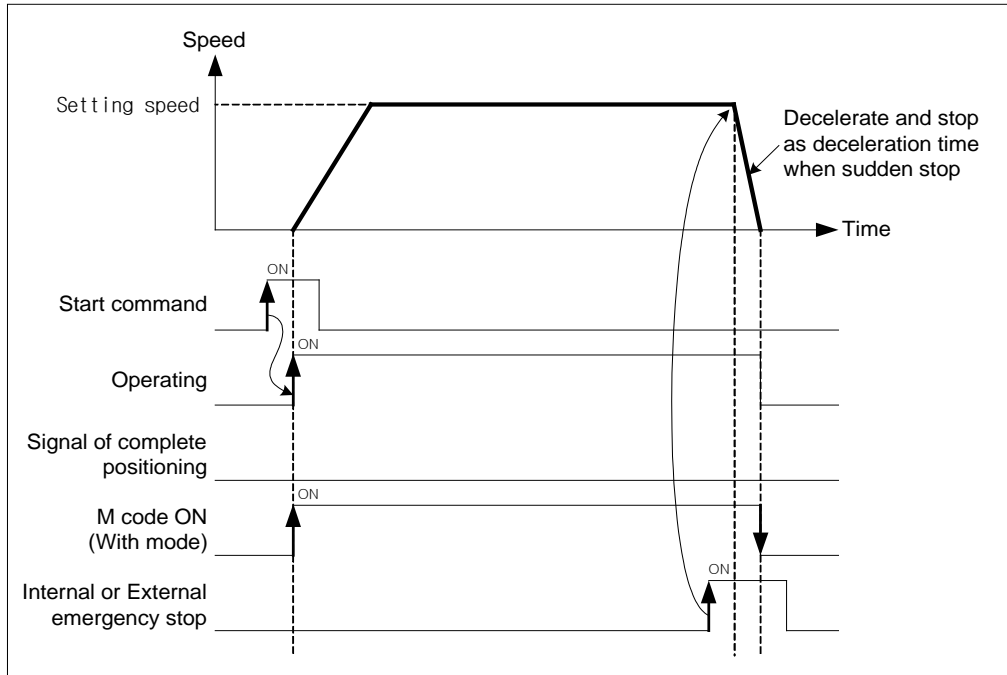

(4) Stop hardware by high/low limit

- (a) When positioning control, if the signal of hardware high/low limit is inputted, then stop positioning control and it will be decelerated and stopped as set time at 「deceleration time when it is suddenly stopped」, and error will be occurred.
- (b) In case of external input stroke high limit error, error 492 will occur and in case of external input stroke low limit error, error 493 will occur.

■ Setting related parameter (basic parameter)

Item	Setting value	Content
When sudden stop, deceleration time	0 ~ 2147483647 [ms]	Set deceleration time for using when detect hardware high/low limit signal. Deceleration time express needed time for deceleration as bias speed at speed limit, when suddenly stop.

(c) Motion timing

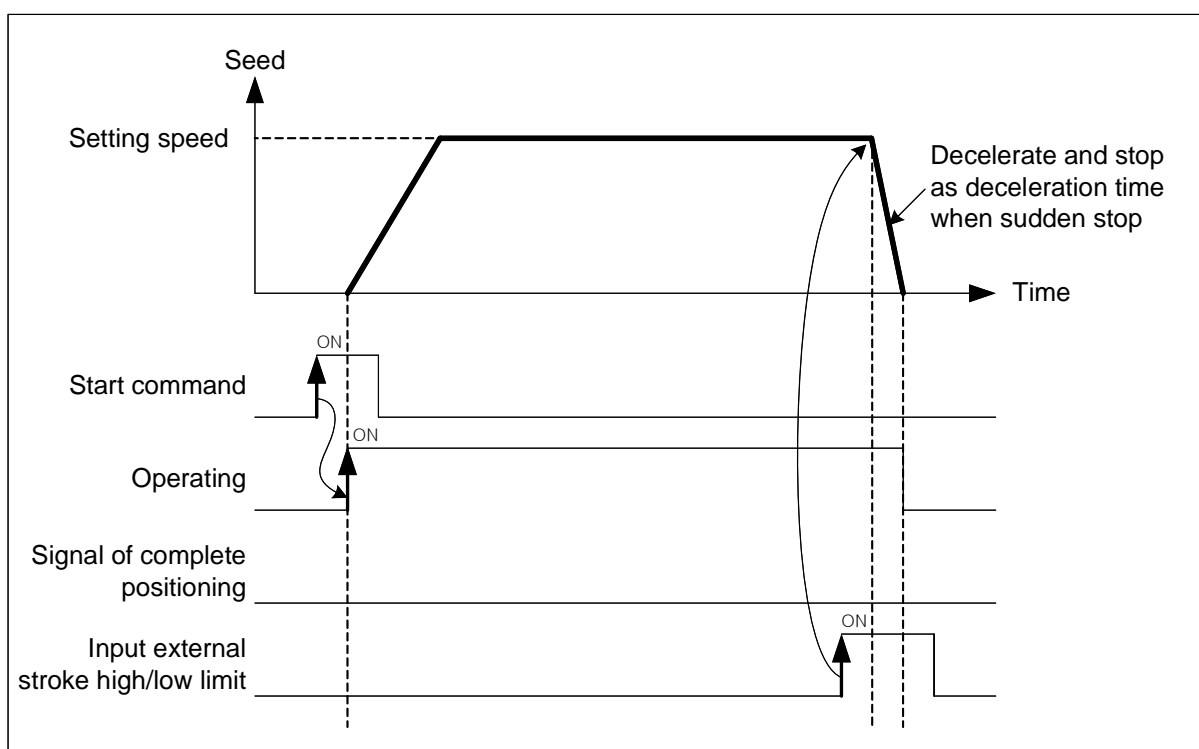

(5) Stop by software high/low limit

- (a) When positioning control, if value of current command position out of set value of expansion parameter in 「software high limit」 and 「software low limit」, it will promptly be stopped without outputting value of command position.
- (b) If value of command position to be out of software high limit range, will occur error 501, and if it to be out of software low limit range, will occur error 502.

■ Setting related parameter (expansion parameter)

Item	Setting value	Contents
Software high limit	-2147483648 ~ 2147483647	Set position of software high limit.
Software low limit	-2147483648 ~ 2147483647	Set position of software low limit.

(c) Condition

Software high/low limit not to be checked in the following case:

- In case of setting Software high/low limits as maximum (2147483647), minimum (-2147483648)
- In case of “Software high limit = Software low limit”

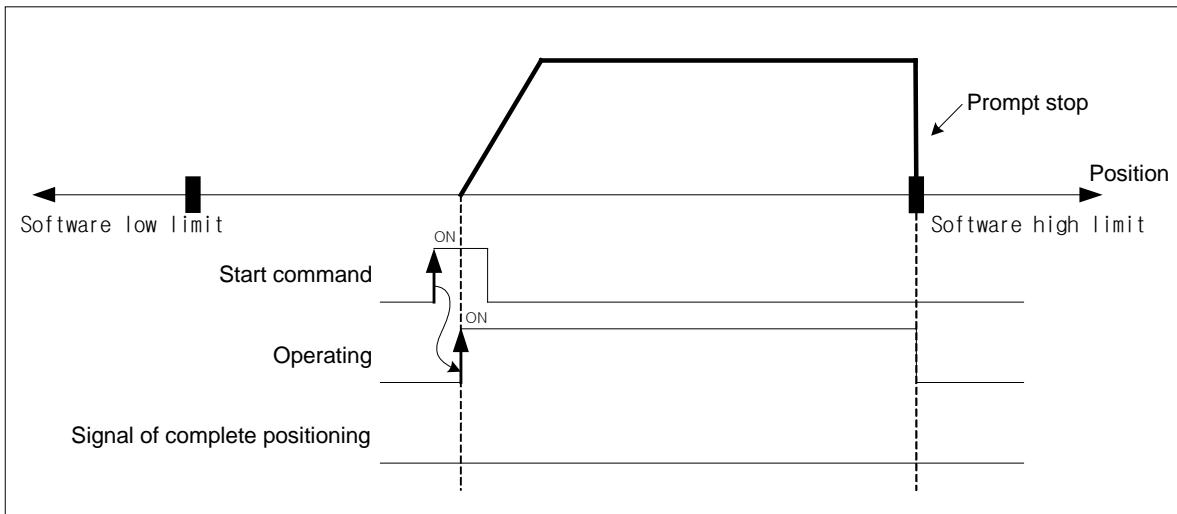

(d)
Motion
timing

(6) The priority of stop process

The priority of stop process of positioning module is as follows:

Deceleration stop < Sudden stop

When encounter factor of sudden stop in deceleration stop of positioning, it will be suddenly stopped. In case of sudden top deceleration time bigger than deceleration stop time, it will be decelerated and stopped as set deceleration stop time.

Remark

Process is as follows, when factor of sudden stop is occurred during deceleration stop.

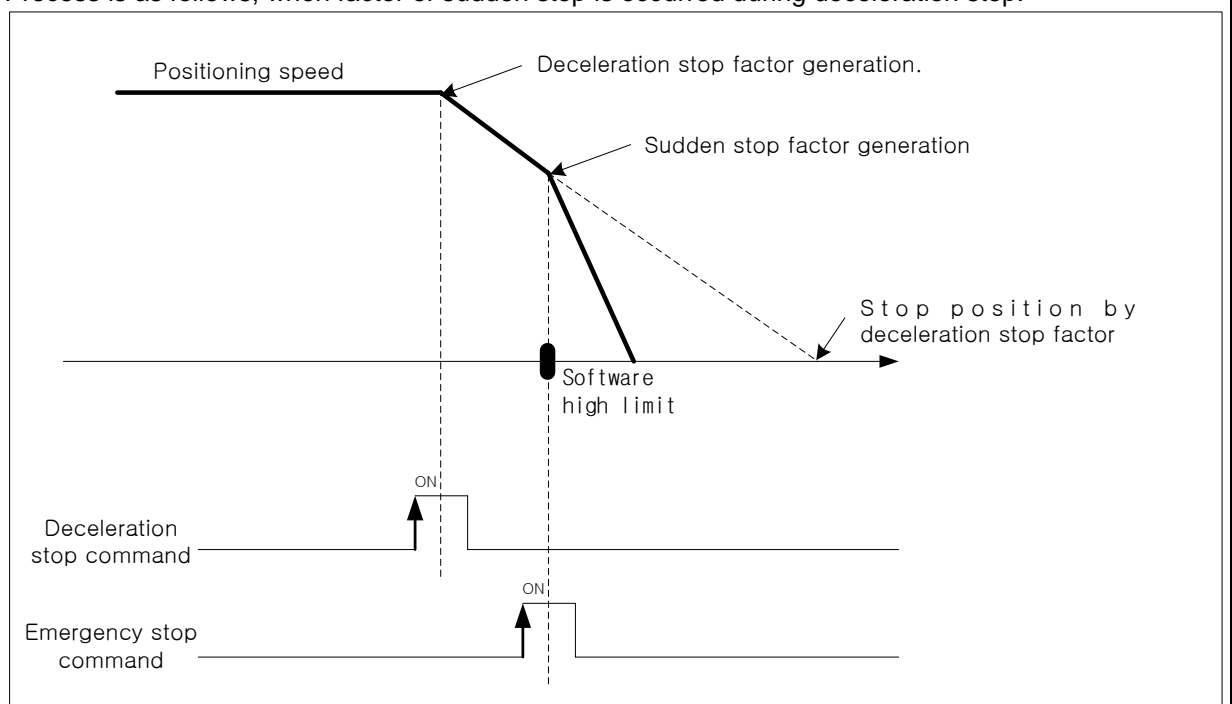

The factor of sudden stop : Emergency stop command or software high/low limit

(7) Stop command under interpolation operation

- (a) If encounters stop command during interpolation operation (linear interpolation, circular interpolation, helical interpolation, elliptic interpolation), it carries out the deceleration stop. It depends on the trace of wheels of origin.
- (b) When it restarts after deceleration stop, indirect start command carries out operation to target position of positioning. And then, operation depends on absolute coordinate and relative coordinate.
- (c) Stop command during interpolation operation can external/internal deceleration stop.
- (d) Deceleration stop command should be progressed at main axis which is operating for interpolation.
- (e) Operation pattern

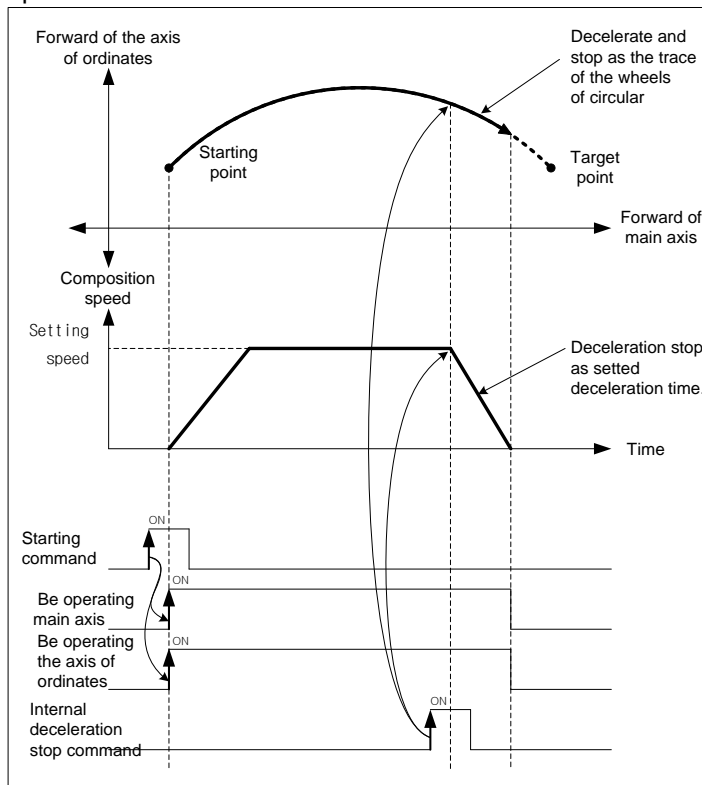

(8) Restart after Positioning stop

(a) Deceleration stop

When indirect start after deceleration stop, operate positioning as set operation step.

In case of using with mode, Signal "On" of M code has to "Off" for restart.

Signal On of M code have to be changed "Off" by 「Cancellation M code (XMOF)」 command.

(b) Restart after Internal/External emergency stop

In case of emergency stop, signal On of M code will automatically be "Off", therefore can operate positioning as set operation step, when it operate indirect start.

9.2.20 Restart

It describes the restart to operate the axis stopped by deceleration stop during positioning operation. If stopped decelerated by a factor of stop during positioning operation, it is possible to restart operation to the target position by using the "Restart" command and the previous operating conditions from the position stopped. However, the restart is valid when the previous command is "Direct start" and "Indirect start". The figure below, describes the operation of the restart.

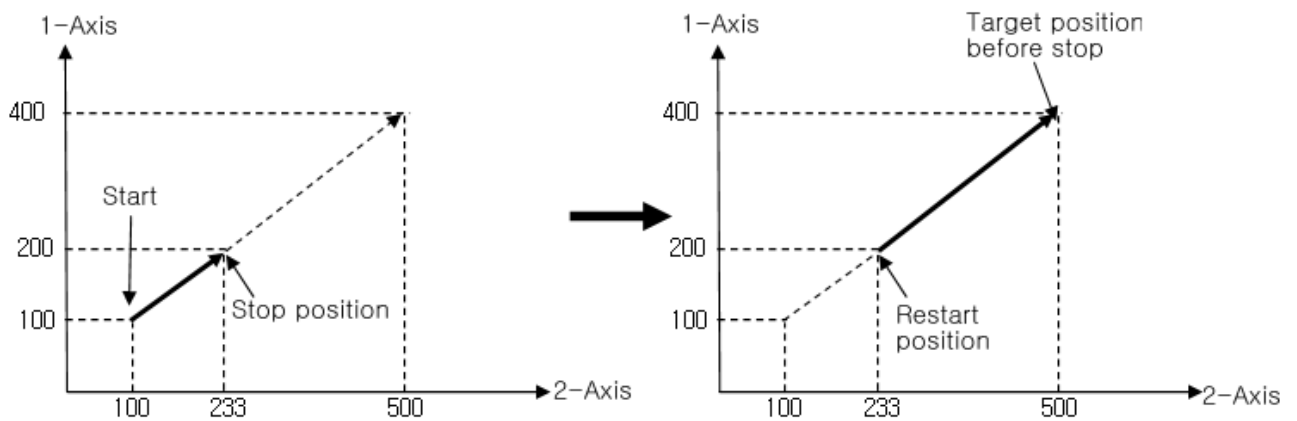

The figure below, describes the difference between restart and re-run the previous operation command in case of stopping after operation in incremental coordinate.

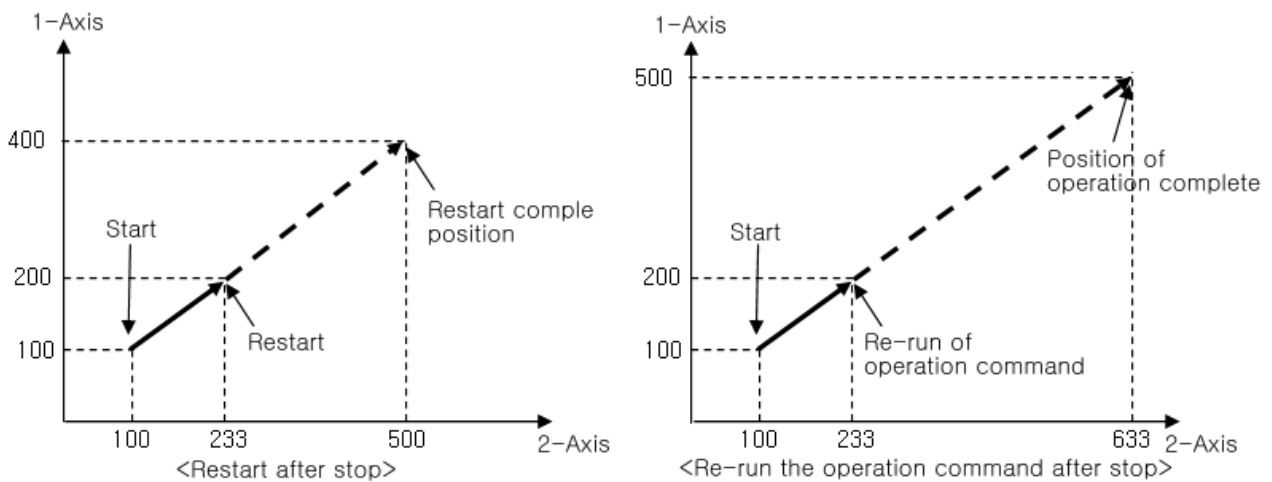

9.2.21 Torque control

It operates by set torque and executes by 「Torque control」 command until 「Deceleration stop」 command is inputted.

(1) Characteristic of control

- (a) Operate torque control by designated torque value(%) and gradient(ms).
- (b) auxiliary data of 「Torque control」 command.

Auxiliary data	Setting value	Contents
Torque (%)	-32768 ~ 32767	Set the torque value of target at the time of torque control. The Torque value is operated by % about rated torque.(1=rated torque of 1%)
Gradient (ms)	0 ~ 65535	Set gradient to the target torque by time.

※ Permissible range of torque value is different according to variety of servo drive connected. Commonly, target torque value is limited to maximum torque setting.

- (c) The direction is determined according to setting of torque value is the auxiliary data of the torque command.
 - When torque value is positive value (+) : Positioning in forward direction
 - When torque value is negative value (-) : Positioning in reverse direction

(2) Motion timing

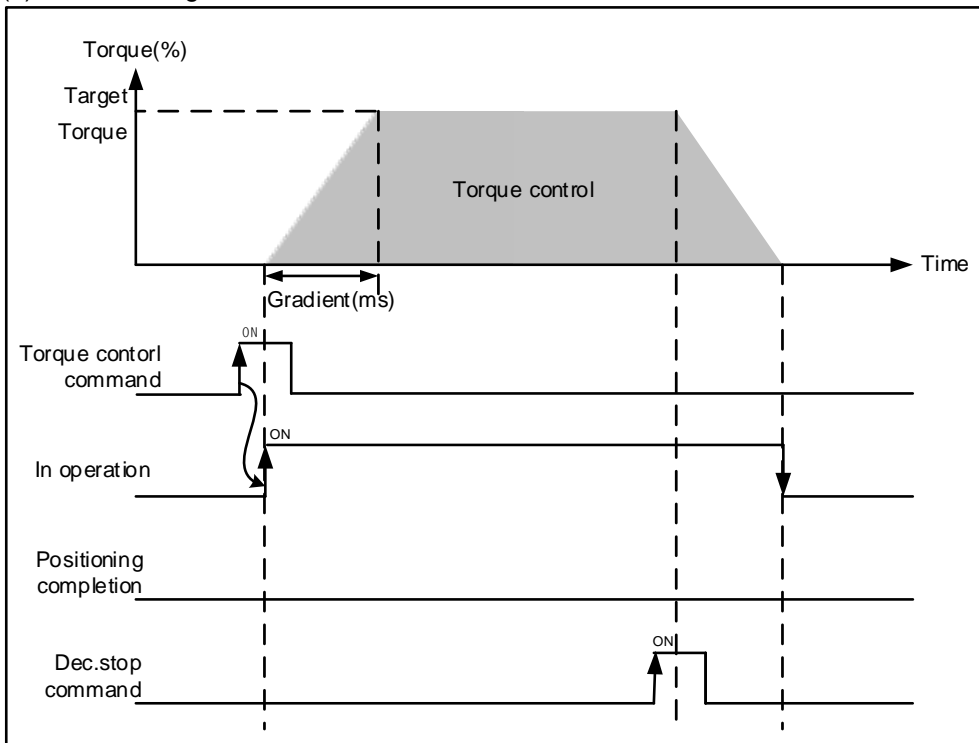

(3) Restrictions

(a) You can not execute torque control in the case as follows.

- If you execute the command in the state of during the operation except for torque control(Error code: 741)
- If you execute the command in the state in which the M code on signal is on(Error code: 742)
- If you execute the command in the state of servo-off(Error code: 743)
- If the servo drive does not support the torque control mode(Error code: 565)

9.2.22 Control by external input signal

The operation by external input signal use an existing encoder input terminal as an external input signal. When the external input signal is input, it is the function to perform set to input signal parameter.

(1) Characteristics of the control

(a) External input signal use 3 points as follows.

- External input signal A : [ENC A 24V(or A 5V) – A COM]
- External input signal B : [ENC B 24V(or B 5V) – B COM]
- External input signal Z : [ENC Z 24V(or Z 5V) – Z COM]

(b) In order to use the encoder input signal as an external input signal, you will need to set common parameters as follows.

	Item	Setting value
Common parameter	Function selection of external input terminal	1: External input signal A / B / Z
	Input filter of external input signal	0: Disable, 1: Enable

(c) The function executed when input signal A,B,Z is input can set in the input signal parameter.

	Item	Setting value
Input signal parameter	Function selection of input signal A	0: Unused 1: Switching speed/position control 2: Switching position/torque control 3: External operation
	Function selection of input signal B	
	Function selection of input signal Z	
	Logic selection of input signal A	A Contact, B Contact
	Logic selection of input signal B	
	Logic selection of input signal Z	
	Switching torque of external position/torque control	-32768 ~ 32767

(d) In 'Logic selection of input signal', you can choose the logic of the input signal A,B,Z is input to the module from the outside. In case it is selected to B contact, if no current flows through the input signal terminal, the module recognizes to On, if the current flows, the module is recognized Off

(2) Types of control

(a) Control switching of speed/position

Switch control to the position control from the speed controlled by the input signal. If you do not have speed control operation, when the external input signal is input, an error occurs.

Detailed function of control switching speed/position, please refer to the '9.2.14 switching control of speed / position'.

(b) Control switching of position/torque

Switch to the torque control from the position controlled by the input signal. Torque values are converted at the time of switching position / torque control, you can set in the item of "external location / torque control switching talk" parameter of the input signal.

Detailed function of control switching position/torque, please refer to the '9.2.17 switching control of position / torque'.

(c) External operation

Execute the operation data of current step number by input signal.

In case function selection parameter of the input signal is '3: External operation', it starts the operation the steps that have been saved in the current step number when the external input signal is input.

For users to drive the step operation data you want, please change the current step number using the first "Changing the starting step number" command.

Remark

1. In case function selection of external input terminal is '1: external input signal A,B,Z', Value of the encoder position is displayed as 0. It does not operate even if the encoder preset command, the value of the position of the encoder holds a value of 0.
2. If case function selection of external input terminal changes '0: Encoder signal A,B,Z', the encoder position value set initial value(0 if the maximum / minimum value contains a 0, minimum value if not included) after checking encoder maximum/minimum value
3. State of the external input signal of state information displays Off when external input terminal function selection is changed to '0: Encoder signal A,B,Z phase'.

(3) Status information

State of the external input signal A,B,Z, which can be confirmed by the state of the external I / O signal of state information area

Memory Address								Information 1 axis
1 axis	2 axis	1 axis	2 axis	1 axis	2 axis	1 axis	2 axis	
2C3	343	2C3	343	2C3	343	2C3	343	2C3

Bit 0	External EMG Stop	[0: External EMG stop Off, 1: External EMG stop On]
Bit 1	} Not used	[0]
Bit 2		
Bit 3		
Bit 4		
Bit 5	External lower limit signal	[0: External lower limit signal Off, 1: External lower limit signal On]
Bit 6	Home signal ^{*2}	[0: Home signal Off, 1: Home signal On]
Bit 7	DOG signal	[0: DOG signal Off, 1: DOG signal On]
Bit 8	External ^{*1} command signal	[0: External command signal Off, 1: External command signal On]
Bit 9	Servo On signal	[0: Servo Off, 1: Servo On]
Bit 10	Servo alarm signal	[0: Servo driver normal, 1: Servo driver error occurs]
Bit 11	In-position signal	[0: Not In-position section, 1: In-position section]
Bit 12	External input signal A	[0: External input signal A Off, 1: External input signal A ON]
Bit 13	External input signal B	[0: External input signal B Off, 1: External input signal B ON]
Bit 14	External input signal Z	[0: External input signal Z Off, 1: External input signal Z ON]
Bit 15	Communication error	[0: EtherCAT Comm. normal, 1: EtherCAT Comm. error]

9.3 Manual Operation Control

Manual control is a function that execute random positioning according to user's demand without operation data. Manual operations include Jog operation, Manual pulse generator operation, inching operation, previous position movement of manual operation etc.

9.3.1 Jog Operation

(1) Characteristic of Control

(a) Jog Operation is

- Execute positioning control at jog high/low speed depending on the signal of high/low speed during forward/reverse jog start signal is being ON.
- Positioning is started by Jog command from the state that the origin is determined. The value of positioning starts changing, user can monitor it.
- This is a way of manual operation that can be executed before determination of origin.

(b) Acceleration/Deceleration process and Jog speed

The acceleration/deceleration processing is controlled based on the setting time of Jog acceleration/deceleration time from XG-PM manual operation parameter setting.

Set the Jog speed on Jog high/low speed of XG-PM manual operation parameter setting.

If Jog speed is set out of the setting range, error will occur and the operation does not work.

■ Parameter setting (Manual Parameter)

Item	Setting value	Description
Jog High Speed	1 ~ Speed limit	Set Jog speed. Jog high speed must be set below limit
Jog Low Speed	1 ~ Jog High Speed	Set Jog speed. Jog low speed must be set below Jog high speed
Jog Acc. Time	0 ~ 2147483647	Set the acc. Time used in acceleration of Jog operation
Jog Dec. Time	0 ~ 2147483647	Set the dec. time used in deceleration of Jog operation

Remark

If "Jog Acc. Time" is 0, it operates at "Acc. Time1" of basic parameter.

If "Jog Dec. Time" is 0, it operates at "Dec. Time1" of basic parameter.

(2) Operation Timing

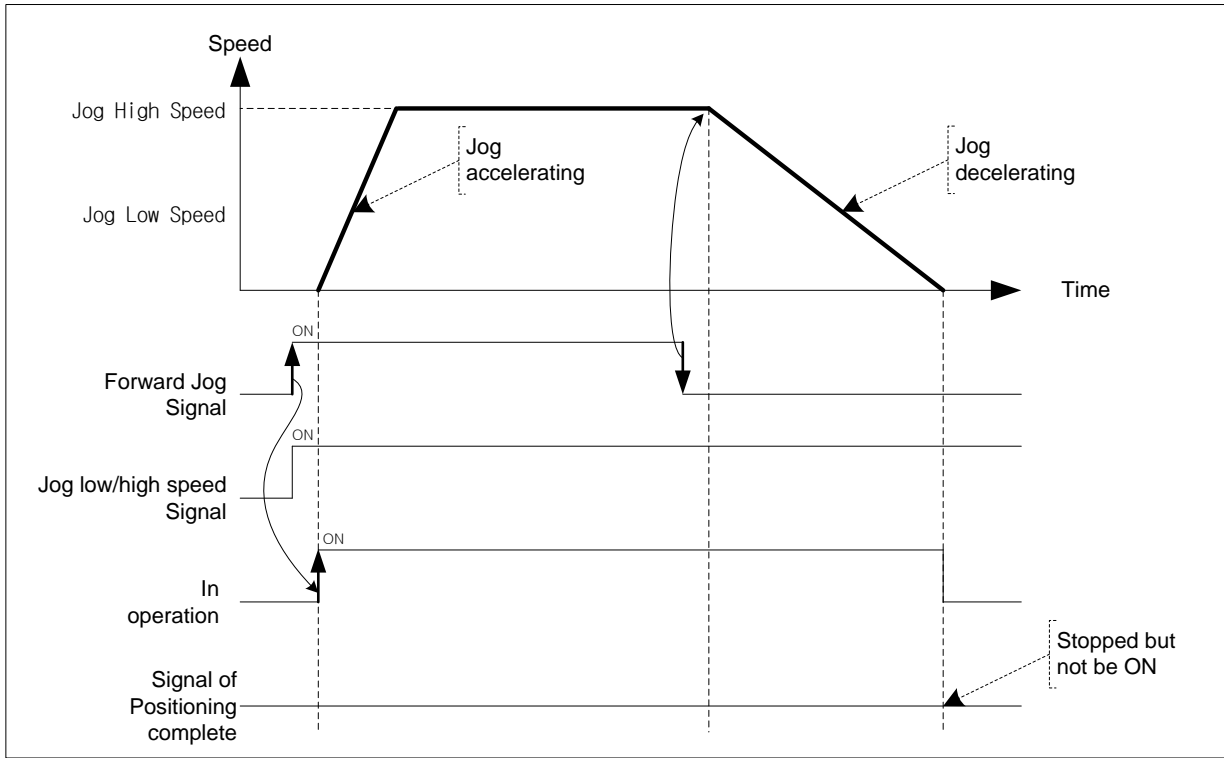

Remark

Notices for setting Jog speed are as follows.

$$\text{Jog Low Speed} \leq \text{Jog High Speed} \leq \text{Speed Limit}$$

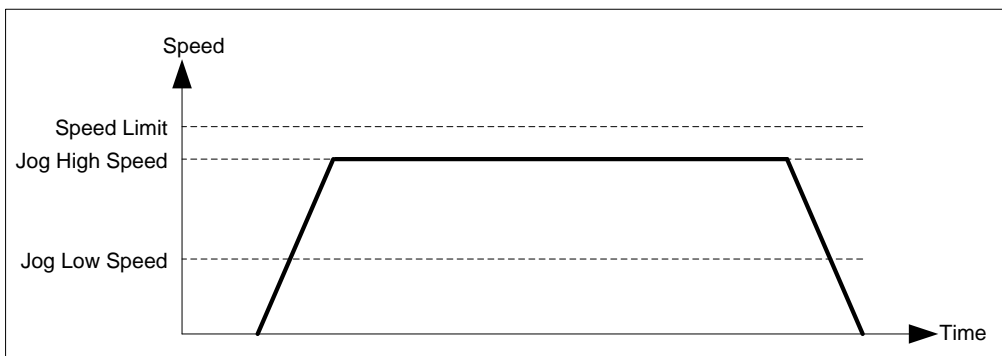

(3) Restrictions

You can not execute Jog operation in the case as follows.

- (a) Value of Jog High Speed exceeds the speed limit of basic parameter (Error code : 121)
- (b) Value of Jog Low Speed exceeds the value of Jog high speed. (Error code : 122)

(4) Jog Operation Start

Jog operation start consists of Start by XG-PM and Start by Sequence program. The start by sequence program is that execute Jog operation with output contact of CPU.

Axis	Direction of Signal : CPU -> Positioning module	
	Output Signal	Description
Axis1	UXX.01.0	Axis1 Forward Jog
	UXX.01.1	Axis1 Reverse Jog
	UXX.01.2	Axis1 Jog Low/High Speed
	UXX.01.3	-
Axis2	UXX.01.4	Axis2 Forward Jog
	UXX.01.5	Axis2 Reverse Jog
	UXX.01.6	Axis2 Jog Low/High Speed
	UXX.01.7	-
Axis3	UXX.01.8	Axis3 Forward Jog
	UXX.01.9	Axis3 Reverse Jog
	UXX.01.A	Axis3 Jog Low/High Speed
	UXX.01.B	-
Axis4	UXX.01.C	Axis4 Forward Jog
	UXX.01.D	Axis4 Reverse Jog
	UXX.01.E	Axis4 Jog Low/High Speed
	UXX.01.F	-
Axis5	UXX.02.0	Axis5 Forward Jog
	UXX.02.1	Axis5 Reverse Jog
	UXX.02.2	Axis5 Jog Low/High Speed
	UXX.02.3	-
Axis6	UXX.02.4	Axis6 Forward Jog
	UXX.02.5	Axis6 Reverse Jog
	UXX.02.6	Axis6 Jog Low/High Speed
	UXX.02.7	-
Axis7	UXX.02.8	Axis7 Forward Jog
	UXX.02.9	Axis7 Reverse Jog
	UXX.02.A	Axis7 Jog Low/High Speed
	UXX.02.B	-
Axis8	UXX.02.C	Axis8 Forward Jog
	UXX.02.D	Axis8 Reverse Jog
	UXX.02.E	Axis8 Jog Low/High Speed
	UXX.02.F	-

[Example] Execute Jog start in the order as follows.

- Forward Jog Low speed Operation -> Forward Jog High speed Operation -> Stop
- Reverse Jog High speed Operation -> Reverse Jog Low speed Operation -> Stop

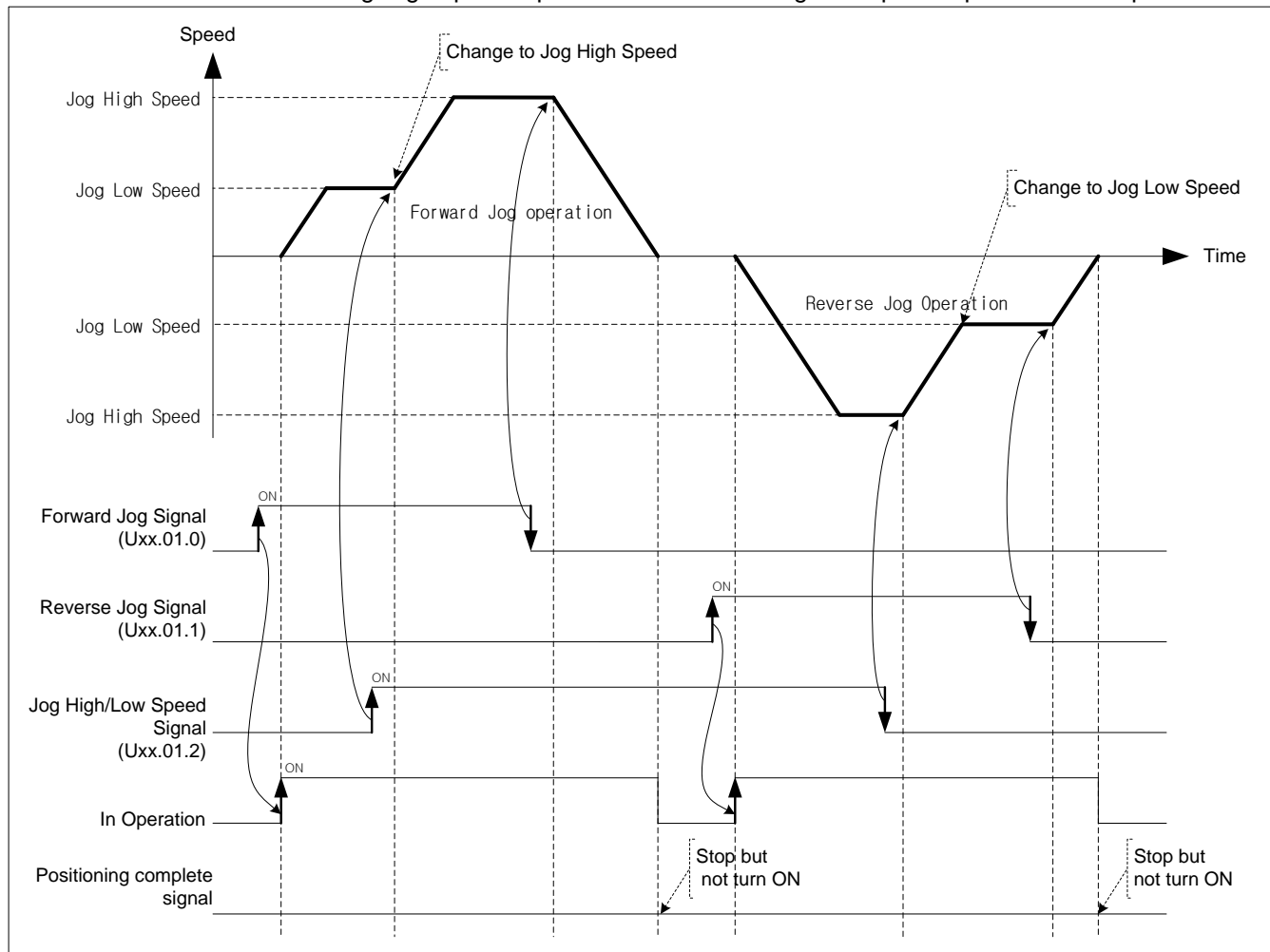

Remark

Dec. stop command will not be executed in Jog Operation.
 Jog operation will stop if turn the Jog signal of the current operating direction Off.

9.3.2 Inching Operation

This is a kind of manual operation and executing positioning at the speed already set on manual operation parameter as much as the amount of movement already set on the data of inching operation command.

(1) Characteristics of Control

- (a) While the operation by ON/OFF of Jog signal is difficult in moving to the correct position as the operation starts and stops according to the command, the inching command enables to set the desired transfer amount easily and reach the goal point.
- (b) Thus, it is available to reach the correct goal position by moving fast near the working position by Jog command and operating the detail movement by inching command.
- (c) The setting range is $-2147483648 \sim 2147483647$ Pulse.
- (d) The direction of moving depends on the amount of inching.
 - The amount is POSITIVE(+): Positioning operation in forward direction
 - The amount is NEGATIVE(-): Positioning operation in reverse direction
- (e) Acc./Dec process and Inching speed

Use Jog acc./dec. Time of manual operation as acc./dec. time of Inching operation.

Set Jog acc./dec. time on "Jog acc./dec. time" of manual operation parameter setting of XG-PM.

Set Inching speed on "Inching speed" of manual operation parameter setting.

If inching speed is set out of the setting range, error will occur and the operation does not work.

■ Related parameter setting (Manual operation parameter)

Items	Setting value	Description
Jog acc. Time	0 ~ 2147483647	Set the accelerating time for acceleration of Inching operation
Jog dec. Time	0 ~ 2147483647	Set the decelerating time for deceleration of Inching operation
Inching Speed	1 ~ Speed limit	Set the speed of Inching operation

(2) Operation Timing

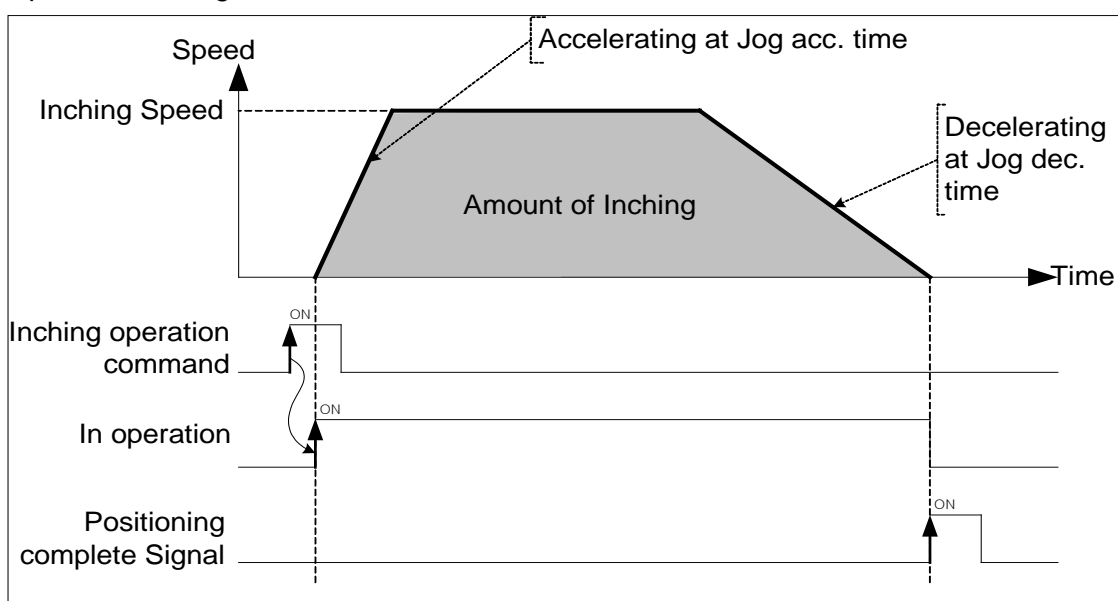

9.3.3 Return to the position before manual operation

This positioning control function is used to return to the position address that the positioning is completed before manual operation when the position is changed by manual operation (Jog operation, inching operation).

(1) Characteristic of Control

(a) Direction of moving depends on the current position and the previous position of manual operation.

- Starting position < The previous position of manual operation : Forward direction
- Starting position > The previous position of manual operation : Reverse direction

(b) Acc./Dec. process and the speed of return

Acc./Dec. time of returning is the same as homing acc./dec. time of homing parameter.

Set acc./dec. time on homing acc./dec. time of homing parameter of XG-PM.

If returning speed is set out of the setting range, error will occur and the operation does not work.

■ Related parameter setting (Manual Operation Parameter)

Item	Setting value	Description
Homing speed	1 ~ Speed limit	Set returning speed
Homing acc. time	0 ~ 2147483647	Set acc. time used in return
Homing dec. time	0 ~ 2147483647	Set dec. time used in return

(2) Operation timing

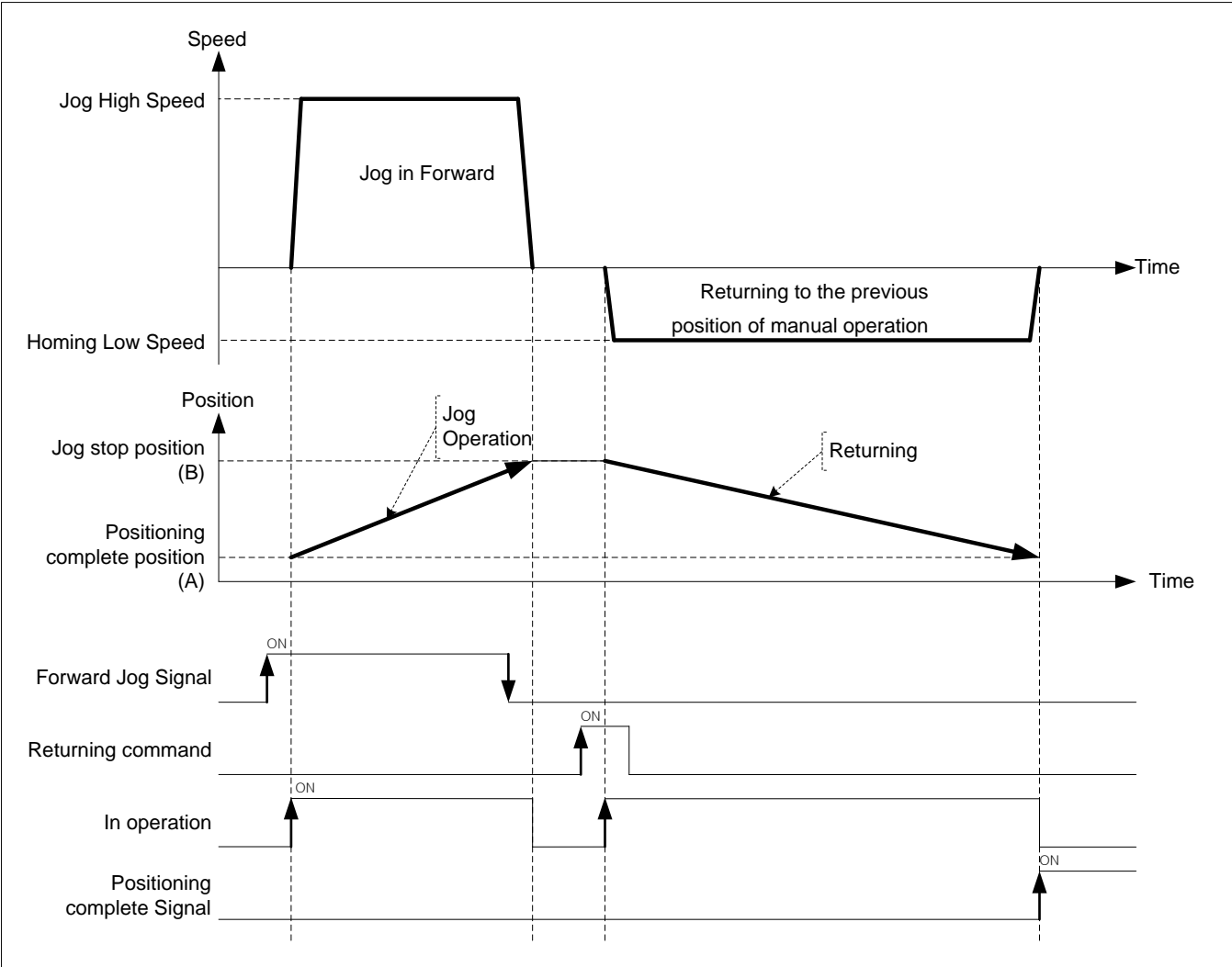

If value of the current position is "A" after positioning control operation and the positioning value changed by Jog operation is "B", execute positioning to "A" when executing the returning to the previous position of manual operation.

9.4 Synchronous Control

This is the command that control the operation synchronizing with the main axis or operating of encoder.

9.4.1 Speed Synchronous Control

This is the command that synchronize with sub axis in speed and control operation depending on speed synchronous rate already set when main axis starts.

(1) Characteristic of Control

- (a) Start and Stop is repeated depending on operating of main axis after execution of speed synchronous command. The operating direction of sub axis and the main's are same.
- (b) The operating direction of sub axis depends on the ratio of speed sync. $(\frac{SubAxis}{MainAxis})$. If it is positive, the direction is forward. If it is negative, the direction is reverse.
- (c) If execute speed sync. command, it will be the state of operating and remain in the state of speed sync. operation before release of speed sync. command.
- (d) Auxiliary data of speed sync. command

The auxiliary data used in speed sync. command is as follows.

Item	Setting value	Description
Main Axis	1(axis1) ~ 8(axis8), 9(Encoder1)	Set the main axis of speed sync.
Ratio of Main axis	-32768 ~ 32767	Set the ratio of main axis at speed sync. ratio.
Ratio of Sub axis	-32768 ~ 32767	Set the ratio of sub axis at speed sync. ratio..

Ratio of Speed sync. is calculated as follows.

$$Ratio = \frac{SubAxis}{MainAxis}$$

It is possible to set like “Ratio of Main axis(Absolute) < Ratio of Sub axis(Absolute)” at setting ratio of speed sync.

Operating speed of sub axis is calculated as follows.

$$\begin{aligned}
 \text{Operaing speed of SubAxis} &= \text{Operating Speed of MainAxis} \times \text{Ratio of speed sync.} \\
 &= \text{Operating Speed of MianAxis} \times \frac{\text{Ratio of SubAxis}}{\text{Ratio of MainAxis}}
 \end{aligned}$$

- (e) Modifying the ratio of speed sync. in operation is available.

When modify the ratio, if there is too big gap between the former ratio and the current ratio, the machine is possible to be damaged.

(2) Operation Timing

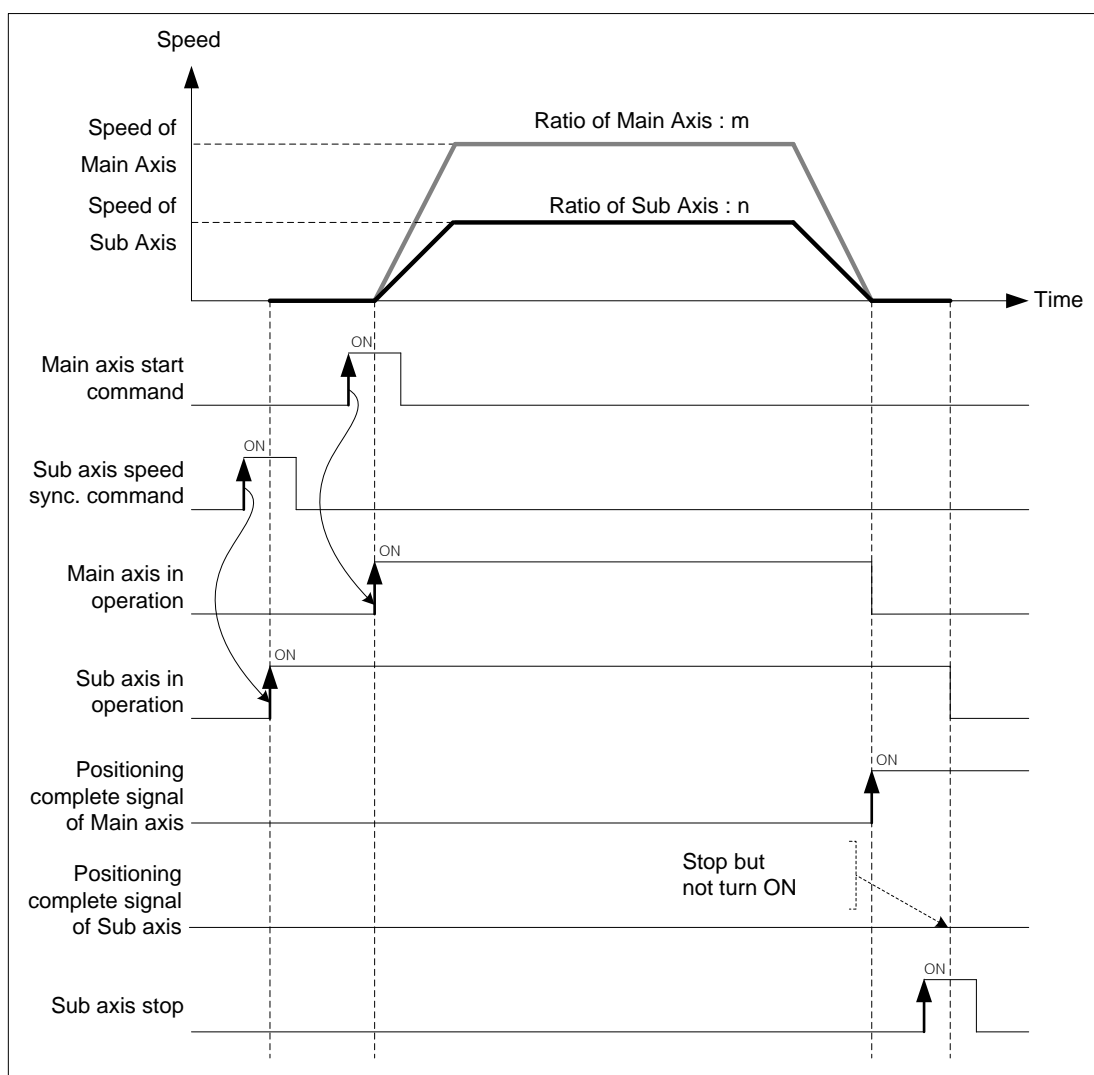

(3) Restrictions

You can not execute Jog operation in the case as follows.

- If speed sync. is executed in being On of M code signal, error (code:353) arises. Make M code "off" with M code release command (XMOF) before use.
- In the case that the axis set as main axis is not the axis can be set or the case that the setting of main axis is the same as the setting of command axis, error (code"355) arises. Set the main axis among the axis available to be set.
- If the speed of main axis exceeds the speed limit, error (code:357) arises. In the case, the speed of main axis has to be down below the speed limit.

In the case that the speed of main axis exceeds the speed limit, error arises and it decelerate in "Dec. time of "emergent stop".

[Example] axis1 is main axis, axis2 is sub axis. Operate at “ratio of main axis : ratio of sub axis = 2 : 1” at the beginning and then execute speed sync. control changing the ratio to “ratio of main axis : ratio of sub axis = 1 : 2”

- Example of setting in XG-PM
- Operation data of main axis(axis1)

Step no.	Control method	Operation method	Goal Position [pls]	Operating speed [pls/s]	Acc. no.	Dec. no.	M code	Dwell Time
1	Incremental, Reduction position control	Single, End	10000	2000	No. 1	No. 1	0	0

- Operating pattern

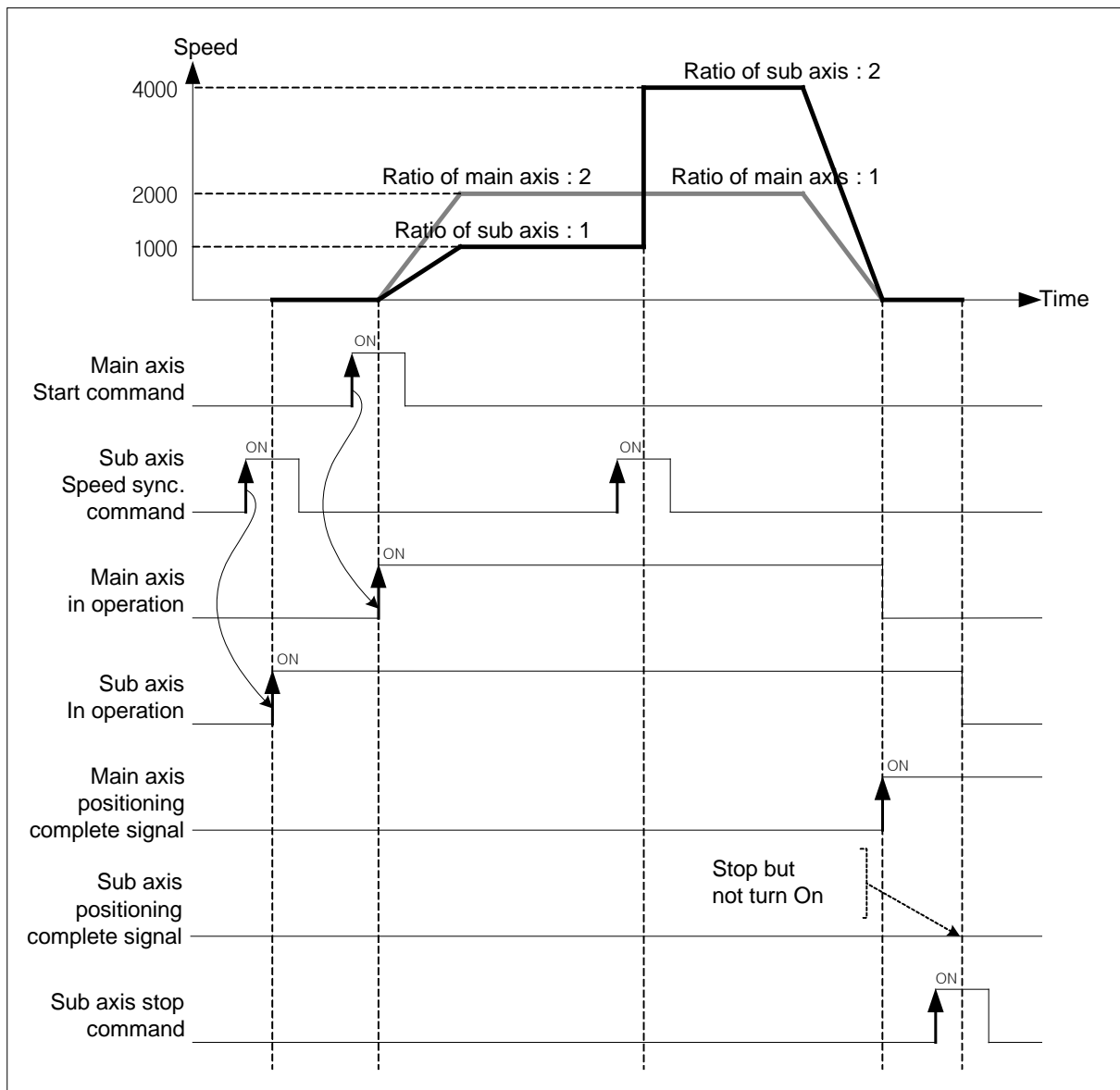

(4) Speed synchronous control with encoder

- (a) Set encoder as the main axis of speed sync. and execute positioning control by ratio of speed sync. that consists of pulse speed from encoder, ratio of main axis and ratio of sub axis.
- (b) This command is used in the case that executing thorough positioning manually.
- (c) After executed speed sync. command, when the pulse string is inputted, speed sync. control starts.
- (d) Operate regardless of the state of origin.
- (e) The pulse inputted by encoder increase of decrease the position value of encoder.
- (f) The direction of moving depends on encoder pulse input mode and ratio of speed sync,
 - Positioning in forward direction : Input pulse of A phase is ahead of B's
 - Positioning in reverse direction : Input pulse of B phase is ahead of A's

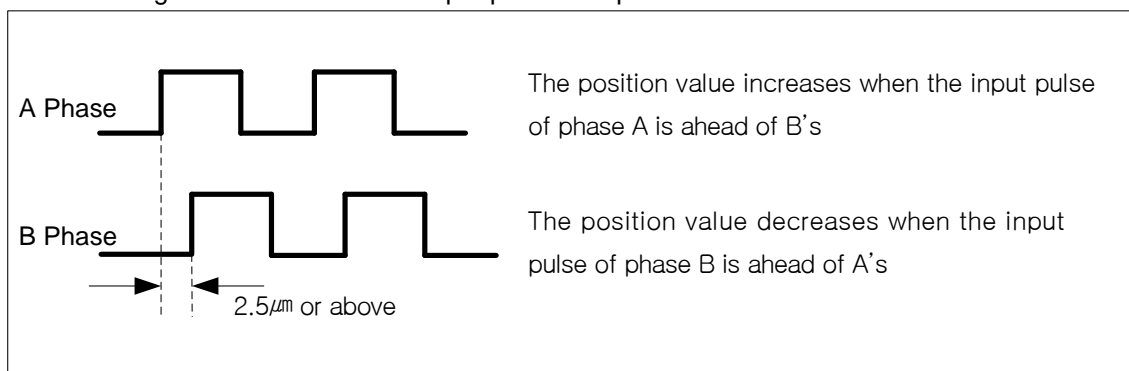

- The operating direction of sub axis depends on $Ratio\ of\ speed\ sync. (\frac{Ratio\ of\ SubAxis}{Ratio\ of\ MainAxis})$. If it is positive, operating direction will be forward direction of encoder. If it is negative, operating direction will be reverse direction of encoder.

(g) Related parameter (Common Parameter)

Set parameter related to encoder on common parameter.

Item	Setting Value	Description
Encoder1 Pulse Input	0 : CW/CCW 1 multiplying 1 : PULSE/DIR 1 multiplying 2 : PULSE/DIR 2 multiplying 3 : PHASE A/B 1 multiplying 4 : PHASE A/B 2 multiplying 5 : PHASE A/B 4 multiplying	Set the encoder type to be used as input of encoder1
Encoder1 Z phase clear	0: Disable 1: Enable	Set whether to use Z phase input of Encoder1 as counter clear signal or not
Encoder1 max. value	-2147483647 ~ 2147483647	With encoder1 max. and min. value, it sets the count range
Encoder1 min. value	-2147483647 ~ Encoder1 max. value	

[Example] Execute speed sync. control with encoder (main axis), axis2(sub axis) at “the ratio of main axis : the ratio of sub axis = 1 : 2”.

(Hypothesize that the input speed of encoder is 1Kpps)

When the direction of encoder is forward, the operating direction of sub axis is reverse. When the direction of encoder is reverse, the operating direction of sub axis is forward.

■ Operating pattern

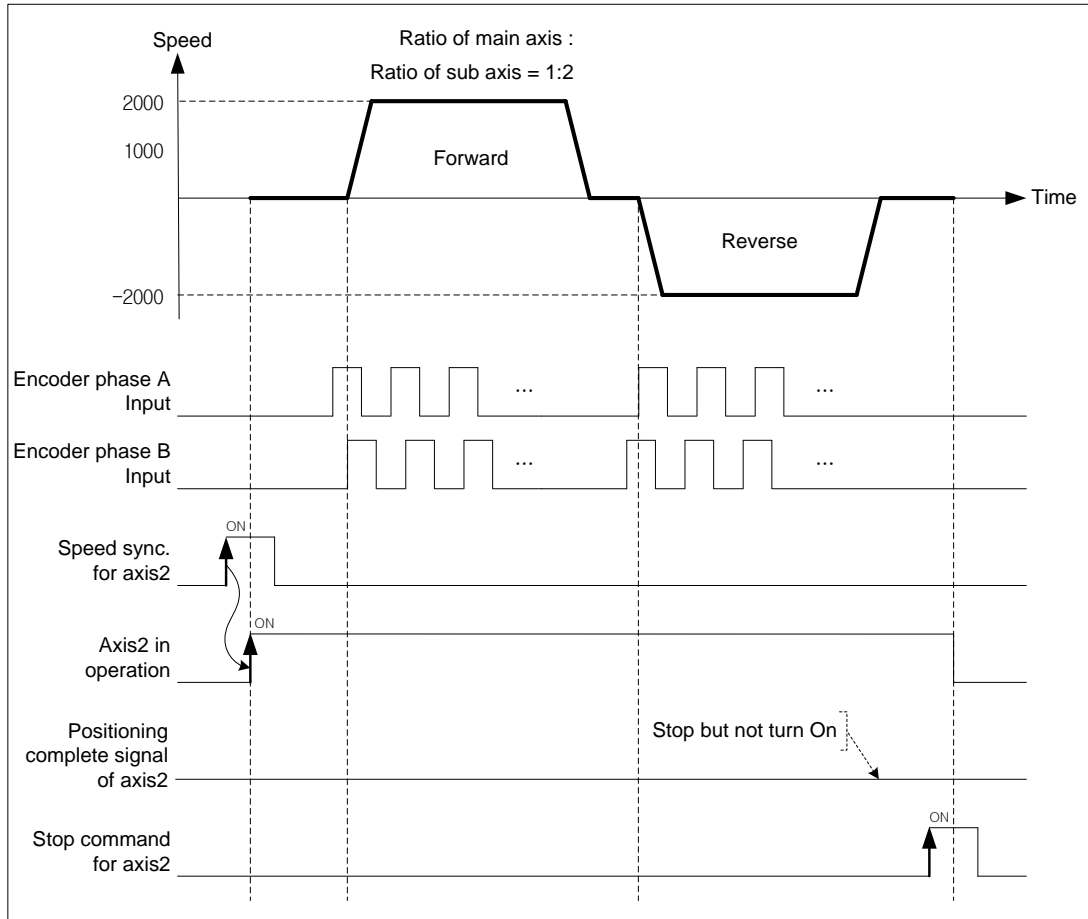

(5) Position-specified speed sync. control

(a) The basic operation of positioning speed sync. control is similar to speed synchronization. After executing positioning speed sync. command, start and stop are repeated depending on operation of main axis. The direction of sub axis and the direction of main axis are same.

(b) The operating direction of sub axis depends on *Ratio of speed sync.* ($\frac{\text{Ratio of SubAxis}}{\text{Ratio of MainAxis}}$). If it is

positive, operating direction will be forward direction of main axis. If it is negative, operating direction will be reverse direction of main axis.

(c) If give speed sync. command to sub axis, it will be changed to the operating state and stay at operating state until release command.

(d) If the current position of sub axis become the goal position, it stops speed sync. and stay there. For the details, refer to "Speed sync. control".

(e) Auxiliary data of positioning speed sync. command.

The auxiliary data used in speed sync. is as follows.

Items	Setting value	Description
Main axis	1(axis1) ~ 4(axis4), 9(Encoder)	Set main axis
Ratio of main axis	-32768 ~ 32767	Set ratio of main axis
Ratio of sub axis	-32768 ~ 32767	Set ratio of sub axis
Goal position	-2147483648 ~ 2147483647	Set the goal position of positioning speed sync.

(f) Operation timing

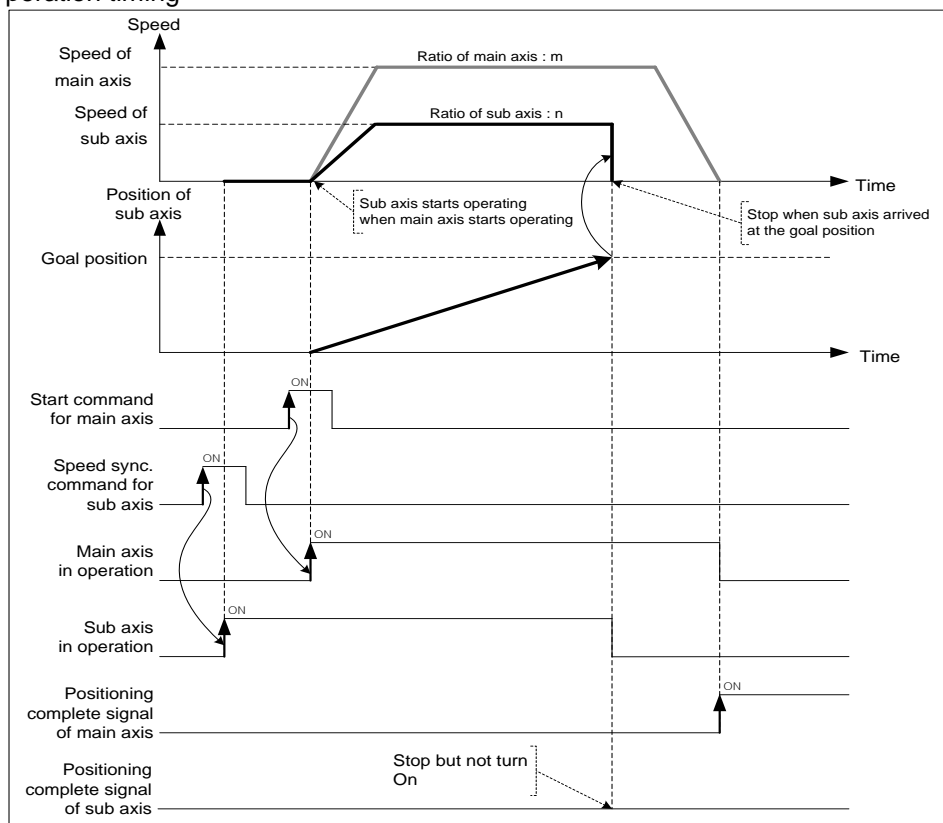

9.4.2 Position synchronous control

Start positioning with step no. and operation data when the current position of main axis is same as the position set in position sync.

(1) Characteristics of control

- (a) Synchronous Start by Position (SSP) command is carried out only in case that the main axis is in the origin determination state.
- (b) SSP command starts by the synchronization of the subordinate axis according to the current position of the main axis.
- (c) SSP carries out the SSP command at the subordinate axis.
- (d) If SSP command is executed, it becomes the state in operation and the actual operation is carried out at the subordinate axis where the current position of the main axis is the setting position of the position synchronous start.
- (e) In case of cancellation after executing the SSP command at the subordinate axis, if you execute the stop command, the SSP command shall be released.
- (f) The auxiliary data of position sync. command

The auxiliary data used in position sync. is as follows.

Items	Setting Value	Description
Position of position sync.	-2147483648 ~ 2147483647	Set the position of main axis in position sync. control
Operation step	1 ~ 400	Set the step no. to be executed when the main axis arrives at the position for position sync.
Main axis	1(axis1) ~ 8(axis8), 9(Encoder1)	Set the main axis of position sync.

Remark

Even though the current position of main axis and the setting value set on position sync. are not exactly same, if the current position of main axis is at between the position of main axis of previous scan and the current position of main axis, the sub axis will be executed with the positioning data of step no. set on operation step.

(2) Operation timing

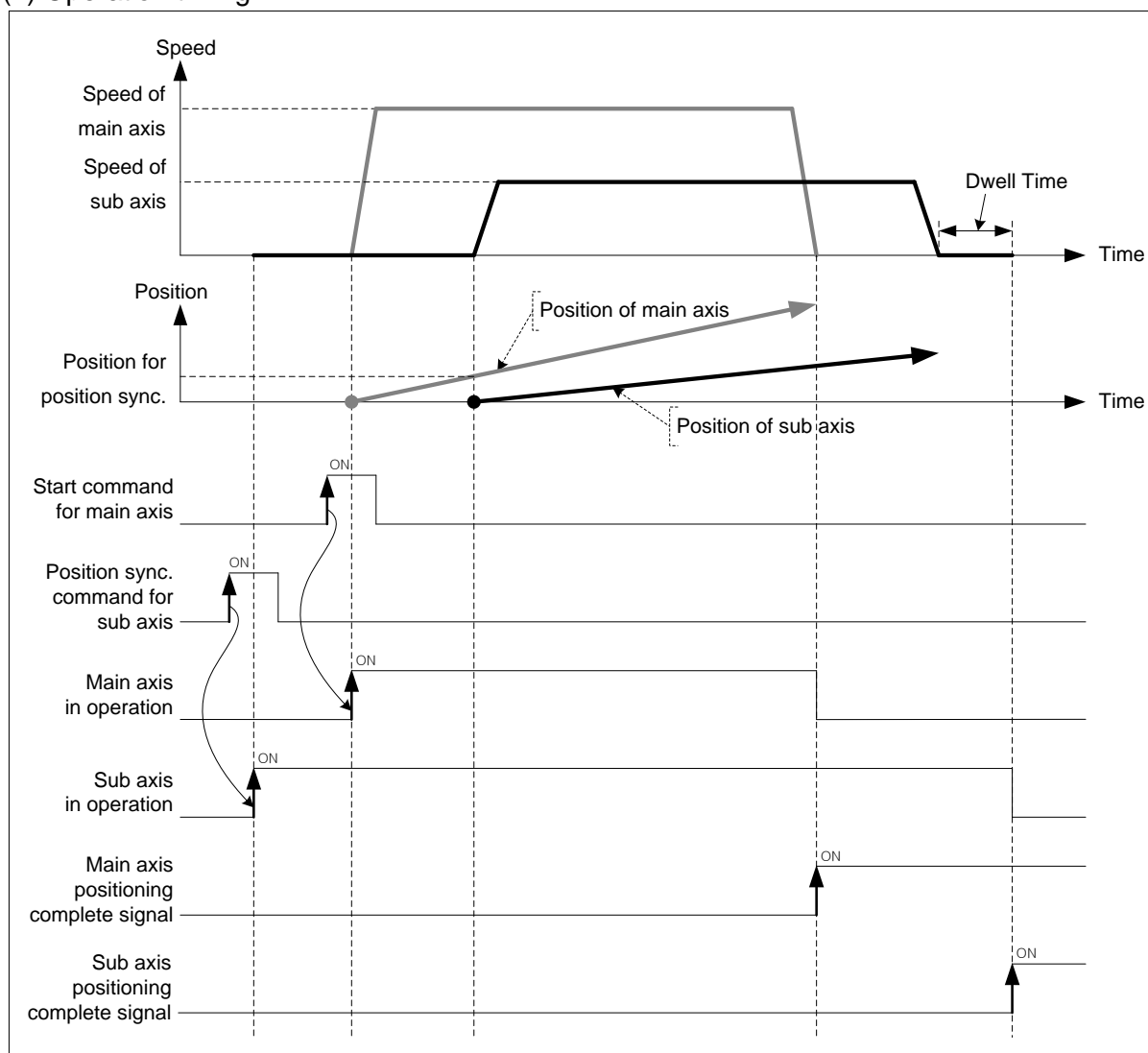

(3) Restrictions

Position sync. control can be executed in the case below.

- If position sync. command is executed in M code signal is On, error (code:343) arises. Use it after making M code "Off" with M code release command(XMOF).
- If the current main axis is not the axis can be set on the current module or main axis and command axis are the same axis, error (code:355) arises. Set the main axis among one of the axis can be set on module.

[Example] Axis1 is main axis, axis2 is sub axis. The position of main axis for position sync. is 1000, execute position sync. with operation data no.10.

- The current position of axis1 : 0
The current position of axis2 : 0
- Example in XG-PM
 - Main axis (axis1) Operation data

Step no.	Control method	Operation	Goal position [pls]	Operating speed [pls/s]	Acc. no.	Dec. no.	M code	Dwell time
1	Incremental, single-axis position control	Single, End	2000	1000	No. 1	No. 1	0	0

- Sub axis (axis2) Operation data

Step no.	Control method	Operation	Goal position [pls]	Operating speed [pls/s]	Acc. no.	Dec. no.	M code	Dwell time
10	Incremental, single-axis position control	Single, End	2000	2000	No. 2	No. 2	0	0

- Operating pattern

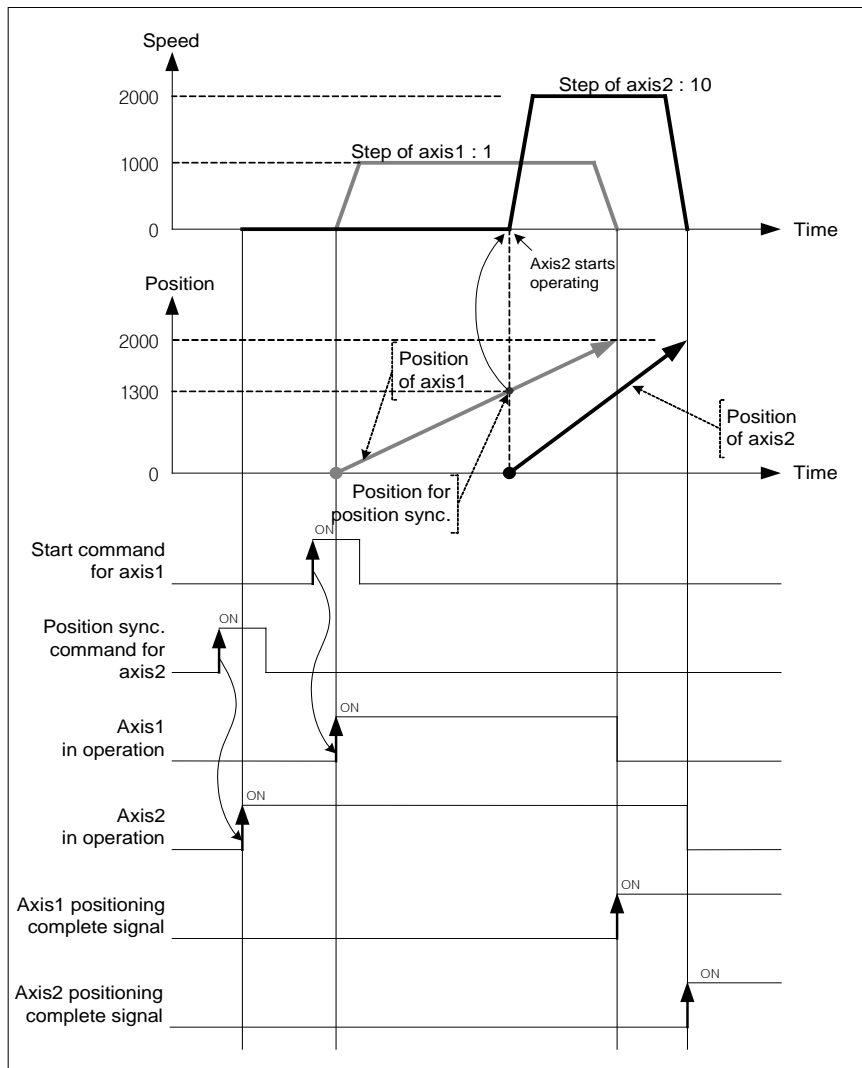

9.4.3 CAM Operation

This is the command that convert mechanical work to CAM data displayed with CAM curve and then execute CAM axis control synchronizing with the position of main motor.

(1) Characteristics of Control

(a) Replace existing mechanical work of CAM with software CAM operation

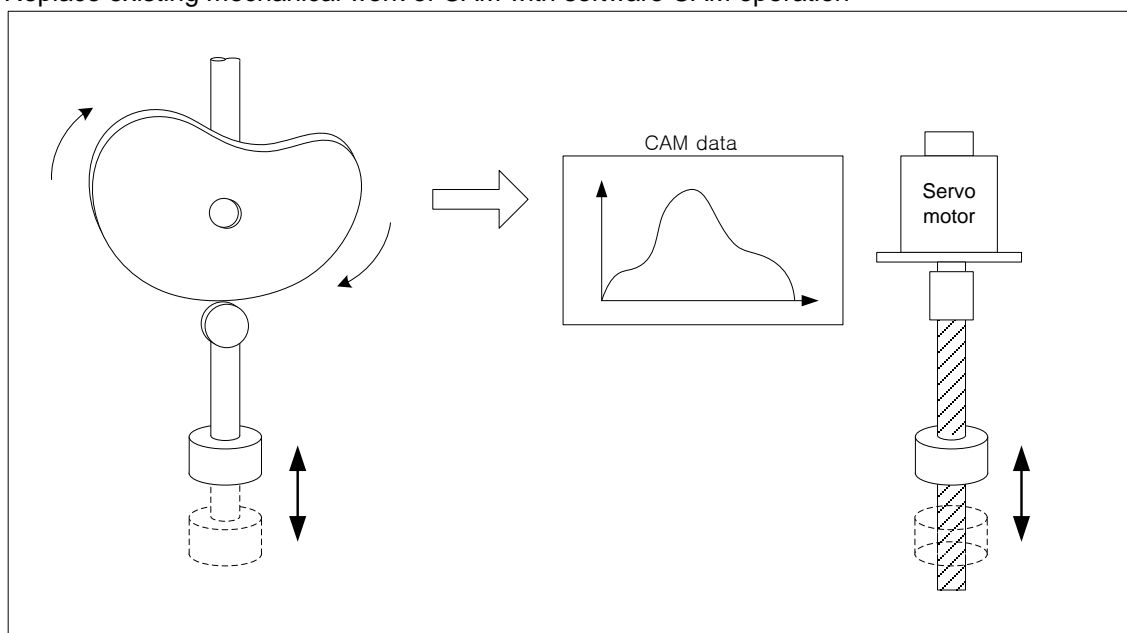

(b) You may write max. 9 CAM data blocks and apply it to each axis.

(c) Each block consists of 2048 CAM data.

(d) Auxiliary data of CAM command

Auxiliary data used in CAM command is as follows.

Item	Setting value	Description
Main Axis	1(Axis1) ~ 8(Axis8), 9(Encoder)	Set the main axis of CAM operation
CAM block	1(no.1) ~ 9(no.9)	Set CAM block no.
Main axis offset	-2147483648 ~ 2147483647	Set the position of main-axis position as offset value if main-axis reaches this position, the sub-axis starts CAM operation.

Encoder can not be used as main axis.

You may set different CAM block no. for each axis. In addition, it is possible to execute CAM operation with the same CAM block. In order to use user CAM operation, you have to set up CAM block number as 9.

(e) You can make sub-axis start the CAM operation at the specified position of main-axis by setting the "Main axis offset". Main axis offset setting is available at "Offset specified CAM start command (XCAMO, XPM_CAMO).

(f) Create CAM data by setting CAM parameter on XG-PM to use CAM.

(g) After main axis is operated, input the calculated value per CAM block setting and point unit based on the current value per rotation of main axis. For the detail description, refer to "(3) Principle of CAM operation".

(h) If CAM operation is executed on sub axis, it become 'operating status' and keep executing CAM operation with CAM data according to the position of main axis until stop command.

Remark

Maximum/minimum setting value of encoder1 of common parameter set so as to satisfy the following condition when CAM operation used encoder to main axis

$$[\text{Maximum value of encoder1} - \text{Minimum value of encoder1}] \geq [\text{Input speed of maximum pulse of encoder(pps)} \times \text{control period (s)} \times 2 \times 1.1]$$

※ Control period according to number of axes connected to the network is as follows.
 1~2 axes: 1ms, 3~5 axes: 2ms, 6~8 axes: 3ms

Ex) If the axes connected to the network are 4, input speed of maximum pulse of encoder is 100kpps, maximum value/minimum value of encoder1 can be set as follows.

$$[\text{maximum value of encoder1} - \text{minimum value of encoder1}] = 100000 \times 0.002 \times 2 \times 1.1 = 440$$

- Maximum value of encoder1 : 440
- Minimum value of encoder1 : 0

(2) CAM Parameter

The table below describes the parameter items for writing CAM data.

Item	Setting Range	Description
Main/Sub axis parameter	Unit	pulse, mm, inch, degree
	Transfer distance per 1 rotation	Depending on Unit
	No. of Pulse per 1 rotation	1 ~ 200000000
CAM control mode	Control method	Repeat, Increase
	Point unit	No. of pulse per 1 rotation
CAM block data	Starting position of main axis	Depending on Unit
	Ending position of main axis	
	Starting position of sub axis	
	Ending position of sub axis	
	CAM curve	Straight Line ~ 7 th curve

(a) Main/Sub parameter setting

1) Unit

Set the control unit of main/sub axis. Set the same as the value already set on "Unit" of basic parameter.

Item	Setting Range	Remarks
Unit of main axis	pulse, mm, inch, degree	-
Unit of sub axis	pulse, mm, inch	Degree may not be used.

2) Transfer distance per 1 rotation

Set the transfer distance per 1 rotation of main/sub axis. The unit of transfer distance is according to 1).

If the unit is "mm" or "inch", this value is the maximum last position of main/sub axis.

Transfer distance per 1 rotation is depending on unit.

■ Setting range for transfer distance per 1rotation

Unit	Setting Range	Remarks
pulse	-	No need to set
mm	0.1 ~ 20000000.0 um	The maximum last position of main/sub axis
inch	0.00001 ~ 2000.00000 inch	The maximum last position of main/sub axis
degree	360.00000 Fixation	No need to set The maximum last position of main/sub axis

3) No. of pulse per 1rotation

Set the no. of pulse per 1rotation of main/sub axis.

If the unit is "pulse", the value is the maximum last position of main/sub axis.

(b) CAM control mode setting

1) Control method

Set the form of CAM repeat pattern. "Repeat mode" and "Increase mode" may be set.

▪ Repeat (Two-way mode)

Execute round-trip motion repeatedly in the range already set from starting position of sub axis to ending position according to the position of main axis in 1 rotation.

When CAM data is created in repeat, the ending position of the last step of sub axis user last set must be set as 0.

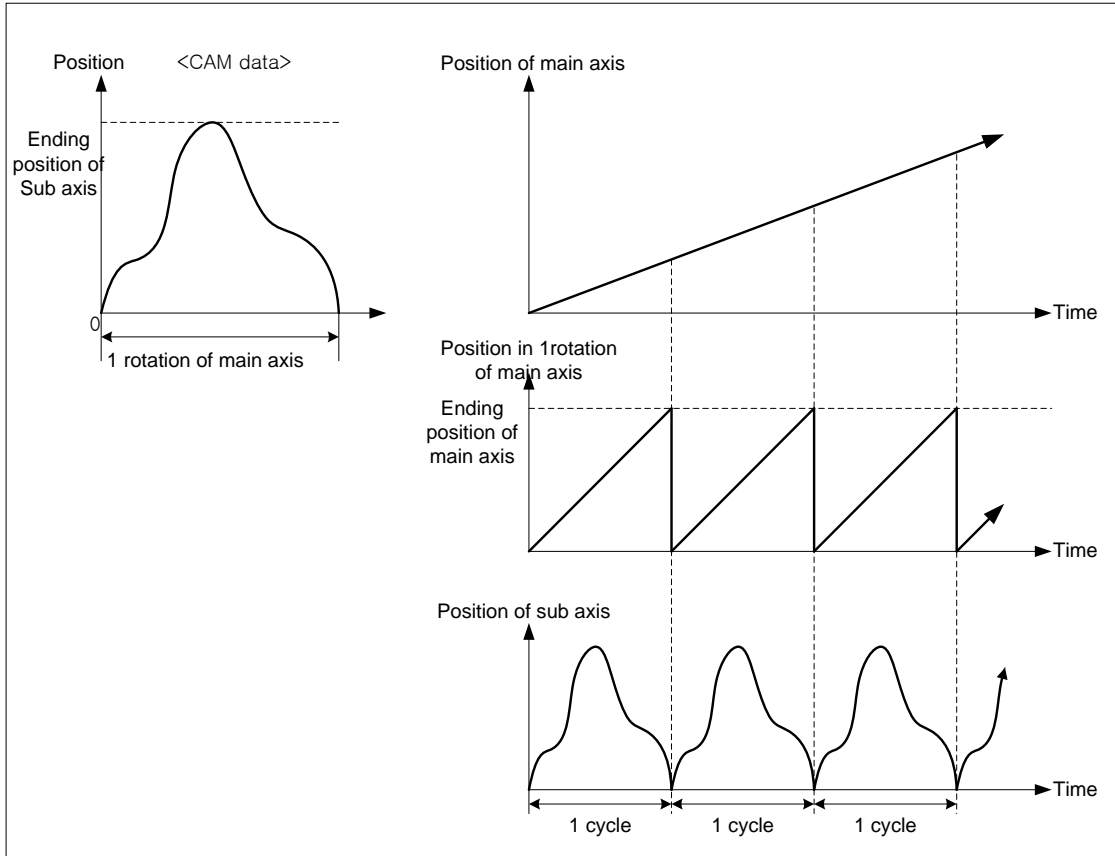

▪ Increase (Feed mode)

Execute CAM operation from starting position of sub axis to ending position according to the position in 1rotation of main axis.

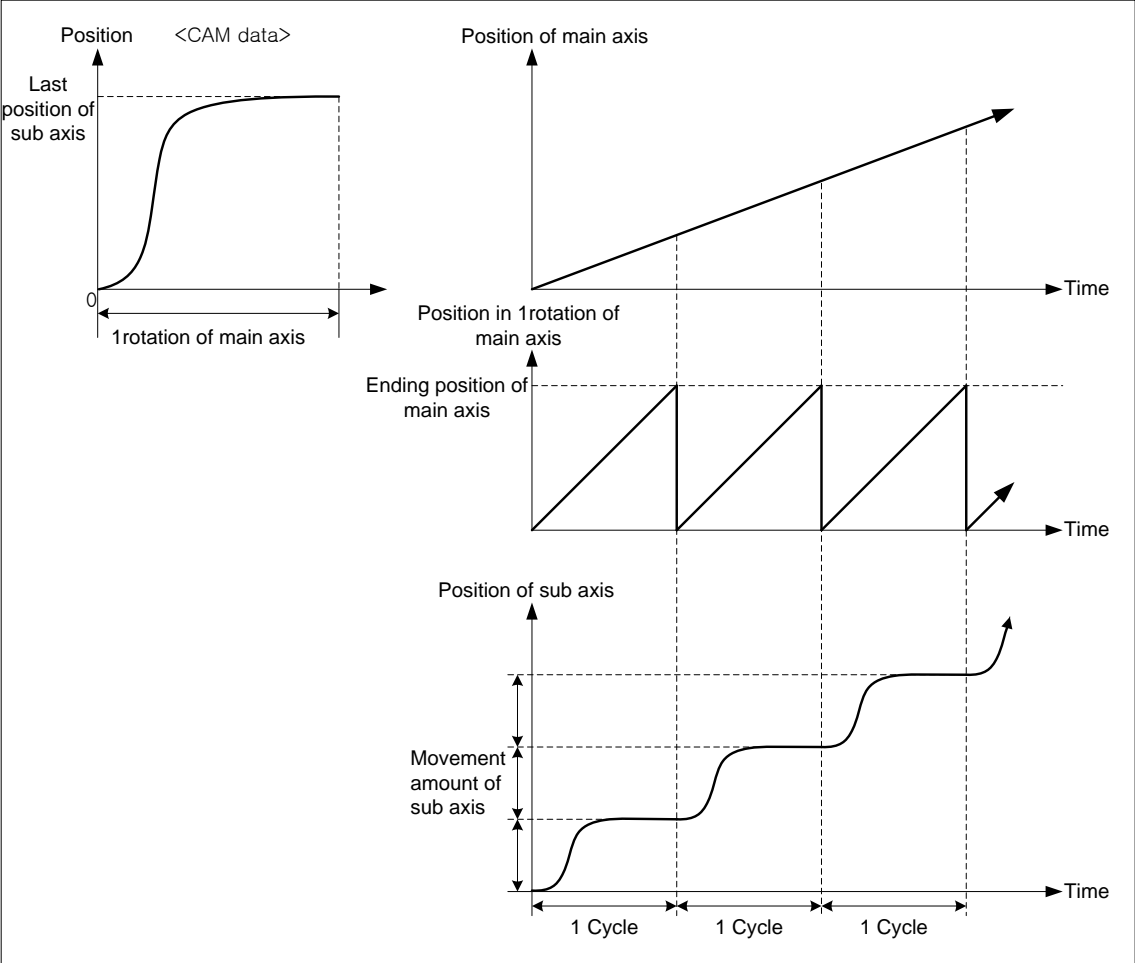

2) Point unit

Set the resolution ranging from starting position of main axis to ending position of main axis on each step data of CAM block data setting. When CAM data is created, calculate the position of sub axis corresponding to the position of main axis from the starting position of main axis by point unit. The smaller point unit is, the more no. of CAM data is, so you may execute much smoother CAM operation. However, if point unit is small, no. of CAM data exceeds 2048, so there is a chance that user can not create CAM data.

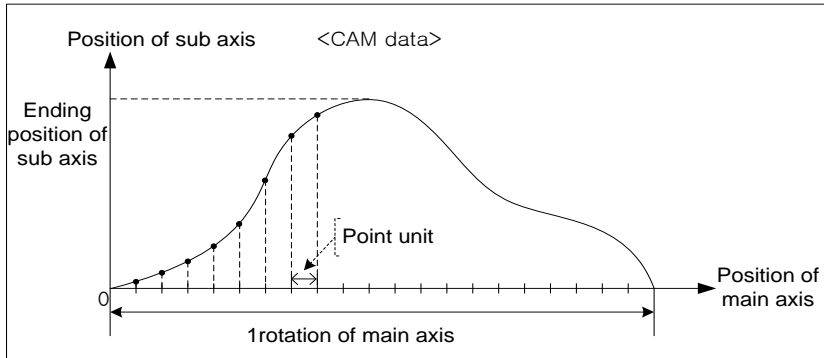

Remark

When set CAM block data after point unit setting, "Ending position of main axis" must be set as positive multiple number of point unit. For example, if the unit of main axis is "degree" and point unit is 10, "Ending position of main axis" must be set as multiple number of 10 like 40, 90, 180, ...

(c) CAM block data setting

20 data sections may be set in a CAM block and every section may have specific curve.

1) Starting position of main axis

Set the starting position of main axis in designated section. Starting position of main axis is the same as the ending position of main axis in previous section.

2) Ending position of main axis

Set ending position of main axis in designated section. The ending position of main axis in the last section must be set as much as the transfer distance per 1 rotation set on main/sub axis parameter.

3) Starting position of sub axis

Set the starting position of sub axis corresponding to the starting position of main axis in the designated section. Starting position of sub axis is the same as the ending position of sub axis in previous section.

4) Ending position of sub axis

Set ending position of sub axis corresponding to the ending position of main axis in the designated section. If control method is "Repeat (Two-way mode)", the ending position of sub axis in the last section must be 0. If control method is "Increase(Feed mode)", the ending position of sub axis in the last section generally has to be set as much as the transfer distance per 1 rotation set on main/sub axis parameter.

5) CAM curve



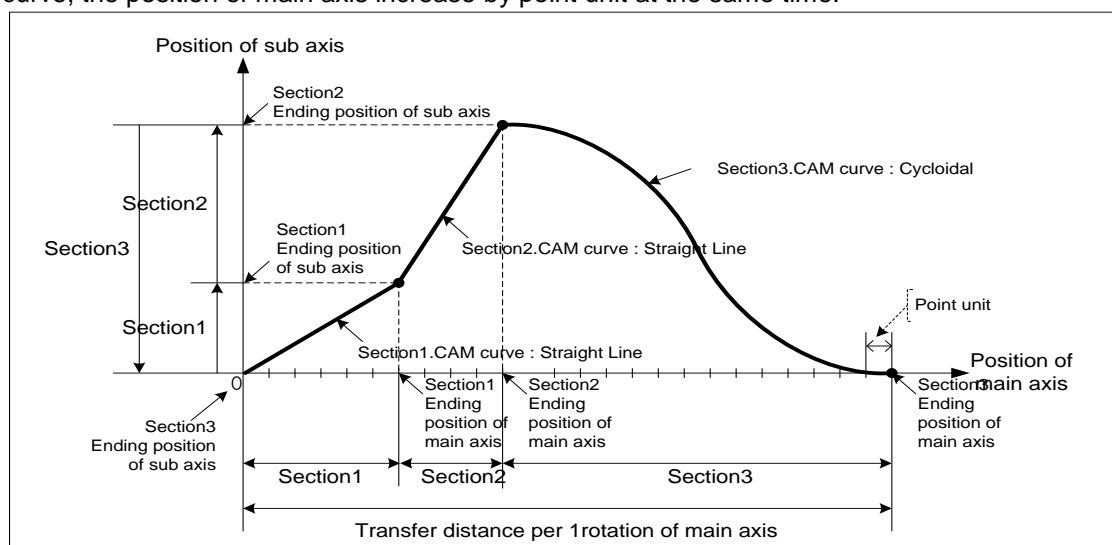







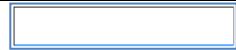



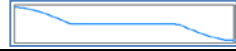

Set CAM specific curve to create data ranging from starting position of sub axis to ending position of sub axis in the designated section. The position of sub axis is calculated by characteristic of selected CAM curve, the position of main axis increase by point unit at the same time.

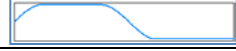
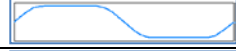

There are 22 kinds of CAM curve.

Describe characteristic of each CAM curve on next page.

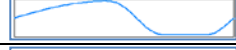
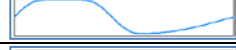
■ Characteristic of CAM curve

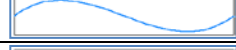
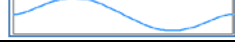
Name	Acc. type	Position (S_{max})	Speed (V_{max})	Acc. (A_{max})	Jerk (J_{max})
Straight Line		1.00000	0.00000	0.00000	0.00000
Constant Acceleration		1.00000	2.00000	4.00000	0.00000
Simple Harmonic		1.00000	1.57076	4.93409	2.46735
No-Dwell Simple Harmonic		1.00000	1.57076	4.93409	2.46735
Double Harmonic		1.00000	2.04047	5.55125	0.10285
Reverse Double Harmonic		1.00000	2.04048	9.86605	4.93455
No-Dwell Modified Constant Velocity		1.00000	1.22203	7.67383	3.83881
Modified Constant Velocity		1.00000	1.27526	8.00947	0.98712
No-Dwell Modified Trapezoid		1.00000	1.71788	4.19885	2.09942
One-Dwell Modified Trapezoid		1.00000	1.91589	4.43866	55.77788
Modified Trapezoid		1.00000	1.99975	4.88812	0.30562
Asymmetrical Modified Trapezoid		1.00000	1.99982	6.11015	0.47620
One-Dwell Cycloidal		1.00000	1.75953	5.52756	0.17345
Cycloidal		1.00000	1.99985	6.28273	0.19715
Asymmetrical Cycloidal		1.00000	1.99989	7.85304	0.30783
One-Dwell Trapezoid		1.00000	1.73636	4.91007	0.30699
Reverse Trapezoid		1.00000	2.18193	6.16975	0.38579
Trapezoid		1.00000	2.18193	6.17044	0.38579
One-Dwell Modified Sine		1.00000	1.65978	5.21368	0.32603
Modified Sine		1.00000	1.75953	5.52697	0.34562
5th Curve		1.00000	1.87500	5.77350	60.00000
7th Curve		1.00000	2.18750	7.51283	41.99646

(3) Principle of CAM operation

- (a) When CAM operation command is executed, the current position of main axis is recognized as 0.
- (b) When the main axis starts operating, “the current position in 1rotation of main axis” increase to “no. of pulse per 1rotation (-1)” then become 0. The position value (0~“no. of pulse per 1rotation (-1)”) is repeated.
- (c) Calculate CAM data step no. corresponding to “the current position per 1rotation” with “point unit” of CAM parameter.

$$\text{Cam Data Step no.} = \frac{\text{Current Positio per 1rotation of Main Axis}}{\text{Point Unit}}$$

For example, if the position of main axis at the beginning of CAM operation is 1000, the current position is 1073 and point unit is 10, the step no. of CAM data is as follows.

$$\begin{aligned} \text{Cam Data Step no.} &= \frac{\text{Current Positio per 1rotation of Main Axis}}{\text{Point Unit}} \\ &= \frac{1073 - 1000}{10} \\ &= 7.3 \end{aligned}$$

(d) Calculate update position of sub axis with CAM data step. If main axis is forward direction, calculate the position of sub axis with the position corresponding to “the part of positive number of CAM data step no.” and the position corresponding to “the part of positive number of CAM data step no. +1”.

$$\begin{aligned} &\text{Position of sub axis} \\ &= \{(\text{Step position of CAM data} + 1) - (\text{Step position of CAM data})\} \times \text{Decimal part of CAM data step no.} \\ &\quad + (\text{Step position of CAM data}) \end{aligned}$$

For example, if position value of sub axis of step 7 is 395 and step 8's is 475, the position of sub axis is as follows.

$$\begin{aligned} \text{Position of sub axis} &= 395 + (475 - 395) \times 0.3 \\ &= 395 + 24 \\ &= 419 \end{aligned}$$

(4) Operation timing
 (a) General CAM start command

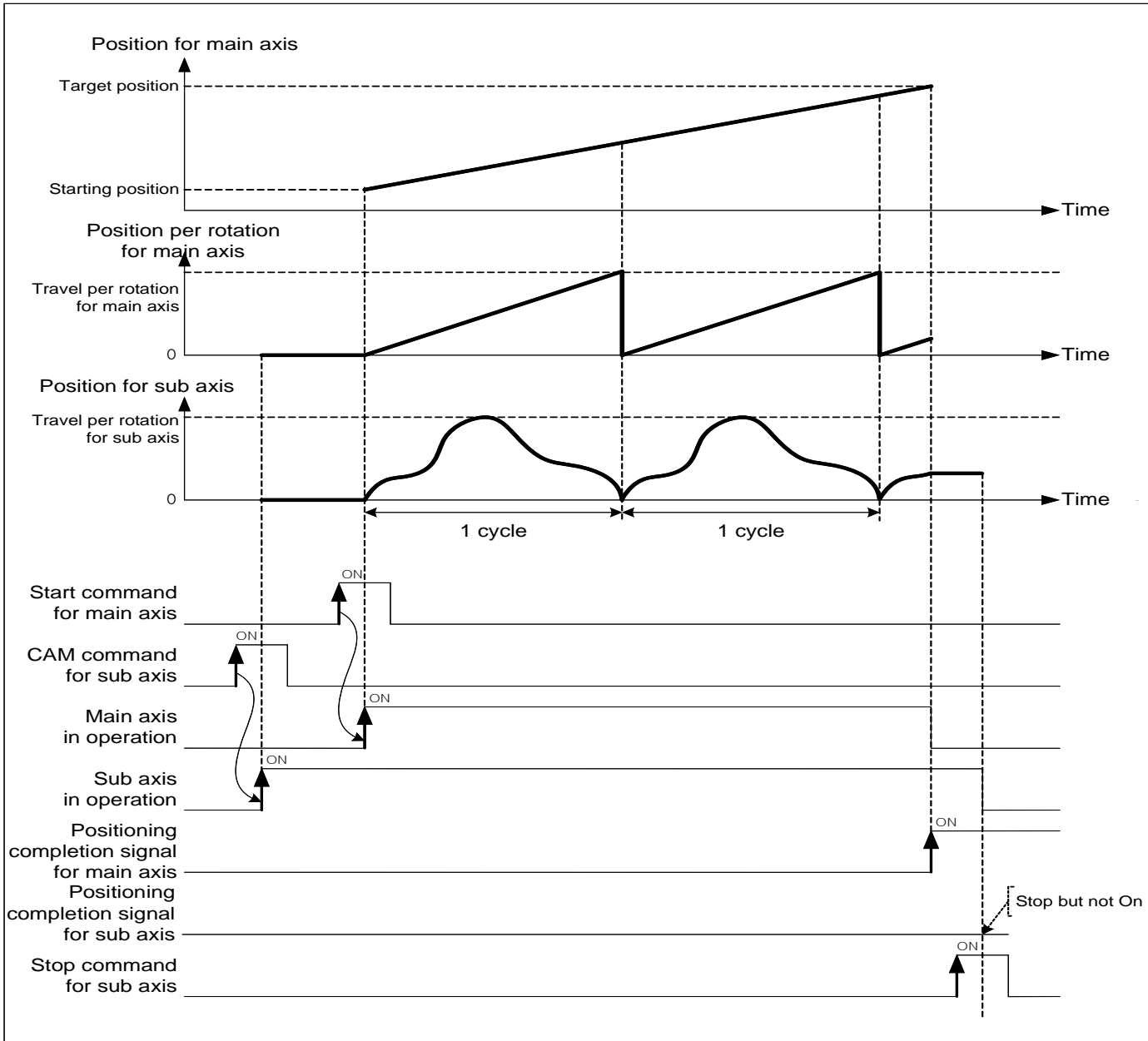

(b) Main-axis offset-specified CAM start command

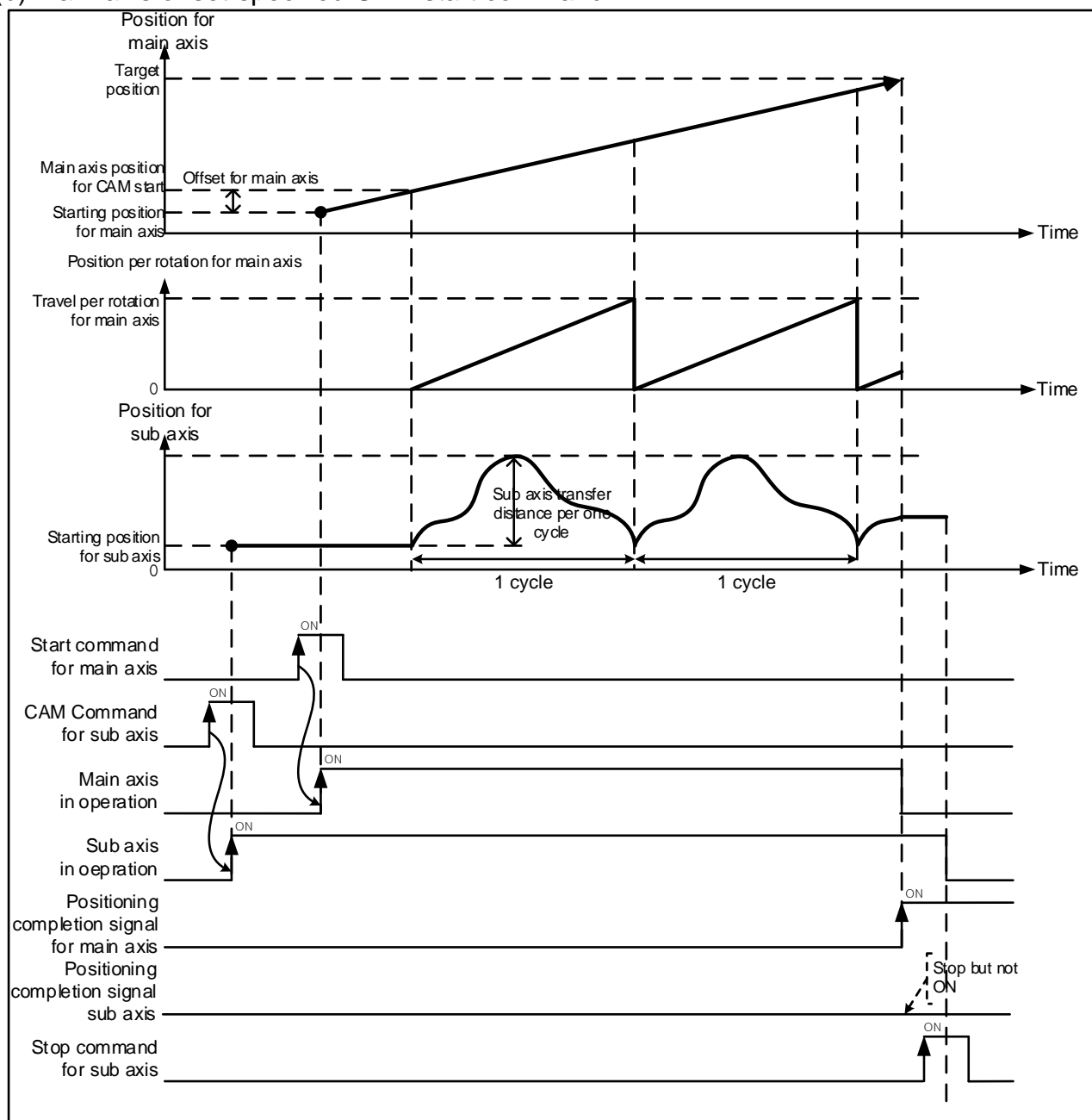

(5) Restrictions

CAM operation command may not be executed in the cases below.

- If execute CAM operation command in being On of M code, error (code:702) arises. Make M code "OFF" with "M code release (XMOF)" command before use.
- If the current main axis is not the axis can be set on the current module or main axis and command axis are the same axis, error (code:704) arises. Set the main axis among one of the axis can be set on module.
- If speed of main axis is too fast and speed of sub axis exceeds speed limit, error (code:708) arises. In this case, you have to lower the operation speed.

(6) Additional function of CAM operation

The following are additional function related to the CAM operation.

(a) The function to stop after finishing cam cycle of operation when cam operation is stopped.

1) Execution method

The deceleration stop of deceleration stop command(XSTP) set to 2,147,483,467, when you execute the deceleration stop command during CAM operation, it will stop when the cam cycle was currently in operation is finished.

2) Program example

a) XGK

■ Installed slot of positioning module: 0 base 2 slot, Axis of CAM operation : 2 axis, time of deceleration stop : 2,147,483,647

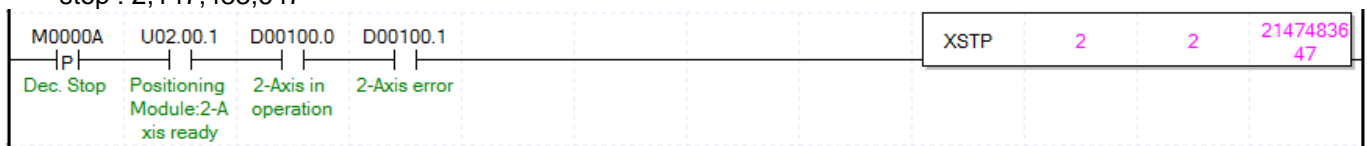

It is created assuming that saving the state information of axis 2 at D00100 by using the XSRD command.

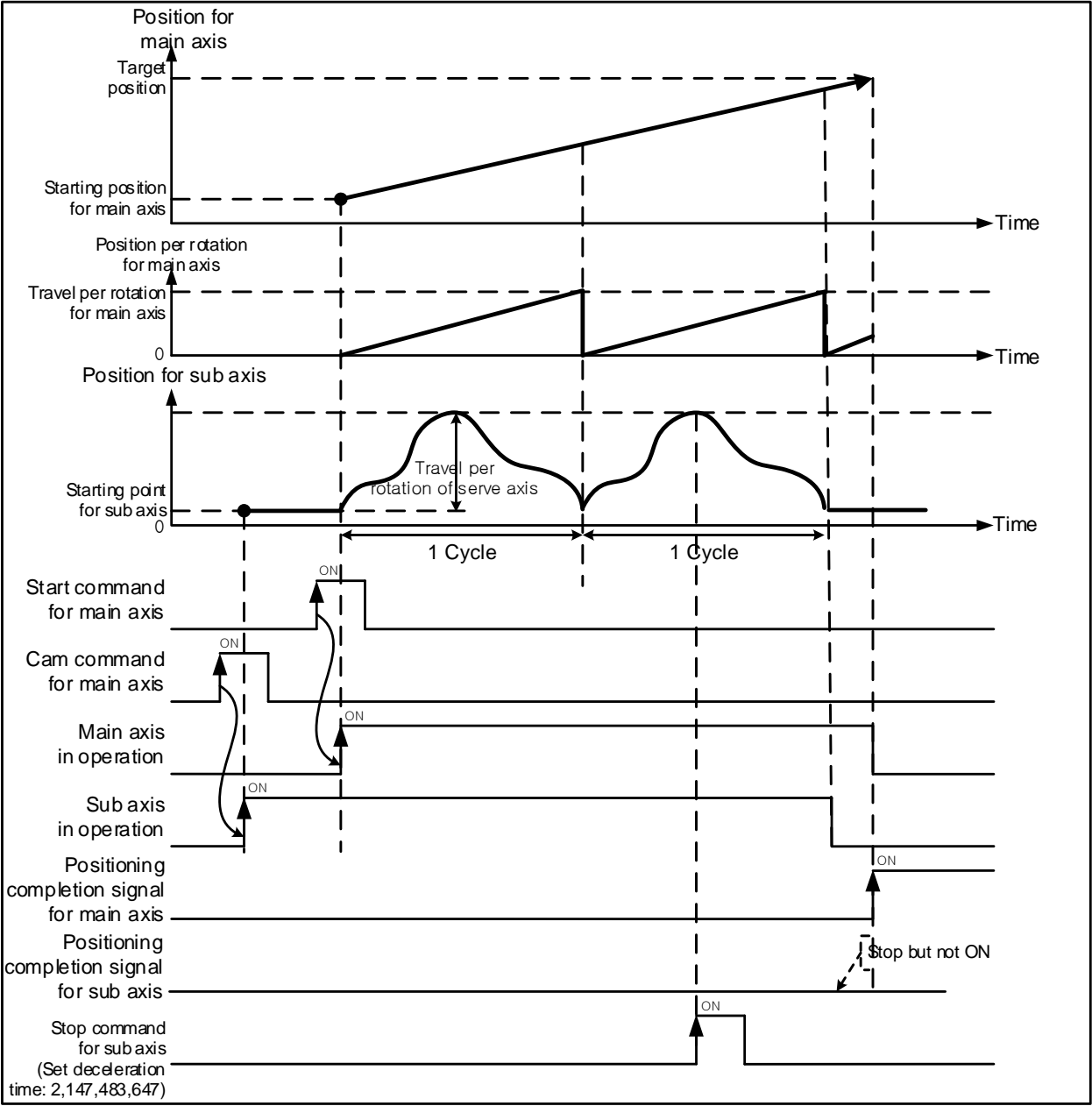

(b) Flag of cam period

Cam cycle flag turned on each time when 1 cycle of the cam operation is completed. And it turned off after the time that was set at the complete time of positioning.

Cam cycle flag can be monitored by using XSRD command(read the operation status) and GET command.

1) Contents of each bit of axis information

Memory address								Contents
1Axis	2Axis	3Axis	4Axis	5Axis	6Axis	7Axis	8Axis	
2C2	342	3C2	442	4C2	542	5C2	642	Axis information

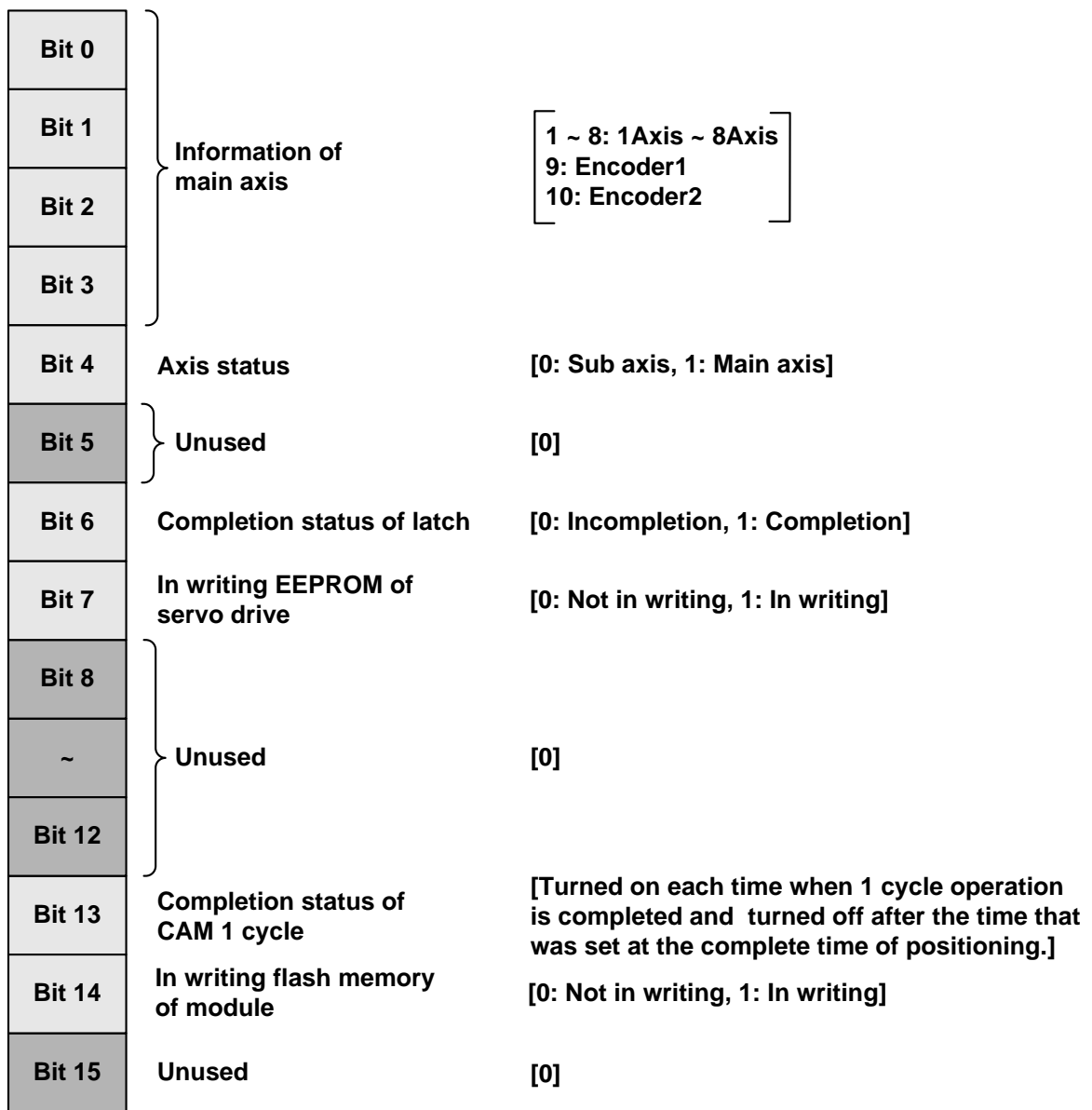

2) motion timing of cam cycle flag

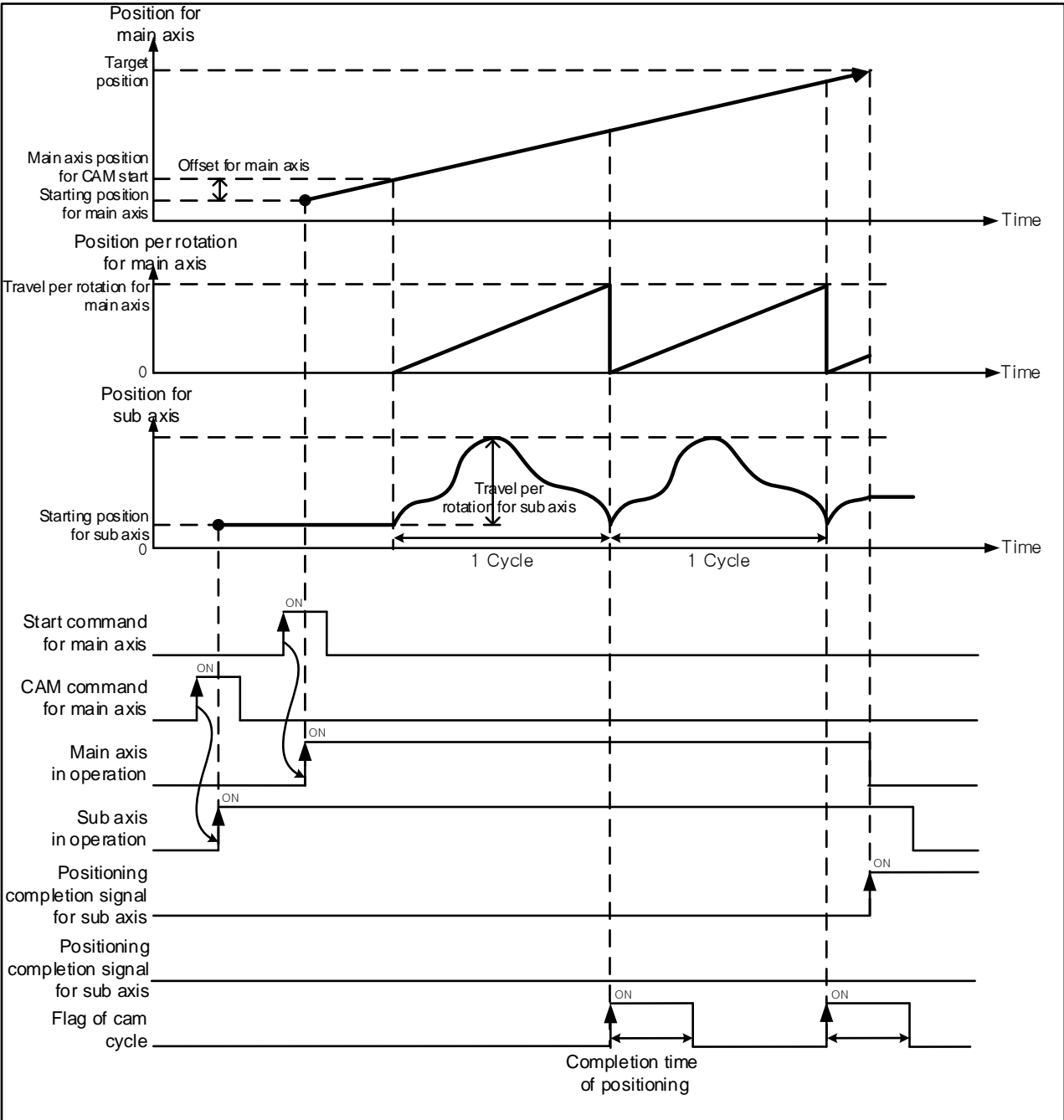

Remark

The time maintaining that cam cycle flag turn on will be applied the time that has been set to "positioning complete time" of extended parameters.

(c) CAM restart function

If you re-execute the cam operation at stop position in case that main/sub axis of cam operation is stopped by error and EMG.stop, it operates CAM restart.

1) Condition of execution

- a) 'CAM restart operation' item of extended parameter is set to '1: Enable'.
- b) If you re-execute the cam operation in case that axis of cam operation is stopped by error and EMG.stop, it operates CAM restart.
- c) After the cam operation axis is stopped by EMG.stop, it doesn't have any cam restart operation be performed if cam operation command is executed again when it is changed to the homing start/floating origin setting/preset of current position/status of undetermined origin.
- d) CAM restart doesn't work in case that CAM operation is executed after sub axis is stopped by deceleration stop.
- e) If the main axis is encoder, be careful encoder axis doesn't move because position change of encoder isn't reflected to synchronization position movement of sub axis when operating to synchronization position of sub axis about main axis position after restart.

2) Motion timing of CAM restart

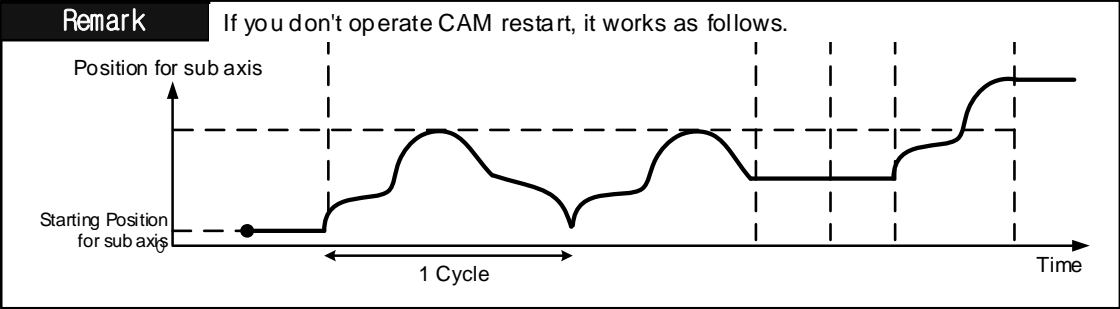
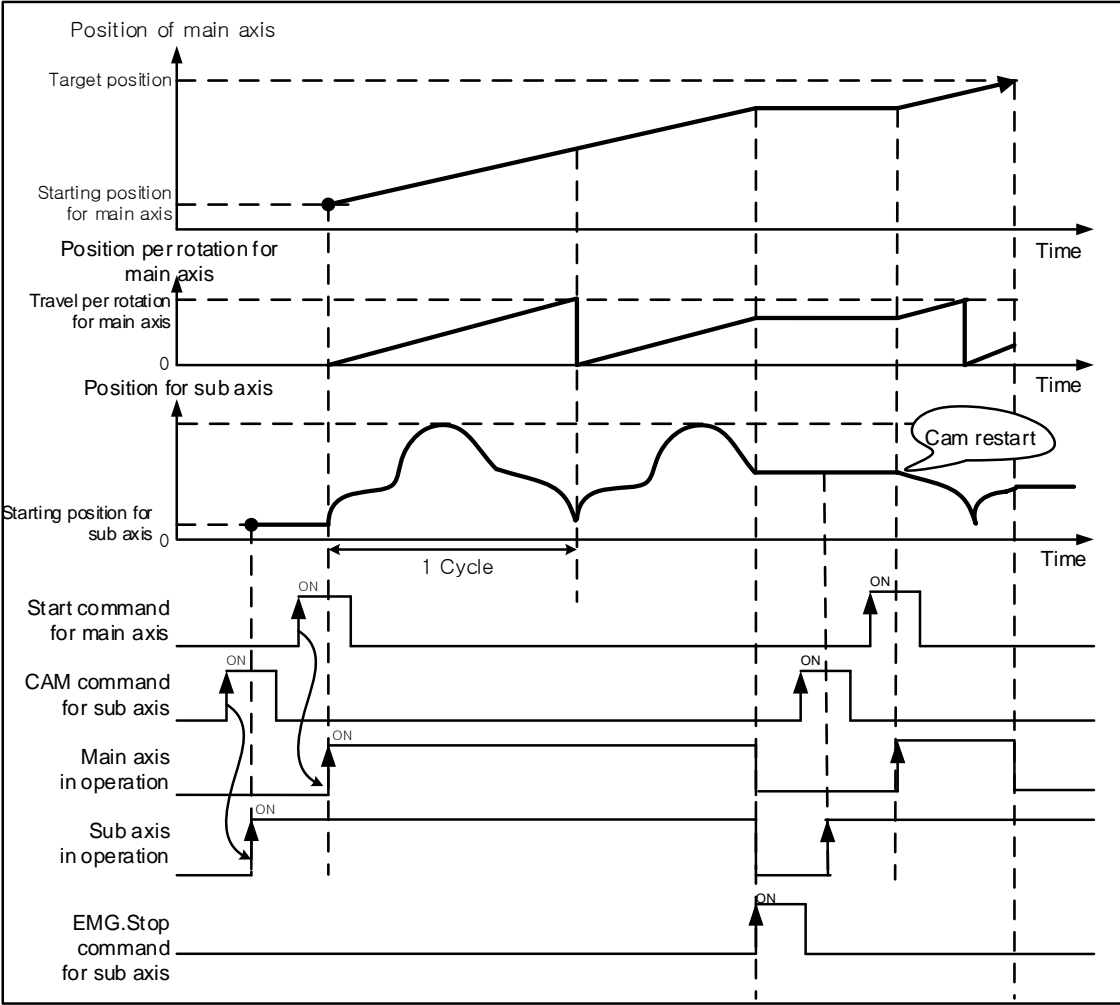

9.4.4 User CAM Operation

User CAM operation, like CAM operation, executes CAM axis control in which CAM data shown as CAM curve synchronize with position of the motor set as main-axis. The difference with CAM operation is that user sets up CAM data not in XG-PM but in PLC program (XG5000), and the number of CAM data is 30.

(1) Operation

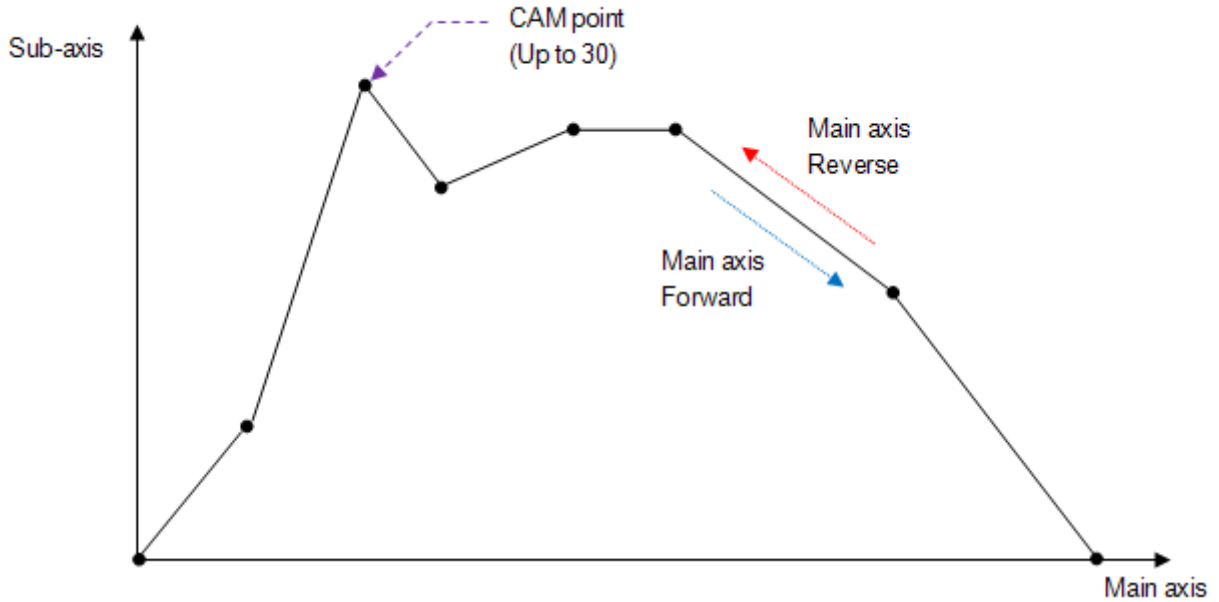

Like figure above, you can set up maximum 30 CAM data points, and it operates CAM curve between CAM points with straight line. CAM point data is set up at sub-axis and as type of (main-axis position, sub-axis position). CAM data point can be saved at the specified memory address of each axis by using XVWR command. For memory address to save CAM data point of each axis, refer to appendix 2.11 User CAM data memory address.

Remark

You can change the user cam data by write command of variable data(XVWR, XPM_VWR) during user cam operation. The time the changed user cam data is reflected is later cycle of user cam data currently running is completed.
It can be used for applications that need to operate by changing the cam pattern without stopping during the user cam operation.

9.4.5 Phase correction control

Phase correction control is the function that performs correcting phase for executing synchronous control of main axis. While acting synchronous control, it executes virtual positioning move (correcting phase) about the main axis position being synchronized with sub-axis. So the sub-axis executes synchronous control about position of the moved main-axis.

(1) Features of control

- (a) Phase correction command can be executed about axis being synchronous operation such as speed synchronous or CAM control.
- (b) Although the phase correction command is executed, the position of the command for main axis and the current position don't change. When operating synchronous control for sub-axis, phase correction is executed with calibrated value for main axis position to refer.
- (c) The position of main-axis referring sub-axis with synchronous operation will be set "real main-axis position + phase correction control position".
- (d) The phase correction speed is operated by relative velocity for the currently main-axis speed.
- (e) Trapezoid or s-curve operation is executed by the acceleration or deceleration patterns of main-axis.
- (f) In case main-axis is encoder, when execute the phase correction control it is executed by using speed limit and the acceleration or deceleration patterns of sub-axis.
- (g) When command is re-executed with operating phase correction, the phase correction is executed as much as correcting size at that point. In other words, phase correction amount is additional operations as a relative value.
- (h) When phase correction size is set as 0 with re-executing phase correction, existing operation will stop directly. (The phase correction operation status change to Off)

(i) The assistance data for phase correction command

The assistance data that is used for the phase correction command is shown below.

Item	Set value	Description
Main-axis	1(1Axis) ~ 8(8Axis), 9(Encoder1)	Set the main-axis of the phase correction control.
Phase correction amount	-2,147,483,648 ~ 2,147,483,647	Set the position correction amount to execute phase correction.
Phase correction speed	0 ~ 2,147,483,647	Set the target speed as relative velocity of the main-axis velocity.
Acceleration time	0 ~ 2,147,483,647(ms)	Set the acceleration time for the speed limit of the main-axis.
Deceleration time	0 ~ 2,147,483,647(ms)	Set the deceleration time for the speed limit of the main-axis.

(2) Operation Timing

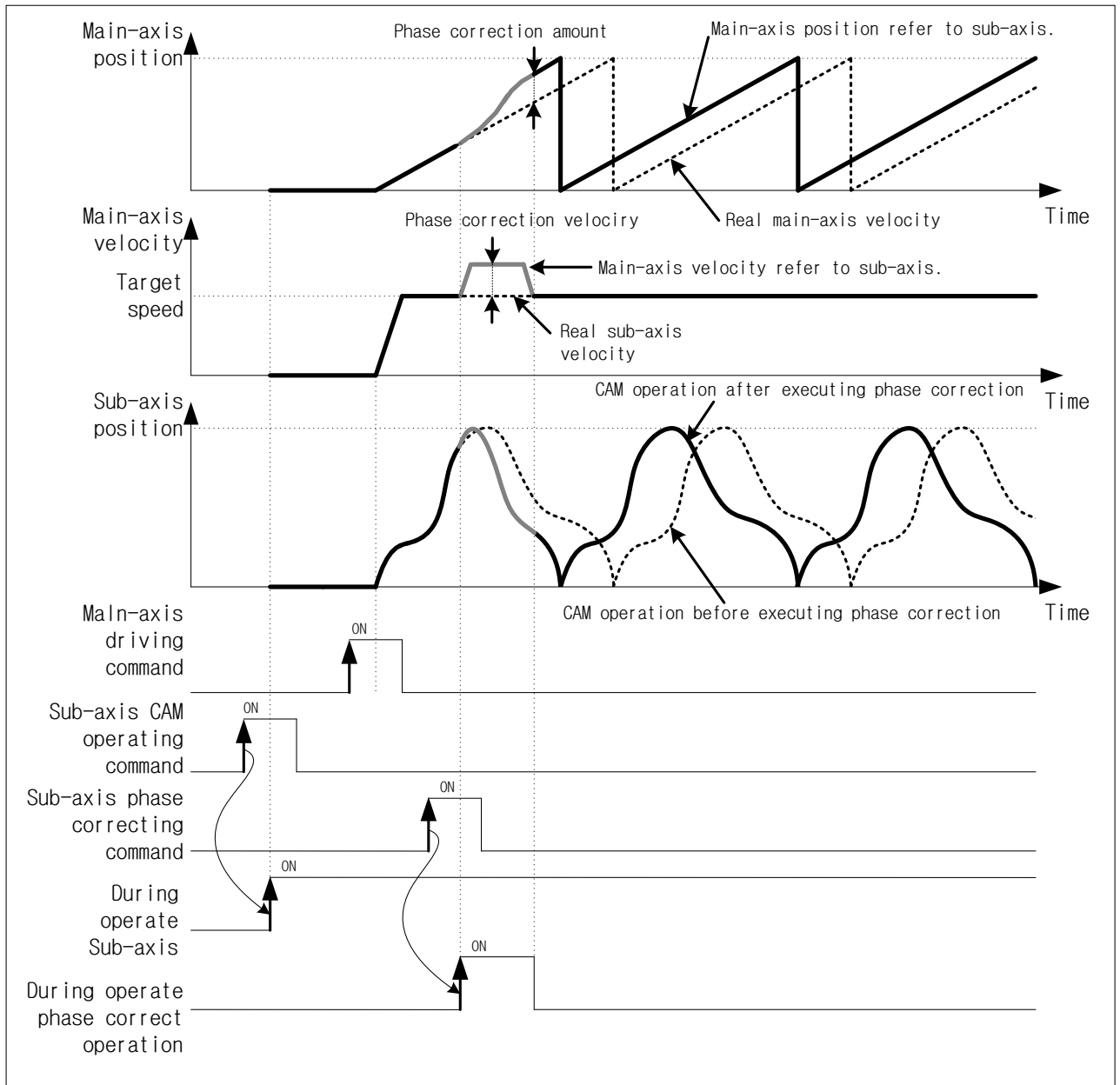

(3) Restriction

For the following is considered as an error, it can't execute the phase correction control.

- (a) When phase correction command is executed with non-synchronous control (Speed synchronization, CAM) of sub-axis, error code (771) is generated.
- (b) When the phase correction amount of phase correction is set as out the range of pulse unit expression (-2,147,483,648~2,147,483,647), error code (771) is generated.
- (c) When the velocity of phase correction is set as below to 0 or exceeding the speed limit, error code (774) is generated.
- (d) When the acceleration time of phase correction is set as out the range (0~2,147,483,647), error code (775) is generated.
- (e) When the deceleration time of phase correction is set as out the range (0~2,147,483,647), error code (775) is generated.

9.4.6 Operating the Absolute Position CAM

Absolute Position CAM operation allows the cam to synchronize to the absolute position of the main axis.

(1) Control Characteristics

Once the command for Absolute Position CAM operation (XCAMA, XPM_CAMA) is executed, the main axis will move to the synchronization position by moving the distance set in `STRT_DST`. The synchronization position is the position of the longitudinal axis according to the cam data value set in the cam block, which is located at the position of the main axis that has moved the distance set in `STRT_DST`. The synchronization position of the main axis may move according to `SLV_OFFSET` and `MST_OFFSET` values. Once the main axis reaches the distance set in `STRT_DST`, cam operation is performed according to the cam data values set in the cam block.

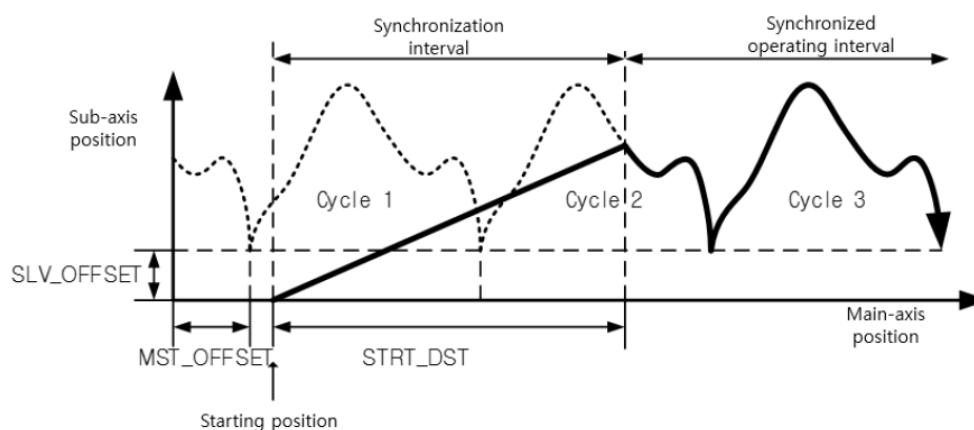

(2) Parameters of Absolute Position CAM

Category	Setting values	Description
Main axis	1 (1 axis) - 8 (8 axes), 9 (Encoder1)	Sets the main axis for cam operation.
Cam block	1 (no. 1) - (no. 9)	Sets the number of the cam block.
Start distance	-2147483648 - 2147483647	Sets the starting position of absolute position cam operation.
Main axis offset	-2147483648 - 2147483647	Sets the position of the main axis where the longitudinal axis starts cam operation at an offset value at the main axis position.
Longitudinal axis offset	-2147483648 - 2147483647	Sets the position of the main axis where the longitudinal axis starts cam operation at an offset value at the longitudinal axis position.

- The encoder can be used as the main axis of absolute position cam operation.
- Different cam block numbers can be set for each axis. Also, cam operation of different axes is possible with one cam block.
To use the user CAM operation, the cam block number must be set to 9.
- You can change the position of the main axis where cam synchronization starts upon cam command execution by setting the starting distance (`STRT_DST`). If the starting distance is set to a small value, the longitudinal axis may operate suddenly once the absolute position cam operation is executed and could result in a shock.
- You can change the starting position of the longitudinal axis cam operation by setting the main axis offset and the longitudinal axis offset.

(3) Restriction

The absolute position cam operation command cannot be executed under the following conditions, which are interpreted as errors:

- (a) If the cam operation command is executed during a state where the M code signal is ON.
(Error code 702) Change the M code signal to OFF by using the M code disable command (XMOF).
- (b) If the axis set as the main axis is not currently connected to the network or if the main axis settings is identical to the command axis. (Error code 704) Set the main axis from the axes that are currently connected to the network.
- (c) If the calculated speed of longitudinal axis at the service axis position of the cam operation data exceeds the speed limit due to the high speed of the main axis. (Error code 708) Make sure to lower the operation speed of the main axis so that the longitudinal axis does not exceed the speed limit.
If the longitudinal axis exceeds the speed limit, an error occurs and it decelerates to a stop, according to Decelerationtime1 of the default parameter.

9.4.7 Operation of the synchronous speed designating synchronous position

(1) Characteristics

- (a) The synchronous speed designating synchronous position operates at the synchronous speed of the main axis (or encoder) and the sub axis set according to the same rate as the operation of synchronous speed.
- (b) You can designate the start position where the main and sub axes are synchronized.
- (c) The operation method is as the following figure:

In the following figure, MasterSyncPosition is the “synchronous position of the main axis” and SlaveSyncPosition is the “synchronous position of the sub axis”.

The start position of the main axis synchronization is a distance from the synchronous position of the main axis. For example, if the main axis synchronization is 1000, the sub axis synchronization is 1000 and the start position of the main axis is 400, the sub axis starts to operate at the position of 600 and operates at the synchronization rate that is set at the position where the main axis is 1000 and the sub one is 1000.

(2) Operation Timing

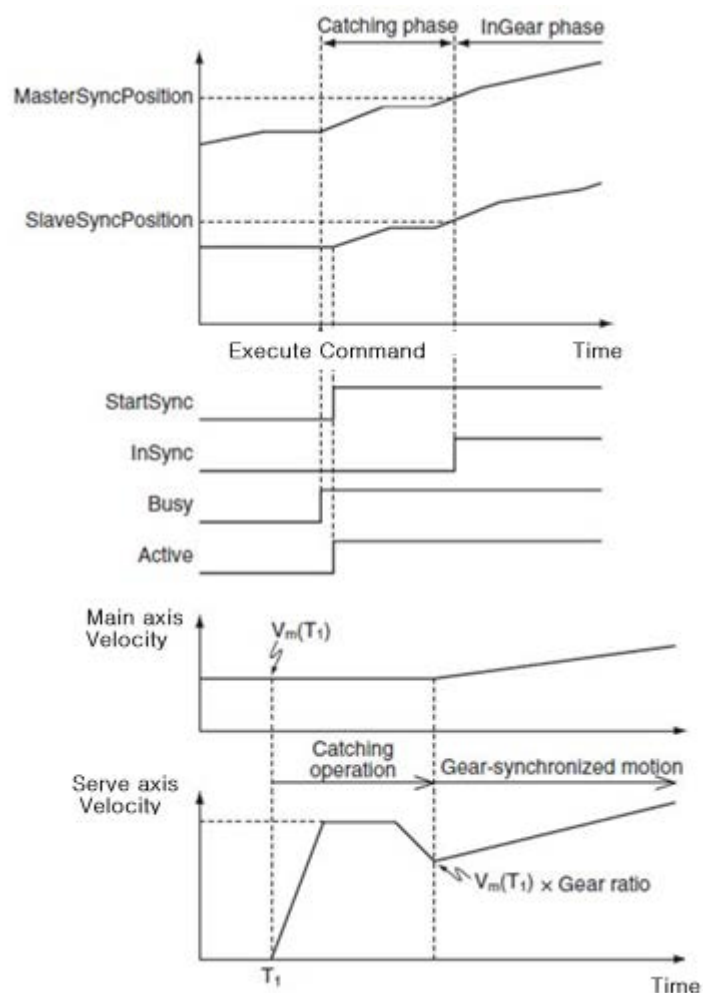

(3) Operation Example

Main Axis: 1, Sub Axis: 2,

Synchronous Rate: 1, Main Axis Sync. Position: 1000, Sub Axis Sync. Position: 1000

Synchronous Start Distance: 500

Synchronization starts from 500 position and Sub Axis catch the speed and position until Main/Sub Axis Sync. Position (1000, 1000).

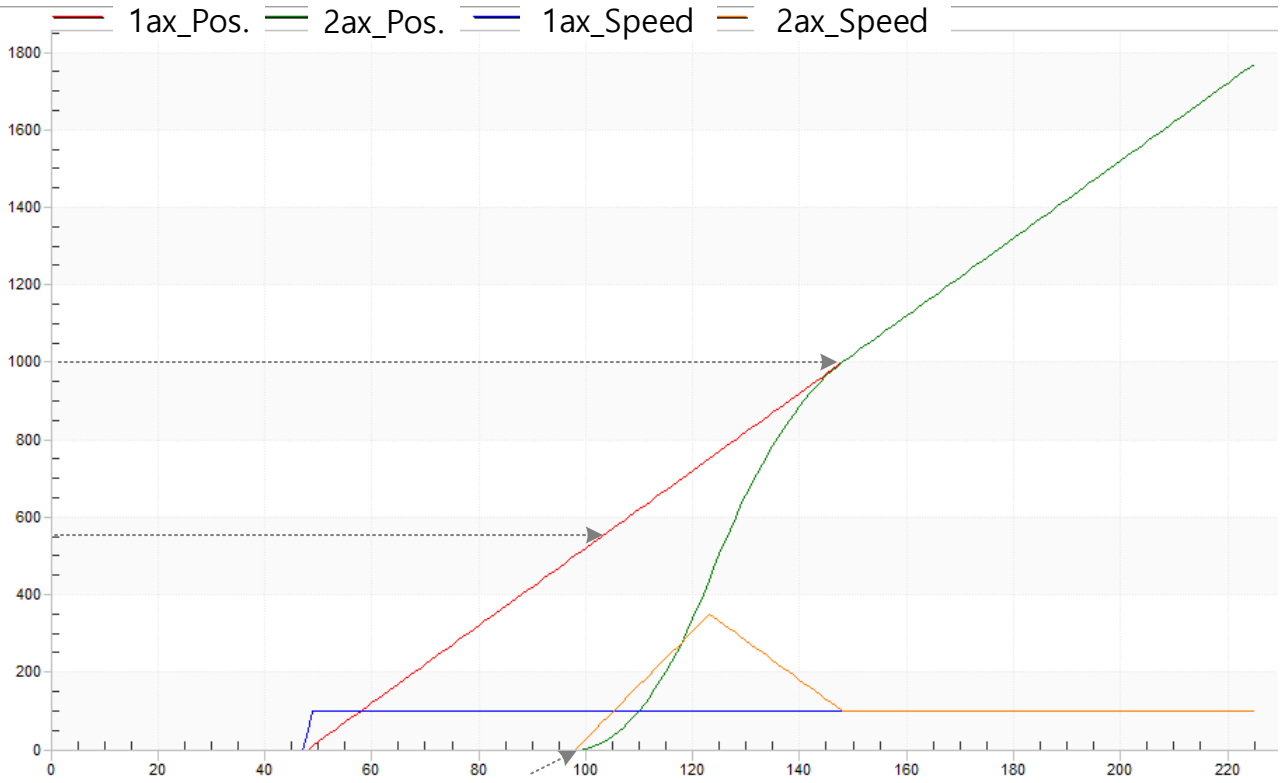

9.5 Modification Function of Control

9.5.1 Floating Origin Setting

This is used to force to set the current position as the origin without carrying out the homing action of the machine.

(1) Characteristic of Control

- (a) Modify the current position into "Homing end position" of homing parameter and become Origin-decided status.
- (b) After floating origin setting command is executed, the current position is changed to "0"
- (c) Related parameter (Homing Parameter)

Remark

Floating origin setting just executes forced origin-decision from the current position to origin completion position. So user need to take notice as follows.

- (1) When error arose, clear the cause of error and reset,
- (2) set floating origin again,
- (3) change the operation step no. to operate with start step no. change command and then execute.

(2) Operation timing

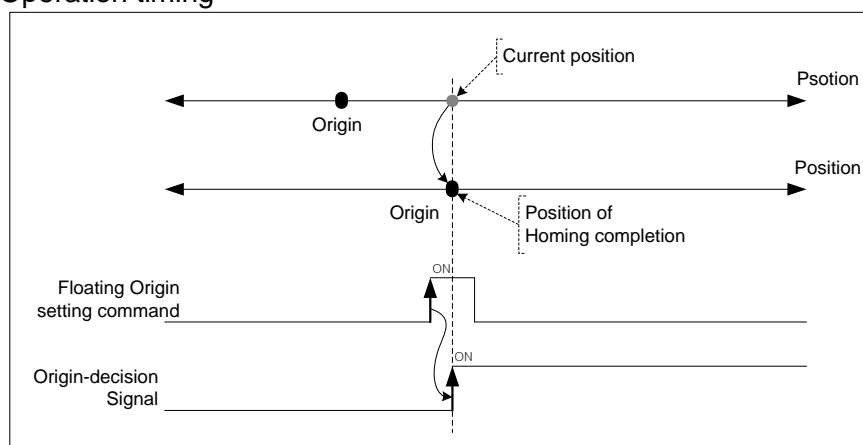

(3) Restrictions

If drive ready signal is in "OFF", floating origin setting command is not executed but error (code:212)arises. When drive ready signal is in "ON", execute floating origin setting command.

9.5.2 Continuous Operation

Execute positioning control changing the current operation step no. to the next one.

(1) Characteristics of Control

- (a) When continuous operation command is executed, operating speed is changed into the speed of next operation step directly.
- (b) This command may be used in End, Go on, Continuous mode and used at Acc.,Dec.,Steady speed section.
- (c) If continuous operation command is executed in operation, the current operation step no. is changed to the next step no. and keep operating.
- (d) There are differences of operation depending on between absolute coordinates and relative coordinates.

(2) Operation timing

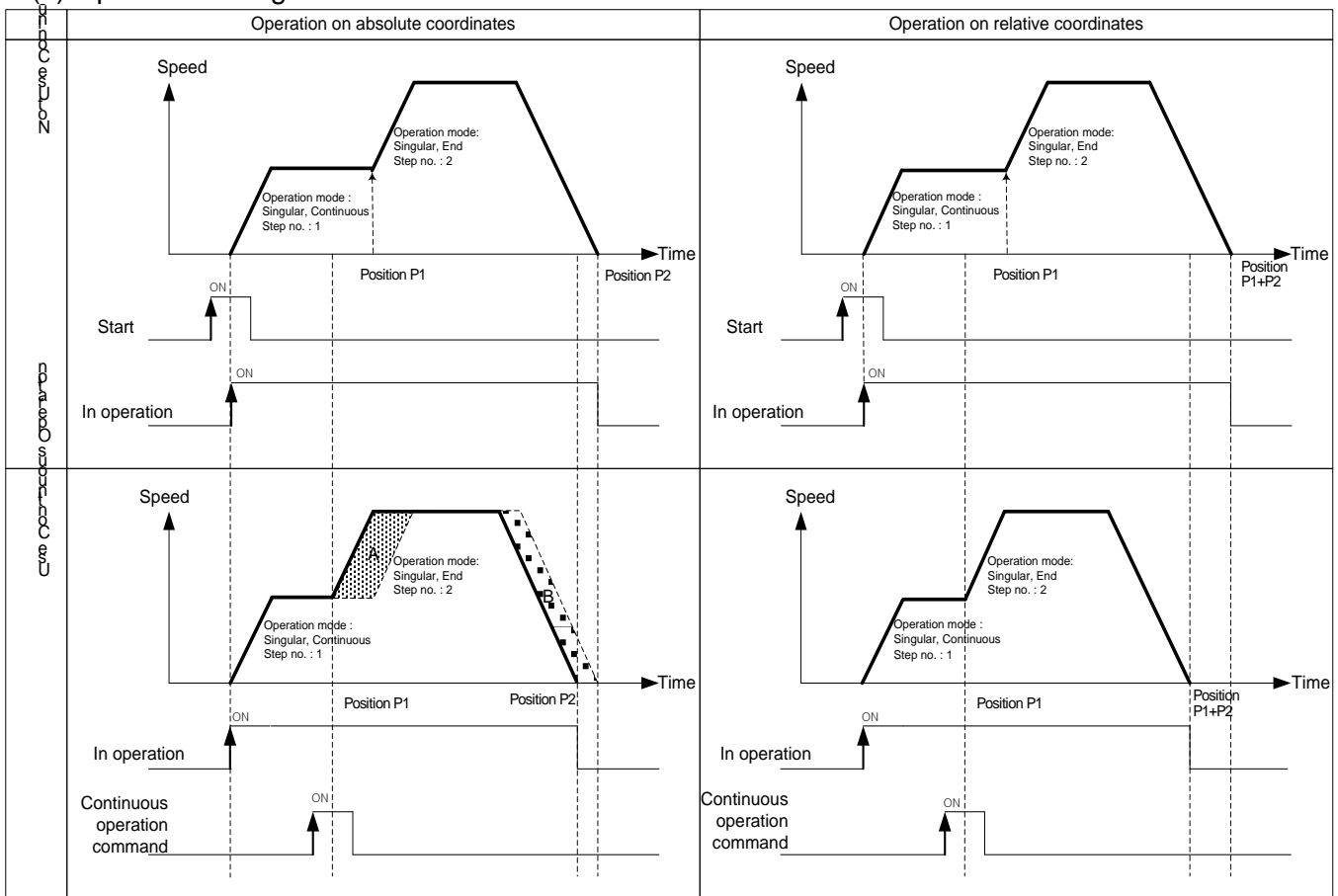

- The goal positions of continuous operation on absolute coordinates are same, so the goal position is the same as the position before and after continuous operation. Therefore, the current position positioned by continuous operation is P2. (A area and B area both are same size)
- When continuous operation is executed on relative coordinates, the movement amount between current position and goal position is the real goal position. Therefore, the goal position is different from the one without continuous operation. The position positioned by continuous operation is P1 + P2.

(3) Restrictions

In the cases below, continuous operation is not executed and previous operation is being kept.

- (a) Acc./Dec. pattern of extended parameter is "S-curve operation". (error code : 390)
- (b) It is in dwell. (error code : 392)
- (c) The current control is not shortcut position control or linear interpolation. (error code : 393)
- (d) Speed data value of operation step to be executed next is 0 or exceeds the speed limit. (error code : 394)
- (e) Execute continuous operation command on sub axis. (error code : 395)

User has to execute continuous operation command on main axis in linear interpolation.

- (f) Execute continuous operation command on axis in circular interpolation. (error code : 396)
- (g) Execute continuous operation on sub axis in sync. operation. (error code : 397)
- (h) The current operation step no. is the last step(400) of operation data. (error code : 399)
- (i) The current axis in operation is executed by direct start command. (error code : 400)

[Example] Execute continuous operation on axis1 operating by absolute, shortcut position control

- Current position of Axis1 : 0
- Setting example in XG-PM
 - Operation data of axis1

Step no.	Control method	Operation	Goal position [pls]	Operation speed [pls/s]	Acc. no.	Dec. no.	M code	Dwell time
1	Absolute, shortcut position control	Singular, end	1000	1000	No.1	No.1	0	0
2	Absolute, shortcut position control	Singular, end	5000	2000	No.1	No.1	0	0

■ Operation pattern

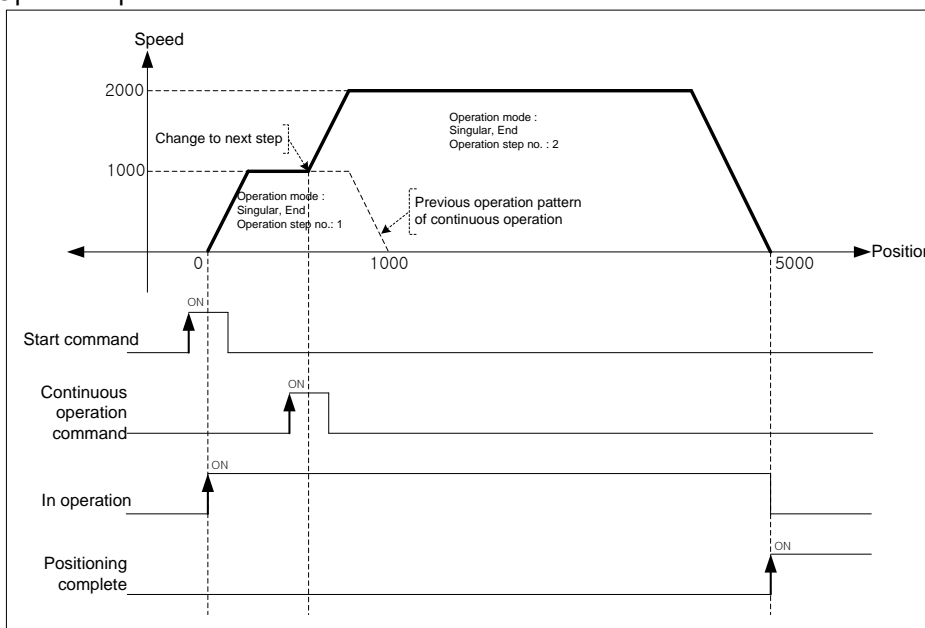

9.5.3 Skip Operation

Decelerate and stop the current operation step and change to the operation data of next operation step no., then execute positioning control.

(1) Characteristics of Control

- (a) SKIP operation command stops the operation and carries out the operation of next step after executing the command other than Continuous operation command (Next Move).
- (b) This is used in case that the operation mode is End, Go-on, Continuous and the operation pattern is in Acceleration, Constant speed, Deceleration section.
- (c) If SKIP operation command is executed in the status that the operation data of next step is not yet set, Error 151 will occur.
- (d) When set position data, there would be differences on skip operation command depending on absolute coordinates and relative coordinates,

(2) Operation timing

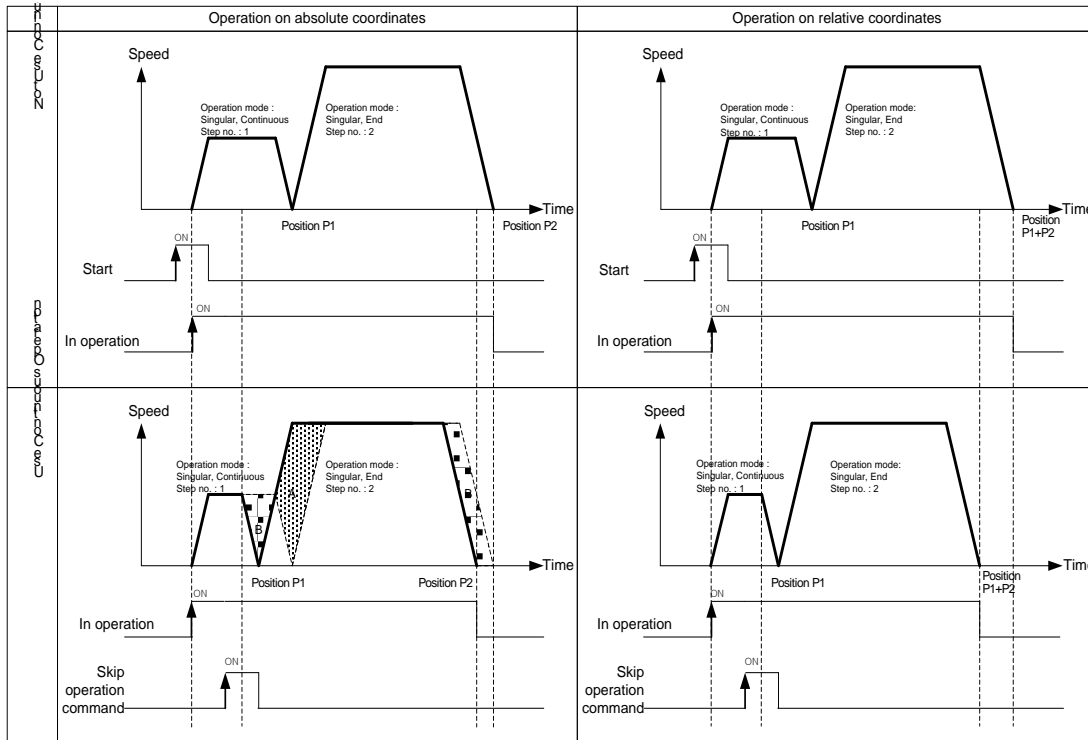

- The goal position of next operation step after skip operation command is executed on absolute coordinates is the same as the case did not execute skip operation. Therefore, current position positioned by skip operation is P2. (A area and B area both are same size)
- When skip operation is executed on relative coordinates, the movement amount between current position and goal position is the real goal position. Therefore, the goal position is different from the one without continuous operation. The position positioned by skip operation is P1 + P2.

(3) Restrictions

In the cases below, skip operation is not executed and previous operation is being kept.

- (a) Execute skip operation command on the sub axis of linear interpolation. (error code:332)
Skip operation in linear interpolation operation must be executed on main axis.
- (b) Execute skip operation command on the sub axis of sync. operation. (error code:333)
- (c) Execute skip operation command on the axis in Jog operation. (error code:335)
- (d) The current axis is executed by direct start. (error code:336)
- (e) Execute skip operation on the axis in Inching operation. (error code:337)
- (f) Execute skip operation on the sub axis of circular interpolation. (error code:338)
Skip operation in circular interpolation operation must be executed on main axis.

[Example] Execute skip operation command on axis1 operating by absolute and shortcut position control.

- Current position of axis1 : 0
- Setting example in XG-PM
- Operation data of axis1

Step no.	Control method	Operation method	Goal position [pls]	Operating speed [pls/s]	Acc.no.	Dec.no.	M code	Dwell time
1	Absolute, single-axis position control	Singular,End	1000	1000	No.1	No.1	0	0
2	Absolute, Single-axis position control	Singular,End	5000	2000	No.1	No.1	0	0

■ Operation pattern

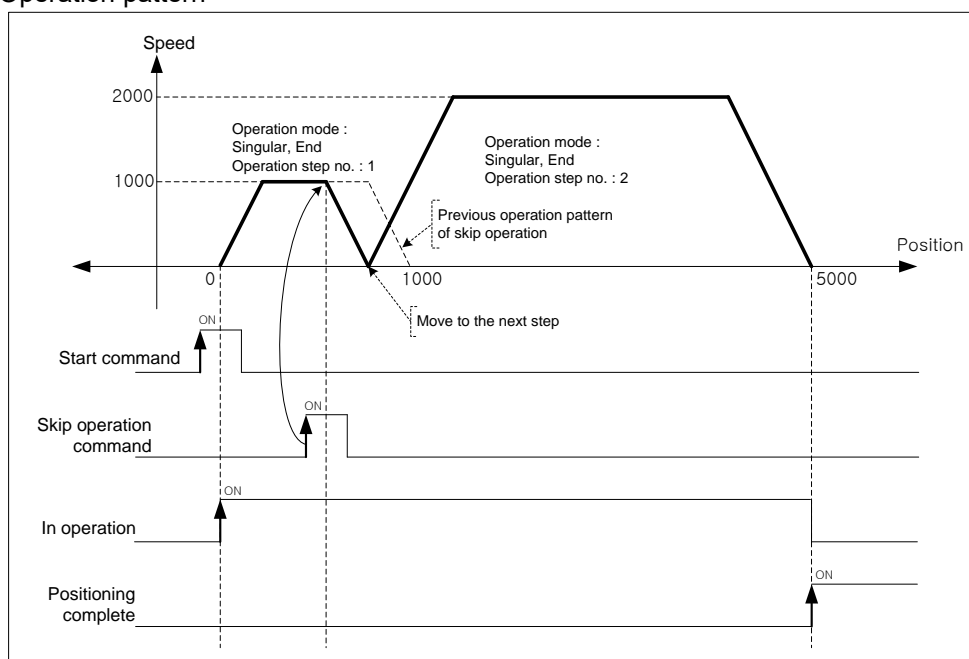

9.5.4 Position Override

This is used to change the goal position during positioning operation by positioning data.

(1) Characteristics of Control

(a) Position override command is used in the operation pattern (Acceleration, Constant speed, Deceleration section) and the available operation mode is End operation, Go-on operation, Continuous operation.

(b) Position setting range is $-2147483648 \sim 2147483647$ Pulse.

(c) As the operation is different according to Position Override command during operation, cares should be taken in using.

In other words, if position of position override at the moment of commanding position override is bigger than the position it stopped at, the positioning direction would be forward. If it is smaller, the direction would be reverse.

(d) This command may be executed several times in operation.

(2) Operation timing

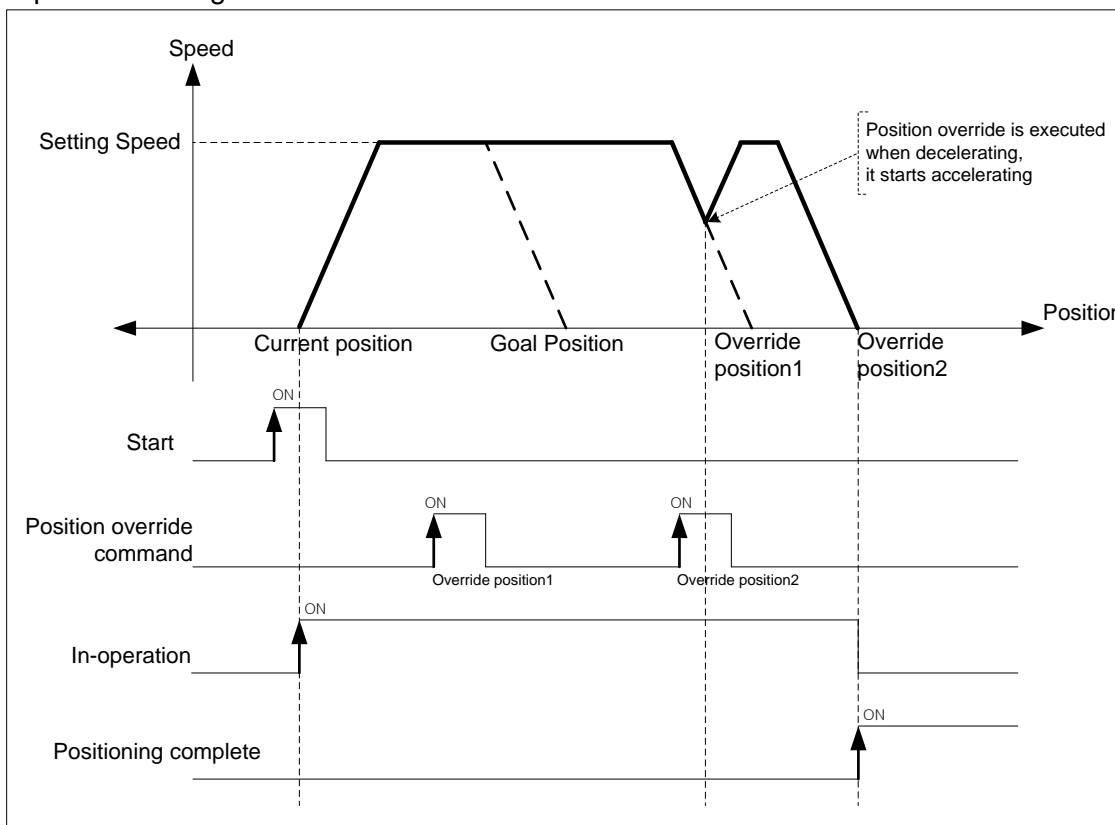

If position override is executed in operation, the goal position is changed to override position1 and keep operating. If position override for override position2 is executed at dec. area, positioning is finished by acc. speed already set at override position2.

- The case that override position is smaller than decelerating stop position.

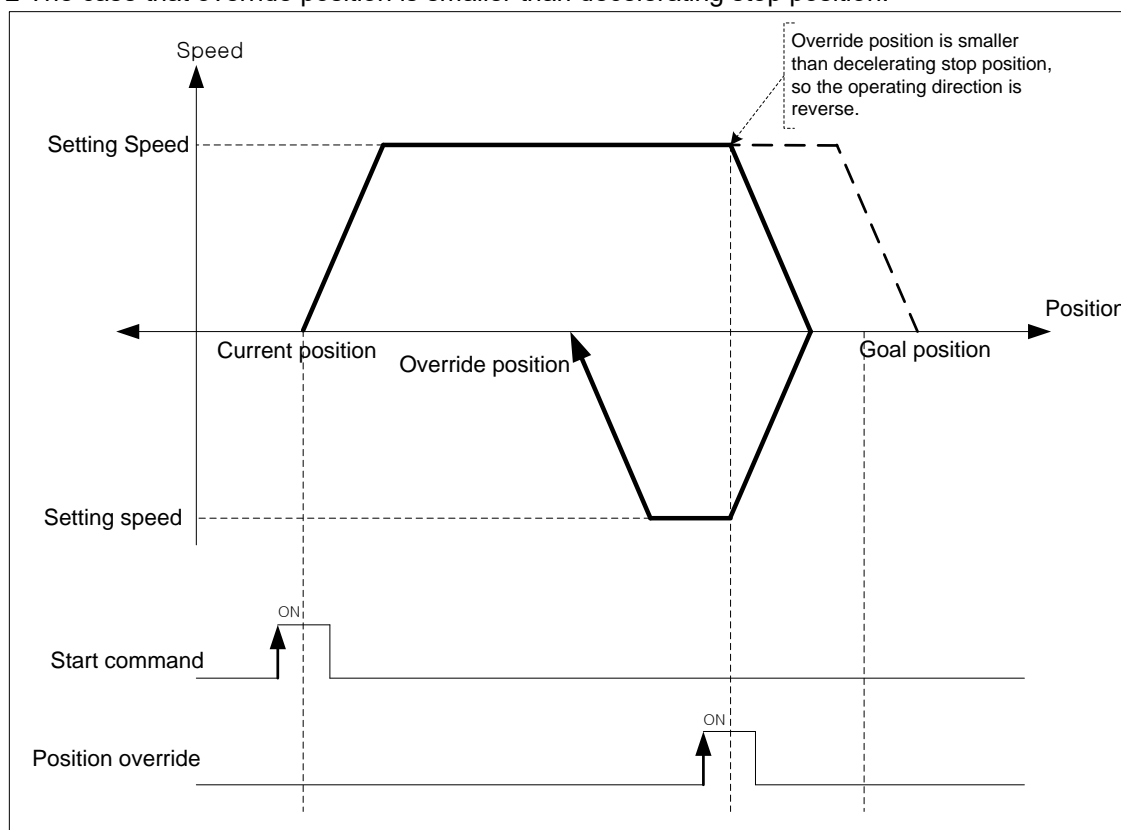

(3) Restrictions

In the cases below, position override is not executed and previous operation is being kept.

- Execute position override in dwell. (error code:362)
- Current operation is not positioning control(shortcut positioning, Inching operation). (error code:363)
- Execute position override on the axis operating linear interpolation. (error code:364)
- Execute position override on the axis operating circular interpolation. (error code:365)
- Execute position override on the sub axis of sync. operation. (error code:366)

[Example] Execute position override on axis1 operating by absolute, shortcut position control.

■ Current position of axis1 : 0

■ Setting example in XG-PM

▫ Operation data of axis1

Step no.	Control method	Operation method	Goal position [pls]	Operation speed [pls/s]	Acc.no.	Dec.no.	M code	Dwell time
1	Absolute single axis position control	Singular, End	1000	1000	No.1	No.1	0	0
2	Absolute single axis position control	Singular, End	5000	2000	No.1	No.1	0	0

■ Operation pattern

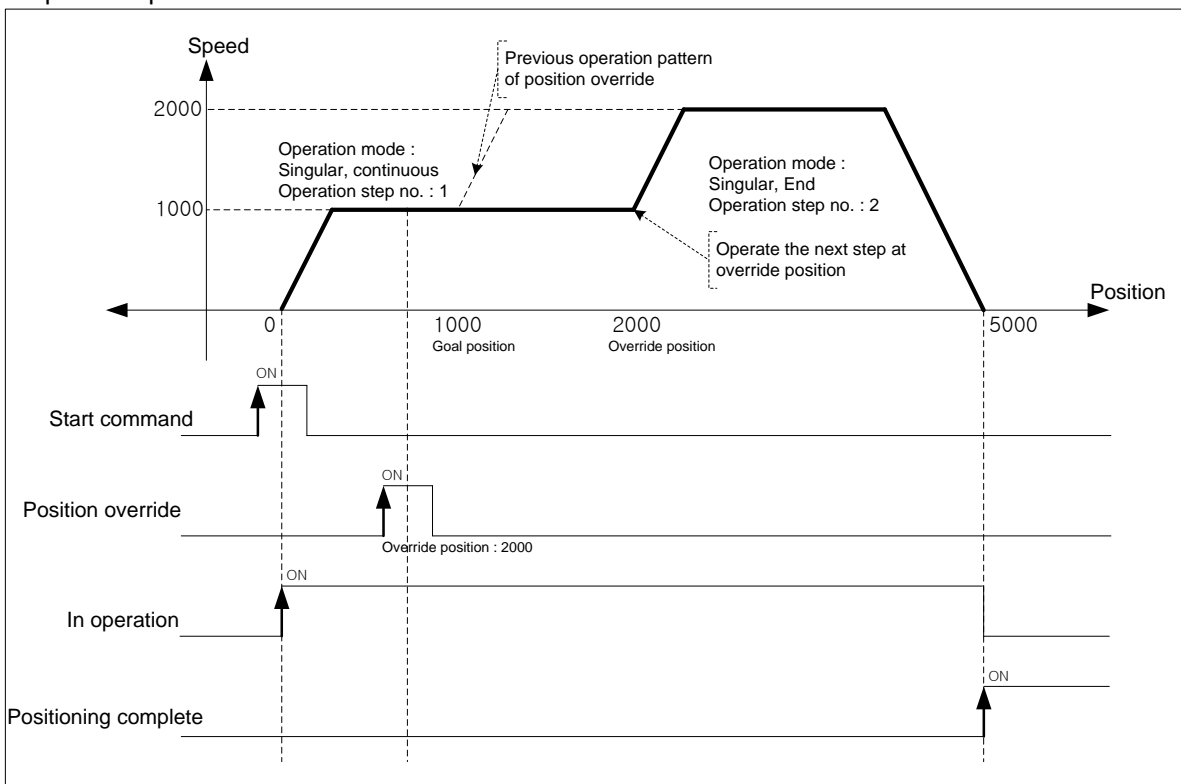

Remark

If operation pattern is “continuous” and override position is bigger than goal position, keep operating at current speed then continue to operate the next step. If override position is smaller than goal position, execute decelerating stop and position in reverse direction, then continue to operate the next step.

9.5.5 Speed Override

When user wants to change the operation speed of positioning control, user may change the speed with speed override command.

(1) Characteristics of Control

- Speed override command is available in acc./steady speed area and available operation modes are “end”, “go on” and “continuous”.
- It may be executed several times in operation.
- User may set speed override value as “%setting” or “speed setting” on [Speed override] of common parameter.
- Related parameter setting (common parameter)

Items	Setting value	Description
Speed override	0 : %setting	Set the speed override setting value by %
	1 : speed setting	Set the speed override setting value with exact number

(e) Auxiliary data of speed override command setting

Items	Setting value	Description
Speed	1 ~ 65535 (1=0.01%)	Set the speed override setting value with percentage (If it is 100%, set 10000)
	1 ~ Speed limit	Set the speed override setting value directly

(2) Operation timing

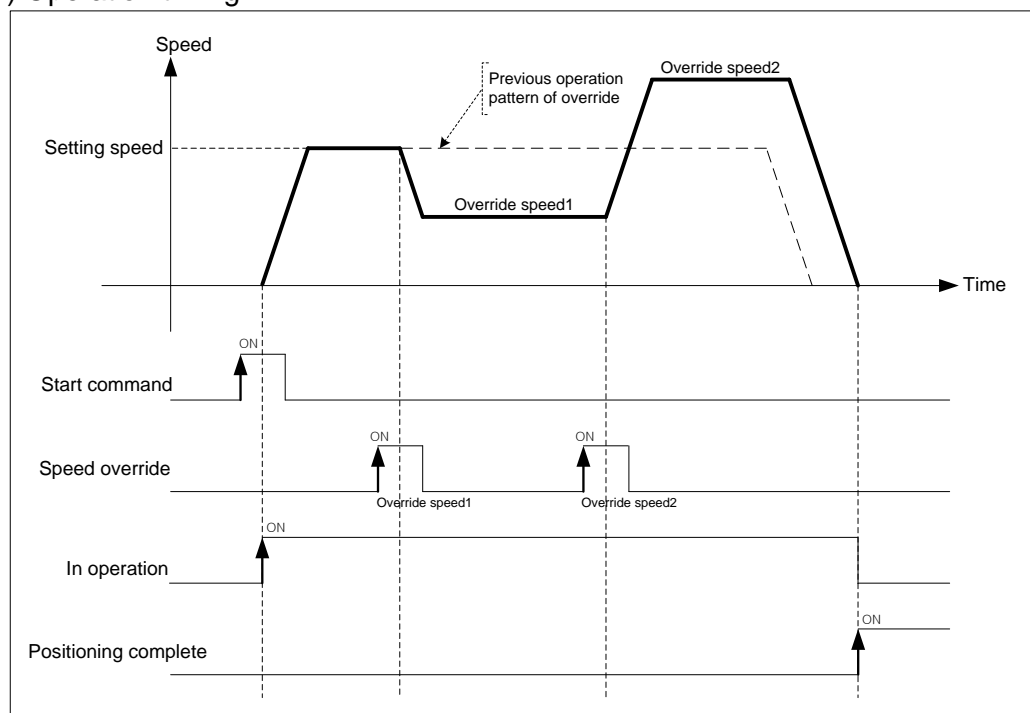

(3) Restrictions

In the cases below, speed override is not executed and previous operation is being kept.

- (a) Value of speed override exceeds speed limit of basic parameter. (error code:372)
Speed value of Speed override must be below speed limit.
Override speed of linear interpolation for each axis need to be below speed limit.
- (b) Execute speed override on the sub axis of linear interpolation. (error code:373)
In linear interpolation, speed override must be executed on main axis.
- (c) Execute speed override on the sub axis of circular interpolation. (error code:374)
In circular interpolation, speed override must be executed on main axis.'
- (d) Execute speed override on sub axis of sync. operation. (error code:375)
- (e) Execute speed override in dec. area. (error code:377)
- (f) In the case that acc./dec. pattern of extended parameter is "S-curve operation". (error code:378)

[Example] Execute speed override(50%→100%→200%→150%) on axis1 operating by absolute, shortcut position control.

- Current position of axis1 : 0
"Speed override" of common parameter : Set %
"Speed limit" of basic parameter : 3000 [pls/s]

■ Setting example of XG-PM

▪ Operation data of axis1

Step no.	Control method	Operation method	Goal position [pls]	Operation speed [pls/s]	Acc.no.	Dec.no.	M code	Dwell time
1	Absolute, single-axis position control	Singular, End	1000	2000	No.1	No.1	0	0

■ Operation pattern

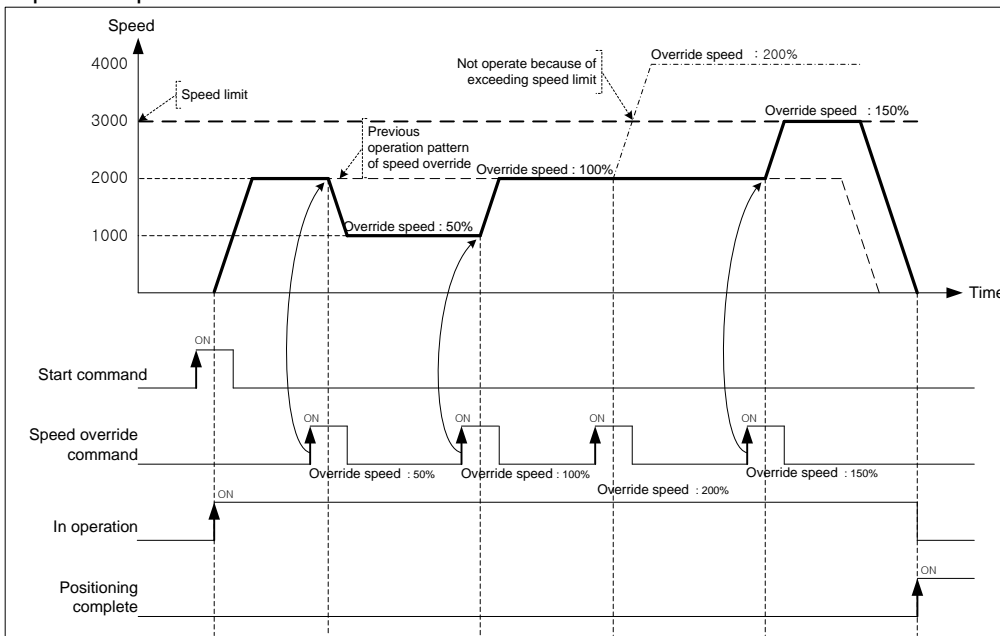

9.5.6 Positioning Speed Override

This is the command to operate by the changed operation speed if it reaches the setting position during positioning operation.

(1) Characteristics of Control

- (a) This command is used only in Acceleration and Constant speed section from operation pattern and the available operation mode is End, Go-on, Continuous operation.
- (b) As this command is not carried out in Deceleration section, cares should be taken in using.
- (c) The position setting range is $-2147483648 \sim 2147483647$ Pulse.
- (d) User may set speed override value as “%setting” or “speed setting” on [Speed override] of common parameter.
- (e) User may select that consider the designated position value on “coordinates of positioning speed override” of extended parameter as an absolute position or a relative position.
- (f) Related parameter setting

■ Common parameter

Items	Setting value	Description
Speed override	0 : Set %	Set the value of speed override by %
	1 : Set speed	Set the value of speed override with exact number

■ Extended parameter

Items	Setting value	Description
Coordinates of positioning speed override	0 : Absolute	Speed override is executed in the designated absolute position
	1 : Incremental	Start speed override from the position increment added

(g) Auxiliary data setting of positioning speed override command

Items	Setting value	Description
Position	$-2147483648 \sim 2147483647$	Set the position to start speed override
Speed	1 ~ 65535 (1=0.01%)	If speed override is “%”, set the speed by % (100% is 10000)
	1 ~ Speed limit	If speed override is “Exact number”, set the speed with exact number

Remark

While the current position is not exactly same as the value set on speed override, if the position of speed override is at between previous scan and current scan, speed override is executed at the speed set.

(2) Operation timing

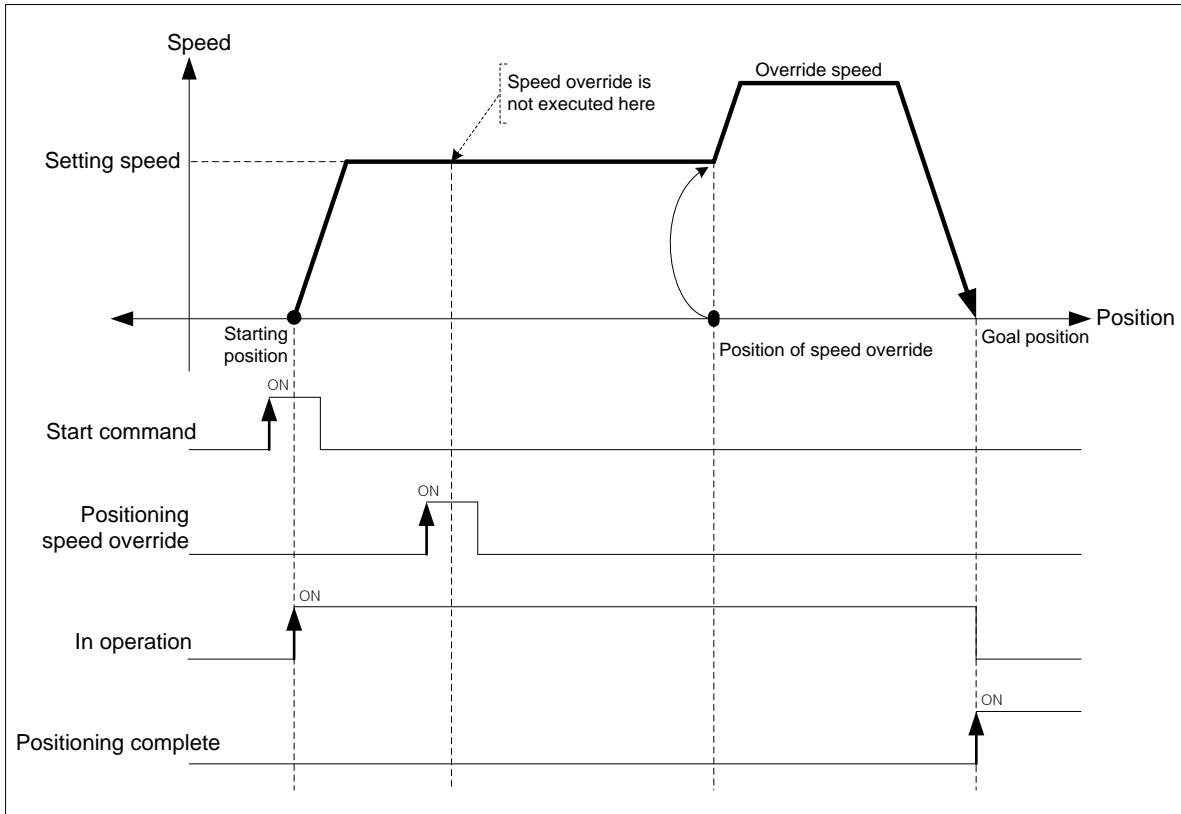

(3) Restrictions

In the cases below, positioning speed override is not executed and previous operation is being kept.

- (a) Current operation is not positioning (shortcut position control, Inching operation) control. (error code:382)
- (b) The value of speed override exceeds speed limit of basic parameter. (error code:383)
The speed value of speed override must be below speed limit.
Override speed of linear interpolation for each axis need to be below speed limit.
- (c) Execute positioning speed override on the sub axis of linear interpolation. (error code:384)
In linear interpolation, positioning speed override must be executed on main axis.
- (d) Execute speed override on the sub axis of circular interpolation. (error code:385)
In circular interpolation, positioning speed override must be executed on main axis.'
- (e) Execute speed override on sub axis of sync. operation. (error code:386)
- (f) In the case that acc./dec. pattern of extended parameter is "S-curve operation". (error code:389)
- (g) If execute positioning speed override in dec. area., although error does not arise but speed override is not executed. However, execute positioning speed override command in non-dec. area and speed override is executed when it is decelerating, error arises. (error code:377)

[Example] Execute positioning speed override at 4000 [pls/s] at 2000(position of speed override) on axis1 operating by absolute, shortcut position control.

- Current position of axis1 : 0
 - 「Speed override」 of common parameter : Speed setting
 - 「Speed limit」 of basic parameter : 5000 [pls/s]
 - 「Coordinates of positioning speed override」 of extended parameter : Absolute

■ Setting example in XG-PM

▫ Operation data of axis1

Step no.	Control method	Operation method	Goal position [pls]	Operation speed [pls/s]	Acc.no.	Dec.no.	M code	Dwell time
1	Absolute single axis position control	Singular, End	5000	2000	No.1	No.1	0	0

■ Operation pattern

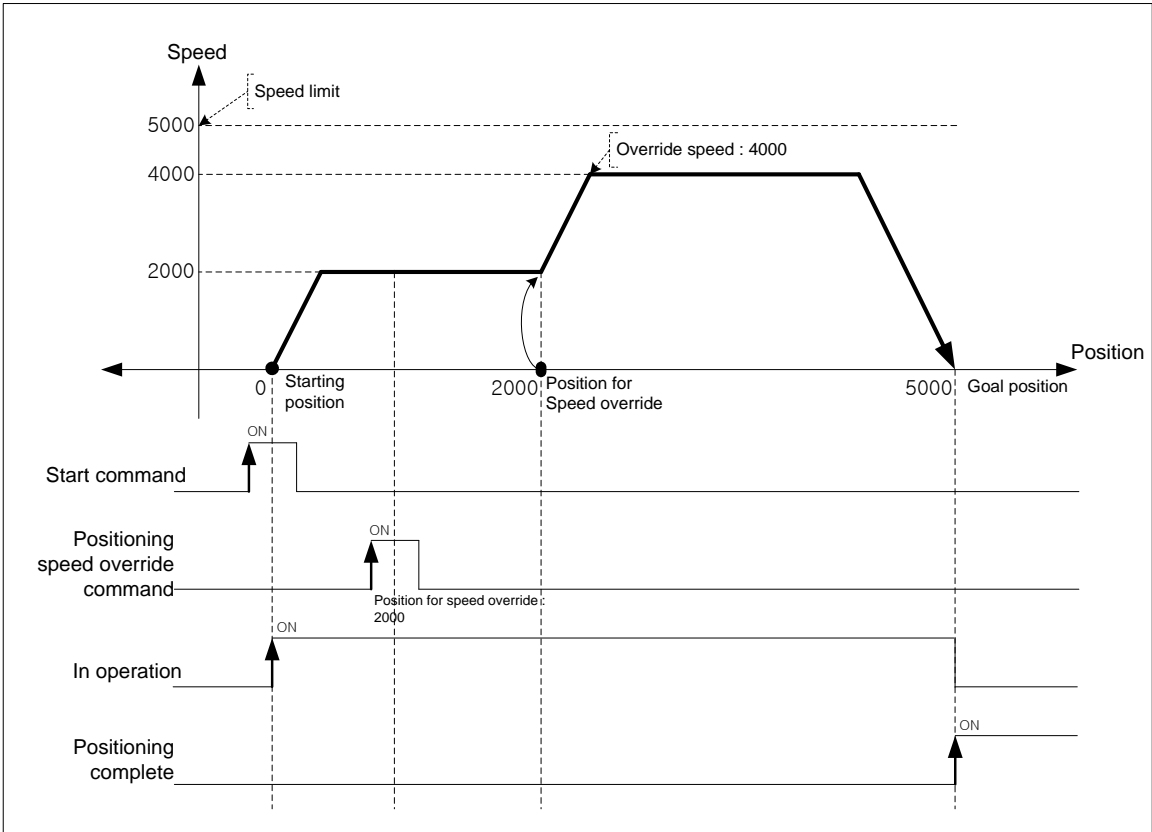

9.5.7 Current Position Preset

This command is for changing the current position value to the value at user's pleases.

(1) Characteristics of Control

- (a) If user uses this command, the origin-undecided status becomes origin-decided status.
- (b) When the current position is changed by position changing command, the mechanical origin position is changed. If user wants to use the mechanical origin again, has to execute homing command.
- (c) The current position preset command may not be executed in operation.
- (d) Auxiliary data setting of current position preset command.

Items	Setting value	Description
Position	-2147483648 ~ 2147483647	Set the position to change

(2) Operation timing

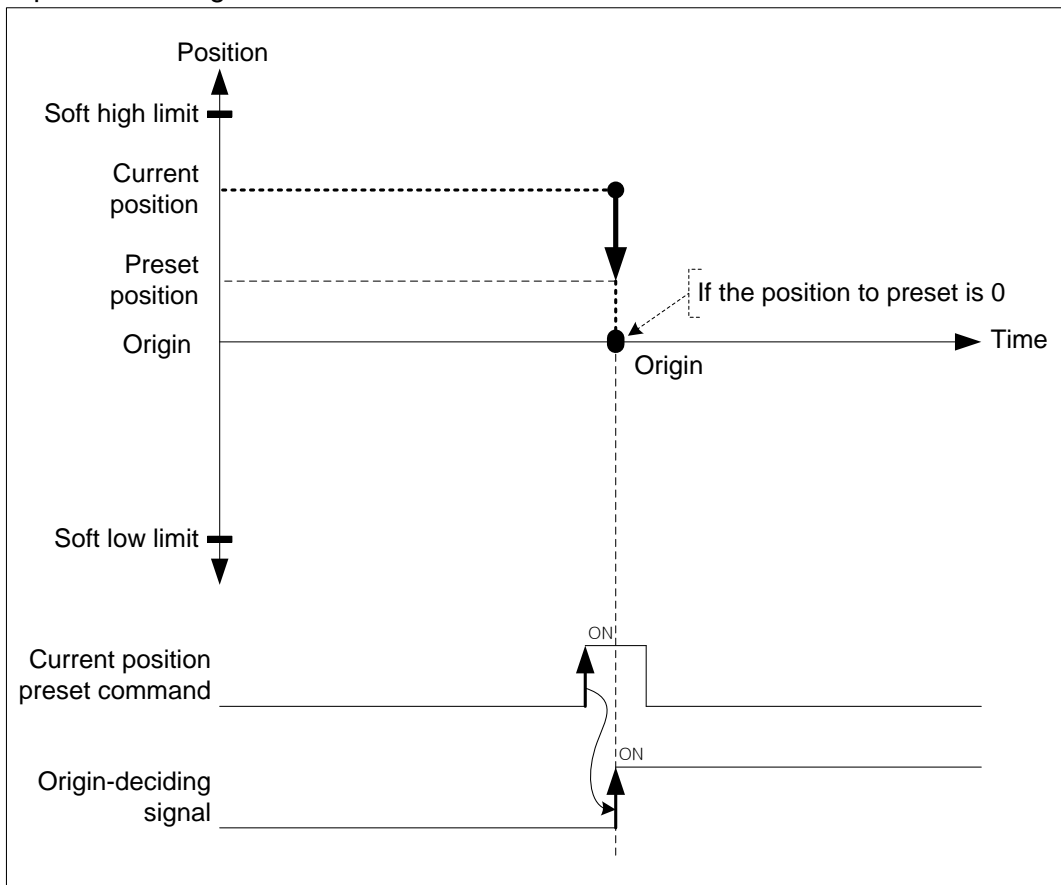

(3) Restrictions

In the cases below, current position preset is not executed and error arises.

- (a) Setting value of current position preset exceeds soft high/low limit of extended parameter. (error code:452)

9.5.8 Encoder Preset

This command is for changing the value of current encoder position to the value at user's pleases.

(1) Characteristics of Control

- (a) User may change the current position value.
- (b) If there is an encoder being main axis, the speed of sub axis is possible to be changed dramatically, so encoder preset command may not be executed.
- (c) Encoder preset command should be executed in the status that external encoder pulse input is not entered.
- (d) Auxiliary data setting of encoder preset command

Items	Setting value	Description
Position	-2147483648 ~ 2147483647	Set the encoder position to change on selected encoder
Types	0 : Encoder1	Select encoder to change

(2) Operation timing

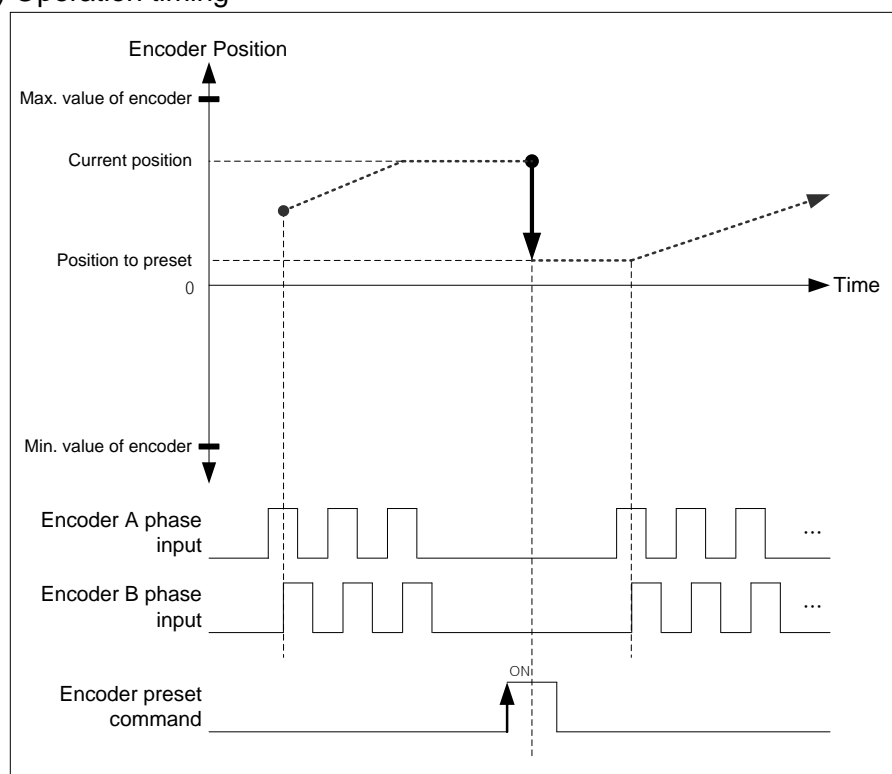

(3) Restrictions

In the cases below, encoder preset command may not be executed and error arises.

- (a) There is an encoder 1 operating as a main axis (error code: 532)
- (b) Position value of encoder1 preset exceeds the max./min. value of encoder1 of common parameter. (error code:534)

9.5.9 Start Step no. Change

This command is for changing the current step no. when executing indirect start command.

(1) Characteristics of Control

- (a) When starting with setting step no. as 0 in indirect start command, current operation step no. is executed.
The current step no. may be changed by start step no. change command.
- (b) This command may be only executed in stop motion or error arises.
- (c) Auxiliary data setting of start step no. change command.

Items	Setting value	Description
Step	1 ~ 400	Set the step no. to change

(2) Operation timing

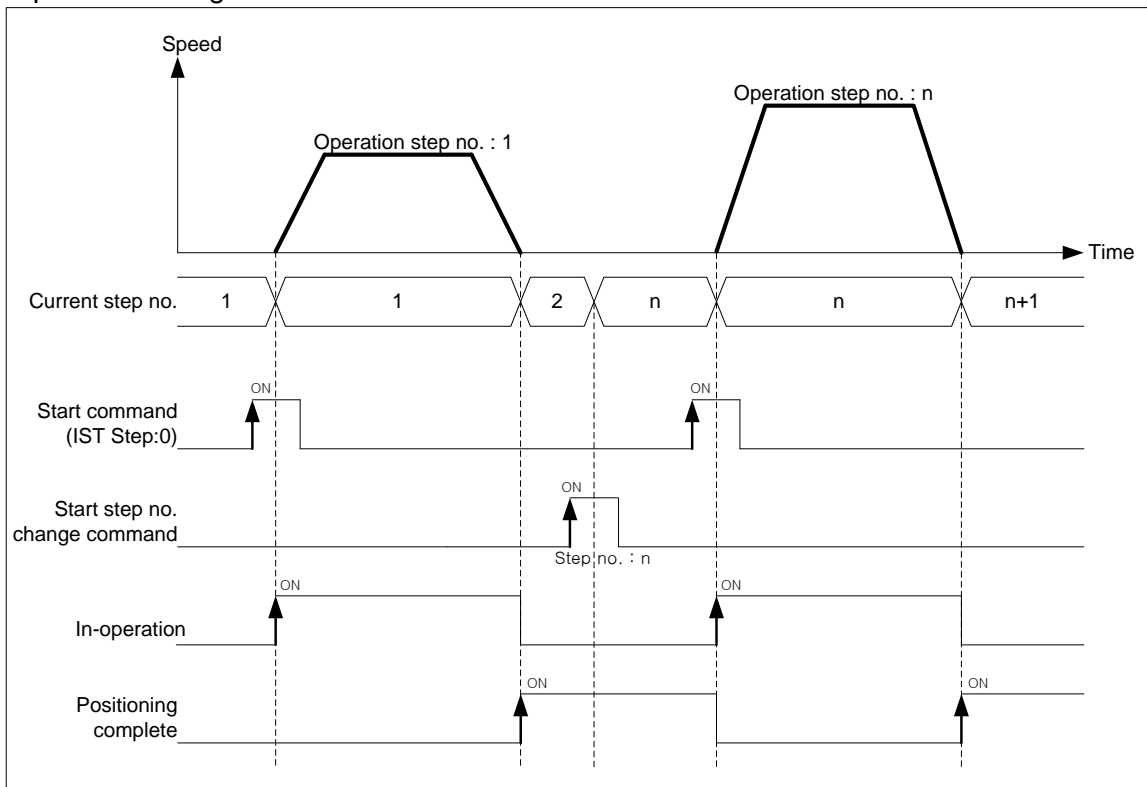

(3) Restrictions

In the case below, start step no. change command is not executed.

- (a) Step no. to change is out of 0 ~ 400. (error code:442)
If step no. is 0, keep the current step no.

9.5.10 Repeat Operation Step no. Change

This command is for changing the repeat operation step no will be executed next.

(1) Characteristics of Control

- In case of repeat operation mode setting (End, Go-on, Continuous operation), the current operation step no. will be changed automatically to operate the step no.1 when repeat operation mode setting step completes the positioning operation but if start step no. change command is executed in repeat operation, the step no. will be changed with the assigned step no. not the step no.1 .
- The repeat operation step no. change command can be executed during positioning operation.
- Auxiliary data setting of repeat operation step no. change command

Items	Setting value	Description
Step	1 ~ 400	Set the repeat operation step no. to change

(2) Operation timing

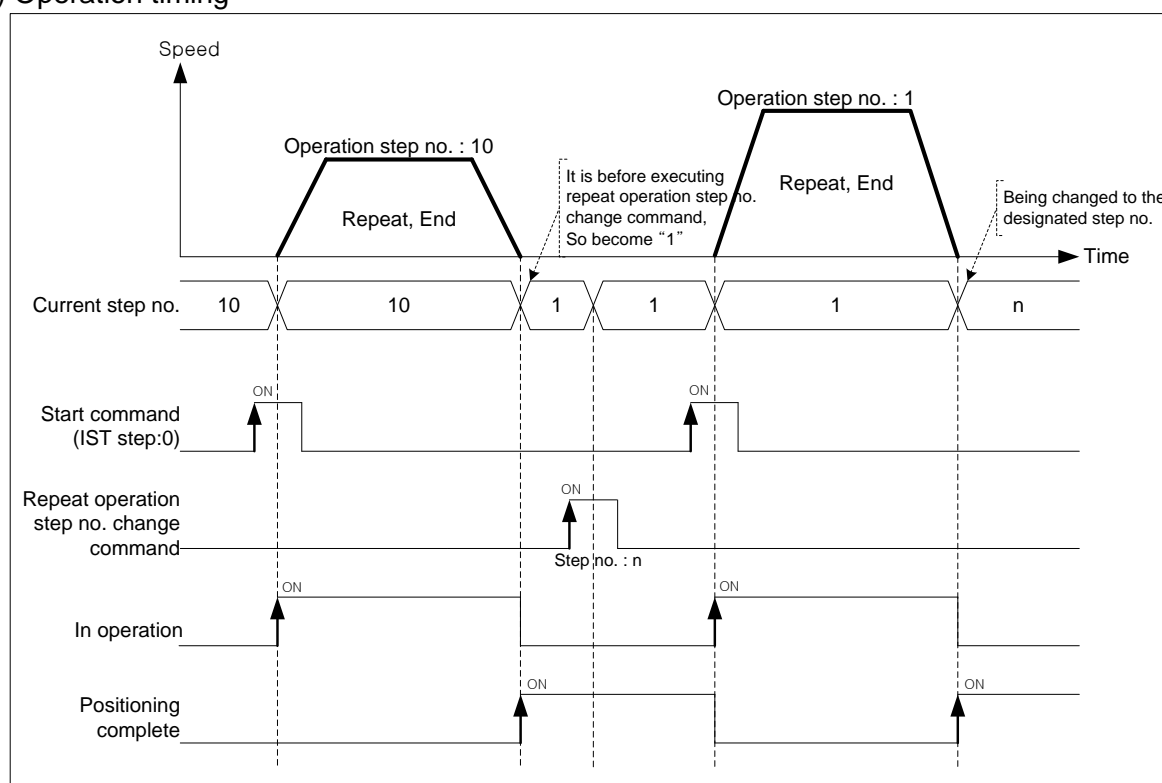

Remark

The current operation step is not changed at the moment of executing the command. After "Repeat" positioning data operation is finished, it is changed to the step designated by repeat operation step no. change command.

(3) Restrictions

In the case below, repeat operation step no. change command is not executed.

(a) Step no. to change is out of 0 ~ 400. (error code:442)

If the step no. is 0, keep the previous step no.

[Example] Execute repeat operation step no. change command on axis1 operating by absolute, shortcut position control.

- Current position of axis1 : 0
- Setting example in XG-PM

■ Operation data of axis1

Step no.	Control method	Operation method	Goal position [pls]	Operation speed [pls/s]	Acc. no.	Dec. no.	M code	Dwell time
1	Absolute single axis position control	Singular, Go on	1000	1000	No.1	No.1	0	0
2	Absolute single axis position control	Singular, continuous	2000	2000	No.1	No.1	0	0
3	Absolute single axis position control	Singular, continuous	4000	3000	No.1	No.1	0	0
4	Absolute single axis position control	Repeat, Continuous	2000	3000	No.1	No.1	0	0
5	Absolute single axis position control	Singular, End.	5000	2000	No.1	No.1	0	0

■ Operation pattern

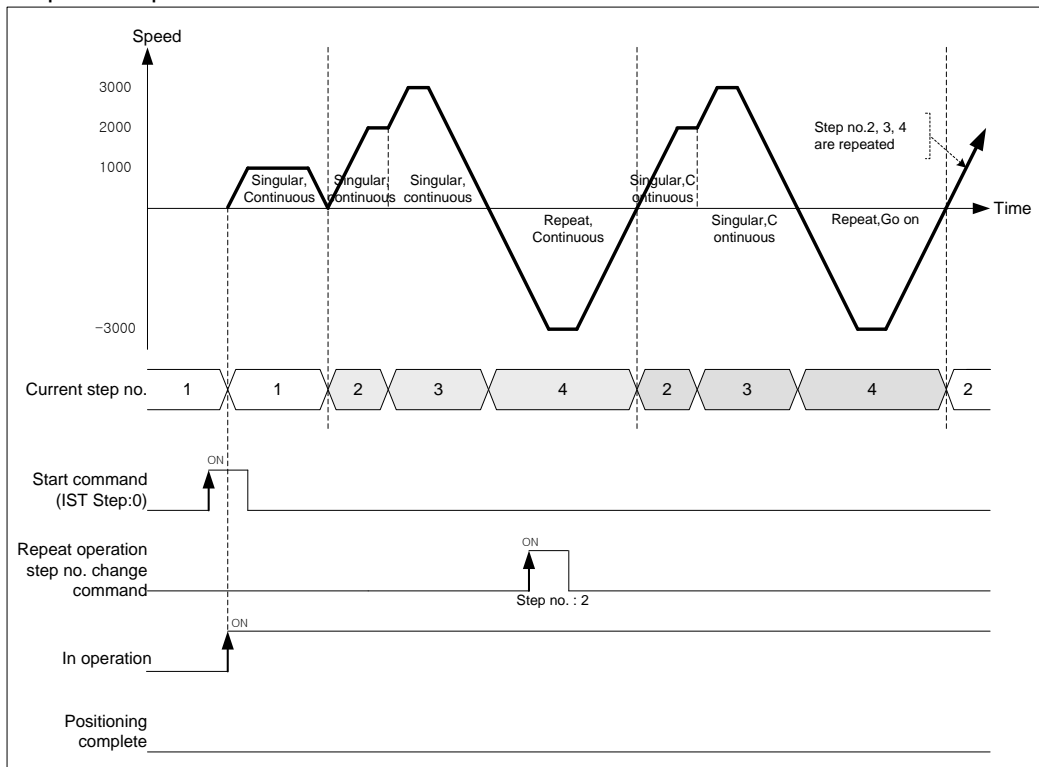

9.5.11 Infinite Running Repeat Function

Infinite Running Repeat Function means the function refreshing the command position and current position value automatically and periodically with the value specified “Infinite Running Repeat Position” at extended parameter. If you use this function, positioning with repeated position value for the same direction is available.

(1) Characteristics of Control

- (a) If you set “Infinite Running Repeat” of the Extended parameter as “1: Enable”, you can use “Infinite Running Repeat” function.
- (b) Set the position value to be refreshed automatically at “Infinite Running Repeat position” of the extended parameter.
- (c) When “Infinite Running Repeat” parameter is “1: Enable”, command position and current position value are expressed as 0 ~ “Infinite Running Repeat - 1”

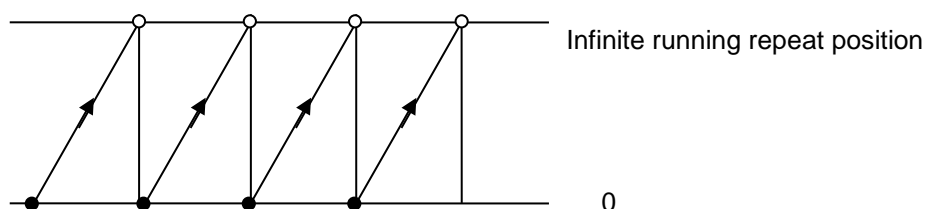

- (d) When setting “Infinite Running Repeat” parameter as “1: Enable”, if current position is out of the range of Infinite Running Repeat, it will be changed into the value within the range of Infinite Running Repeat automatically.

[Ex1] In case current position is 32100, infinite running repeat position is 10000,
When setting “Infinite Running Repeat” parameter as “1: Enable”, current position will be 2100.

[Ex2] In case current position is -32100, infinite running repeat position is 10000,
When setting “Infinite Running Repeat” parameter as “1: Enable”, current position will be 7900.

(e) Setting the extended parameter related with infinite running repeat function

Item	Setting value	Description	
Infinite running repeat position	pulse	1 ~ 2147483647[pulse]	Sets the repeated position value to be refreshed automatically.
	mm	1 ~ 2147483647[X10 ⁻⁴ mm]	
	Inch	1 ~ 2147483647[X10 ⁻⁵ Inch]	
	degree	1 ~ 2147483647[X10 ⁻⁵ degree]	
Infinite running repeat	0: Disable 1: Enable	Sets whether to enable Infinite running repeat function or not.	

(f) Shortest distance control

- 1) In case of absolute coordinate positioning, it automatically selects the rotation direction that makes the object reach the target position through shortest distance
- 2) Shortest distance control operates only when Control method of Direct Start Command (XDST, XPM_DST) is set as "3: Shortest Distance Control".
- 3) Restriction

In the following case, Shortest Distance Control can't be executed.

- a) When coordinate is set as incremental coordinate (Error code: 266).
 - b) When target position value is out of 0~Infinite Running Repeat Position (Error code: 227)
- (g) If Infinite Running Repeat function is enabled, you can't execute single-axis continuous operation and interpolation control.

(2) Operation Diagram

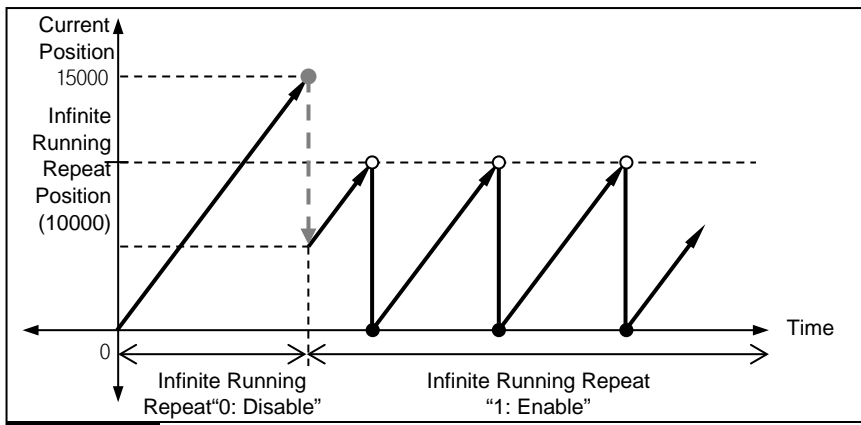

Remark

You can't change Infinite Running Repeat setting during operation. If you enable Infinite Running Repeat setting during stop state, in case current position is larger than Infinite Running Repeat position, current position will be changed to the value within Infinite Running Repeat position.

(3) Restriction

When Infinite Running Repeat function is set as "1: Enable", in the following case, error occurs.

- (a) When starting the operation step which is set as "Single-axis position control", "Continuous" (Error code: 239)
- (b) When starting the operation step which is set as "Linear interpolation" or "Circular interpolation" (Error code: 240)

(4) Operation Example

[EX1] It executes absolute, single-axis position control with the following settings while Infinite Running Repeat = 10000 pulse, Infinite Running Repeat "1: Enable"

- Start position : 2000 pulse, target position : 10000 pulse
- Setting example of XG-PM

Step No.	Control type	Operation type	Target position [pls]	Operation speed [pls/s]	Acc. No.	Dec. No.	M code	Dwell time
1	Absolute, single-axis position control	Single, End	10000	1000	No. 1	No. 1	0	100

■ Operation pattern

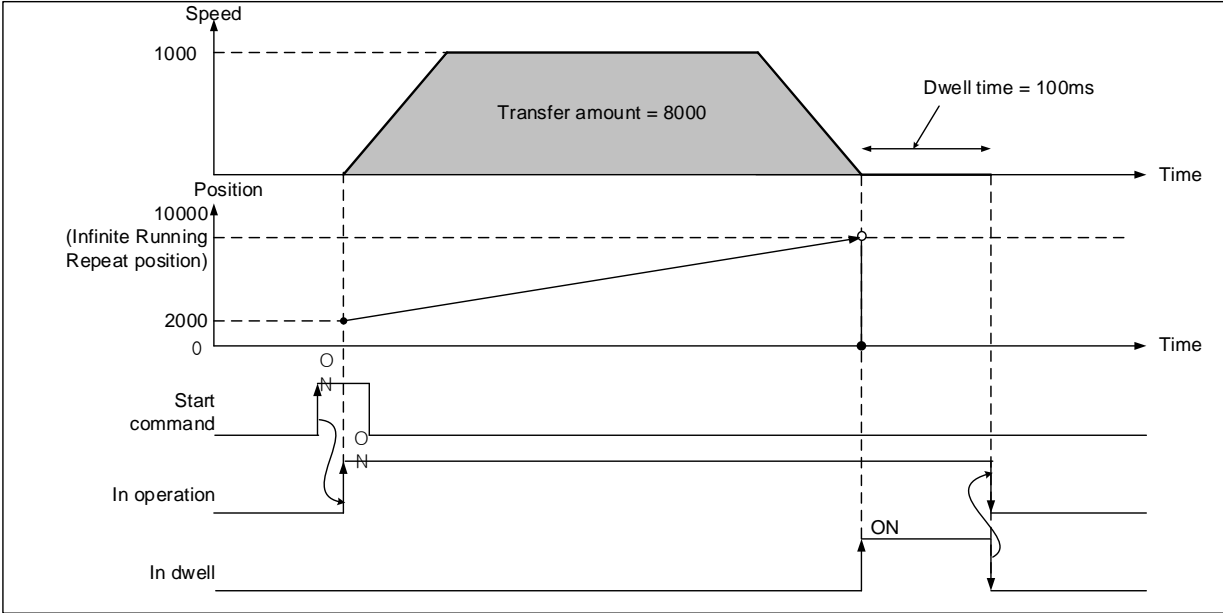

[EX2] It executes absolute, single-axis position control with the following settings while Infinite Running Repeat = 10000 pulse, Infinite Running Repeat "1: Enable"

- Start position : 2000 pulse, target position : -15000 pulse
- Setting example of XG-PM

Step No.	Control type	Operation type	Target position [pls]	Operation speed [pls/s]	Acc. No.	Dec. No.	M code	Dwell time
1	Absolute, single-axis position control	Single, End	-15000	1000	No. 1	No. 1	0	100

■ Operation pattern

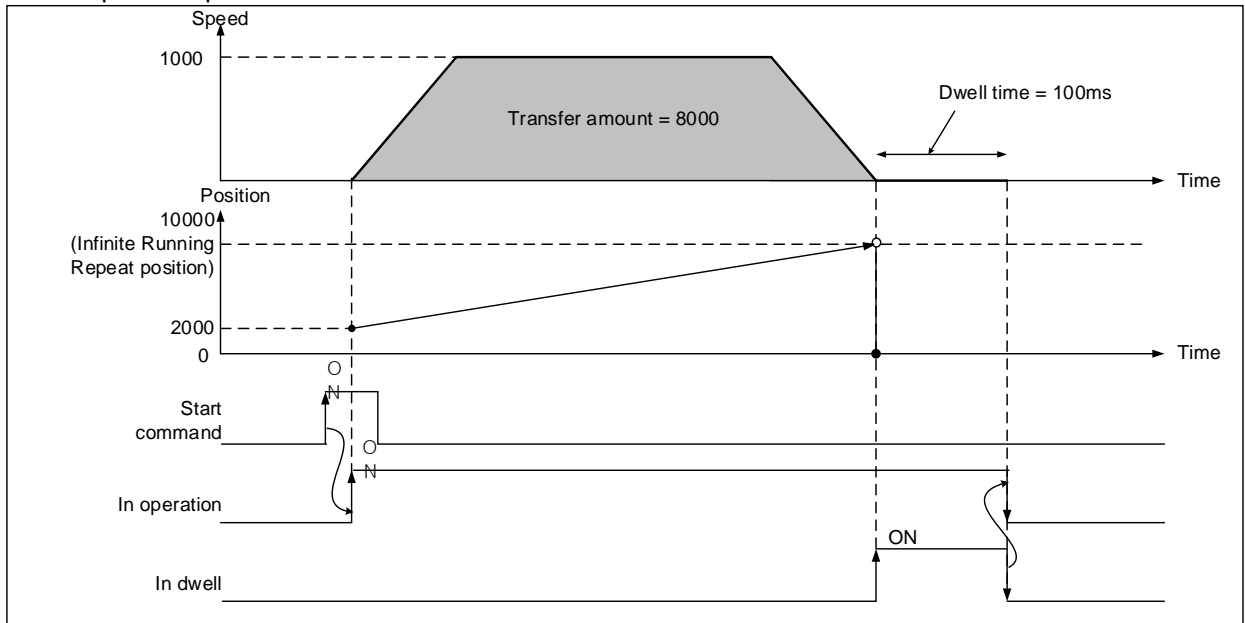

[EX3] It executes absolute, single-axis position control with the following settings while Infinite Running Repeat = 360.0 degree, Infinite Running Repeat "1: Enable"

■ Start position : 270.0°, target position : 45.0°, operation speed: 1000

1) Direct start control word setting = Absolute, shortest distance control

15 ~ 12	11 ~ 10	9 ~ 8	7 ~ 5	4	3 ~ 2	1 ~ 0
-	Dec. Time	Acc. Time	-	0: absolute coordinate	-	3: shortest distance control

■ Operation pattern

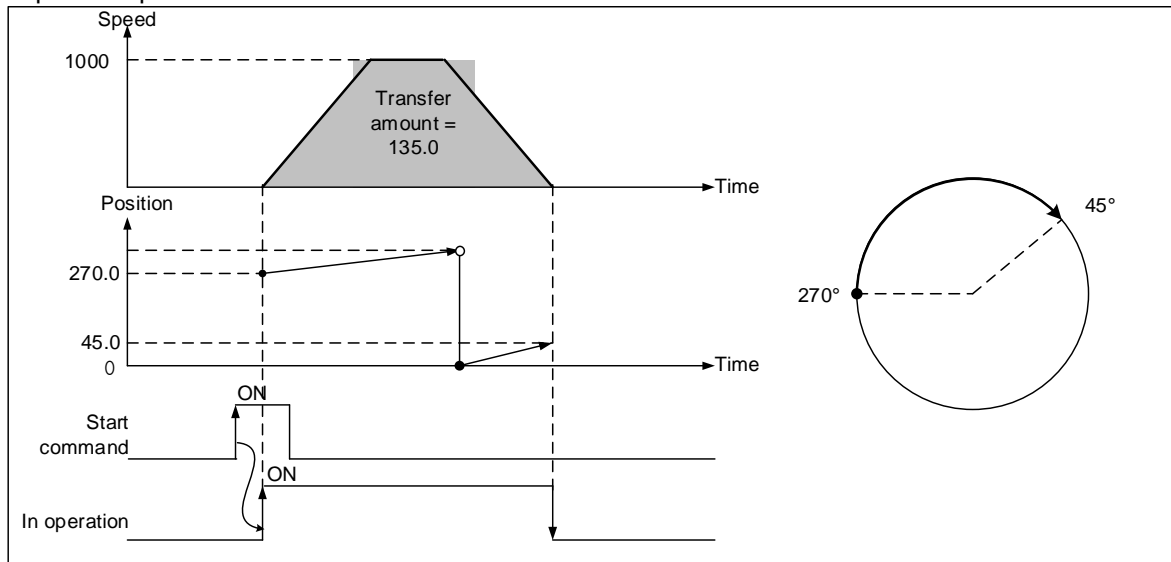

2) Direct start control word setting = Absolute, 0: Position control

15 ~ 12	11 ~ 10	9 ~ 8	7 ~ 5	4	3 ~ 2	1 ~ 0
-	Dec. Time	Acc. Time	-	0: absolute coordinate	-	0: Position control

■ Operation pattern

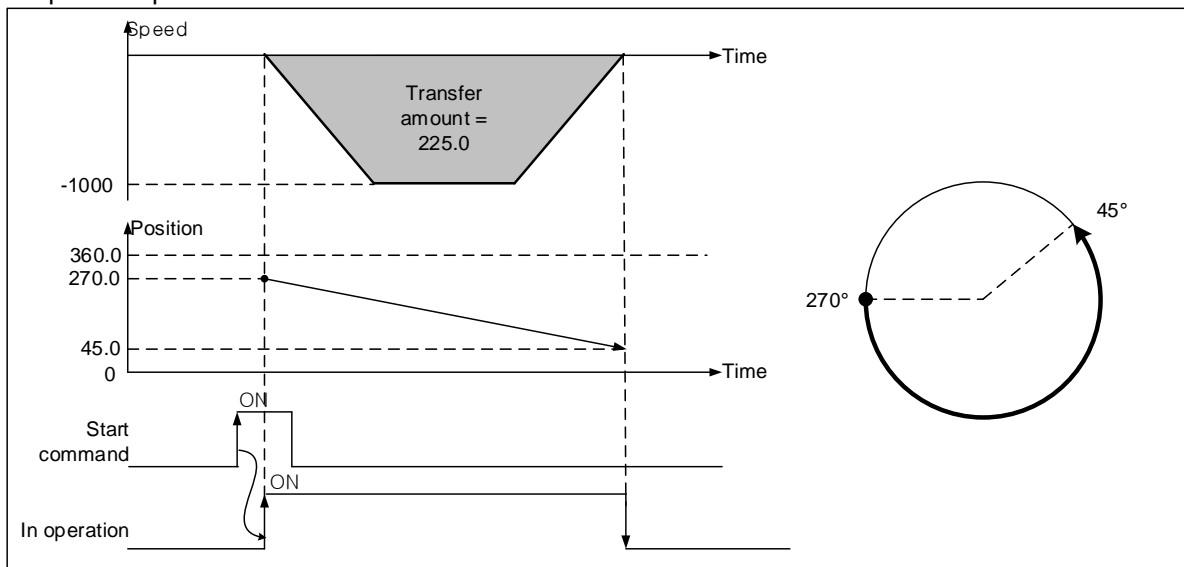

9.5.12 Speed, Acceleration/Deceleration Override

To change the operating speed or the acceleration/deceleration rate of the positioning control currently in operation, use the speed acceleration/deceleration override command. (XSETOVR/XPM_SETOVR)

(3) Control Characteristics

- (a) The speed acceleration/deceleration override command can be used only in accelerating sections or during constant speed sections of operation. Available operation commands are: End operation, continuous operation, and consecutive operation.
- (b) Multiple executions are possible during an operation.
- (c) You can set the speed override value as "designate %" or designate speed" in the speed override of the common parameter.
- (d) Setting Related Parameters (Common Parameter)

Category	Setting values	Description
Speed override	0: Designate %	Designates the setting value of speed override as a % of the set speed.
	1: Designate speed	Designates the setting value of speed override directly as the driving speed.

(e) Setting Secondary Data of the Speed Override Command

Category	Setting values	Description
Speed	1 – 65,535 (1= 0.01%)	If speed override is set as "Designate%", specify the percentage. (E.g. Set 10,000 for 100%)
	1 - speed limit value	If speed override is set as "Designate speed", specify the driving speed.

(4) Movement timing

(a) Command

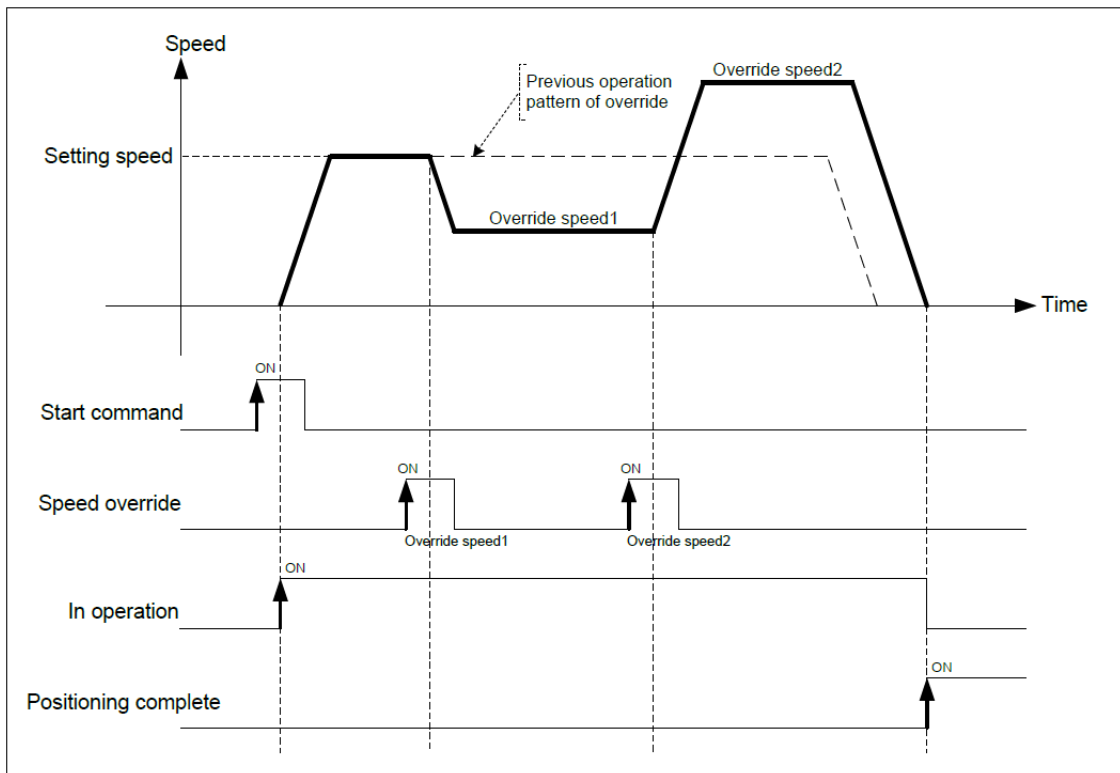

(b) Function block

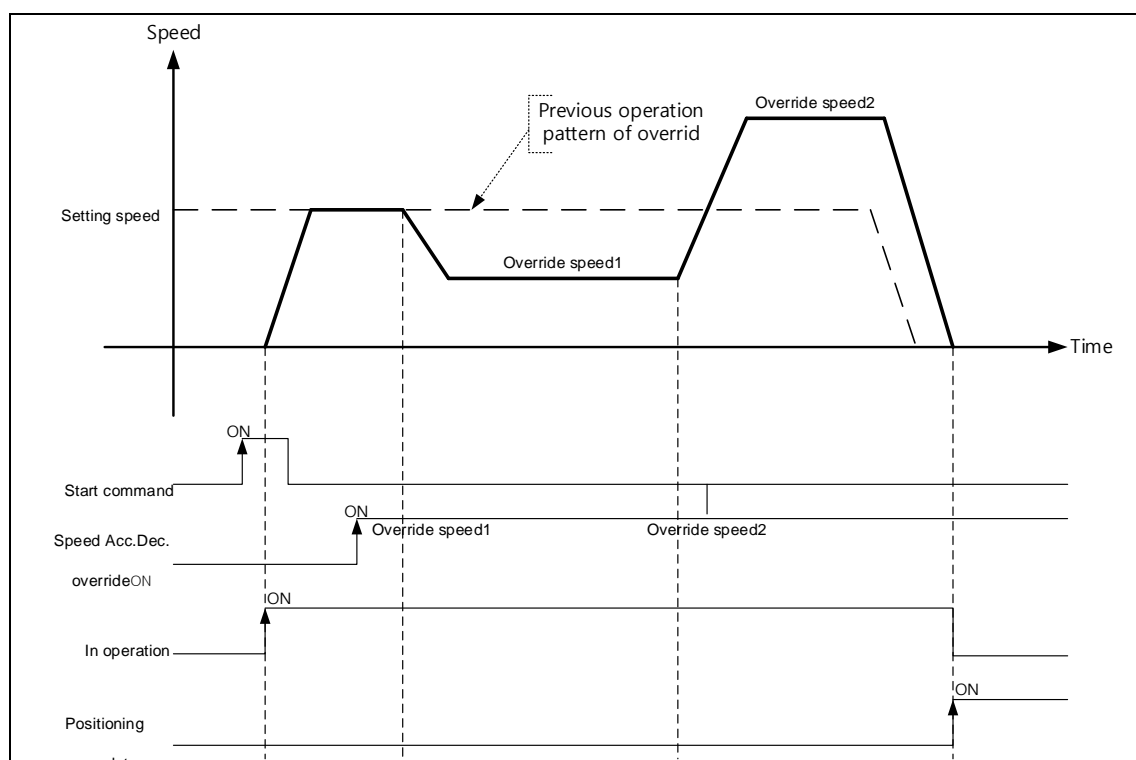

(4) Limitations

- (a) Speed override is not executed in the following cases, which are interpreted as errors, and the previous speed shall be maintained.
- (b) If the speed override value exceeds the speed limit value of the default parameter. (Error code: 372)
Set the speed value of the speed override as lower than the speed limit value.
If possible, set the speed override of the linear interpolation control as less than the speed limit for each interpolation axis.
- (c) If the speed override command is executed on the longitudinal axis of linear interpolation. (Error code: 373) If the linear interpolation is operating, the speed override command must be executed on the main axis.
- (d) If the speed override command is executed on the longitudinal axis of circular interpolation. (Error code: 374) If the circular interpolation is operating, the speed override command must be executed on the main axis.
- (e) If the speed override command is executed on the longitudinal axis of synchronized interpolation. (Error code: 375)
- (f) If the speed override command is executed in the deceleration section. (Error code: 377)
- (g) If the acceleration/deceleration pattern of the extended parameter is "S-curve drive." (Error code: 378)
- (h) If a 0, or a value greater than 3, is entered for the driving direction. 781)
Enter only 1 (forward direction), 2 (reverse direction), or 3 (current direction) for the driving direction.
- (i) If a negative speed value is designated during the position control operation. (Error code: 782)
If the speed override command of the common parameter Designate& and a value greater than 65,535 is executed for acceleration or deceleration. Error code: 783)

9.6 Auxiliary Function of Control

9.6.1 High/Low limit

Positioning module includes Hardware high/low limit and Software high/low limit.

(1) Hardware High/Low Limit

- (a) This is used to stop the positioning module promptly before reaching Stroke limit/Stroke End of the Driver by installing the stroke limit of positioning module inside Stroke limit/Stroke end of the Driver. In this case, if it is out of the high limit, Error 492 will occur and if it is out of the low limit, Error 493 will occur.
- (b) Input of high/low limit switch is connected to input/out terminal block.
- (c) When positioning module is not in the controllable area, positioning operation is not executed.
- (d) If it is stopped by hardware high/low limit detection, move it into the controllable area with Jog operation in reverse direction of detected signal.
- (e) Hardware high/low limit is shown as follows.

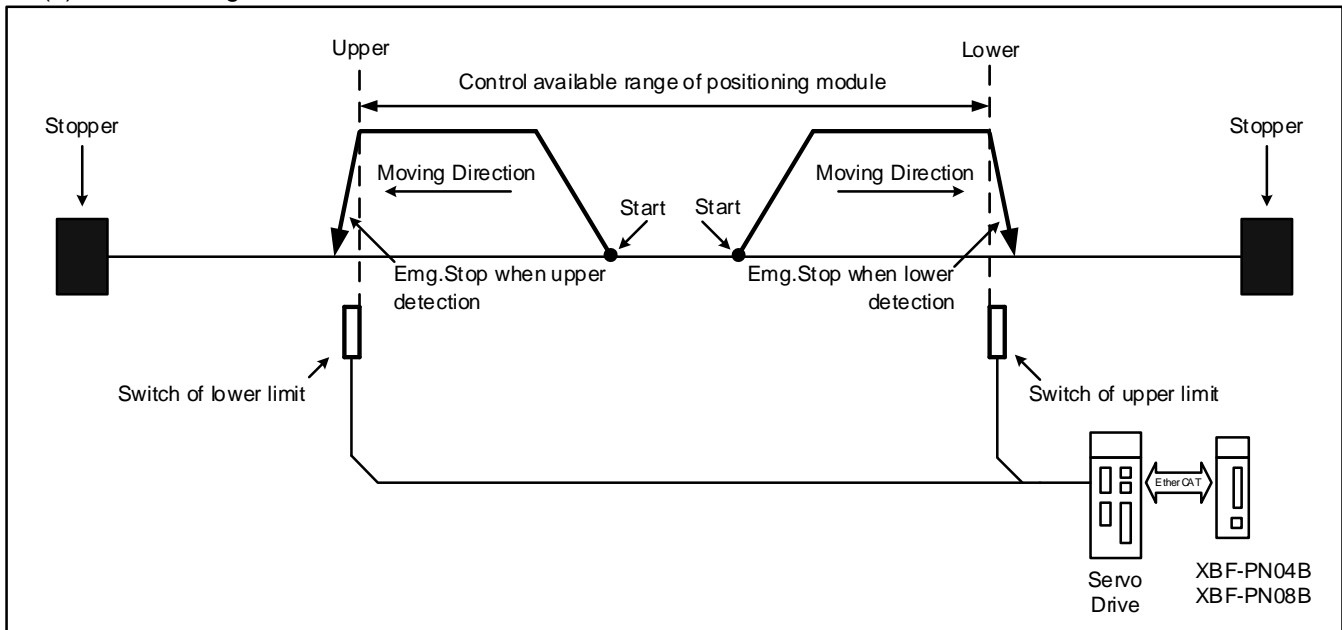

(f) Emergent stop when hardware high/low limit is detected

When hardware high/low limit is detected, stop the current positioning control and then decelerate within “Dec. time for Emergent stop”.

■ Related parameter setting (Basic parameter)

Items	Setting value	Description
Dec. time of Emergent stop	0 ~ 2147483647 [ms]	Set the dec. time for emergent stop. Dec. time for emergent stop means the time needed at decelerating by bias speed.

(2) Software High/Low Limit

- (a) This command is for setting the movable range of machine as software high/low limit. If it is out of the range in operation, stop emergently within dec. time for emergency. In other words, this command is for preventing errors, malfunctions and being out of range.
- (b) If it is out of the range of software high/low limit, set external input high/low limit for use.
- (c) Checking range of software high/low limit is executed at the beginning.
- (d) If software high/low limit is detected, error arises. (High limit error:501, Low limit error:502)
- (e) User may set the position value of high/low limit on extended parameter.

■ Related parameter setting (Extended parameter)

Items	Setting value	Description
Soft High Limit	-2147483648 ~ 2147483647	Set the position of soft high limit
Soft Low Limit	-2147483648 ~ 2147483647	Set the position of soft low limit

- (f) When an object stops because of detection of software high/low limit, move the object within control area by using JOG operation.
- (g) Software high/low limit is shown as follows.

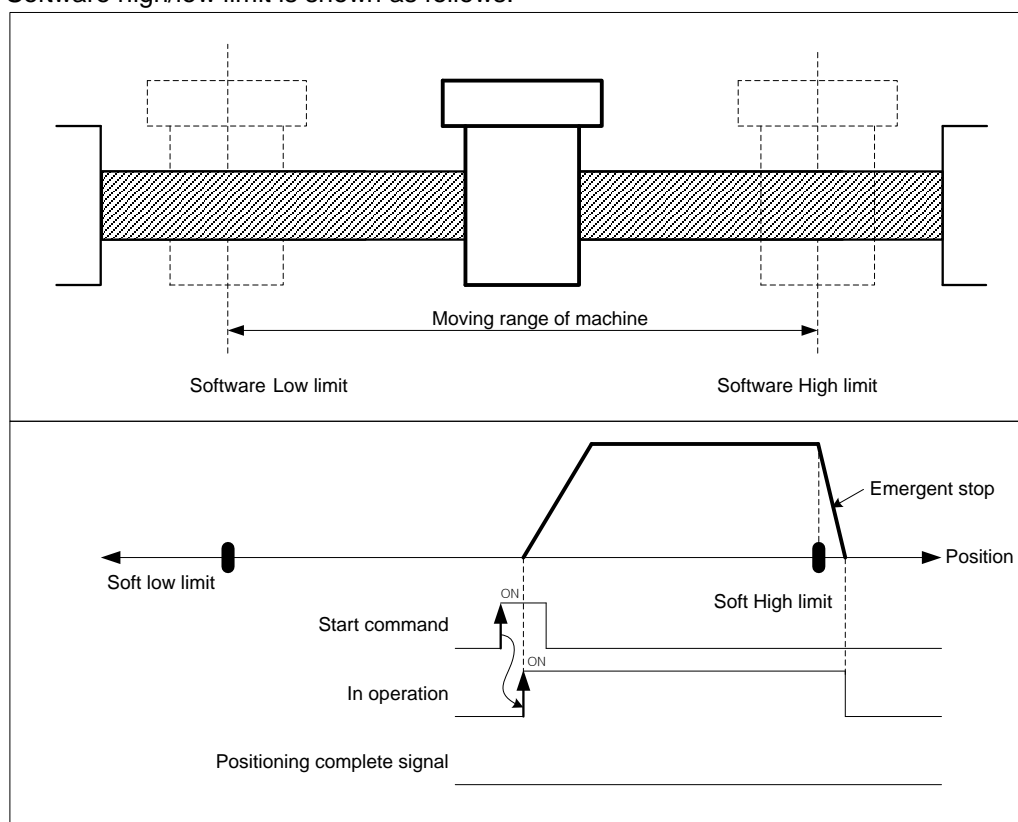

(h) In the case below, software high/low limit are not detected.

- The value of soft high limit 2147483647, the value of soft low limit is -2147483648
- The value of soft high and low limit are same. (High limit = Low limit)

Remark

- (1) It does not detect software high/low limit in origin-undecided state
- (2) Not to detect software high/low limit
If the value of current position becomes 2147483647 in forward operation, the current position becomes -2147483646 and keeps operating in forward direction.
If the value of current position becomes -2147483647 in reverse operation, the current position becomes 2147483646 and keeps operating in reverse direction.
- (3) After EMG. Stop by detection of software upper limit, if position value exceeds position max. value 2147483647 and becomes (-) position value, when executing JOG reverse operation, software lower limit error occurs. In this case, set the software upper/lower limit as max/min value so software limit is not detected and move the object within control area with JOG reverse operation. Then reset the software limit.
- (4) After EMG. Stop by detection of software upper limit, if position value exceeds position min. value -2147483647 and becomes (+) position value, when executing JOG forward operation, software upper limit error occurs. In this case, set the software upper/lower limit as max/min value so software limit is not detected and move the object within control area with JOG forward operation. Then reset the software limit.

9.6.2 M code

This is used to confirm the current operation step no. and carry out the auxiliary work (Clamp, Drill rotation, Tool change etc.) by reading M Code from the program.

(1) Characteristics of Control

- (a) M code should be set in the M code item of operation data.(Setting range : 1 ~ 65535)
- (b) If M code is set as "0", M code signal will not occur.
- (c) If M code occurs, M code no.(1 ~ 65535) and M code signal (On) will occur simultaneously.
- (d) In case of Go-on operation mode, if M code no. and M code signal occur, it becomes standby for the next step; if executing M code release command, it carries out Go-on operation to the next step without start command.
- (e) In continuous operation mode, even if M code no. and M code On signal occur, not to wait but execute continuous operation to the next step.
- (f) User may turn M code signal off and set M code no. to 0 with M code release command. M code release command can be used even during operation.
- (g) M code mode is set from M code output item of extended parameter. (0 : NONE, 1 : WITH, 2 : AFTER)

■ Related parameter setting (Extended parameter)

Items	Setting value	Description
M code mode	0 : None	Not to output M code signal and M code no.
	1 : With	Start and turn M code signal on at the same time, then output M code no. set in operation data.
	2 : After	After finishing positioning by start command, turn M code signal on and then output M code no. set in operation data.

(2) Operation timing

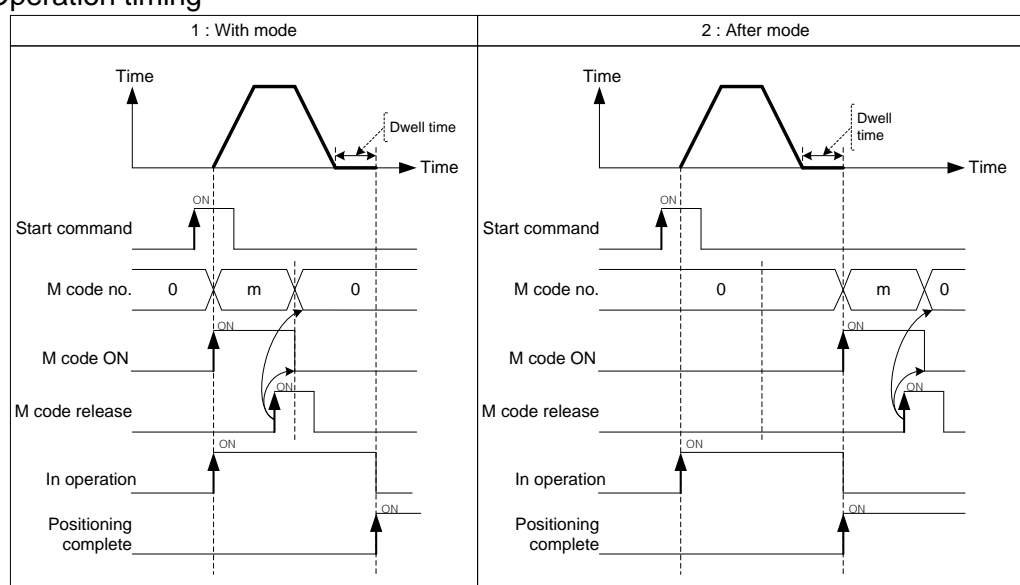

[Example] Set M code no. in operation data as follows and execute absolute, shortcut positioning control.

- Current position of axis1 : 0
M code mode of basic parameter : With

- Setting example in XG-PM
 - Operation data of axis1

Step no.	Control method	Operation method	Goal position [pls]	Operation speed [pls/s]	Acc. no.	Dec. no.	M code	Dwell time
1	Absolute, single-axis positioning control	Singular, continuous	1000	2000	No.1	No.1	100	100
2	Absolute, single-axis positioning control	Singular, continuous	3000	2000	No.1	No.1	200	100
3	Absolute, single-axis positioning control	Singular, continuous	5000	2000	No.1	No.1	300	100

■ Operation pattern

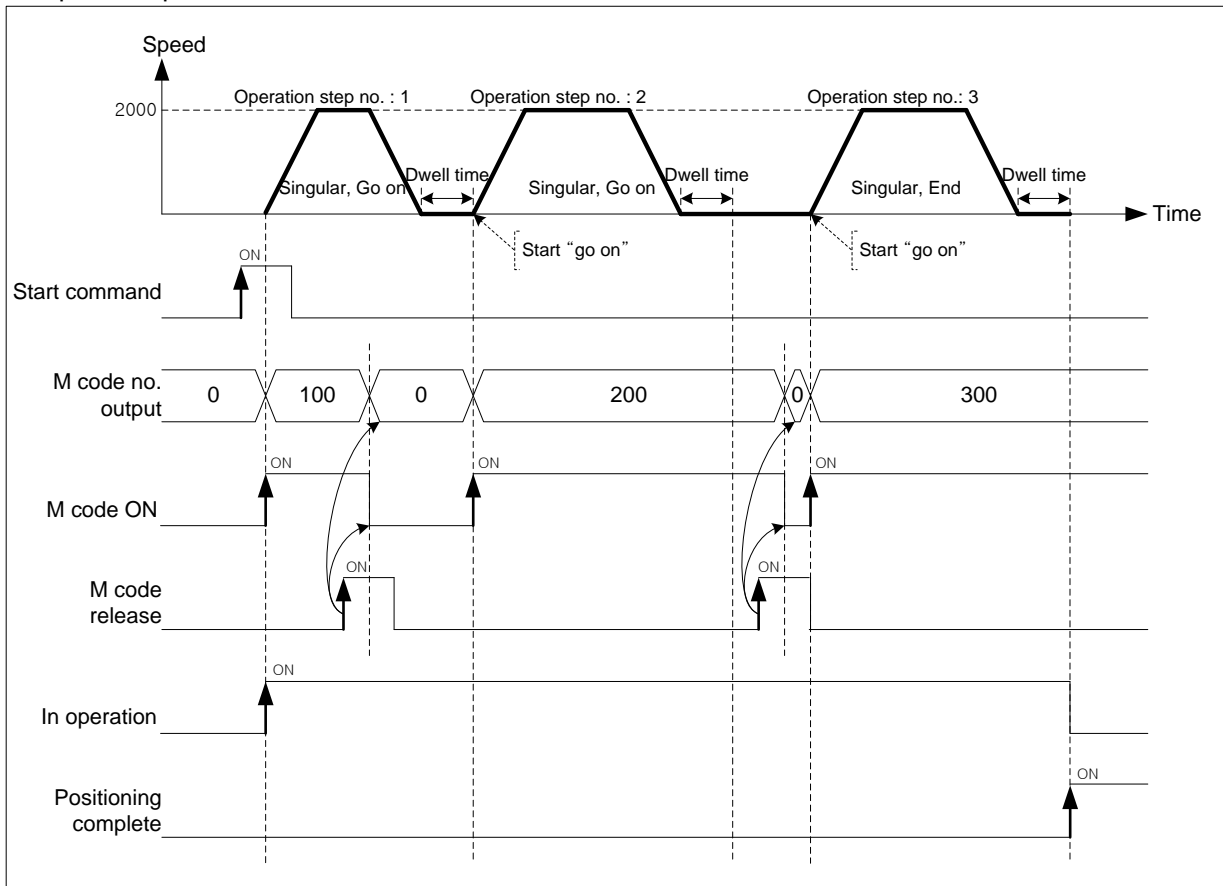

9.6.3 External latch

The latch function supported by XBF- PN04B/PN08B can catch current position of servo drive. And then you can read position data of latch by command from CPU when touch probe 1 of servo drive signal is inputted.

(3) Characteristic of control

- (a) To use the latch features supported by XBF- PN04B/PN08B, please set latch function enable/disable and latch mode by using command of latch setting.

Item	Setting value	Contents
Latch Enable/Disable	0: Disable	Prohibit latch function. It is ignored even if signal of touch probe1 is inputted.
	1: Enable	Enable latch function. Set trigger mode operates if signal of touch probe1 is inputted.
Latch mode	0: Single trigger	After being latch enable, only the first touch probe 1 signal can do latch of current position.
	1: Continuous trigger	After being latch enable, every touch probe 1 signal can do latch.

- (b) The moment that signal of touch probe 1 is on, it saves current position value of servo drive to latch position data.
- (c) The position data of latch can be saved up to 10. When the latch position data is more than 10, it is deleted from the oldest position data of latch and save new latch data. That is, 10 data of latch position data of current is maintained.
- (d) If the signal of touch probe 1 is on to latch is completed, Bit 8: "Complete latch" is on among axis information of status information. The status bit of "Complete latch" is on until reset by command of latch reset(XLCLR, XPM_LCLR).

Item	Setting value	Contents
Item of latch reset	0: Status reset of latch completion	Reset the bit of latch completion among axis information of status information.
	1: Reset of latch position data and latch complete status	Reset latch position data and latch complete status to 0 with the latch completion status to off.

If latch mode is single trigger, you can use latch function by signal of touch probe 1 again with latch reset command that is executed after operating the latch function by the first signal of touch probe 1. (After setting latch set command to enable, it works in the same way when you operate again)

- (e) You can read the number of latch position data and latch position data by reading command of latch position data(XLRD, XPM_LRD) from CPU. Auxiliary data to be used for reading command of latch position data is as follows.

Item	Setting value	Contents
Saving device of latch data	Device	Set the device that the number of latch position data and latch position data is saved.

The value that is saved to device address is as follows.

Device Number	Size	Contents
Device	WORD	The number of latch position data
Device+1	WORD	-
Device+2	DINT	The latch position data 1
Device+4	DINT	The latch position data 2
Device+6	DINT	The latch position data 3
Device+8	DINT	The latch position data 4
Device+10	DINT	The latch position data 5
Device+12	DINT	The latch position data 6
Device+14	DINT	The latch position data 7
Device+16	DINT	The latch position data 8
Device+18	DINT	The latch position position data 9
Device+20	DINT	The latch position data 10

(f) Motion timing(single trigger mode)

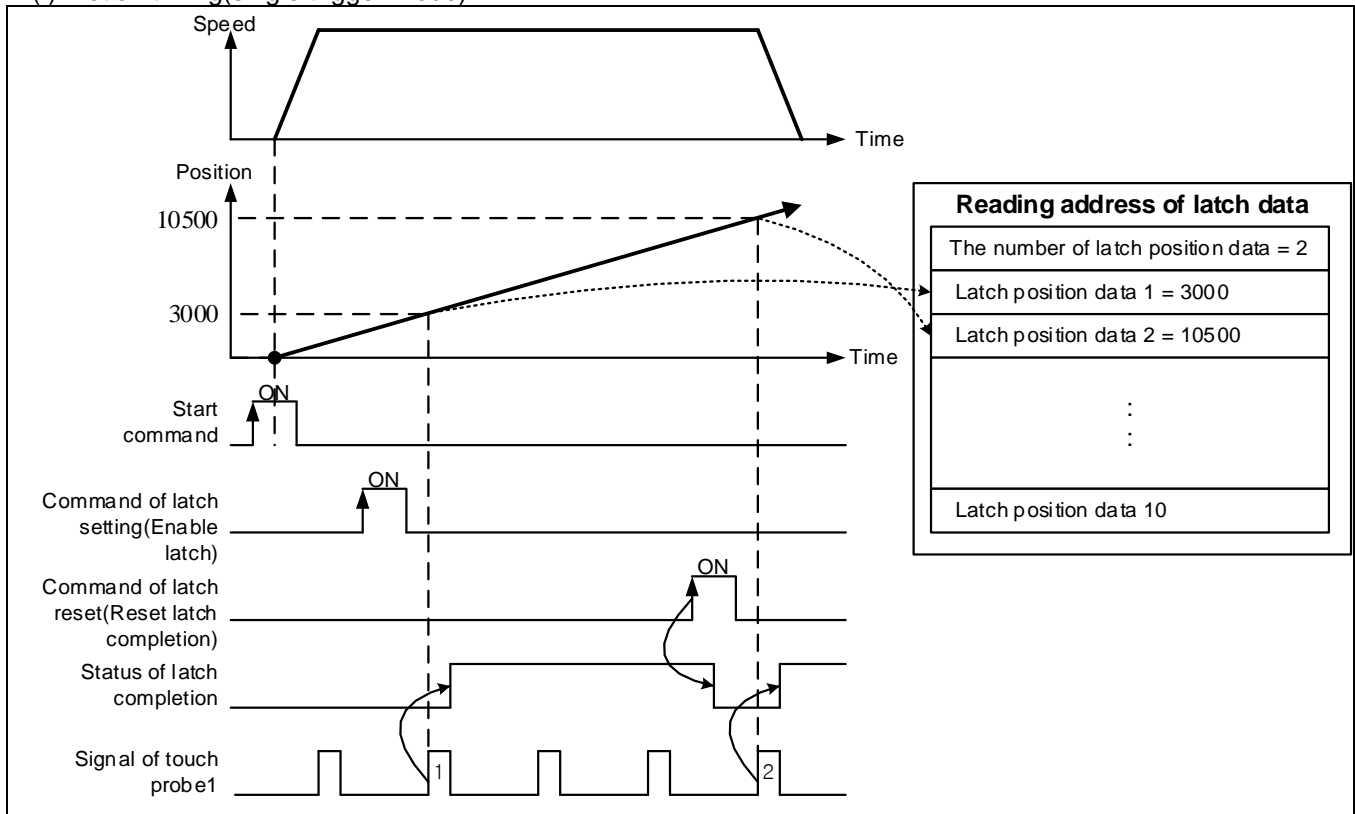

In single trigger mode, only the first touch probe 1 signal can do latch of current position after being latch enable

You can use latch function by signal of touch probe 1 again with latch reset command that is executed after operating the latch function by the first signal of touch probe 1.

(g) Motion timing(Continuous trigger mode)

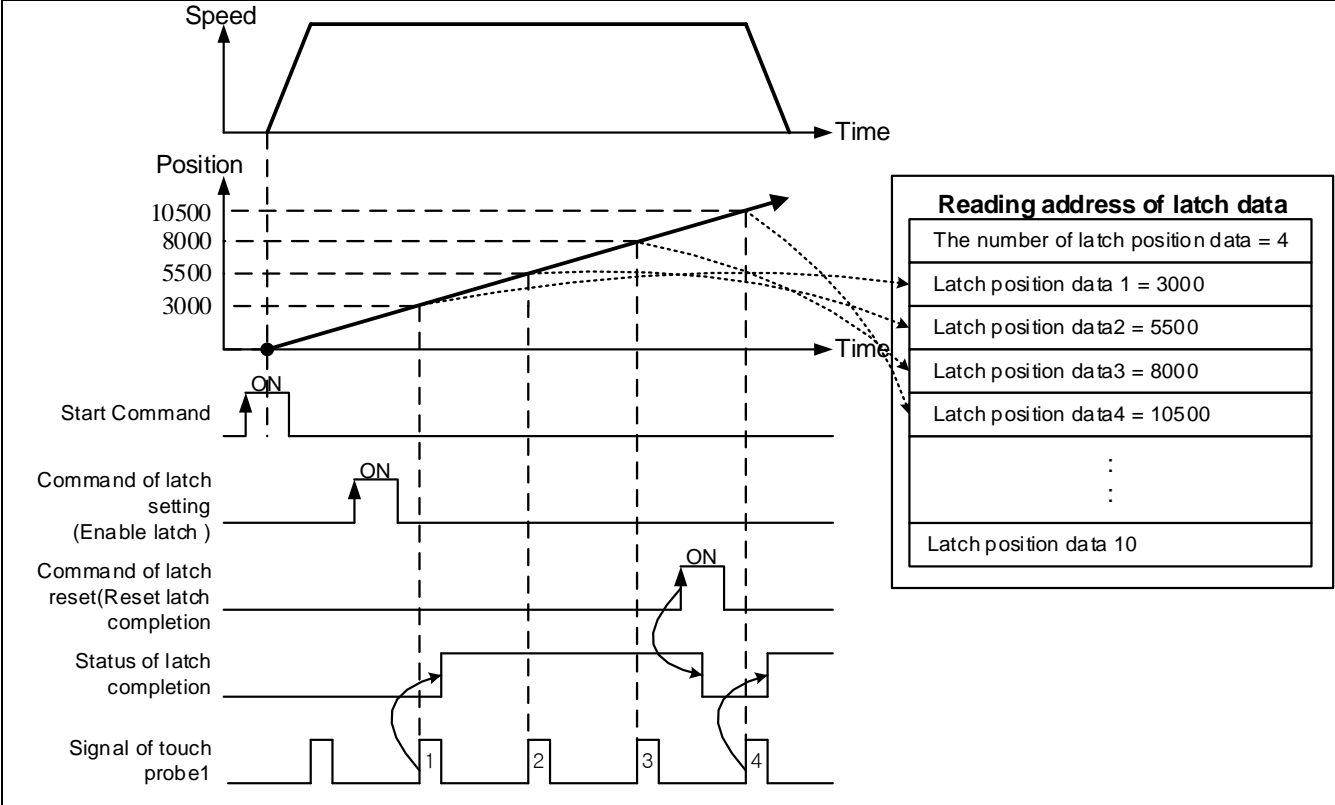

In continuous trigger mode, every touch probe 1 signal can do latch after being latch enable.

9.6.4 Touch Probe

The touch probe function supported by XBF-PN04B/XBF-PN08B can read position data latched by commands in the CPU by latching the current position of a servo drive when the rising or falling edges of the Touch Probe 1 or the Touch Probe 2 of the servo drive are triggered.

(5) Characteristics of Control

- (a) To use the touch probe function supported by XBF-PN04B/XBF-PN08B, you should set a trigger input signal and a trigger mode through the command to set touch probes. The auxiliary data used in the command to set touch probes is as follows:

Item	Setting value	Content
Trigger input	0: Rising Edge of the Touch Probe 1	Save the position data triggered from the rising edge of the Touch Probe 1.
	1: Rising Edge of the Touch Probe 2	Save the position data triggered from the rising edge of the Touch Probe 2.
	2: Falling Edge of the Touch Probe 1	Save the position data triggered from the falling edge of the Touch Probe 1.
	3: Falling Edge of the Touch Probe 2	Save the position data triggered from the falling edge of the Touch Probe 2.
	4: Index (Z) Pulse of the Touch Probe 1	Save the position data triggered from the index (Z) pulse of the Touch Probe 1.
	5: Index (Z) Pulse of the Touch Probe 2	Save the position data triggered from the index (Z) pulse of the Touch Probe 2.
Trigger Mode	0: Single trigger	The current position is latched only by the first touch probe signal to be input.
	1: Double trigger	The current position is latched by every touch probe signal.

- (b) When touch probes or index (Z) pulse signals are turned on, the current position value of a servo drive is saved in the position data.
- (c) When touch probes or index (Z) pulse signals are turned on and the latch is completed, information is saved in Bit 5: "Trigger is Completed" of axis information under the status information. The "Trigger is Completed" status bit remains 'On' until it is reset by trigger abortion commands (XABORTT, XPM_ABORTT). The auxiliary data used in trigger abortion commands is as follows.

Item	Setting value	Content
Trigger input	0: Rising Edge of the Touch Probe 1	Abort trigger setting of the rising edge of the Touch Probe 1.
	1: Rising Edge of the Touch Probe 2	Abort trigger setting of the rising edge of the Touch Probe 2.
	2: Falling Edge of the Touch Probe 1	Abort trigger setting of the falling edge of the Touch Probe 1.
	3: Falling Edge of the Touch Probe 2	Abort trigger setting of the falling edge of the Touch Probe 2.
	4: Index (Z) Pulse of the Touch Probe 1	Abort trigger setting of the index (Z) pulse of the Touch Probe 1.
	5: Index (Z) Pulse of the Touch Probe 2	Abort trigger setting of the index (Z) pulse of the Touch Probe 2.
Trigger Reset Items	0: Reset the status that completes triggers	Reset the trigger completion bit of axis information under the status information.
	1: Reset the status that completes triggers and the data of latch positions	Turn off the trigger completion status and reset the number of latch position data and the latch position data to 0.

- (d) When a latch mode is a single trigger, if you run a trigger abortion command after a latch function operates in the first touch probe or index (Z) pulse signal, you can use a trigger function again in the following touch probe or index (Z) pulse signal: (Even if you run a touch probe setting command again, it operates identically.)
- (e) Index (Z) pulse, and rising and falling edges of each touch probe can not be run simultaneously.
- (f) You can designate an area where a latch (touch probe) function operates.

- If a tolerance area is designated, you can let it operate only within the designated area.
- When it is an infinite repeating operation (a rotational axis), its relationship with a latch (touch probe) operation area according to the start and end positions of a tolerance area is as follows:

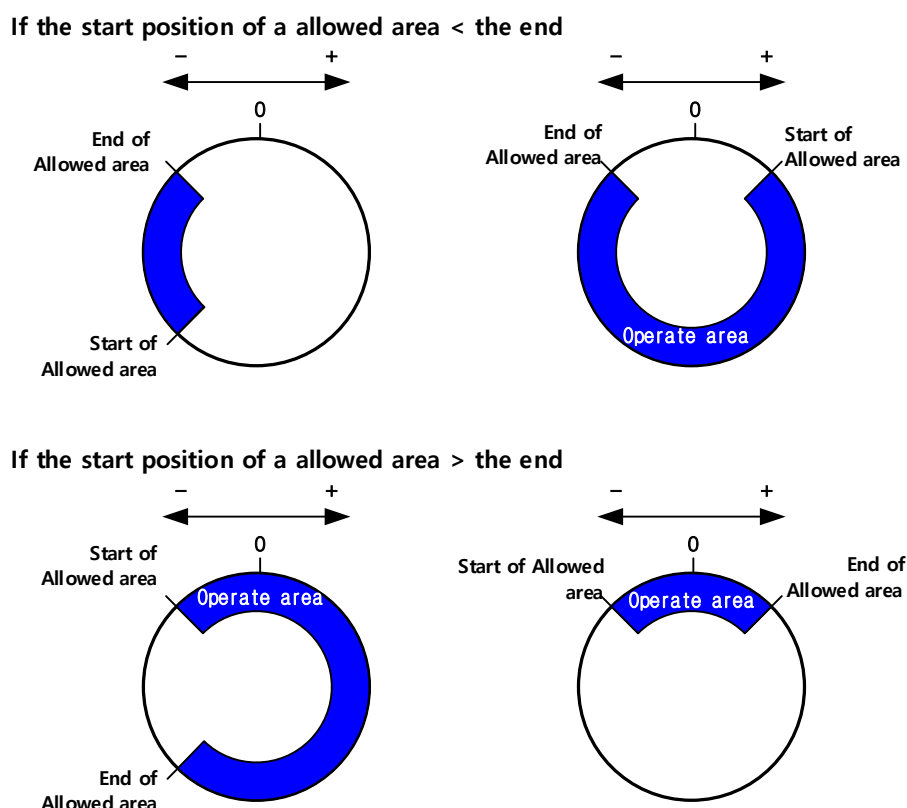

(g) To use a latch (touch probe) function, the PDO setting of a slave parameter must include the following object.

Trigger input	RxPDO	TxPDO
The Rising Edge of the Touch Probe 1	0x60B8:0 Touch Probe Function	0x60B9:0 Touch Probe Status 0x60BA:0 Forward Position Value of the Touch Probe 1
The Rising Edge of the Touch Probe 2	0x60B8:0 Touch Probe Function	0x60B9:0 Touch Probe Status 0x60BC:0 Forward Position Value of the Touch Probe 2
The Falling Edge of the Touch Probe 1	0x60B8:0 Touch Probe Function	0x60B9:0 Touch Probe Status 0x60BB:0 Forward Position Value of the Touch Probe 1
The Falling Edge of the Touch Probe 2	0x60B8:0 Touch Probe Function	0x60B9:0 Touch Probe Status 0x60BD:0 Forward Position Value of the Touch Probe 2

(h) If using a latch command when there are not the above objects, the following errors occur according to each trigger input:

Trigger input	Error code
The Rising Edge of the Touch Probe 1	752
The Rising Edge of the Touch Probe 2	753
The Falling Edge of the Touch Probe 1	754
The Falling Edge of the Touch Probe 2	755

- (i) With the read command (XLRD, XPM_LRD) of latch position data in the CPU you can read the number of latch position data and the latch position data. The auxiliary data using the read command of latch position data is as follows:

Item	Setting value	Content
Latch data Saving device	Device	Set the device where the number of latch position data and the value of latch position data are saved.

9.7 Data Modification Function

This function is for changing operation data and operation parameter of positioning module.

9.7.1 Teaching Array

User may change the operating speed and the goal position of the step user designated with teaching command but without XG-PM.

(1) Characteristics of Control

- (a) This command is for changing operating speed or the goal position on several steps.
- (b) User may change maximum 16 data.
- (c) RAM teaching and ROM teaching are available depending on the saving position.

■ RAM teaching

When executing teaching to operation data of positioning module and operating positioning module in power connection, user may change speed value or position value but the speed value and position value are not saved in non-power connection.

■ ROM teaching

When executing teaching to operation data of positioning module and operating positioning module in power connection, user may change speed value or position value and operation data is saved permanently by saving operation data to MRAM(non-volatility memory) even in non-power connection.

- (d) The value of goal position being changed is position teaching, the value of operating speed being changed is speed teaching.
- (e) The axis in operation may be the subject of position teaching or speed teaching.
- (f) If user changes the value of goal position or operating speed frequently, this command is very useful for it.
- (g) Auxiliary data setting of teaching array command

Items	Setting value	Description
Step	0 ~ 400	Set the step no. for teaching
Position	0 : RAM teaching 1 : ROM teaching	Set the method of teaching
Data	0 : Position 1 : Speed	Set the data items for teaching
The No.	1 ~ 16	Set the number of operating step

- (h) Even though teaching can be performed even when the axis subject to teaching is being operated but, only the current step's data is reflected after the current step operation is completed if the step that is currently running is within the step area while other steps' data are immediately changed.

Remark

The teaching data must be set in the data setting area for teaching array before teaching array command is executed. Refer to the teaching array command XTWR.

(2) Restrictions

Teaching array command may not be executed in the case as follows.

- (a) The number of teaching array is out of the range (1~16). (Error code: 462)
- (b) Teaching step no. is out of the range (1~400). (Error code: 465)

Total number(Teaching step no. + number of Teaching) must be below 400.

9.7.2 Parameter Change from Program

User may modify the operation parameter set on XG-PM with teaching command for each parameter.

(1) Characteristics of Control

- (a) There are 6 kinds of parameter teaching command. (Basic, Extended, Manual operation, Homing, External signal, common parameter teaching)
- (b) Parameter teaching is not available in operation.
- (c) RAM teaching and ROM teaching are available depending on the saving position.

- RAM teaching

When users execute teaching to operation data and operate positioning module in power connection, it can be used by changing the value of the speed and position. But the speed value and position value are not saved in non-power connection.

- ROM teaching

When users execute teaching to operation data and operate positioning module in power connection, it can be used by changing the value of the speed and position. And the parameter value that was used in the existing can be saved to MRAM (non-volatility memory) even in non-power connection.

(2) Basic Parameter Teaching

- (a) Change the setting value of designated item from basic parameter of positioning module into teaching data.
 (b) Auxiliary data setting of basic parameter teaching command

Item	Setting value		Description	
Teaching data	Refer to "setting range"		Set the teaching value of parameter selected	
			Setting range	
Teaching item	1	Speed limit	1 ~ 2147483647	Choose the parameter item to do execute teaching
	2	Acc.time 1	0 ~ 2147483647	
	3	Acc.time 2		
	4	Acc.time 3		
	5	Acc.time 4		
	6	Dec.time 1		
	7	Dec.time 2		
	8	Dec.time 3		
	9	Dec.time 4		
	10	Emergent Dec.time		
	11	Demultiply output pulse/rotation		
	12	Transferring distance/rotation	Depend on "Unit"	
	13	Unit	0:pulse 1:mm 2:inch 3:degree	
	14	Double precision of unit	0:x1 1:x10 2:x100 3:x1000	
	15	Speed unit	0: unit/time 1: rpm	
	16	Encoder selection	0: incremental encoder 1: absolute encoder	
	17	Current position display correction	0 ~ 255	
	18	User defined position display scale	0 ~ 7	
	19	User defined speed display scale	0 ~ 7	
	20	Axis type	0: Real axis 1: Virtual Axis	
Teaching method	0 : RAM Teaching 1 : ROM Teaching		Set the teaching method	

For the details about basic parameter items and setting value, refer to "Chapter 4 parameter and operation data".

(3) Extended Parameter Teaching

(a) Change the setting value of designated item from extended parameter of positioning module into teaching data.

(b) Auxiliary data setting of extended parameter teaching command

Items	Setting value		Description
Teaching data	Refer to "Setting range"		Set the teaching value of parameter selected
			Setting value
Teaching items	1	Soft high limit	-2147483648 ~ 2147483647
	2	Soft low limit	-2147483648 ~ 2147483647
	3	-	-
	4	Positioning complete Output time	0 ~ 65535
	5	Ratio of S-curve	1 ~ 100
	6	In-position width	0 ~ 2147483647
	7	2 axes linear interpolation continuous operation arc insertion position	0 ~ 2147483647
	8	Acc./Dec. Pattern	0 : Trapezoid operation 1 : S-curve operation
	9	M code mode	0 : None 1 : With 2 : After
	10	Soft high/low limit In speed control	0 : Don't detect 1 : Detect
	11	Condition for positioning complete	0 : Dwell time 1 : In-position signal 2 : Dwell time AND In-position signal 3 : Dwell time OR In-position signal
	12	Positioning method of interpolation continuous operation	0 : Pass the goal position 1 : Pass near position
	13	2 axes linear interpolation continuous operation arc insertion	0 : Don't insert arc 1 : Insert arc
	14	External command selection	0 : External speed/position control switching 1 : External stop
	15	External command	0 : Enable 1 : Disable
	16	Position-specified speed override coordinate	0 : Absolute 1 : Incremental
	17	Infinite running repeat position	mm: 1 ~ 2147483647[X10 ⁻⁴ mm] Inch: 1 ~ 2147483647[X10 ⁻⁵ Inch] degree: 1 ~ 2147483647[X10 ⁻⁵ degree] pulse: 1 ~ 2147483647[pulse]
	18	Infinite running repeat	0: disable, 1: enable
	19	Speed/position switching coordinate	0: incremental, 1: absolute
	20	Interpolation speed selection	0: main-axis speed 1: synthetic speed
Teaching method	0 : RAM teaching 1 : ROM teaching		Set the teaching method

Select the parameter item to execute teaching

For the details about basic parameter items and setting value, refer to "Chapter 4 parameter and operation data".

(4) Manual Operation Parameter Teaching

(a) Change the setting value of designated item from manual operation parameter of positioning module into teaching data.

(b) Auxiliary data setting of manual operation parameter teaching command

Items	Setting value	Description
Teaching data	Refer to "setting range"	Set the teaching value of parameter selected
Teaching items	1 Jog high speed	1~ Speed limit
	2 Jog low speed	1 ~ Jog high speed
	3 Jog acc. time	0 ~ 2147483647
	4 Jog dec. time	
	5 Inching speed	1 ~ Speed limit
Teaching method	0 : RAM teaching 1 : ROM teaching	Set the teaching method

For the details about basic parameter items and setting value, refer to "Chapter 4 parameter and operation data".

(5) Input signal parameter teaching

(a) It changes the settings value of the input signal parameters of the positioning module to teaching data.

(b) The meaning of each bit of setting value of input signal parameter teaching command.

15	14	13	12	11 ~ 8	7 ~ 4	3 ~ 0
-	Logic selection of input signal Z	Logic selection of input signal B	Logic selection of input signal A	Function selection of input signal Z	Function selection of input signal B	Function selection of input signal A

Content and the set value of parameter item details input signal, please refer to Chapter 4.

(6) Input signal parameter - Switching torque of external position/torque control teaching

(a) It changes the torque value of the switching of external location / torque control of input signal parameters of the positioning module to teaching data

(b) Setting range of torque values are as follows..

-32768 % ~ 32767 %

Content and the set value of parameter item details input signal, please refer to Chapter 4.

(7) Common Parameter Teaching

(a) Change the setting value of designated item from common parameter of positioning module into teaching data.

(b) Auxiliary data setting of common parameter teaching command

Items	Setting value		Description	
Teaching data	Refer to "setting range"		Set the teaching value of parameter selected	
			Setting range	
Teaching items	1	Speed override	0 : % setting 1 : speed setting	Select the parameter item to execute teaching
	2	Encoder1 pulse input	0 : CW/CCW 1 multiplying 1 : PULSE/DIR 1 multiplying 2 : PULSE/DIR 2 multiplying 3 : PHASE A/B 1 multiplying 4 : PHASE A/B 2 multiplying 5 : PHASE A/B 4 multiplying	
	3	Max. value of encoder1	-2147483648 ~ 2147483647	
	4	Min. value of encoder1		
	5	Encoder1 Z phase clear	0: Disable 1: Enable	
	10	Destination coordinates for positioning speed synchronization	0:incremental, 1:absolute,	
	11	Encoder 1 average number	0:None 1: 5 2:10 3:20	
	13	Function selection of external input terminal	0: A,B,Z phase of encoder signal 1: External input signal A,B,Z	
	14	Input filter of external input signal	0: Disable, 1: Enable	
Teaching method	0 : RAM teaching 1 : ROM teaching		Set the teaching method	

For the details about basic parameter items and setting value, refer to "Chapter 4 parameter and operation data".

9.7.3 Data Change from Program

User may modify the positioning operation data set on XG-PM with operation data teaching command.

(1) Characteristics of Control

- (a) Change setting value of designated step and item from positioning module's operation data into teaching data.
- (b) Operation data setting command is available to be executed when the axis is operating. However, if operation data of the step that is currently operated are changed, those changes are reflected after the current step is completed.
- (c) RAM teaching and ROM teaching are available depending on the saving position.

- RAM teaching

When executing teaching to operation data of positioning module and operating positioning module in power connection, user may change speed value or position value but the speed value and position value are not saved in non-power connection.

- ROM teaching

When executing teaching to operation data of positioning module and operating positioning module in power connection, user may change speed value or position value and operation data is saved permanently even in non-power connection.

(d) Auxiliary data setting of operation data teaching command

Items	Setting value		Description
Teaching data	Refer to "Setting range"		Set the teaching value of parameter selected
	Setting range		
Teaching items	1	Goal position	-2147483648 ~ 2147483647
	2	Auxiliary point of Circular interpolation	-2147483648 ~ 2147483647
	3	Operating speed	1 ~ Speed limit
	4	Dwell time	0 ~ 65535
	5	M code	0 ~ 65535
	6	Set a sub axis	Set it on Bit 0 ~ Bit 7 0 : Not be set 1 : Be set
	7	Helical interpolation	0 : Not use 1 ~ 8 : axis1 ~ axis8
	8	No. of circular interpolation turn	0 ~ 65535
	9	Coordinate	0 : Absolute 1 : Incremental
	10	Control method	0 : Single-axis position control 1 : Single-axis speed control 2 : Single-axis Feed control 3 : Linear interpolation control 4 : Circular interpolation control
	11	Operating method	0 : Single 1 : Repeat
	12	Operating pattern	0 : End 1 : Keep 2 : Continuous
	13	Size of circular arc	0 : Circular arc < 180 1 : Circular arc >= 180
	14	Acc. no.	0 ~ 3
	15	Dec. no.	0 ~ 3
	16	Method of circular interpolation	0 : Middle point 1 : Center point 2 : Radius
	17	Direction of circular interpolation	0 : CW 1 : CCW
Step no.	0 ~ 400		Set the step no. of operation data to execute teaching
Teaching method	0 : RAM Teaching 1 : ROM Teaching		Set the teaching method

Select the parameter item to execute teaching

For the details about basic parameter items and setting value, refer to "Chapter 4 parameter and operation data".

9.7.4 Write/Read Variable Data

Parameter, operation data, CAM data can be read by “Read Variable Data” command and written by “Write Variable Data” command directly.

(1) Read Variable Data

- You read data you want by designating module internal memory address of parameter, operation data, CAM data directly.
- Reads data as many as “Block size” starting position set in “Read address” with WORD unit to CPU among parameter, operation data, CAM data. In case “CNT” is higher than 2, reads blocks with interval of “Block offset” starting “Read address” as many as “CNT”-1.
- Max. data size (block size x No. of block) you can read with one command is 128 WORD
- “Read Variable Data” command can’t be executed in operation.
- Auxiliary data setting of “Read Variable Data” command

Item	Setting value	Description
Read address	0 ~73769	Sets head address of Read Data
Block offset	0 ~73769	Sets offset between blocks of Read Data
Block size	1 ~ 128	Sets size of block
No. of block	1 ~ 128	Sets No. of Read Block

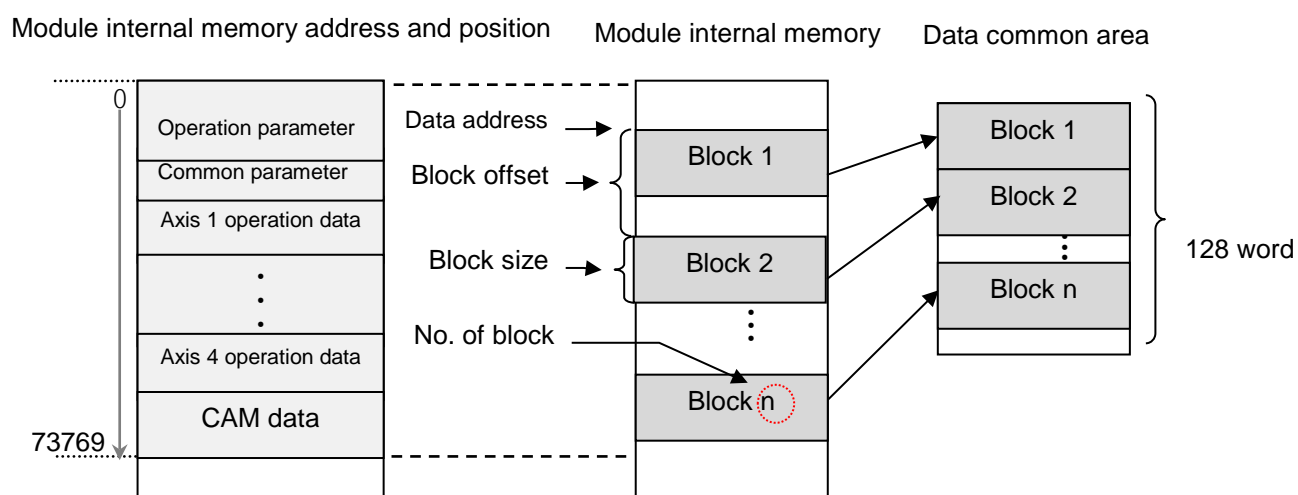

(f) Restriction

In the following case, error occurs and can't execute “Read Variable Data” command

- Data setting error (Error code: 711)
 - Read data size (Block size x No. of block) is 0 or higher than 128 WORD.
 - Read data address [Read address + {block offset x (No. of block -1)} + Block size] is higher than last address value (73768)

Remark

If you execute “Read Variable Data” command in XGK PLC, Read data from positioning module is saved in common area. To save in device for using in PLC program, use GETM command [Read address: 0, data size: Read data size (DWORD)]
 In XGI/XGR PLC, Read data is saved in register set in Function Block automatically.

(2) Write Variable Data

- (a) You write data you want by designating module internal memory address of parameter, operation data, CAM data directly.
- (b) Writes data set in PLC program as many as “Block size” starting position set in “Write address” with WORD unit among parameter, operation data, CAM data of positioning module. In case “No. of block” is higher than 2, writes blocks with interval of “OFFSET” starting “Write address” as many as “CNT”-1.
- (c) Max. data size (Block size x No. of block) you can write with one command is 128 WORD.
- (d) “Read Variable Data” command can’t be executed in operation. But changing the user cam data of relevant axis is available about an axis in the cam control operation.
- (e) After executing “Write Variable Data” command, since the changed value is maintained while power is on, in order to keep the changed value, execute “Save parameter/Operation data” command
- (f) Auxiliary data setting of “Write Variable Data” command

Item	Setting value	Description
Data device	-	Sets device where data to write to module is saved
Write address	0 ~ 73769	Sets head address of positioning module internal memory
Block offset	0 ~ 73769	Sets offset between blocks of Write data
Block size	1 ~ 128	Sets size of block
No. of block	1 ~ 128	Sets No. of Write block

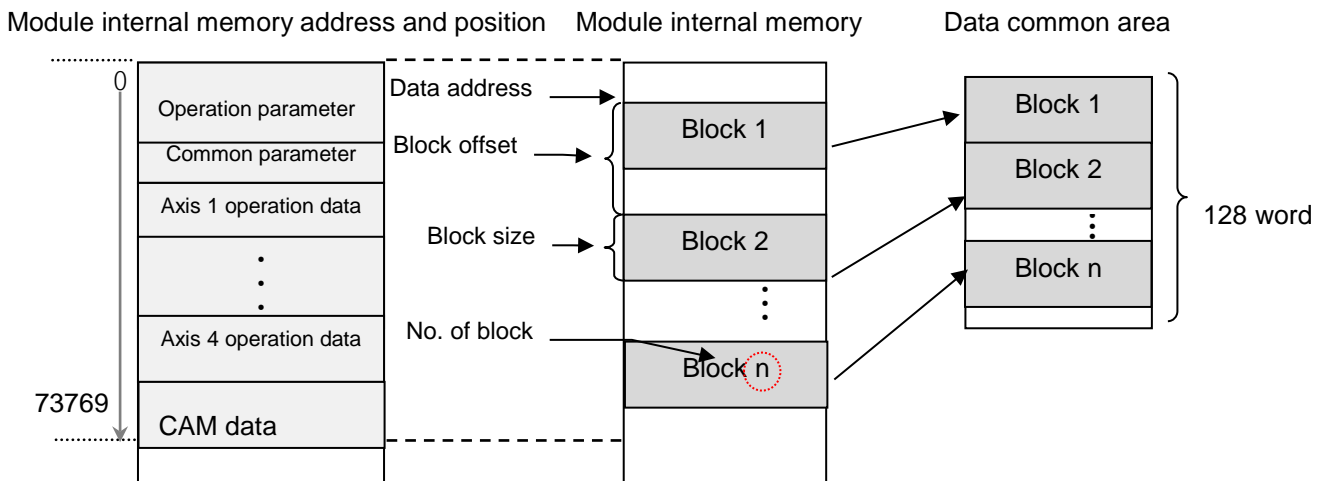

(g) Restriction

In the following case, error occurs and can't execute "Read Variable Data" command

- Data range setting error (Error code: 711)
 - Write data size (Block size x No. of block) is 0 or higher than 128 WORD
 - Write data address [Write address + {Block offset x (No. of block - 1)} + Block size] is higher than last address value (73769)
- Block overlap error (Error code: 713)
 - In case module internal block to write is overlapped each other (In case no. of block is higher than 2, block offset is smaller than block size)
- Execution inhibition error in operation (Error code: 712)
 - Any axis of positioning module is in operation

9.8 User Defined Position / Speed Display Function

The user sets the desired magnification as parameters for the position and speed and converts them to 'user defined position' , 'user defined speed' values for use.

9.8.1 User Defined Position / Speed Reflection Item

The following items of the status information are converted to user defined position and speed for use.

- (1) Current Position.
- (2) Current Speed
- (3) Command Position
- (4) Command Speed

9.8.2 Add Parameters

Parameters related to the user defined position / speed function are as follows.

	Items	Setting value
Common Parameter	User defined position display scale	0 ~ 7
	User defined speed display scale	0 ~ 7

9.8.3 Operation principles

User defined position / speed magnification are applied to the position and speed as follows.

(1) Position

User defined position = Unit position x 10^{-N} (integer value, omit decimals)

- ※ 'Unit position': The command position integer value or current position read by SRD command
- ※ N:'User defined position display magnification' of the basic parameter (0 ~ 7)
- ※ If N = 0, user defined position and unit position values are the same
- ※ Unit=mm, unit position=1000000, user defined position display magnification = 4

Items	Setting value	Description
Unit Position	100000	The read value from CPU by SRD command
XG-PM System view	100000.0 um	-
User defined position	100	Unit [mm]

(2) Speed

User defined speed = Unit speed x 10^{-N} (integer value, omit decimals)

- ※ 'Unit speed' : The command speed integer value or current speed read by SRD command
- ※ N: 'User defined speed display magnification' of the basic parameter (0 ~ 7)
- ※ if N = 0, user defined speed and unit speed values are the same
- ※ Unit = mm, unit speed = 10000, user defined speed display magnification = 2

Items	Setting value	Description
Unit Speed	10000	The read value from CPU by SRD command
XG-PM System view	100.0 mm/m	-
User defined position	100	Unit [mm/m]

9.8.4 How to check user defined position / speed

User defined position / speed can be checked by reading the following common memory address with GET command.

GET Device offset	Memory address								Description
	1Axis	2Axis	3Axis	4Axis	5Axis	6Axis	7Axis	8Axis	
0	B8	F8	138	178	1B8	1F8	238	278	User defined current position(Lower)
1	B9	F9	139	179	1B9	1F9	239	279	User defined current position(Upper)
2	BA	FA	13A	17A	1BA	1FA	23A	27A	User defined current speed(Lower)
3	BB	FB	13B	17B	1BB	1FB	23B	27B	User defined current speed (Upper)
4	BC	FC	13C	17C	1BC	1FC	23C	27C	User defined command position(Lower)
5	BD	FD	13D	17D	1BD	1FD	23D	27D	User defined command position(Upper)
6	BE	FE	13E	17E	1BE	1FE	23E	27E	User defined command speed(Lower)
7	BF	FF	13F	17F	1BF	1FF	23F	27F	User defined command speed (Upper)

(1) Example of use

- 1) Method to check 2-axis user defined command position of the positioning module mounted on BASE=0, SLOT=2



- 2) Method to check 1-axis user defined position/speed of the positioning module mounted on BASE=0, SLOT=2

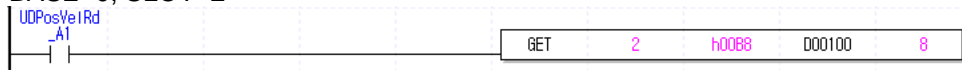

Appendix1. Positioning Error Information & Solutions

Here describes the positioning error types and its solutions.

App1.1. Error Information of Basic Parameter

Error Code	Error Description	Solutions
101	Speed limit value of Basic Parameter exceeds the range	Speed limit value of Basic Parameter is 1 ~ 20,000,000 based on pulse unit.
104	Speed limit of basic parameter by degree is bigger than 180out of range, so circular interpolation cannot be executed.	Operate with lower speed limit of Circular Interpolation

App1.2. Error Information of Expanded Parameter

Error Code	Error Description	Solutions
111	Extended Parameter software high/low limit range error	S/W high limit of Extended Parameter should be greater than or equal to S/W low limit of Extended Parameter.
112	M Code Mode value of Extended Parameter exceeds the range.	M Code output of Extended Parameter is 0:None, 1:With, 2:After. Select one among three.
113	S-Curve rate of Extended Parameter exceeds the range.	Change S-Curve rate of Extended Parameter to be more than 1 and less than 100.

App1.3. Error Information of Manual Operation Parameter

Error Code	Error Description	Solutions
121	Jog high speed value of Manual operation parameter exceeds the range.	Set Jog high speed of Manual operation parameter to be greater than or equal to bias speed of Basic Parameter and less than or equal to max. speed of Basic Parameter.
122	Jog low speed value of Manual operation parameter exceeds the range.	Set Jog low speed of Manual operation parameter to be more than 1 and less than Jog high speed of Manual operation parameter.
123	Inching speed value of Manual operation parameter exceeds the range.	Set Inching speed of Manual operation parameter to be greater than or equal to bias speed of Basic Parameter and less than or equal to max. speed of Basic parameter.

App1.4. Error Information of Common Parameter

Error Code	Error Description	Solutions
141	Encoder type value of Common parameter exceeds the range.	Set Encoder input signal of Common parameter to be between 0 and 5.
148	Encoder1 max/min value of common parameter Exceeds the range.	Set Encoder max value smaller than min value, also set encoder max/min value contains current position.

App1.5. Error Information of Operating Data

Error Code	Error Description	Solutions
151	Not available to set operation speed value of Operation data as "0".	Set operation speed to be greater than "0".
152	Operation speed of Operation data exceeds max. speed value.	Set operation speed to be less than or equal to max. speed set in the Basic Parameter.
155	Exceeds End/Go on/Continuous operation setting range of Operation data.	Set one from operation pattern (0:End, 1:Go on, 2: Continuous) of operation data to operate
156	Even the operation pattern settled continuous, next command cannot support continuous operation.	Set for abstract positioning control or speed control. If it is for current step command then next step command should be a interpolation command.
157	Even the operation pattern settled continuous, next command cannot support axis of current command.	If operation pattern is continuous, them set both Operation data and next step operation data equally
158	Even the operation pattern set continuous, current command cannot support continuous current command.	Continuous operation only can be operated when it is shortening position control, linear interpolation, and circular interpolation. In other commands, set operation option to end or continuous.
159	Goal position of operation data exceeds the range.	For positioning control operating change goal position more than 2,147,483,648 and less than 2,147,483,647.

App1.6. Error Information of Data Writing

Error Code	Error Description	Solutions
171	Parameter writing command cannot be done because of start command execution while XG-PM is sending common parameter.	Once current operation is done, eliminate error with error-reset command, and then execute writing command again. Do not execute start operation while parameter sending.
172	Parameter writing command cannot be done because of start command execution while XG-PM is sending operating parameter.	Once current operation is done, eliminate error with error-reset command, then execute writing command again. Do not execute start operation while parameter sending.
173	Parameter writing command cannot be done because of start command execution while XG-PM is sending operating data.	Once current operation is done, eliminate error with error-reset command, then execute writing command again. Do not execute start operation while operating data sending.
174	Parameter writing command cannot be done because of start command execution while XG-PM is sending CAM data.	Once current operation is done, eliminate error with error-reset command, then execute writing command again. Do not execute start operation while CAM data sending.
175	Start command cannot be executed while writing sending-parameters or operating-data from XG-PM.	Execute again once writing of parameter or operating data are done.
176	Servo parameter writing command cannot be done because of start command execution while XG-PM is sending parameter data.	After current operation is done, remove error with Error reset and write servo parameter again. Don't execute start command during servo parameter transmission

App1.7. Error Information of positioning command and Auxiliary Step control

Error Code	Error Description	Solutions
201	Not possible to carry out Homing command in the state of in operation.	Check if command axis is in operation when the Homing command is executed.
203	Not possible to carry out Homing command in the state of Servo Ready OFF.	Check if Driver Ready signal of command axis is OFF when Homing command is executed.
205	Not possible to carry out Home Return, because servo driver doesn't support Home return mode	Unable to carry out Home return in that servo driver
206	Not possible to complete reading home offset	Check the status of the servo driver and execute Home return command
207	Error occurs during home return	Check if Home return method is available for the servo driver and execute Home return again
211	Not possible to carry out Floating origin setting command in the state of in operation.	Check if command axis is in operation when Floating origin setting command is executed.
212	Not possible to carry out Floating origin setting command in the state of Servo OFF.	Carry out Floating origin setting command after making Servo ON status with Servo On command.
221	Not possible to carry out Direct Start command in the state of in operation.	Check if command axis is in operation when Direct Start command is executed.
223	Not possible to carry out Direct Start command in the state of M Code ON.	Execute Direct Start command after turning off the M code On signal with MOF command
224	Not possible to carry out Direct Start command at the absolute coordinate in the origin unsettled state.	Execute Direct Start command after making Home-decided status with Home Return or Floating Origin Setting command
225	Not possible to carry out Direct Start command in the state of Servo OFF.	Carry out Direct Start command after making Servo ON status with Servo On command
226	Shortest distance control can't be executed in Incremental coordinate.	Set the coordinate as Absolute.
227	In Infinite Running Repeat mode, target position of shortest distance control is invalid	In Infinite Running Repeat mode, target position should be 0~ "Infinite Running Repeat position" of Extended parameter.
230	Not possible to carry out continuous operating out Indirect Start command in the state of feed control.	Execute indirect start with setting of feed control for operation control, continuous for operating pattern if it is set as continuous or end.
231	Not possible to carry out Indirect Start command in the state of in operation.	Check if command axis is in operation when Indirect Start command is executed.
233	Not possible to carry out Indirect Start command in the state of M Code ON.	Execute Indirect Start command after turning off the M code On signal with MOF command
234	Not possible to carry out Indirect Start command at the absolute coordinate in the origin unsettled state.	Execute Indirect Start command after making Home-decided status with Home Return or Floating Origin Setting command
235	Not possible to carry out Indirect Start command in the state of Servo OFF.	Carry out Indirect Start command after making Servo ON status with Servo On command
236	Not possible to carry out Continuous operation of Indirect Start at speed control.	When control method is "speed control" and operation pattern is "Continuous", change the operation pattern as "End" or "Keep" and execute Indirect Start command.

Error Code	Error Description	Solutions
237	Step no. of POINT start is limited up to 20.	Set the step no. for POINT start to be less than 20 and greater than 1
238	Not possible to carry out Continuous operation of Indirect Start at S-Curve acceleration / deceleration pattern.	Set the ACC/DEC pattern of extended parameter as "Trapezoid"
239	When main-axis or sub-axis is "Enable" status, Continuous Operation of Indirect Start can't be executed.	Set Infinite Running Repeat of sub-axis or main-axis as "0: Disable" or set the operation pattern as "END" or "KEEP".
240	When main-axis or sub-axis is "Enable" status, Interpolation Operation of Indirect Start can't be executed.	Set Infinite Running Repeat of sub-axis or main-axis as "0: Disable" or set the operation pattern as "END" or "KEEP".
241	Not possible to carry out Linear interpolation Start in the state that main axis of linear interpolation is in operation.	Check if main axis is in operation when Linear interpolation command is executed.
242	Not possible to carry out Linear interpolation Start in the state that subordinate axis of linear interpolation is in operation.	Check if subordinate axis 1 is in operation when Linear interpolation command is executed.
247	Not possible to carry out Linear interpolation Start in the state that M Code signal of main axis of Linear interpolation is ON.	Turn off the M code On signal of main-axis with MOF command and execute the Linear Interpolation operation
248	Not possible to carry out Linear interpolation Start in the state that M Code signal of subordinate axis of Linear interpolation is ON.	Turn off the M code On signal of main-axis with MOF command and execute the Linear Interpolation operation
250	Not possible to carry out positioning operation of absolute coordinate in the state that main axis of Linear interpolation is origin unsettled.	Make the main-axis as home-decided status with Home Return command or Floating Origin setting command
251	Not possible to carry out positioning operation of absolute coordinate in the state that subordinate axis of Linear interpolation is origin unsettled.	Make the sub-axis as home-decided status with Home Return command or Floating Origin setting command
253	In case that main axis and subordinate axis is set wrong in Linear interpolation. (the case that the subordinate axis is not assigned, the case that only one axis is assigned, or the case that no axis is assigned)	Set the more than one axis among axes connected to the network except main-axis for sub-axis setting in main-axis operation data
254	Not possible to carry out the linear interpolation operation because the main axis of Linear interpolation is Servo Off status	Make the main axis as Servo On status with Servo On command.
255	Not possible to carry out the linear interpolation operation because the sub axis of Linear interpolation is Servo Off status	Make the sub axis as Servo On status with Servo On command.
261	Main axis speed of linear interpolation exceeds its speed limit.	Set low for main axis speed so that linear interpolation speed limit would not exceeds.
262	Not possible to insert the circular because the position of 2axis continuous linear interpolation circular insertion are longer than goal position.	Set low for position of 2 axis linear interpolation continuous operating circular insertion from expanded parameter, smaller than goal position.
263	Not possible to insert the circular because two lines of 2axis continuous linear interpolation circular insertion are at the same position.	Set again for goal position or set "0:Not insert circular" for 2 axis linear interpolation continuous operating circular insertion.

Appendix1 Positioning Error Information & Solutions

Error Code	Error Description	Solutions
264	Not possible to insert the circular because the radius of 2axis continuous linear interpolation circular insertion are bigger than 2147483647.	Set again for goal position so those two lines would not be at the same location or set "0:Not insert circular" for 2 axis linear interpolation continuous operating circular insertion then execute linear interpolation.
265	Not possible to insert the circular because the radius of 2axis continuous linear interpolation circular insertion are rarely small or its speed limits are too high.	Make bigger for circular insert position and less for speed limit or set "0:Not insert circular" for 2 axis linear interpolation continuous operating circular insertion then execute linear interpolation.
266	Not possible to insert the circular because the circular of 2axis continuous linear interpolation circular insertion are at the same position from where it is supposedly located.	Set again for goal position so those two lines would not be at the same location or set "0:Not insert circular" for 2 axis linear interpolation continuous operating circular insertion then execute linear interpolation.
267	Interpolation operation can't execute when interpolation sub-axis is the emergency stop state or H/W high(low) limit state.	Execute interpolation command when sub-axis H/W high(low)limit state is off and the emergency stop state is off.
270	Error of radius setting from radius circular interpolation.	Set radius setting from circular interpolation main axis operating data for 80% bigger than its half distance of beginning point to end point.
271	Not possible to carry circular interpolation start in the state that main axis of circular interpolation is in operation.	Check if main axis is in operation when circular interpolation command is executed.
272	Not possible to carry circular interpolation start in the state that subordinate axis of circular interpolation is in operation	Check if subordinate axis is in operation when circular interpolation command is executed.
275	Not possible to carry circular interpolation start in the state that M Code signal of main axis of circular interpolation is ON.	Turn off the M code On signal of the main-axis with MOF command
276	Not possible to carry circular interpolation start in the state that M Code signal of subordinate axis of circular interpolation is ON.	Turn off the M code On signal of the sub-axis with MOF command
277	Not possible to carry positioning operation of absolute coordinate in the state that main axis of circular interpolation is origin unsettled.	Make the main-axis as Home-decided status with Home Return command and Floating origin setting command and then execute the circular interpolation
278	Not possible to carry positioning operation of absolute coordinate in the state that subordinate axis of circular interpolation is origin unsettled	Make the sub-axis as Home-decided status with Home Return command and Floating origin setting command and then execute the circular interpolation
279	Incorrect setting of main axis from circular Interpolation. (Either, unset main axis, incorrect helical interpolation axis, exceeding number of current possible operating axis)	Execute circular interpolation after 1.Set one more operational axis from circular interpolation data except main axis 2. Set one more operate able axis from helical interpolation.
280	Not possible to carry out the Circular interpolation operation because the main axis of Circular interpolation is Servo Off status	Make the main axis as Servo On status with Servo On command.

Error Code	Error Description	Solutions
281	Not possible to carry out the Circular interpolation operation because the sub axis of Circular interpolation is Servo Off status	Make the sub axis as Servo On status with Servo On command.
282	Not possible to carry out degree operation in circular interpolation.	Check if the unit of Basic Parameter of main axis of circular interpolation command is set as degree.
283	Not possible to carry out degree operation in circular interpolation.	Check if the unit of Basic Parameter of subordinate axis of circular interpolation command is set as degree.
284	Not possible to carry out the operation if start point =center point (middle point) or center point (middle point) =end point in circular interpolation.	Check if the center point or middle point is set as the same point as start point or end point in circular interpolation.
285	The start point and end point is Not possible to be same in the middle point mode (Radius mode) of circular interpolation.	Check if circular interpolation method of Common parameter is set as middle point (or Radius) and if the position of start point is not the same as end point.
286	Radius setting error in circular interpolation.	The radius of the circle to carry out circular interpolation operation is up to 2e31 pulse. Check if it is set in order to carry out the circular interpolation more than the size.
287	Not possible to carry out the operation as linear profile comes out of circular interpolation.	Check if circular interpolation method of Common parameter is set as Middle point and the middle point is set to be aligned with start point and end point.
290	Since angular velocity is greater than 90°, correct circle cannot be drawn.	Set operation speed lower than 90° for circular Interpolation angular velocity.
291	Not possible to carry out Synchronous Start command in the state of in operation.	Check if the Error occurred axis is included in Synchronous Start command and if there is no axis in operation when the command is executed.
293	Not possible to carry out Synchronous Start command in the state of M Code ON.	Check if the Error occurred axis is included in Synchronous Start command and if M Code signal is ON when the command is executed. Available to make M Code OFF by MOF command
294	Not possible to carry out Synchronous Start command in case that there is no goal position.	Check if the Error occurred axis is included in Synchronous Start command, and if the goal position of operation data of the step to operate is not the same as the current position for absolute coordinate and is set as "0" for relative coordinate.
295	Not possible to carry out Synchronous Start command in the state that Servo Ready is OFF.	Check if the Error occurred axis is included in Synchronous Start command, and if Driver Ready signal is OFF when the command is executed.
296	In case that Synchronous Start command axis setting is wrong.	Check if only one axis of Synchronous Start command is assigned. The axis assignment address means 0 bit : X axis, 1 bit : Y axis, 2 bit : Z axis and each bit is set as "1" for axis assignment.

Appendix1 Positioning Error Information & Solutions

Error Code	Error Description	Solutions
297	An error occurred from axis of synchronous start operating.	Execute synchronous start after eliminate an error element from error occurred axis.
301	Not possible to carry out Speed/Position control switching command not in the state of in operation.	Check if the axis is 'stop' state when speed/position control switching command is executed.
302	Not possible to carry out Speed/Position control switching command not in the state of speed control.	Check if the axis is 'speed control' state when speed/position control switching command is executed.
303	Not possible to carry out Speed/Position control switching command at subordinate axis of Synchronous Start operation.	Check if the axis is in operation by subordinate axis of Synchronous Start operation when speed/position control switching command is executed.
304	Not possible to carry out Speed/Position control switching command if there is no goal position.	Check if the operation has the goal position when speed /position control switching command is executed.
306	For Position-specified Speed/Position switching command, when Infinite Running Repeat is "Enable", Speed/Position switching coordinate is "Absolute", the value which makes the object go to the opposite direction can't be set.	For position value of Position-specified speed/position switching command, when operation direction is forward, set the positive position value and when operation direction is reverse, set the negative position value.
311	Not possible to carry out Position/Speed control switching command not in the state of in operation.	Check if the axis is 'stop' state when position/speed control switching command is executed.
312	Not possible to carry out Position/Speed control switching command at subordinate axis of Synchronous Start operation.	Check if the axis is in operation by subordinate axis of Synchronous Start operation when position/speed control switching command is executed.
313	Not possible to carry out Position/Speed control switching command in the state of circular interpolation operation.	Check if the axis is in circular interpolation operation when position/speed control switching command is executed.
314	Not possible to carry out Position/Speed control switching command in the state of Linear interpolation operation.	Check if the axis is in linear interpolation operation when position/speed control switching command is executed.
316	Not possible to carry out Position/Speed switching command in the state of decreasing section.	Execute Position/Speed switching command before the decreasing of axis, while in increasing section or regular section.
317	Not possible to carry out Position/Speed switching command when it is not either at the positioning control or inching operation	Execute Position/Speed switching command while the commanding axis is positioning control or inching operation
321	Dec. stop command can't ne executed when axis is not in operation.	Execute Dec. stop command when command axis is in operation

Appendix1 Positioning Error Information & Solutions

Error Code	Error Description	Solutions
322	Not possible to carry out deceleration stop command in the state of Jog operation.	Dec. stop command can't stop JOG operation. For JOG operation stop, use the JOG STOP command.
324	Deceleration time setting from deceleration stop commands are out of range.	The range of deceleration time is between 0 and 2147483647. Execute deceleration command after resetting the value from its range.
331	Not possible to carry out Skip command not in the state of in operation.	Execute the Skip command when command axis is in operation.
332	Not possible to carry out Skip command for subordinate axis of Linear interpolation operation.	Give the Skip command to linear interpolation main-axis.
333	Not possible to carry out Skip command for subordinate axis of Synchronous Start operation.	Check if the axis is in operation by subordinate axis of Synchronous Start operation when Skip command is executed.
335	Not possible to carry out Skip command in the state of Jog operation.	Check if the axis is in Jog operation when Skip command is executed.
336	Not possible to carry out Skip command in the state of Direct Start operation.	Check if the axis is in Direct Start operation when Skip command is executed.
337	Not possible to carry out Skip command in the state of Inching operation.	Check if the axis is in Inching operation when Skip command is executed.
338	Not possible to carry out Skip command for subordinate axis of circular interpolation operation.	Check if the axis is in operation by subordinate axis of circular interpolation operation when Skip command is executed.
339	Skip operation command can't be executed during torque control.	Skip operation command doesn't work in the axis under torque control.
341	Not possible to carry out Synchronous Start by Position command in the state of in operation.	Check if the axis is in operation when Synchronous Start by Position command is executed.
343	Not possible to carry out Synchronous Start by Position command in the state of M Code ON.	Check if the M Code signal of the axis is ON when Synchronous Start by Position command is executed. Available to make M Code OFF by MOF command.
344	Not possible to carry out Synchronous Start by Position command at the absolute coordinate in the state of origin unsettled.	Not available to carry out absolute coordinate operation in the origin unsettled state. Check the coordinate of step to operate and the current origin determination state. Available to carry out absolute coordinate operation after origin determination by Homing command or floating origin setting command.
345	Not possible to carry out Synchronous Start by Position command in the state that Servo Ready is OFF.	Check if Driver Ready signal of the axis is OFF when Synchronous Start by Position command is executed.
346	Not possible to carry out Synchronous Start by Position command in the state that the origin of main axis is not settled.	Check if main axis is in the origin unsettled state when Synchronous Start command is executed.

Appendix1 Positioning Error Information & Solutions

Error Code	Error Description	Solutions
347	There is error in setting main axis/subordinate axis of Synchronous Start by Position command.	Set the main axis of Synchronous Start command with one among axes connected to the network other than command axis and encoders. For main axis setting, 1(1-axis)~8(8-axis), 9(Encoder1), 10(Encoder2) are available.
350	Not possible to carry out Synchronous Start when main-axis is in operation	Execute Synchronous Start when main-axis is not in operation.
351	Not possible to carry out Synchronous Start by Speed command in the state of in operation.	Check if the axis is in operation when Synchronous Start by Speed command is executed.
353	Not possible to carry out Synchronous Start by Speed command in the state of M Code ON.	Check if the M Code signal of the axis is ON when Synchronous Start by Speed command is executed. Available to make M Code OFF by XMOF command.
354	Not possible to carry out Synchronous Start by Speed command in the state that Servo Ready is OFF.	Check if Driver Ready signal of the axis is OFF when Synchronous Start by speed command is executed.
355	There is error in setting main axis/subordinate axis of Synchronous Start by Speed command.	Check if main axis of Synchronous Start by Speed command is set as the same as command axis. Main axis is set by writing 0(X axis),1(Y axis),2(Z axis) to the setting address.
356	There is error in setting main/sub axis settings.	Main axis ratio of Speed Synchronous command can't be 0. set the value of -32768 ~ 32767 except 0
357	The speed of Synchronous Start by Speed command cannot exceeds its speed limit.	Set low for main axis ratio/second axis ratio values so The value would not exceed its limitation.
361	Not possible to carry out Position Override command not in the state of in operation (Busy).	Check if the axis is 'stop' state when Position Override command is executed.
362	Not possible to carry out Position Override command not in the state of in dwell.	Check if the axis is in dwell when Position Override command is executed..
363	Not possible to carry out Position Override command not in the state of positioning operation.	Check if the axis is in operation by position control when Position Override command is executed.
364	Not possible to carry out Position Override command for the axis of Linear interpolation operation.	Check if the axis is in Linear interpolation operation when Position Override command is executed.
365	Not possible to carry out Position Override command for the axis of circular interpolation operation.	Check if the axis is in circular interpolation operation when Position Override command is executed.
366	Not possible to carry out Position Override command for the subordinate axis of Synchronous operation.	Check if the axis is in operation by subordinate axis of Synchronous Start operation when Position Override command is executed.
371	Not possible to carry out Speed Override command not in the state of in operation (Busy).	Check if the axis is 'stop' state when Speed Override is executed.
372	Exceeds the range of speed override value.	Speed value of Speed Override command should be less than or equal to max. speed set in Basic Parameter. Check the speed value.

Error Code	Error Description	Solutions
373	Not possible to carry out Speed Override command for the subordinate axis of Linear interpolation operation.	Check if the axis is in operation by subordinate axis of Linear interpolation operation when Speed Override command is executed.
374	Not possible to carry out Speed Override command for the axis of circular interpolation operation.	Check if the axis is in operation by subordinate axis of circular interpolation operation when Speed Override command is executed.
375	Not possible to carry out Speed Override command for the subordinate axis of Synchronous operation.	Check if the axis is in operation by subordinate axis of Synchronous Start operation when Speed Override command is executed.
377	Not possible to carry out Speed Override command in the deceleration section.	Check if the axis is in the state of deceleration stop when Speed Override command is executed.
378	Not possible to carry out Speed Override command in S-curve acceleration/deceleration pattern.	Check if the acceleration/deceleration pattern of Extended Parameter of command axis is set as S-Curve.
381	Not possible to carry out Random position speed override command not in the state of in operation.	Check if the axis is 'stop' state when Random position speed override command is executed.
382	Not possible to carry out Random position speed override command not in positioning operation.	Check if the axis is in speed control operation when Random position speed override command is executed.
383	Exceeds the speed override value range of Random position speed override command.	Speed value of Random position speed override command should be less than or equal to max. speed set in Basic Parameter. Check the speed value.
384	Not possible to carry out Random position speed override command for the subordinate axis of Linear interpolation operation.	Check if the axis is in operation by subordinate axis of Linear interpolation operation when Random position speed override command is executed.
385	Not possible to carry out Random position speed override command for the axis of circular interpolation operation.	Check if the axis is in circular interpolation operation when Speed Override command is executed.
386	Not possible to carry out Random position speed override command for the subordinate axis of Synchronous operation.	Check if the axis is in operation by subordinate axis of Synchronous Start operation when Speed Override command is executed.
389	Not possible to carry out Random position speed override command in S-Curve acceleration / deceleration pattern.	Check if the acceleration/deceleration pattern of Extended Parameter of command axis is set as S-Curve
390	Not possible to carry out Continuous operation command in S-Curve acceleration/deceleration pattern.	Check if the acceleration/deceleration pattern of Extended Parameter of command axis is set as S-Curve
391	Not possible to carry out Continuous operation command not in the state of in operation.	Check if the axis is 'stop' state when Continuous operation command is executed.
392	Not possible to carry out Continuous operation command not in the state of in dwell.	Check if the axis is in dwell when Continuous operation command is executed.
393	Not possible to carry out Continuous operation command not in the settled of positioning operation.	Check if the axis is in speed control operation when Continuous operation command is executed.

Appendix1 Positioning Error Information & Solutions

Error Code	Error Description	Solutions
394	Speed data value of Continuous operation command exceeds the allowable range.	Speed value of Continuous operation command should be less than or equal to max. speed set in Basic Parameter. Check the speed value.
395	Not possible to carry out Continuous operation command for the subordinate axis of Linear interpolation operation.	Check if the axis is in operation by subordinate axis of Linear interpolation operation when Continuous operation command is executed.
396	Not possible to carry out Continuous operation command for the axis of circular interpolation operation axis.	Check if the axis is in circular interpolation operation when Continuous operation command is executed.
397	Not possible to carry out Continuous operation command for the subordinate axis of Synchronous operation.	Check if the axis is in operation by subordinate axis of Synchronous Start operation when Continuous operation command is executed.
399	Not possible to carry out Continuous operation command at the last step of Operation data.	Check if the axis is in operation of 400 th step when Continuous operation command is executed.
400	Not possible to carry out Continuous operation command in the state of Direct Start operation.	Check if the axis is in operation by Direct Start command that Continuous operation command is executed.
401	Not possible to carry out Inching command in the state of in operation.	Check if the axis is in operation when Inching command is executed.
403	Not possible to carry out Inching command in the state that Drive Ready is OFF.	Check if Drive Ready signal of the axis is OFF when Inching command is executed.
411	Not possible to carry out Jog Start command in the state of in operation.	Check if the axis is in operation when Jog Start command is executed.
413	Not possible to carry out Jog Start command in the state that Servo Ready is OFF.	Check if Driver Ready signal of the axis is OFF when Jog Start command is executed.
431	Not possible to carry out Return to the Position before Manual Operation in the state of in operation.	Check if the axis is in operation when Return to the position before manual operation command is executed .
434	Not possible to carry out Return to the Position before Manual Operation in the state that Drive Ready is OFF.	Check if Driver Ready signal of the axis is ON when Return to the position before manual operation command is executed.
441	Not possible to carry out Start step no. Change/Repeat Operation Start step no. assignment command in the state of in operation.	Check if the axis is in operation when Start step no. change /repeat command is executed.
442	Exceeds the step assignment range of Start step no. Change/Repeat Operation Start step no. assignment command.	Check if the setting step value of Start step no. change command or repeat operation start step no. assignment command is greater than or equal to 1 and less than or equal to 400.
451	Not possible to carry out Current Position Preset command in the state of in operation.	Check if the axis is in operation when Current position preset command is executed.
452	Not possible to set the auxiliary position data value out of range of software high/low limit while Current Position Preset command is executed.	Check if the position value of current position preset command is within the range of soft high /low limit set in Extended Parameter.
462	Not possible to carry out Teaching Array command for the data over 16.	Check if the data no. of Teaching Array command is set in the range that is greater than or equal to 1 and less than or equal to 16.

Error Code	Error Description	Solutions
463	Not possible to carry out Speed Teaching command in the state of in operation.	Check if the axis is in operation when Speed teaching command is executed.
465	Error from step number appointing which are about to execute teaching operation.	Make sure step for teaching operation is smaller than 400 or same as 400.
466	Teaching list error for multi teaching command.	Execute teaching command after set teaching data list as 0:position or 1:speed
467	Teaching method error for multi teaching command.	Execute teaching command after set teaching method as 0:position or 1:speed
471	Parameter teaching command cannot be Executed while its operating.	Check if the axis was operating when parameter teaching commands are executing
473	Set data cannot be teaching.	Execute teaching command after setting right value for parameter teaching data or operating data teaching list.
474	Parameter/Operation data saving commands cannot be done while the axis is operating.	Check if the axis is operating when Parameter/Operation data saving commands are operating. Execute Parameter/Operation command when any axis are not operating.
475	Error of value for teaching data is out of range.	Execute teaching command after setting value of parameter teaching or operating data teaching data among its set range.
476	Error of value for teaching method is out of range.	Execute teaching command after setting value of parameter teaching or operating data teaching data for 1(RAM teaching) or 2(ROM teaching).
477	There may be damage to parameter/operation data because power turns off when saving parameter/operation data.	Write parameter/operation data with "Write Project" command in the XG-PM.
478	There may be damage to CAM data because power turns off when saving parameter/operation data.	Write CAM data with "Write Project" command in the XG-PM.
481	Error of internal emergency stop	Eliminate reason of emergency stop and execute XCLR command to delete the error.
492	Hard Upper Error	Be out of limited external upper signal range by using counter direct jog command. Then execute XCLR command to delete the error.
493	Hard Lower Error	Be out of limited external lower signal range by using direct jog command. Then execute XCLR command to delete the error.
501	Soft Upper Error	Be out of limited soft upper range by using counter direct jog command. Then execute XCLR command to delete the error.
502	Soft Lower Error	Be out of limited soft upper range by using direct jog command. Then execute XCLR command to delete the error.
511	Inappropriate command	Check the commands are appropriate. Look up the references for COMMANDS.
512	Step number of support data is out of range.	Commands set for bigger than 400. Set it Between 1 and 400.
521	Can't execute the command because of servo driver error during operation	Remove the servo error factor and clear the servo error with Servo Error Reset command.

Appendix1 Positioning Error Information & Solutions

Error Code	Error Description	Solutions
522	The command cannot be done when the signal of Drive Ready is OFF during the operation.	Execute again once Drive Ready is ON.
523	Not possible to carry out command because "Quick stop" function is activated during operation	Check if "Quick Stop" function is activated by EMG stop input and etc.
532	Preset command cannot be done because of the axis which using encoder1 as a main axis	Execute Encoder preset when the encoder1 using axis is not operating
534	The position of Encoder preset exceeds from Max or Min value of encoder.1	Execute Encoder1 preset command after set the value of encoder position preset as bigger than Min value and smaller than Max value.
541	Ellipse interpolation cannot be operated while main axis of circular interpolation is operating.	Execute the Ellipse interpolation command when main axis is not operating.
542	Ellipse interpolation cannot be operated while support axis of circular interpolation is operating.	Execute the circular interpolation command when subordinate axis is not operating
543	Ellipse interpolation start cannot be operated when M code from main axis circular interpolation is "ON."	Execute Ellipse interpolation command after set M code from main axis Ellipse interpolation is "OFF" with MOF command.
544	Ellipse interpolation start cannot be operated when M code from subordinate axis circular interpolation is "ON."	Execute Ellipse interpolation command after set M code from subordinate axis Ellipse interpolation is "OFF" with XMOF command.
545	Not possible to carry out absolute coordinate positioning operation in the state that the origin of main axis is not settled.	Execute Ellipse interpolation command after set main axis as a state of being origin with homing command or floating origin setting.
546	Not possible to carry out absolute coordinate positioning operation in the state that the origin of sub axis is not settled.	Execute Ellipse interpolation command after Set sub axis as a state of being origin with homing command or floating origin setting.
547	Incorrect setting for main and subordinate axis from Ellipse interpolation.(Unset for main/subordinate axis Set as Helical interpolation Exceed number of possible current operating Axis.)	Execute Ellipse interpolation after set a axis From subordinate axis setting beside its main axis and unset Helical interpolation.
548	Ellipse interpolation cannot be operated with middle point setting and radius setting.	Ellipse interpolation only can operate in center point setting. Execute Ellipse interpolation after changing operating data Ellipse interpolation mode for center point setting.
549	Cannot be operated when Drive Ready of Ellipse interpolation main axis is "OFF."	Execute Ellipse interpolation command after Drive Ready is "ON" of main axis.
550	Cannot be operated when Drive Ready of Ellipse interpolation subordinate axis is "OFF."	Execute Ellipse interpolation command after Drive Ready is "ON" of subordinate axis.
551	Cannot be operated when unit of Ellipse interpolation main axis is "degree."	Execute Ellipse interpolation command after Basic parameter unit is "degree" of main axis.
552	Cannot be operated when unit of Ellipse interpolation subordinate axis is "degree."	Execute Ellipse interpolation command after basic parameter unit is "degree" of subordinate axis.
553	Cannot be operated when three parameters of Ellipse interpolation are same. (start point=main point=end point)	Execute Ellipse interpolation command after set those parameters differently. (start point, main point, end point)

Error Code	Error Description	Solutions
554	Radius setting error from Ellipse interpolation.	The range of possible execution for Ellipse Interpolation is between 0 and 2147483647. Set radius of circle from its range, smaller than 2147483647pulse.
555	Exact circle cannot be draw because of degree of Ellipse interpolation is bigger than 90°	Set lower for operation speed so that degree of Ellipse interpolation is smaller than 90°
556	Continuous operation cannot be done for Ellipse interpolation.	Execute Ellipse interpolation after terminate operation step of circular interpolation.
557	Ellipse interpolation only can be operated when control setting is circular interpolation.	Execute Ellipse interpolation after change control setting for drive step of Ellipse interpolation to circular interpolation.
558	Operation cannot be executed when beginning point and end point of ellipse interpolation are not same.	Execute Ellipse interpolation after set the goal Position of ellipse interpolation operating step Same as current position.
559	Operation cannot be executed when operating degree of ellipse interpolation is "0."	Set the value of operating degree for ellipse interpolation, larger than "0."(1~65535)
561	Position/Torque switching command can't be executed when axis is not in operation	Execute Position/Torque switching command when command axis is not in operation.
562	Position/Torque switching command can't be executed at the sub axis of synchronous operation	Position/Torque switching command doesn't work at the sub axis of synchronous operation
563	Position/Torque switching command can't be executed under circular (ellipse) interpolation operation.	Position/Torque switching command doesn't work at the axis under circular (ellipse) interpolation operation.
564	Position/Torque switching command can't be executed under linear interpolation operation.	Position/Torque switching command doesn't work at the axis under linear interpolation operation.
565	Not possible to carry out torque control because servo driver doesn't support torque control	Unable to carry out torque control in that servo driver
571	Operation cannot be executed because of error from sub-coordinate axis of main axis by current axis.	Check the error from subordinate axis of main axis by current axis whether it is occurred during the operation of current axis.
572	Operation cannot be executed because of error from sub coordinate axis of main axis by interpolated axis.	Check the error from subordinate axis of main axis by current axis whether it is occurred during the operation of interpolated axis.
582	In infinite running repeat mode, In case of shortest distance positioning control, target position is invalid.	In infinite running repeat mode, In case of shortest distance positioning control, target position should be 0~ "infinite running repeat position" of extended parameter.

Appendix1 Positioning Error Information & Solutions

Error Code	Error Description	Solutions
591	Not possible to carry our “Servo parameter write” command while operating	Execute “Servo parameter write” when command axis is not operating.
592	Data such as servo parameter index, subindex are out of range.	Don't let data setting value out of range
593	“Abort” arises during “servo parameter write” command	Check if parameter is writable or parameter number and setting data is within range. Sometimes you can't write parameter according to servo driver status.
594	There is no response of the servo driver on “servo parameter write” command.	Check if servo driver is normal or not.
595	Unable to carry out “Servo parameter EEPROM save” command while servo is on.	Execute “Servo parameter EEPROM save” command after making the servo “off” status with “Servo off” command
596	“Abort” arises during “servo parameter EEPROM write” command	Check the status of the servo driver. In particular status, “Servo parameter EEPROM save” command can't be executed.
597	There is no response of the servo driver on “servo parameter EEPROM save” command.	Check if servo driver is normal or not.
598	The axis for “Servo parameter EEPROM save” is not connected now.	It can execute “Servo parameter EEPROM save” command only for currently connected axis.
599	Unable to carry out other commands during “Servo parameter write” or “Servo parameter EEPRO save”	Execute other commands after completing “Servo parameter write” or “Servo parameter EEPROM save”.
600	“Abort” arises during “servo parameter read” command	Check if parameter is readable or parameter number and setting data is within range. Sometimes you can't read parameter according to servo driver status.
601	There is no response of the servo driver on “servo parameter read” command.	Check if servo driver is normal or not.
602	It is not possible to execute the “Servo parameter read/write” or “Servo parameter save” command in the state that servo parameter read command is executing.	Execute command when servo parameter read command is completed.

Appendix1 Positioning Error Information & Solutions

Error Code	Error Description	Solutions
701	Not possible to carry out CAM command in the state of in operation.	Execute CAM command when main axis is not operating.
702	Not possible to carry out CAM command in the state of M Code ON	Execute CAM command after set M Code OFF from commanding axis with MOF.
703	Not possible to carry out CAM command in the state that servo is OFF.	Execute CAM command when Servo On signal is "ON."
704	Error of setting main/subordinate axis from CAM command.	Set main axis for CAM command as other axis besides its command axis from connecting axis. Set parameters are 1axis through 8axis.
706	Error of CAM block setting from CAM command.	Execute CAM command after set a CAM block from CAM command as bigger than 1 and smaller than 8.
707	Error for CAM data of appointed block from CAM command.	Execute CAM command after set right data for appointed block from CAM command.
708	The speed of subordinate axis from CAM command cannot exceed its speed limit.	Set lower speed for main axis so that speed of subordinate axis from CAM data which is calculated by subordinate position would not exceed its speed limit.
709	For CAM command, in case main axis is encoder, main axis unit of CAM data should be pulse.	When you set the main axis of CAM data as encoder, set the unit of main axis of CAM block as pulse.
710	Movement position per control cycle is out of main axis range of CAM data because high speed of main axis of CAM command.	Operate with lower speed of main axis.
711	Data area setting value (block size and no. of block) of Variable Data Read/Write command is out of range.	Set the block size and no. of block for [block size X no. of block] to be 1~128.
712	Variable Data Write command can't be executed during operation.	Check whether any axis is under operation when executing the Variable Data Write command
713	Block area of Variable Data Write command is overlapped so Writing is unavailable.	In case the number of block is more than 2, set the block set to be larger than block size. (Or set the block size to be smaller than block offset)
721	Restart command can't be executed after operate the restart unavailable command, just like circular interpolation etc.	Check whether execute the restart unavailable command before execute restart command.
722	Restart command can't be executed during the operation.	Execute restart command when main axis is not operating.
732	Synchronous torque command can be executed only in case of main axis is not running or torque control is running.	Please execute the command, in case of main axis is not running or torque control is running.
733	Synchronous torque command torque and speed ratio can't set to zero.	Please set the synchronous torque command torque and speed ratio greater than zero.
734	Synchronous torque command main or sub axis setting has an error.	Please set the main axis setting of synchronous torque command to other than command axis. Main axis setting range is 1 to 8.
735	Not possible to carry out synchronous torque command in the state that servo is OFF.	Execute synchronous torque command when Servo On signal is "ON."

Appendix1 Positioning Error Information & Solutions

Error Code	Error Description	Solutions
741	Not possible to execute torque control command in the state of in operation except torque control in operation	Execute torque control command when main axis is not operating.
742	Not possible to carry out torque control command in the state of M Code ON	Execute torque control command after set M Code OFF from commanding axis with MOF.
743	Not possible to carry out torque control command in the state that servo is OFF.	Execute torque control command when Servo On signal is "ON."
751	"Latch Configuration command" can't be executed because servo drive doesn't support "Latch(Touch probe)" function.	Corresponding servo drive can't be execute "Latch Configuration command".
752	Servo Drive does not support TouchProbe1 Rising Edge	Set TouchProbe1 Rising Edge PDO from Servo.
753	Servo Drive does not support TouchProbe2 Rising Edge	Set TouchProbe2 Rising Edge PDO from Servo.
754	Servo Drive does not support TouchProbe1 Falling Edge	Set TouchProbe1 Falling Edge PDO from Servo.
755	Servo Drive does not support TouchProbe2 Falling Edge	Set TouchProbe2 Falling Edge PDO from Servo.
756	TouchProbe Signal Value is out of the rage	Set TouchProbe Signal Value in the rage.
761	"CAM Restart" can be executed only while main axis is operating.	"CAM operating" command should be executed only when the main axis is being stopped and the status is STOP.
762	"CAM Restart" operation can't be executed when the main axis is operating while the sub(execute) axis move to designated synchronous position.	Please be assure main axis isn't executed while the sub(execute) axis move to designated synchronous position after "CAM Restart" operation.
771	"Phasing correction command" can't be executed if the sub(command) axis isn't configured as "synchronous control"(CAM, Speed Sync.).	Please execute "Phasing correction" command while the sub(command) axis is operating.
772	There exists configuration error for main axis of "Phasing correction command".	Please execute "Phasing correction" command after configuring the main axis as an actual main axis of synchronous operation.

Error Code	Error Description	Solutions
773	Position expressions are for “Phasing correction amount” is out of range.	Please execute command after set in pulse units for “Phasing correction” within DWORD(-2147483648~ 2147483647).
774	“Phasing correction speed value” is out of range.	Please execute command after set “Phasing correction speed” above 1 and range below of “speed limitation” for the main axis.
775	“Phasing correction speed value” is out of range.	Please execute command after set “Phasing correction speed” above 0 and range below of “speed limitation” for the main axis.
776	“Phasing correction speed value” is out of range.	Please execute command after set “Phasing correction speed” above 0 and range below of “speed limitation” for the main axis.
791	Sub Axis is over the Speed limit in Speed Sync.	In Syn.Speed Designating Sync.Position, Set Main and Sub axis Sync. Position lager.
792	Sub Axis is unavailable to catch Acc, Dec time, and Speed.	In Syn.Speed Designating Sync.Position, Set Main and Sub axis Sync. Position lager.
801	Command axis is the axis which is not connected to the current network.	Check whether the command axis is the axis connected to current network. Give the command to the axis connected to current network.
811	Commands that have been run previously may not be able to perform additional commands that are not processed by the module.	Make sure that there is a command that was executed previously, please run the additional command after the command has been processed by the module.
821	This command cannot be used on a virtual axis,	Axis command cannot execute the command to the virtual axis.

App1.8. Error information related with communication

Error Code	Error Description	Solutions
5001	There is no servo connected to the current network.	Check whether power of the servo connected to the network is on, or whether communication cable between the module and first servo driver connected to the network is installed normally.
5002	Servo Communication Initialization Error	Check whether communication cable is installed normally, or whether communication cable is exposed to the noise.
5003	Servo Communication Initialization Error	Check whether communication cable is installed normally, or whether communication cable is exposed to the noise.
5004	Servo Communication Initialization Error	Check whether communication cable is installed normally, or whether communication cable is exposed to the noise.
5005	Servo Communication Initialization Error	Check whether communication cable is installed normally, or whether communication cable is exposed to the noise.

Appendix1 Positioning Error Information & Solutions

Error Code	Error Description	Solutions
5008	Fixed Period Communication Error	Check whether servo power is off, or whether communication cable is installed normally, or whether communication cable is exposed to the noise.
5009	Communication Setting Error	Check whether servo power is off, or whether communication cable is installed normally, or whether communication cable is exposed to the noise.
5020	There is no setting information on the servo driver connected to current network.	After adding the servo driver to the current network and writing network parameter, execute "Connect to all servos" command.
5021	There is no setting data in the network parameter	After setting the network parameter and writing network parameter, execute "Connect to all servos" command.
5022	Servo driver information set in the network parameter is different with that in the actual connection.	Set the servo driver information set in the network parameter to be same
5023	Unable to switch operation mode of the servo driver to Position control mode	Check if servo driver is normal
5024	Unable to switch operation mode of the servo driver to Home return mode	Check if servo driver is normal
5025	Unable to switch operation mode of the servo driver to Torque control mode	Check if servo driver is normal
5026	Unable to compete "Servo on" because it is impossible to change the servo driver to "Switched on" status	Check the status of the servo driver In particular status, "Servo on" command can't be executed.
5027	Unable to compete "Servo on" because it is impossible to change the servo driver to "Operation enabled " status	Check the status of the servo driver In particular status, "Servo on" command can't be executed.
5028	Unable to compete "Servo on" because "Quick stop" function is activated.	Check if "Quick stop" function is activated because of EMG stop and etc. In particular status, "Servo on" command can't be executed.
5031	Real-axis is set as a virtual-axis.	Real-axis is set as a virtual-axis. Please check the basic parameters of the virtual-axis setting.

App1.9. H/W error information

Error Code	Error Description	Solutions
12	Module H/W is abnormal(FPGA) so can't run the module in normal operation.	If this situation repeatedly occurred after reset the power, please request the A/S to us.
13	Module H/W is abnormal(FLASH and Backup RAM) so can't run the module in normal operation.	If this situation repeatedly occurred after reset the power, please request the A/S to us.

Appendix2. Module Internal Memory Address of “Read/Write Variable Data” command

App2.1. Parameter Memory Address

	1axis		2axis		3axis		4axis		5axis		6axis		7axis		8axis		Contents
	DEC	HEX	DEC	HEX	DEC	HEX	DEC	HEX	DEC	HEX	DEC	HEX	DEC	HEX	DEC	HEX	
Basic Parameter	0	0	68	44	136	88	204	CC	272	110	340	154	408	198	476	1DC	Speed limit (Low)
	1	1	69	45	137	89	205	CD	273	111	341	155	409	199	477	1DD	Speed limit (High)
	2	2	70	46	138	8A	206	CE	274	112	342	156	410	19A	478	1DE	Acc. time 1 (Low)
	3	3	71	47	139	8B	207	CF	275	113	343	157	411	19B	479	1DF	Acc. time 1 (High)
	4	4	72	48	140	8C	208	D0	276	114	344	158	412	19C	480	1E0	Acc. time 2 (Low)
	5	5	73	49	141	8D	209	D1	277	115	345	159	413	19D	481	1E1	Acc. time 2 (High)
	6	6	74	4A	142	8E	210	D2	278	116	346	15A	414	19E	482	1E2	Acc. time 3 (Low)
	7	7	75	4B	143	8F	211	D3	279	117	347	15B	415	19F	483	1E3	Acc. time 3 (High)
	8	8	76	4C	144	90	212	D4	280	118	348	15C	416	1A0	484	1E4	Acc. time 4 (Low)
	9	9	77	4D	145	91	213	D5	281	119	349	15D	417	1A1	485	1E5	Acc. time 4 (High)
	10	A	78	4E	146	92	214	D6	282	11A	350	15E	418	1A2	486	1E6	Dec. time 1 (Low)
	11	B	79	4F	147	93	215	D7	283	11B	351	15F	419	1A3	487	1E7	Dec. time 1 (High)
	12	C	80	50	148	94	216	D8	284	11C	352	160	420	1A4	488	1E8	Dec. time 2 (Low)
	13	D	81	51	149	95	217	D9	285	11D	353	161	421	1A5	489	1E9	Dec. time 2 (High)
	14	E	82	52	150	96	218	DA	286	11E	354	162	422	1A6	490	1EA	Dec. time 3 (Low)
	15	F	83	53	151	97	219	DB	287	11F	355	163	423	1A7	491	1EB	Dec. time 3 (High)
	16	10	84	54	152	98	220	DC	288	120	356	164	424	1A8	492	1EC	Dec. time 4 (Low)
	17	11	85	55	153	99	221	DD	289	121	357	165	425	1A9	493	1ED	Dec. time 4 (High)
	18	12	86	56	154	9A	222	DE	290	122	358	166	426	1AA	494	1EE	Dec. time for EMG stop (Low)
	19	13	87	57	155	9B	223	DF	291	123	359	167	427	1AB	495	1EF	Dec. time for EMG stop (High)
	20	14	88	58	156	9C	224	E0	292	124	360	168	428	1AC	496	1F0	Pulse per rotation (Low)
	21	15	89	59	157	9D	225	E1	293	125	361	169	429	1AD	497	1F1	Pulse per rotation (High)
	22	16	90	5A	158	9E	226	E2	294	126	362	16A	430	1AE	498	1F2	Distance per rotation (Low)
	23	17	91	5B	159	9F	227	E3	295	127	363	16B	431	1AF	499	1F3	Distance per rotation (High)
	24	18	92	5C	160	A0	228	E4	296	128	364	16C	432	1B0	500	1F4	CONTROL WORD1
25	19	93	5D	161	A1	229	E5	297	129	365	16D	433	1B1	501	1F5	CONTROL WORD2	

Appendix2 Module Internal Memory Address of 'Read/Write Variable Data' Command

	1axis		2axis		3axis		4axis		5axis		6axis		7axis		8axis		Contents
	DEC	HEX	DEC	HEX	DEC	HEX	DEC	HEX	DEC	HEX	DEC	HEX	DEC	HEX	DEC	HEX	
Extended parameter	26	1A	94	5E	162	A2	230	E6	298	12A	366	16E	434	1B2	502	1F6	S/W upper limit (Low)
	27	1B	95	5F	163	A3	231	E7	299	12B	367	16F	435	1B3	503	1F7	S/W upper limit (High)
	28	1C	96	60	164	A4	232	E8	300	12C	368	170	436	1B4	504	1F8	S/W lower limit (Low)
	29	1D	97	61	165	A5	233	E9	301	12D	369	171	437	1B5	505	1F9	S/W lower limit (High)
	30	1E	98	62	166	A6	234	EA	302	12E	370	172	438	1B6	506	1FA	
	31	1F	99	63	167	A7	235	EB	303	12F	371	173	439	1B7	507	1FB	Position completion time
	32	20	100	64	168	A8	236	EC	304	130	372	174	440	1B8	508	1FC	S-curve ratio
	33	21	101	65	169	A9	237	ED	305	131	373	175	441	1B9	509	1FD	CONTROL WORD
	34	22	102	66	170	AA	238	EE	306	132	374	176	442	1BA	510	1FE	In-position width (Low)
	35	23	103	67	171	AB	239	EF	307	133	375	177	443	1BB	511	1FF	In-position width (High)
	36	24	104	68	172	AC	240	F0	308	134	376	178	444	1BC	512	200	Arc insertion position (Low)
	37	25	105	69	173	AD	241	F1	309	135	377	179	445	1BD	513	201	Arc insertion position (High)
	38	26	106	6A	174	AE	242	F2	310	136	378	17A	446	1BE	514	202	Infinite Running Repeat position (Low)
39	27	107	6B	175	AF	243	F3	311	137	379	17B	447	1BF	515	203	Infinite Running Repeat position (High)	
Manual operation parameter	40	28	108	6C	176	B0	244	F4	312	138	380	17C	448	1C0	516	204	JOG high speed (Low)
	41	29	109	6D	177	B1	245	F5	313	139	381	17D	449	1C1	517	205	JOG high speed (High)
	42	2A	110	6E	178	B2	246	F6	314	13A	382	17E	450	1C2	518	206	JOG low speed (Low)
	43	2B	111	6F	179	B3	247	F7	315	13B	383	17F	451	1C3	519	207	JOG low speed (High)
	44	2C	112	70	180	B4	248	F8	316	13C	384	180	452	1C4	520	208	JOG acc. time (Low)
	45	2D	113	71	181	B5	249	F9	317	13D	385	181	453	1C5	521	209	JOG acc. time (High)
	46	2E	114	72	182	B6	250	FA	318	13E	386	182	454	1C6	522	20A	JOG dec. time (Low)
	47	2F	115	73	183	B7	251	FB	319	13F	387	183	455	1C7	523	20B	JOG dec. time (High)
	48	30	116	74	184	B8	252	FC	320	140	388	184	456	1C8	524	20C	Inching speed
	49	31	117	75	185	B9	253	FD	321	141	389	185	457	1C9	525	20D	-

Appendix2 Module Internal Memory Address of 'Read/Write Variable Data' Command

	50	32	118	76	186	BA	254	FE	322	142	390	186	458	1CA	526	20E	
	51	33	119	77	187	BB	255	FF	323	143	391	187	459	1CB	527	20F	
	52	34	120	78	188	BC	256	100	324	144	392	188	460	1CC	528	210	
	53	35	121	79	189	BD	257	101	325	145	393	189	461	1CD	529	211	
	54	36	122	7A	190	BE	258	102	326	146	394	18A	462	1CE	530	212	
	55	37	123	7B	191	BF	259	103	327	147	395	18B	463	1CF	531	213	
	56	38	124	7C	192	C0	260	104	328	148	396	18C	464	1D0	532	214	
	57	39	125	7D	193	C1	261	105	329	149	397	18D	465	1D1	533	215	
	58	3A	126	7E	194	C2	262	106	330	14A	398	18E	466	1D2	534	216	
	59	3B	127	7F	195	C3	263	107	331	14B	399	18F	467	1D3	535	217	
	60	3C	128	80	196	C4	264	108	332	14C	400	190	468	1D4	536	218	
	61	3D	129	81	197	C5	265	109	333	14D	401	191	469	1D5	537	219	
	62	3E	130	82	198	C6	266	10A	334	14E	402	192	470	1D6	538	21A	
	63	3F	131	83	199	C7	267	10B	335	14F	403	193	471	1D7	539	21B	
	64	40	132	84	200	C8	268	10C	336	150	404	194	472	1D8	540	21C	
	65	41	133	85	201	C9	269	10D	337	151	405	195	473	1D9	541	21D	
	66	42	134	86	202	CA	270	10E	338	152	406	196	474	1DA	542	21E	
	67	43	135	87	203	CB	271	10F	339	153	407	197	475	1DB	543	21F	
Common parameter														544	220	CONTROL WORD	
														545	221	-	
														546	222	Encoder 1 max. value (Low)	
														547	223	Encoder 1 max. value (High)	
														548	224	Encoder 1 min. value (Low)	
														549	225	Encoder 1 min. value (High)	
														550	226	Encoder 2 max. value (Low)	
														551	227	Encoder 2 max. value (High)	
														552	228	Encoder 2 min. value (Low)	
													553	229	Encoder 2 min. value (High)		

(1) Basic parameter Control Word

Control Word1

Bit position	Contents
Axis type (bit 0 ~ 1)	0: Real 1: Virtual
Unit (bit 2 ~ 3)	0: pulse, 1: mm, 2: inch, 3: degree
Unit multiplier (bit 4 ~ 5)	0: x1, 1: x10, 2: x100, 3: x1000
Speed command unit (bit 6)	0: Unit/Time, 1: rpm
Encoder selection * (bit 7)	0: incremental encoder, 1: absolute encoder

Control Word2

Bit position	Contents
User defined position display magnification (bit 0 ~ 2)	0 ~ 7
User defined position speed magnification (bit 3 ~ 5)	0 ~ 7
Torque command unit (bit 6)	0: 1%, 1: 0.1%

(2) Extended parameter Control Word

Bit position	Contents
CAM restart (bit 0)	0: Disable, 1: Enable
Acc./Dec. pattern (bit 1)	0: Trapezoid,, 1: S-curve
M code mode (bit 2 ~ 3)	0: None, 1: With, 2: After
Interpolation speed selection (bit 4)	0: main-axis speed, 1: synthetic speed
Soft limit detect (bit 5)	0: Don't detect, 1: Detect
External command selection (bit 6)	0: External speed/position control switching, 1: External stop command
External command (bit 7)	0: Disable, 1: Enable
Position complete condition (bit 10 ~ 11)	0: Dwell time, 1: In-position, 2: Dwell time AND In-position, 3: Dwell time OR In-position
Infinite running repeat (bit 12)	0: Disable, 1: Enable
Int. continuous opr. type (bit 13)	0: Pass target pos, 1: Pass near pos
Arc insertion (bit 14)	0: Don't insert, 1: Insert arc cont.
Pos-specified speed override coordinate (bit 15)	0: ABS, 1: INC

(3) Common parameter Control Word

Bit position	Contents
Encoder1 pulse input (bit 0 ~ 2)	0: CW/CCW (x1)
	1: PULSE/DIR (x1)
	2: PULSE/DIR (x2)
	3: PHASE A/B (x1)
	4: PHASE A/B (x2)
	5: PHASE A/B (x3)
Encoder1 Z phase clear(bit 3)	0: Disable, 1: Enable
Encoder2 pulse input (bit 4 ~ 6)	0: CW/CCW (x1)
	1: PULSE/DIR (x1)
	2: PULSE/DIR (x2)
	3: PHASE A/B (x1)
	4: PHASE A/B (x2)
	5: PHASE A/B (x3)
Encoder2 Z phase clear (bit 7)	0: Disable, 1: Enable
Speed override mode (bit 8)	0: Specify %, 1: Specify speed

App2.2. 1-axis operation data memory address

2.2.1. Axis Memory Addressing Formula

Step	Target position		Cir. int. auxiliary point		Operation speed		Dwell time	M code	Sub. Axis setting	Helical int.	Circular int. turns	Control word
	Low	High	Low	High	Low	High						
n Step	542 +12n	543 +12n	544 +12n	545 +12n	546 +12n	547 +12n	548 +12n	549 +12n	550 +12n	551 +12n	552 +12n	553 +12n

2.2.2. 1-Axis Memory Addressing Example

Step	Target position		Cir. int. auxiliary point		Operation speed		Dwell time	M code	Sub. Axis setting	Helical int.	Circular int. turns	Control word
	Low	High	Low	High	Low	High						
1	554	555	556	557	558	559	560	561	562	563	564	565
2	566	567	568	569	570	571	572	573	574	575	576	577
3	578	579	580	581	582	583	584	585	586	587	588	589
4	590	591	592	593	594	595	596	597	598	599	600	601
5	602	603	604	605	606	607	608	609	610	611	612	613
6	614	615	616	617	618	619	620	621	622	623	624	625
7	626	627	628	629	630	631	632	633	634	635	636	637
8	638	639	640	641	642	643	644	645	646	647	648	649
9	650	651	652	653	654	655	656	657	658	659	660	661
10	662	663	664	665	666	667	668	669	670	671	672	673
... 11~389 Step: Refer to addressing formula ...												
390	5222	5223	5224	5225	5226	5227	5228	5229	5230	5231	5232	5233
391	5234	5235	5236	5237	5238	5239	5240	5241	5242	5243	5244	5245
392	5246	5247	5248	5249	5250	5251	5252	5253	5254	5255	5256	5257
393	5258	5259	5260	5261	5262	5263	5264	5265	5266	5267	5268	5269
394	5270	5271	5272	5273	5274	5275	5276	5277	5278	5279	5280	5281
395	5282	5283	5284	5285	5286	5287	5288	5289	5290	5291	5292	5293
396	5294	5295	5296	5297	5298	5299	5300	5301	5302	5303	5304	5305
397	5306	5307	5308	5309	5310	5311	5312	5313	5314	5315	5316	5317
398	5318	5319	5320	5321	5322	5323	5324	5325	5326	5327	5328	5329
399	5330	5331	5332	5333	5334	5335	5336	5337	5338	5339	5340	5341
400	5342	5343	5344	5345	5346	5347	5348	5349	5350	5351	5352	5353

App2.3. 2-axis operation data memory address

2.3.1. 2-Axis Memory Addressing Formula

Step	Target position		Cir. int. auxiliary point		Operation speed		Dwell time	M code	Sub. Axis setting	Helical int.	Circular int. turns	Control word
	Low	High	Low	High	Low	High						
n	5342 +12n	5343 +12n	5344 +12n	5345 +12n	5346 +12n	5347 +12n	5348 +12n	5349 +12n	5350 +12n	5351 +12n	5352 +12n	5353 +12n

2.3.2. 2-Axis Memory Addressing Example

Step	Target position		Cir. int. auxiliary point		Operation speed		Dwell time	M code	Sub. Axis setting	Helical int.	Circular int. turns	Control word
	Low	High	Low	High	Low	High						
1	5354	5355	5356	5357	5358	5359	5360	5361	5362	5363	5364	5365
2	5366	5367	5368	5369	5370	5371	5372	5373	5374	5375	5376	5377
3	5378	5379	5380	5381	5382	5383	5384	5385	5386	5387	5388	5389
4	5390	5391	5392	5393	5394	5395	5396	5397	5398	5399	5400	5401
5	5402	5403	5404	5405	5406	5407	5408	5409	5410	5411	5412	5413
6	5414	5415	5416	5417	5418	5419	5420	5421	5422	5423	5424	5425
7	5426	5427	5428	5429	5430	5431	5432	5433	5434	5435	5436	5437
8	5438	5439	5440	5441	5442	5443	5444	5445	5446	5447	5448	5449
9	5450	5451	5452	5453	5454	5455	5456	5457	5458	5459	5460	5461
10	5462	5463	5464	5465	5466	5467	5468	5469	5470	5471	5472	5473
... 11~389 Step: Refer to addressing formula ...												
390	1002	1002	1002	1002	1002	1002	1002	1002	1003	1003	10032	10033
391	1003	1003	1003	1003	1003	1003	1004	1004	1004	1004	10044	10045
392	1004	1004	1004	1004	1005	1005	1005	1005	1005	1005	10056	10057
393	1005	1005	1006	1006	1006	1006	1006	1006	1006	1006	10068	10069
394	1007	1007	1007	1007	1007	1007	1007	1007	1007	1007	10080	10081
395	1008	1008	1008	1008	1008	1008	1008	1008	1009	1009	10092	10093
396	1009	1009	1009	1009	1009	1009	1010	1010	1010	1010	10104	10105
397	1010	1010	1010	1010	1011	1011	1011	1011	1011	1011	10116	10117
398	1011	1011	1012	1012	1012	1012	1012	1012	1012	1012	10128	10129
399	1013	1013	1013	1013	1013	1013	1013	1013	1013	1013	10140	10141
400	1014	1014	1014	1014	1014	1014	1014	1014	1015	1015	10152	10153

App2.4. 3-axis operation data memory address

2.4.1. 3- Axis Memory Addressing Formula

Step	Target position		Cir. int. auxiliary point		Operation speed		Dwell time	M code	Sub. Axis setting	Helical int.	Circular int. turns	Control word
	Low	High	Low	High	Low	High						
n Step	1014 2 +12n	1014 3 +12n	1014 4 +12n	1014 5 +12n	1014 6 +12n	1014 7 +12n	1014 8 +12n	1014 9 +12n	1015 0 +12n	1015 1 +12n	10152 +12n	10153 +12n

2.4.2. 3-Axis Memory Addressing Example

Step	Target position		Cir. int. auxiliary point		Operation speed		Dwell time	M code	Sub. Axis setting	Helical int.	Circular int. turns	Control word
	Low	High	Low	High	Low	High						
1	10154	10155	10156	10157	10158	10159	10160	10161	10162	10163	10164	10165
2	10166	10167	10168	10169	10170	10171	10172	10173	10174	10175	10176	10177
3	10178	10179	10180	10181	10182	10183	10184	10185	10186	10187	10188	10189
4	10190	10191	10192	10193	10194	10195	10196	10197	10198	10199	10200	10201
5	10202	10203	10204	10205	10206	10207	10208	10209	10210	10211	10212	10213
6	10214	10215	10216	10217	10218	10219	10220	10221	10222	10223	10224	10225
7	10226	10227	10228	10229	10230	10231	10232	10233	10234	10235	10236	10237
8	10238	10239	10240	10241	10242	10243	10244	10245	10246	10247	10248	10249
9	10250	10251	10252	10253	10254	10255	10256	10257	10258	10259	10260	10261
10	10262	10263	10264	10265	10266	10267	10268	10269	10270	10271	10272	10273
... 11~389 Step: Refer to addressing formula ...												
390	14822	14823	14824	14825	14826	14827	14828	14829	14830	14831	14832	14833
391	14834	14835	14836	14837	14838	14839	14840	14841	14842	14843	14844	14845
392	14846	14847	14848	14849	14850	14851	14852	14853	14854	14855	14856	14857
393	14858	14859	14860	14861	14862	14863	14864	14865	14866	14867	14868	14869
394	14870	14871	14872	14873	14874	14875	14876	14877	14878	14879	14880	14881
395	14882	14883	14884	14885	14886	14887	14888	14889	14890	14891	14892	14893
396	14894	14895	14896	14897	14898	14899	14900	14901	14902	14903	14904	14905
397	14906	14907	14908	14909	14910	14911	14912	14913	14914	14915	14916	14917
398	14918	14919	14920	14921	14922	14923	14924	14925	14926	14927	14928	14929
399	14930	14931	14932	14933	14934	14935	14936	14937	14938	14939	14940	14941
400	14942	14943	14944	14945	14946	14947	14948	14949	14950	14951	14952	14953

App2.5. 4-axis operation data memory address

2.5.1. 4-Axis Memory Addressing Formula

Step	Target position		Cir. int. auxiliary point		Operation speed		Dwell time	M code	Sub. Axis setting	Helical int.	Circular int. turns	Control word
	Low	High	Low	High	Low	High						
n Step	14942 +12n	14943 +12n	14944 +12n	14945 +12n	14946 +12n	14947 +12n	14948 +12n	14949 +12n	14950 +12n	14951 +12n	14952 +12n	14953 +12n

2.5.2. 4-Axis Memory Addressing Example

Step	Target position		Cir. int. auxiliary point		Operation speed		Dwell time	M code	Sub. Axis setting	Helical int.	Circular int. turns	Control word
	Low	High	Low	High	Low	High						
1	14954	14955	14956	14957	14958	14959	14960	14961	14962	14963	14964	14965
2	14966	14967	14968	14969	14970	14971	14972	14973	14974	14975	14976	14977
3	14978	14979	14980	14981	14982	14983	14984	14985	14986	14987	14988	14989
4	14990	14991	14992	14993	14994	14995	14996	14997	14998	14999	15000	15001
5	15002	15003	15004	15005	15006	15007	15008	15009	15010	15011	15012	15013
6	15014	15015	15016	15017	15018	15019	15020	15021	15022	15023	15024	15025
7	15026	15027	15028	15029	15030	15031	15032	15033	15034	15035	15036	15037
8	15038	15039	15040	15041	15042	15043	15044	15045	15046	15047	15048	15049
9	15050	15051	15052	15053	15054	15055	15056	15057	15058	15059	15060	15061
10	15062	15063	15064	15065	15066	15067	15068	15069	15070	15071	15072	15073
... 11~389 Step: Refer to addressing formula ...												
390	19622	19623	19624	19625	19626	19627	19628	19629	19630	19631	19632	19633
391	19634	19635	19636	19637	19638	19639	19640	19641	19642	19643	19644	19645
392	19646	19647	19648	19649	19650	19651	19652	19653	19654	19655	19656	19657
393	19658	19659	19660	19661	19662	19663	19664	19665	19666	19667	19668	19669
394	19670	19671	19672	19673	19674	19675	19676	19677	19678	19679	19680	19681
395	19682	19683	19684	19685	19686	19687	19688	19689	19690	19691	19692	19693
396	19694	19695	19696	19697	19698	19699	19700	19701	19702	19703	19704	19705
397	19706	19707	19708	19709	19710	19711	19712	19713	19714	19715	19716	19717

Appendix2 Module Internal Memory Address of 'Read/Write Variable Data' Command

398	1971 8	1971 9	1972 0	1972 1	1972 2	1972 3	1972 4	1972 5	1972 6	1972 7	19728	19729
399	1973 0	1973 1	1973 2	1973 3	1973 4	1973 5	1973 6	1973 7	1973 8	1973 9	19740	19741
400	1974 2	1974 3	1974 4	1974 5	1974 6	1974 7	1974 8	1974 9	1975 0	1975 1	19752	19753

App2.6. 5-axis operation data memory address

2.6.1. 5-Axis Memory Addressing Formula

Step	Target position		Cir. int. auxiliary point		Operation speed		Dwell time	M code	Sub. Axis setting	Helical int.	Circular int. turns	Control word
	Low	High	Low	High	Low	High						
n Step	19742 +12n	19743 +12n	19744 +12n	19745 +12n	19746 +12n	19747 +12n	19748 +12n	19749 +12n	19750 +12n	19751 +12n	19752 +12n	19753 +12n

2.6.2. 5-Axis Memory Addressing Example

Step	Target position		Cir. int. auxiliary point		Operation speed		Dwell time	M code	Sub. Axis setting	Helical int.	Circular int. turns	Control word
	Low	High	Low	High	Low	High						
1	19754	19755	19756	19757	19758	19759	19760	19761	19762	19763	19764	19765
2	19766	19767	19768	19769	19770	19771	19772	19773	19774	19775	19776	19777
3	19778	19779	19780	19781	19782	19783	19784	19785	19786	19787	19788	19789
4	19790	19791	19792	19793	19794	19795	19796	19797	19798	19799	19800	19801
5	19802	19803	19804	19805	19806	19807	19808	19809	19810	19811	19812	19813
6	19814	19815	19816	19817	19818	19819	19820	19821	19822	19823	19824	19825
7	19826	19827	19828	19829	19830	19831	19832	19833	19834	19835	19836	19837
8	19838	19839	19840	19841	19842	19843	19844	19845	19846	19847	19848	19849
9	19850	19851	19852	19853	19854	19855	19856	19857	19858	19859	19860	19861
10	19862	19863	19864	19865	19866	19867	19868	19869	19870	19871	19872	19873
... 11~389 Step: Refer to addressing formula ...												
390	24422	24423	24424	24425	24426	24427	24428	24429	24430	24431	24432	24433
391	24434	24435	24436	24437	24438	24439	24440	24441	24442	24443	24444	24445
392	24446	24447	24448	24449	24450	24451	24452	24453	24454	24455	24456	24457
393	24458	24459	24460	24461	24462	24463	24464	24465	24466	24467	24468	24469
394	24470	24471	24472	24473	24474	24475	24476	24477	24478	24479	24480	24481
395	24482	24483	24484	24485	24486	24487	24488	24489	24490	24491	24492	24493
396	24494	24495	24496	24497	24498	24499	24500	24501	24502	24503	24504	24505
397	24506	24507	24508	24509	24510	24511	24512	24513	24514	24515	24516	24517
398	24518	24519	24520	24521	24522	24523	24524	24525	24526	24527	24528	24529
399	24530	24531	24532	24533	24534	24535	24536	24537	24538	24539	24540	24541
400	24542	24543	24544	24545	24546	24547	24548	24549	24550	24551	24552	24553

App2.7. 6-axis operation data memory address

2.7.1. 6-Axis Memory Addressing Formula

Step	Target position		Cir. int. auxiliary point		Operation speed		Dwell time	M code	Sub. Axis setting	Helical int.	Circular int. turns	Control word
	Low	High	Low	High	Low	High						
n Step	24542 +12n	24543 +12n	24544 +12n	24545 +12n	24546 +12n	24547 +12n	24548 +12n	24549 +12n	24550 +12n	24551 +12n	24552 +12n	24553 +12n

2.7.2. 6-Axis Memory Addressing Example

Step	Target position		Cir. int. auxiliary point		Operation speed		Dwell time	M code	Sub. Axis setting	Helical int.	Circular int. turns	Control word
	Low	High	Low	High	Low	High						
1	24554	24555	24556	24557	24558	24559	24560	24561	24562	24563	24564	24565
2	24566	24567	24568	24569	24570	24571	24572	24573	24574	24575	24576	24577
3	24578	24579	24580	24581	24582	24583	24584	24585	24586	24587	24588	24589
4	24590	24591	24592	24593	24594	24595	24596	24597	24598	24599	24600	24601
5	24602	24603	24604	24605	24606	24607	24608	24609	24610	24611	24612	24613
6	24614	24615	24616	24617	24618	24619	24620	24621	24622	24623	24624	24625
7	24626	24627	24628	24629	24630	24631	24632	24633	24634	24635	24636	24637
8	24638	24639	24640	24641	24642	24643	24644	24645	24646	24647	24648	24649
9	24650	24651	24652	24653	24654	24655	24656	24657	24658	24659	24660	24661
10	24662	24663	24664	24665	24666	24667	24668	24669	24670	24671	24672	24673
... 11~389 Step: Refer to addressing formula ...												
390	29222	29223	29224	29225	29226	29227	29228	29229	29230	29231	29232	29233
391	29234	29235	29236	29237	29238	29239	29240	29241	29242	29243	29244	29245
392	29246	29247	29248	29249	29250	29251	29252	29253	29254	29255	29256	29257
393	29258	29259	29260	29261	29262	29263	29264	29265	29266	29267	29268	29269
394	29270	29271	29272	29273	29274	29275	29276	29277	29278	29279	29280	29281
395	29282	29283	29284	29285	29286	29287	29288	29289	29290	29291	29292	29293
396	29294	29295	29296	29297	29298	29299	29300	29301	29302	29303	29304	29305
397	29306	29307	29308	29309	29310	29311	29312	29313	29314	29315	29316	29317
398	29318	29319	29320	29321	29322	29323	29324	29325	29326	29327	29328	29329
399	29330	29331	29332	29333	29334	29335	29336	29337	29338	29339	29340	29341
400	29342	29343	29344	29345	29346	29347	29348	29349	29350	29351	29352	29353

App2.8. 7-axis operation data memory address

2.8.1. 7-Axis Memory Addressing Formula

Step	Target position		Cir. int. auxiliary point		Operation speed		Dwell time	M code	Sub. Axis setting	Helical int.	Circular int. turns	Control word
	Low	High	Low	High	Low	High						
n Step	2934 +12n	2934 +12n	2934 +12n	2934 +12n	2934 +12n	2934 +12n	2934 +12n	2934 +12n	2935 +12n	2935 +12n	29352 +12n	29353 +12n

2.8.2. 7-Axis Memory Addressing Example

Step	Target position		Cir. int. auxiliary point		Operation speed		Dwell time	M code	Sub. Axis setting	Helical int.	Circular int. turns	Control word
	Low	High	Low	High	Low	High						
1	29354	29355	29356	29357	29358	29359	29360	29361	29362	29363	29364	29365
2	29366	29367	29368	29369	29370	29371	29372	29373	29374	29375	29376	29377
3	29378	29379	29380	29381	29382	29383	29384	29385	29386	29387	29388	29389
4	29390	29391	29392	29393	29394	29395	29396	29397	29398	29399	29400	29401
5	29402	29403	29404	29405	29406	29407	29408	29409	29410	29411	29412	29413
6	29414	29415	29416	29417	29418	29419	29420	29421	29422	29423	29424	29425
7	29426	29427	29428	29429	29430	29431	29432	29433	29434	29435	29436	29437
8	29438	29439	29440	29441	29442	29443	29444	29445	29446	29447	29448	29449
9	29450	29451	29452	29453	29454	29455	29456	29457	29458	29459	29460	29461
10	29462	29463	29464	29465	29466	29467	29468	29469	29470	29471	29472	29473
... 11~389 Step: Refer to addressing formula ...												
390	34022	34023	34024	34025	34026	34027	34028	34029	34030	34031	34032	34033
391	34034	34035	34036	34037	34038	34039	34040	34041	34042	34043	34044	34045
392	34046	34047	34048	34049	34050	34051	34052	34053	34054	34055	34056	34057
393	34058	34059	34060	34061	34062	34063	34064	34065	34066	34067	34068	34069
394	34070	34071	34072	34073	34074	34075	34076	34077	34078	34079	34080	34081
395	34082	34083	34084	34085	34086	34087	34088	34089	34090	34091	34092	34093
396	34094	34095	34096	34097	34098	34099	34100	34101	34102	34103	34104	34105
397	34106	34107	34108	34109	34110	34111	34112	34113	34114	34115	34116	34117
398	34118	34119	34120	34121	34122	34123	34124	34125	34126	34127	34128	34129
399	34130	34131	34132	34133	34134	34135	34136	34137	34138	34139	34140	34141
400	34142	34143	34144	34145	34146	34147	34148	34149	34150	34151	34152	34153

App2.9. 8-axis operation data memory address

2.9.1. 8-Axis Memory Addressing Formula

Step	Target position		Cir. int. auxiliary point		Operation speed		Dwell time	M code	Sub. Axis setting	Helical int.	Circular int. turns	Control word
	Low	High	Low	High	Low	High						
n Step	34142 +12n	34143 +12n	34144 +12n	34145 +12n	34146 +12n	34147 +12n	34148 +12n	34149 +12n	34150 +12n	34151 +12n	34152 +12n	34153 +12n

2.9.2. 8-Axis Memory Addressing Example

Step	Target position		Cir. int. auxiliary point		Operation speed		Dwell time	M code	Sub. Axis setting	Helical int.	Circular int. turns	Control word
	Low	High	Low	High	Low	High						
1	34154	34155	34156	34157	34158	34159	34160	34161	34162	34163	34164	34165
2	34166	34167	34168	34169	34170	34171	34172	34173	34174	34175	34176	34177
3	34178	34179	34180	34181	34182	34183	34184	34185	34186	34187	34188	34189
4	34190	34191	34192	34193	34194	34195	34196	34197	34198	34199	34200	34201
5	34202	34203	34204	34205	34206	34207	34208	34209	34210	34211	34212	34213
6	34214	34215	34216	34217	34218	34219	34220	34221	34222	34223	34224	34225
7	34226	34227	34228	34229	34230	34231	34232	34233	34234	34235	34236	34237
8	34238	34239	34240	34241	34242	34243	34244	34245	34246	34247	34248	34249
9	34250	34251	34252	34253	34254	34255	34256	34257	34258	34259	34260	34261
10	34262	34263	34264	34265	34266	34267	34268	34269	34270	34271	34272	34273
... 11~389 Step: Refer to addressing formula ...												
390	38822	38823	38824	38825	38826	38827	38828	38829	38830	38831	38832	38833
391	38834	38835	38836	38837	38838	38839	38840	38841	38842	38843	38844	38845
392	38846	38847	38848	38849	38850	38851	38852	38853	38854	38855	38856	38857
393	38858	38859	38860	38861	38862	38863	38864	38865	38866	38867	38868	38869
394	38870	38871	38872	38873	38874	38875	38876	38877	38878	38879	38880	38881
395	38882	38883	38884	38885	38886	38887	38888	38889	38890	38891	38892	38893
396	38894	38895	38896	38897	38898	38899	38900	38901	38902	38903	38904	38905
397	38906	38907	38908	38909	38910	38911	38912	38913	38914	38915	38916	38917
398	38918	38919	38920	38921	38922	38923	38924	38925	38926	38927	38928	38929
399	38930	38931	38932	38933	38934	38935	38936	38937	38938	38939	38940	38941
400	38942	38943	38944	38945	38946	38947	38948	38949	38950	38951	38952	38953

App2.10. Control Word-Operational Data

(1) Control word

Bit position	Contents
Coordinate (bit 0)	0: ABS, 1: INC
Control method (bit 1~3)	0: single axis position control, 1: single axis speed control, 2: single axis FEED control, 3: Linear interpolation, 4: Circular interpolation
Operation method (bit 4)	0: Single, 1: Repeat
Operation pattern (bit 5~6)	0: End, 1: Keep, 2: Continuous
Arc size (bit 7)	0: Arc<180, 1: Arc>=180
Acc. No. (bit 8~9)	0 ~ 3
Dec. No. (bit 10~11)	0 ~ 3
Circular interpolation mode (bit 12~13)	0: Middle point, 1: Center point, 2: Radius
Circular interpolation direction (bit 14)	0: CW, 1: CCW

App2.11. CAM data memory address

Item	Block 1	Block 2	Block 3	Block 4	Block 5	Block 6	Block 7	Block 8	
Main axis travel distance per rotation	38954	43184	47414	51644	55874	60104	64334	68564	
Main axis pulse per rotation	38956	43186	47416	51646	55876	60106	64336	68566	
Sub axis travel distance per rotation	38958	43188	47418	51648	55878	60108	64338	68568	
Sub axis pulse per rotation	38960	43190	47420	51650	55880	60110	64340	68570	
CAM profile data count (WORD)	38962	43192	47422	51652	55882	60112	64342	68572	
Parameter and control mode (WORD) Bit 0~1 : main axis unit Bit 2~3 : sub axis unit Bit 8 : control method (0:Repeat,1:Increase)	38963	43193	47423	51653	55883	60113	64343	68573	
CAM block data 1	Main axis end pos.	38964	43194	47424	51654	55884	60114	64344	68574
	Sub axis end pos.	38966	43196	47426	51656	55886	60116	64346	68576
	CAM Curve	38968	43198	47428	51658	55888	60118	64348	68578
CAM block data 2	Main axis end pos.	38970	43200	47430	51660	55890	60120	64350	68580
	Sub axis end pos.	38972	43202	47432	51662	55892	60122	64352	68582
	CAM Curve	38974	43204	47434	51664	55894	60124	64354	68584
CAM block data 3	Main axis end pos.	38976	43206	47436	51666	55896	60126	64356	68586
	Sub axis end pos.	38978	43208	47438	51668	55898	60128	64358	68588
	CAM Curve	38980	43210	47440	51670	55900	60130	64360	68590
CAM block data 4	Main axis end pos.	38982	43212	47442	51672	55902	60132	64362	68592
	Sub axis end pos.	38984	43214	47444	51674	55904	60134	64364	68594
	CAM Curve	38986	43216	47446	51676	55906	60136	64366	68596
CAM block data 5	Main axis end pos.	38988	43218	47448	51678	55908	60138	64368	68598
	Sub axis end pos.	38990	43220	47450	51680	55910	60140	64370	68600

Appendix2 Module Internal Memory Address of 'Read/Write Variable Data' Command

Item		Block 1	Block 2	Block 3	Block 4	Block 5	Block 6	Block 7	Block 8
	CAM Curve	38992	43222	47452	51682	55912	60142	64372	68602
CAM block data 6	Main axis end pos.	38994	43224	47454	51684	55914	60144	64374	68604
	Sub axis end pos.	38996	43226	47456	51686	55916	60146	64376	68606
	CAM Curve	38998	43228	47458	51688	55918	60148	64378	68608
CAM block data 7	Main axis end pos.	39000	43230	47460	51690	55920	60150	64380	68610
	Sub axis end pos.	39002	43232	47462	51692	55922	60152	64382	68612
	CAM Curve	39004	43234	47464	51694	55924	60154	64384	68614
CAM block data 8	Main axis end pos.	39006	43236	47466	51696	55926	60156	64386	68616
	Sub axis end pos.	39008	43238	47468	51698	55928	60158	64388	68618
	CAM Curve	39010	43240	47470	51700	55930	60160	64390	68620
CAM block data 9	Main axis end pos.	39012	43242	47472	51702	55932	60162	64392	68622
	Sub axis end pos.	39014	43244	47474	51704	55934	60164	64394	68624
	CAM Curve	39016	43246	47476	51706	55936	60166	64396	68626
CAM block data 10	Main axis end pos.	39018	43248	47478	51708	55938	60168	64398	68628
	Sub axis end pos.	39020	43250	47480	51710	55940	60170	64400	68630
	CAM Curve	39022	43252	47482	51712	55942	60172	64402	68632
CAM block data 11	Main axis end pos.	39024	43254	47484	51714	55944	60174	64404	68634
	Sub axis end pos.	39026	43256	47486	51716	55946	60176	64406	68636
	CAM Curve	39028	43258	47488	51718	55948	60178	64408	68638
CAM block data 12	Main axis end pos.	39030	43260	47490	51720	55950	60180	64410	68640
	Sub axis end pos.	39032	43262	47492	51722	55952	60182	64412	68642

Appendix2 Module Internal Memory Address of 'Read/Write Variable Data' Command

Item		Block 1	Block 2	Block 3	Block 4	Block 5	Block 6	Block 7	Block 8
	CAM Curve	39034	43264	47494	51724	55954	60184	64414	68644
CAM block data 13	Main axis end pos.	39036	43266	47496	51726	55956	60186	64416	68646
	Sub axis end pos.	39038	43268	47498	51728	55958	60188	64418	68648
	CAM Curve	39040	43270	47500	51730	55960	60190	64420	68650
CAM block data 14	Main axis end pos.	39042	43272	47502	51732	55962	60192	64422	68652
	Sub axis end pos.	39044	43274	47504	51734	55964	60194	64424	68654
	CAM Curve	39046	43276	47506	51736	55966	60196	64426	68656
CAM block data 15	Main axis end pos.	39048	43278	47508	51738	55968	60198	64428	68658
	Sub axis end pos.	39050	43280	47510	51740	55970	60200	64430	68660
	CAM Curve	39052	43282	47512	51742	55972	60202	64432	68662
CAM block data 16	Main axis end pos.	39054	43284	47514	51744	55974	60204	64434	68664
	Sub axis end pos.	39056	43286	47516	51746	55976	60206	64436	68666
	CAM Curve	39058	43288	47518	51748	55978	60208	64438	68668
CAM block data 17	Main axis end pos.	39060	43290	47520	51750	55980	60210	64440	68670
	Sub axis end pos.	39062	43292	47522	51752	55982	60212	64442	68672
	CAM Curve	39064	43294	47524	51754	55984	60214	64444	68674
CAM block data 18	Main axis end pos.	39066	43296	47526	51756	55986	60216	64446	68676
	Sub axis end pos.	39068	43298	47528	51758	55988	60218	64448	68678
	CAM Curve	39070	43300	47530	51760	55990	60220	64450	68680
CAM block data 19	Main axis end pos.	39072	43302	47532	51762	55992	60222	64452	68682
	Sub axis	39074	43304	47534	51764	55994	60224	64454	68684

Appendix2 Module Internal Memory Address of 'Read/Write Variable Data' Command

Item	Block 1	Block 2	Block 3	Block 4	Block 5	Block 6	Block 7	Block 8	
	end pos.								
	CAM Curve	39076	43306	47536	51766	55996	60226	64456	68686
CAM block data 20	Main axis end pos.	39078	43308	47538	51768	55998	60228	64458	68688
	Sub axis end pos.	39080	43310	47540	51770	56000	60230	64460	68690
	CAM Curve	39082	43312	47542	51772	56002	60232	64462	68692
Point unit	39084	43314	47544	51774	56004	60234	64464	68694	
Main axis end position	39086	43316	47546	51776	56006	60236	64466	68696	

Item	Axis 1	Axis 2	Axis 3	Axis 4	Axis 5	Axis 6	Axis 7	Axis 8
CAM Data[0] (REAL)	39088	43318	47548	51778	56008	60238	64468	68698
CAM Data[1] (REAL)	39090	43320	47550	51780	56010	60240	64470	68700
CAM Data[2] (REAL)	39092	43322	47552	51782	56012	60242	64472	68702
CAM Data[3] (REAL)	39094	43324	47554	51784	56014	60244	64474	68704
CAM Data[4] (REAL)	39096	43326	47556	51786	56016	60246	64476	68706
CAM Data[5] (REAL)	39098	43328	47558	51788	56018	60248	64478	68708
CAM Data[6] (REAL)	39100	43330	47560	51790	56020	60250	64480	68710
CAM Data[7] (REAL)	39102	43332	47562	51792	56022	60252	64482	68712
CAM Data[8] (REAL)	39104	43334	47564	51794	56024	60254	64484	68714
CAM Data[9] (REAL)	39106	43336	47566	51796	56026	60256	64486	68716
CAM Data[10] (REAL)	39108	43338	47568	51798	56028	60258	64488	68718
. . .								
CAM Data[n](REAL)	39088 +2n	43318 +2n	47548 +2n	51778 +2n	56008 +2n	60238 +2n	64468 +2n	68698 +2n
. . .								
CAM Data[2040] (REAL)	43168	47398	51628	55858	60088	64318	68548	72778
CAM Data[2041] (REAL)	43170	47400	51630	55860	60090	64320	68550	72780
CAM Data[2042] (REAL)	43172	47402	51632	55862	60092	64322	68552	72782
CAM Data[2043] (REAL)	43174	47404	51634	55864	60094	64324	68554	72784
CAM Data[2044] (REAL)	43176	47406	51636	55866	60096	64326	68556	72786
CAM Data[2045] (REAL)	43178	47408	51638	55868	60098	64328	68558	72788
CAM Data[2046] (REAL)	43180	47410	51640	55870	60100	64330	68560	72790
CAM Data[2047] (REAL)	43182	47412	51642	55872	60102	64332	68562	72792

App2.12. User CAM Data Memory Address

Item	Axis 1	Axis 2	Axis 3	Axis 4	Axis 5	Axis 6	Axis 7	Axis 8
Number of user CAM data	72794	72916	73038	73160	73282	73404	73526	73648
Main axis position 1	72796	72918	73040	73162	73284	73406	73528	73650
Sub axis position 1	72798	72920	73042	73164	73286	73408	73530	73652
Main axis position 2	72800	72922	73044	73166	73288	73410	73532	73654
Sub axis position 2	72802	72924	73046	73168	73290	73412	73534	73656
Main axis position 3	72804	72926	73048	73170	73292	73414	73536	73658
Sub axis position 3	72806	72928	73050	73172	73294	73416	73538	73660
Main axis position 4	72808	72930	73052	73174	73296	73418	73540	73662
Sub axis position 4	72810	72932	73054	73176	73298	73420	73542	73664
Main axis position 5	72812	72934	73056	73178	73300	73422	73544	73666
Sub axis position 5	72814	72936	73058	73180	73302	73424	73546	73668
Main axis position 6	72816	72938	73060	73182	73304	73426	73548	73670
Sub axis position 6	72818	72940	73062	73184	73306	73428	73550	73672
Main axis position 7	72820	72942	73064	73186	73308	73430	73552	73674
Sub axis position 7	72822	72944	73066	73188	73310	73432	73554	73676
Main axis position 8	72824	72946	73068	73190	73312	73434	73556	73678
Sub axis position 8	72826	72948	73070	73192	73314	73436	73558	73680
Main axis position 9	72828	72950	73072	73194	73316	73438	73560	73682
Sub axis position 9	72830	72952	73074	73196	73318	73440	73562	73684
Main axis position 10	72832	72954	73076	73198	73320	73442	73564	73686
Sub axis position 10	72834	72956	73078	73200	73322	73444	73566	73688
Main axis position 11	72836	72958	73080	73202	73324	73446	73568	73690
Sub axis position 11	72838	72960	73082	73204	73326	73448	73570	73692
Main axis position 12	72840	72962	73084	73206	73328	73450	73572	73694
Sub axis position 12	72842	72964	73086	73208	73330	73452	73574	73696
Main axis position 13	72844	72966	73088	73210	73332	73454	73576	73698
Sub axis position 13	72846	72968	73090	73212	73334	73456	73578	73700
Main axis position 14	72848	72970	73092	73214	73336	73458	73580	73702
Sub axis position 14	72850	72972	73094	73216	73338	73460	73582	73704
Main axis position 15	72852	72974	73096	73218	73340	73462	73584	73706
Sub axis position 15	72854	72976	73098	73220	73342	73464	73586	73708
Main axis position 16	72856	72978	73100	73222	73344	73466	73588	73710
Sub axis position 16	72858	72980	73102	73224	73346	73468	73590	73712

Appendix2 Module Internal Memory Address of 'Read/Write Variable Data' Command

Item	Axis 1	Axis 2	Axis 3	Axis 4	Axis 5	Axis 6	Axis 7	Axis 8
Main axis position 17	72860	72982	73104	73226	73348	73470	73592	73714
Sub axis position 17	72862	72984	73106	73228	73350	73472	73594	73716
Main axis position 18	72864	72986	73108	73230	73352	73474	73596	73718
Sub axis position 18	72866	72988	73110	73232	73354	73476	73598	73720
Main axis position 19	72868	72990	73112	73234	73356	73478	73600	73722
Sub axis position 19	72870	72992	73114	73236	73358	73480	73602	73724
Main axis position 20	72872	72994	73116	73238	73360	73482	73604	73726
Sub axis position 20	72874	72996	73118	73240	73362	73484	73606	73728
Main axis position 21	72876	72998	73120	73242	73364	73486	73608	73730
Sub axis position 21	72878	73000	73122	73244	73366	73488	73610	73732
Main axis position 22	72880	73002	73124	73246	73368	73490	73612	73734
Sub axis position 22	72882	73004	73126	73248	73370	73492	73614	73736
Main axis position 23	72884	73006	73128	73250	73372	73494	73616	73738
Sub axis position 23	72886	73008	73130	73252	73374	73496	73618	73740
Main axis position 24	72888	73010	73132	73254	73376	73498	73620	73742
Sub axis position 24	72890	73012	73134	73256	73378	73500	73622	73744
Main axis position 25	72892	73014	73136	73258	73380	73502	73624	73746
Sub axis position 25	72894	73016	73138	73260	73382	73504	73626	73748
Main axis position 26	72896	73018	73140	73262	73384	73506	73628	73750
Sub axis position 26	72898	73020	73142	73264	73386	73508	73630	73752
Main axis position 27	72900	73022	73144	73266	73388	73510	73632	73754
Sub axis position 27	72902	73024	73146	73268	73390	73512	73634	73756
Main axis position 28	72904	73026	73148	73270	73392	73514	73636	73758
Sub axis position 28	72906	73028	73150	73272	73394	73516	73638	73760
Main axis position 29	72908	73030	73152	73274	73396	73518	73640	73762
Sub axis position 29	72910	73032	73154	73276	73398	73520	73642	73764
Main axis position 30	72912	73034	73156	73278	73400	73522	73644	73766
Sub axis position 30	72914	73036	73158	73280	73402	73524	73646	73768

Appendix3. Dimension

Appendix 3.1 Dimension of XBF-PN04B/PN08B

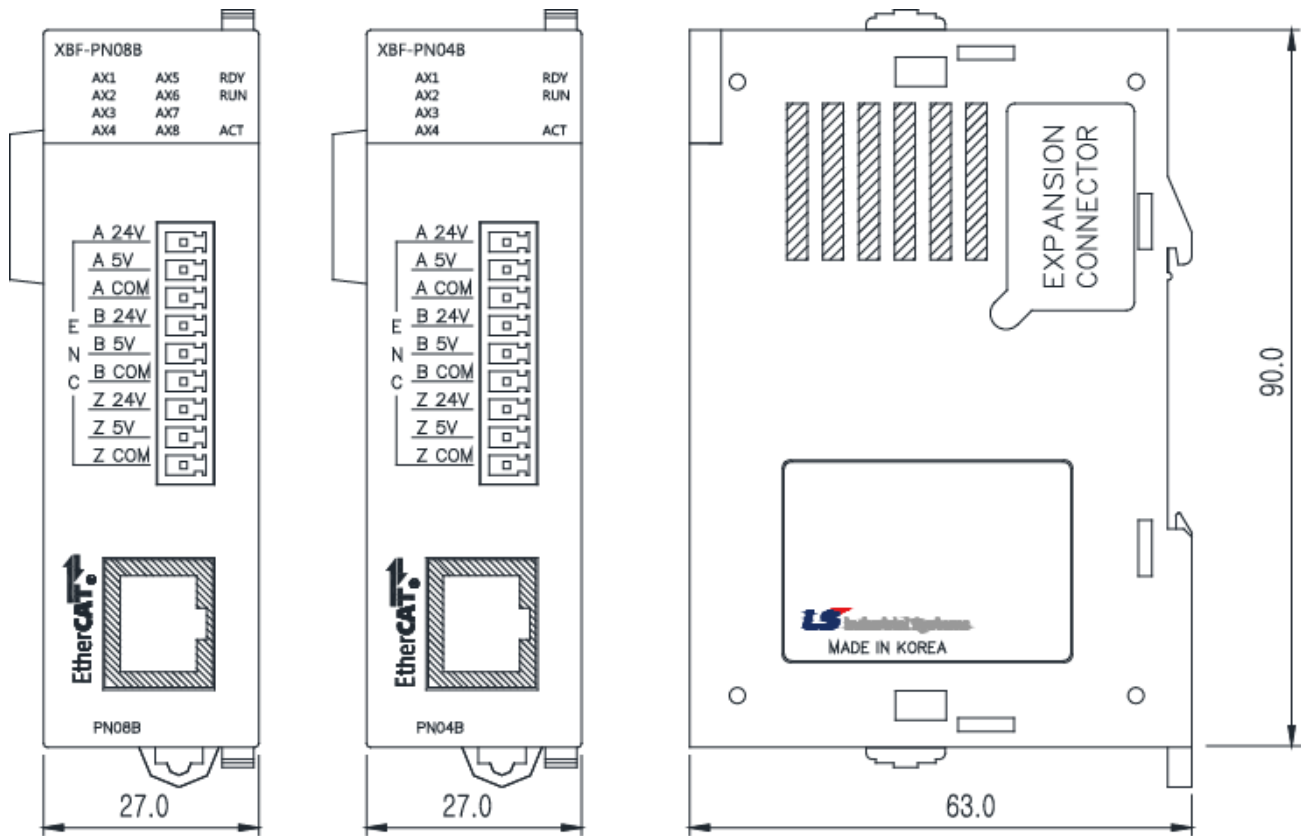

Appendix4. Setting Example

It describes how to set when using the positioning module at the beginning.

(1) Install the servo driver.

Connect the power and motor to the servo driver and connect external signal as necessary.

(2) Install PLC.

Install PLC and mount the positioning module. And at the beginning of test-run, for safety's sake, make sure PLC CPU is STOP mode.

(3) Connect the positioning module and servo driver.

Connect the positioning module and first servo driver by using Ethernet cable. And connect other servo drivers. At this time, check the I/O direction of communication port of the servo driver distinctly. The following is wiring diagram when connecting 8 servo drivers and applicable motor type per servo driver capacity.

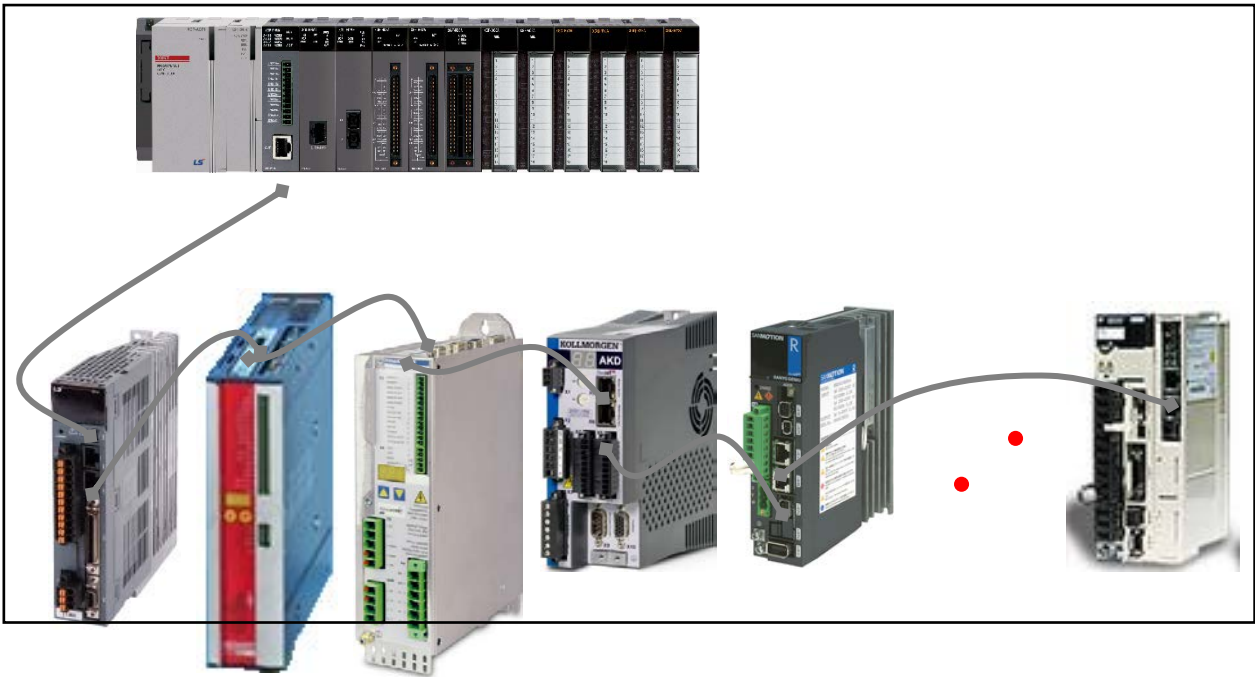

Maker	Applicable servo driver
LS Mecapion	L7N
Beckhoff Automation GmbH	AX2000-B110 EtherCAT Drive
Danaher Motion GmbH (KOLLMORGEN)	S300/S400/S600/S700 EtherCAT Drive AKD EtherCAT Drive(CoE)
Sanyodenki Co., Ltd	R ADVANCED MODEL with EtherCAT Coe Interface
Yaskawa Electric Corporation	SGDV-E1 EtherCAT(CoE) SERVOPACK Rev1, Rev2, Rev3

Remark

After installing a servo driver, make sure check the following items by using the dedicated tool provided by the servo driver maker. And if there is mismatch with actual settings, you have to set up again according to the condition you are using.

1) Power supply

Make sure that power connected to the servo driver is same as allowable power condition set in the parameter

(In some servo driver, there may be no power setting according to servo driver.)

2) Motor and encoder (feedback) type

Set up the parameter according to actual motor and encoder type.

3) Position unit setting

When position unit setting is available in servo driver parameter, you have to set up them as pulse unit (Inc. or Counts). And set up "Encoder resolution per rotation" according to encoder bit number.

(There may be no setting item according to servo driver type)

(4) Install XG5000 at the PC.

(5) Execute XG5000 and XG-PM by selecting "Tools – Position control"

(XG-PM is used for setting operation parameter, operation data and servo parameter or monitoring and etc.)

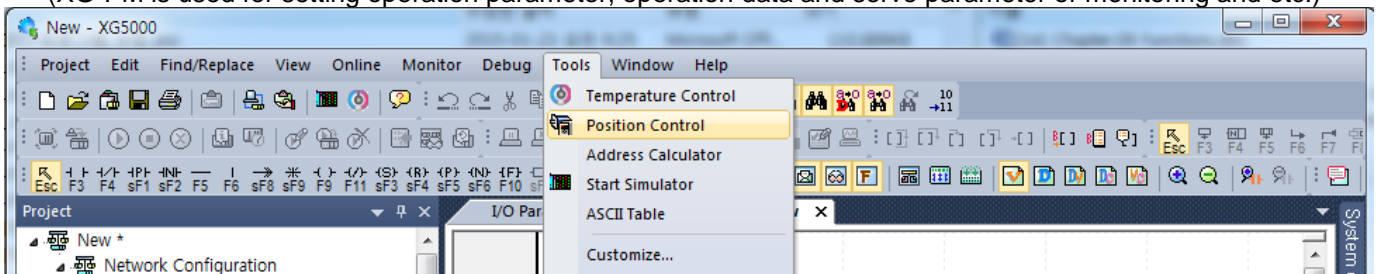

(6) If XG-PM is executed, create positioning project by selecting "Project – New Project".

Appendix4 Setting Example

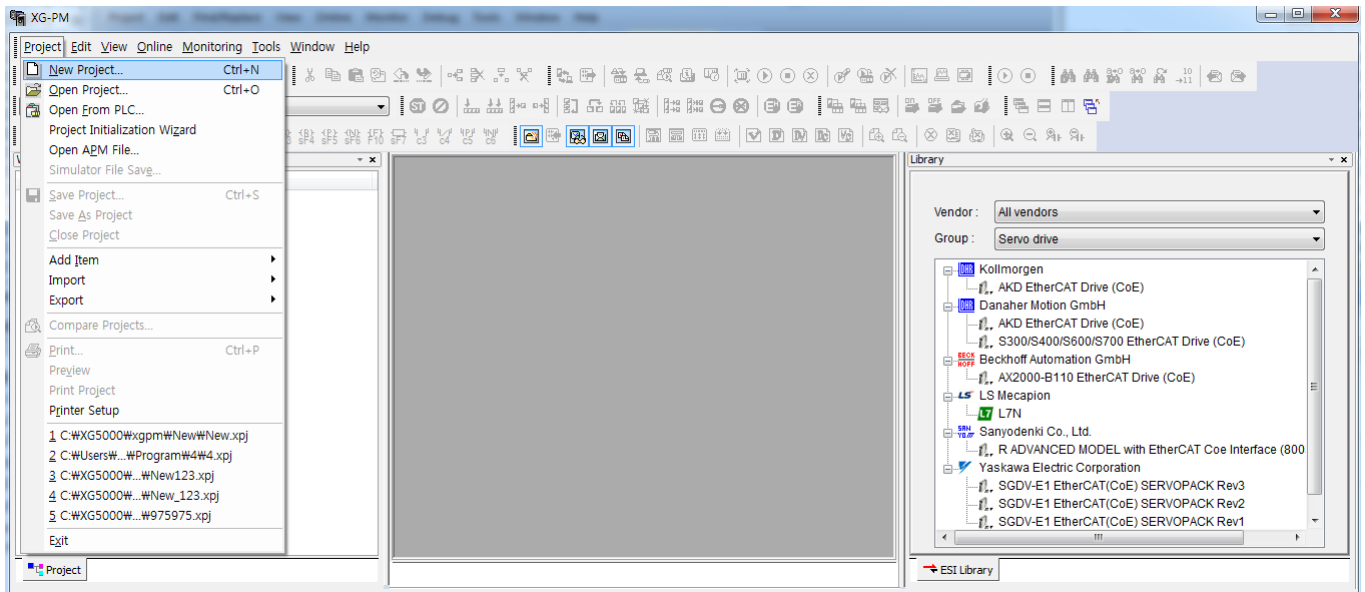

(7) In the figure below, set up Project name, PLC series, CPU type, Module name, Module type, Module position to create a new project.

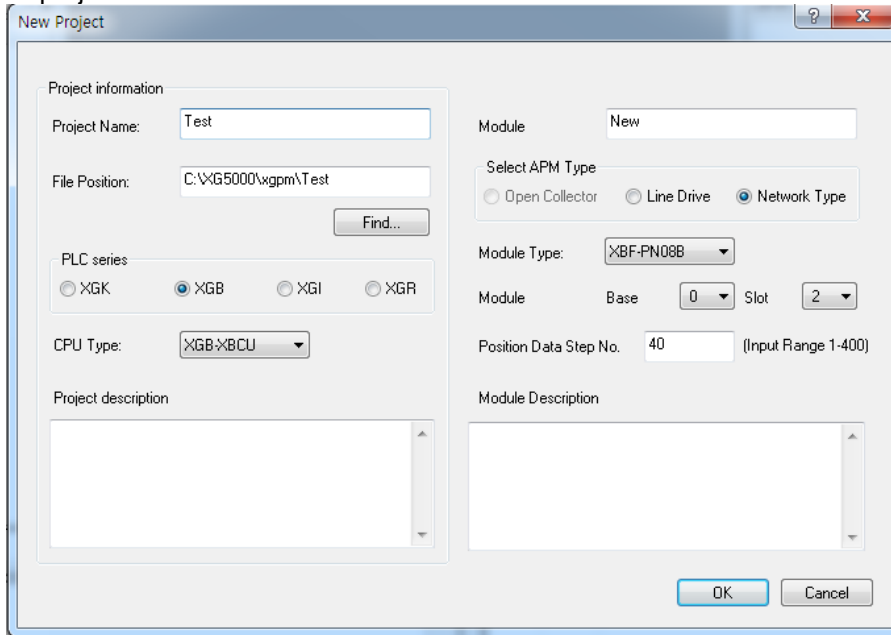

(8) If you set up as the figure above, the project will be created as follows.

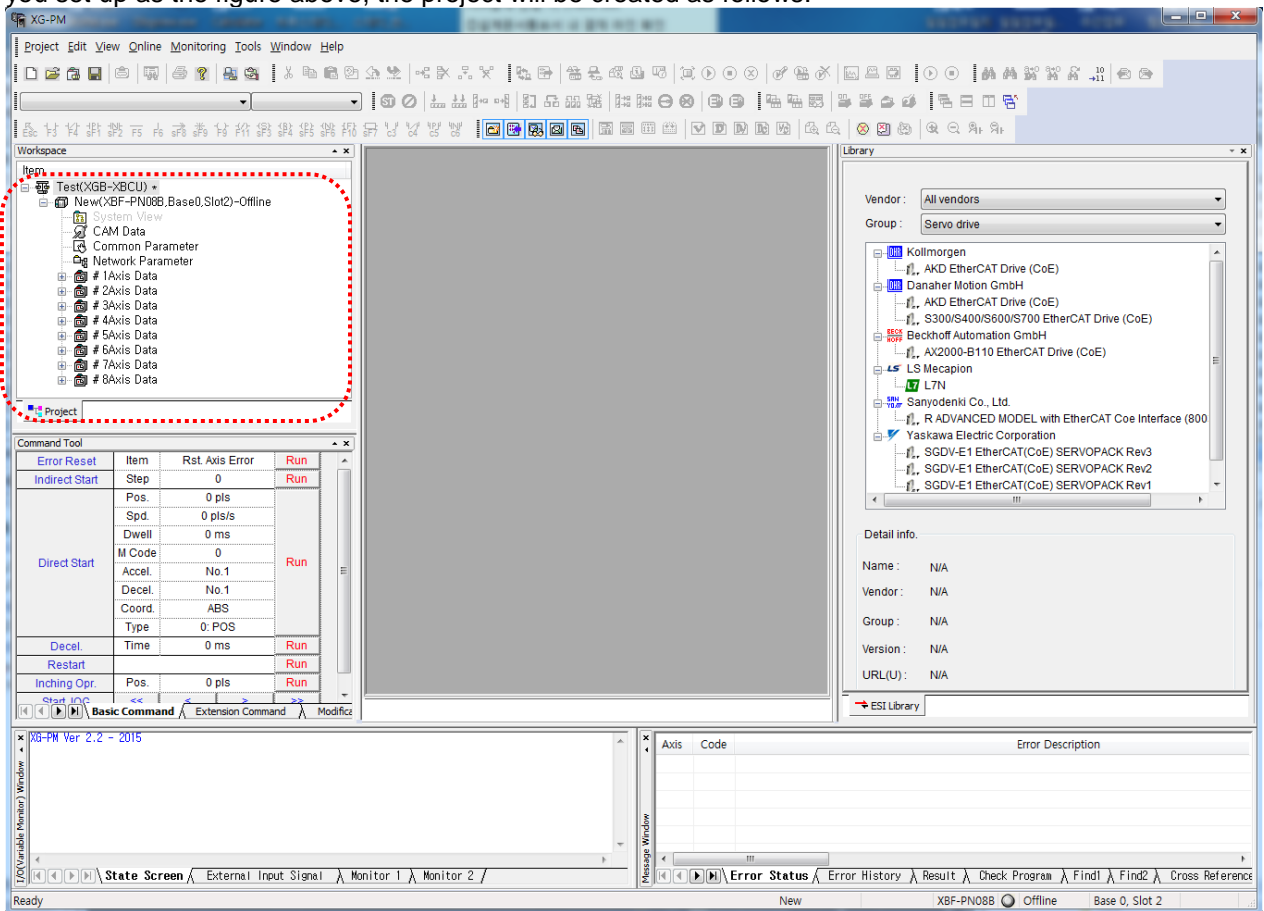

Appendix4 Setting Example

(9) Turn on PLC and servo driver and connect PC with PLC CPU through USB cable.

(10) Select “Online- Connection Setting” and set up connection settings.

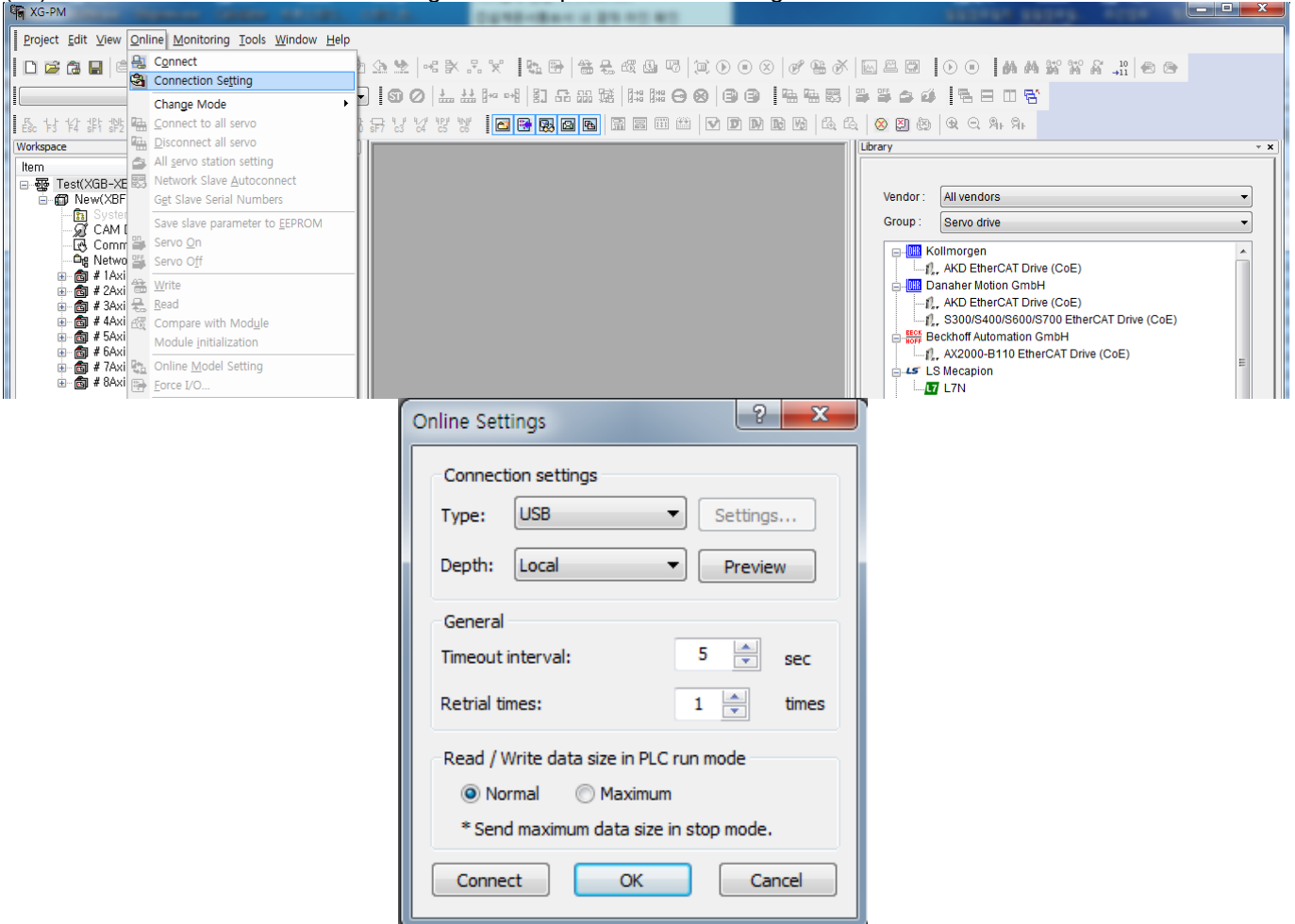

(11) Select “Online-Connect” to connect PC with PLC CPU.

(12) If connection is complete, the module will be shown in ‘Online’ as follows.

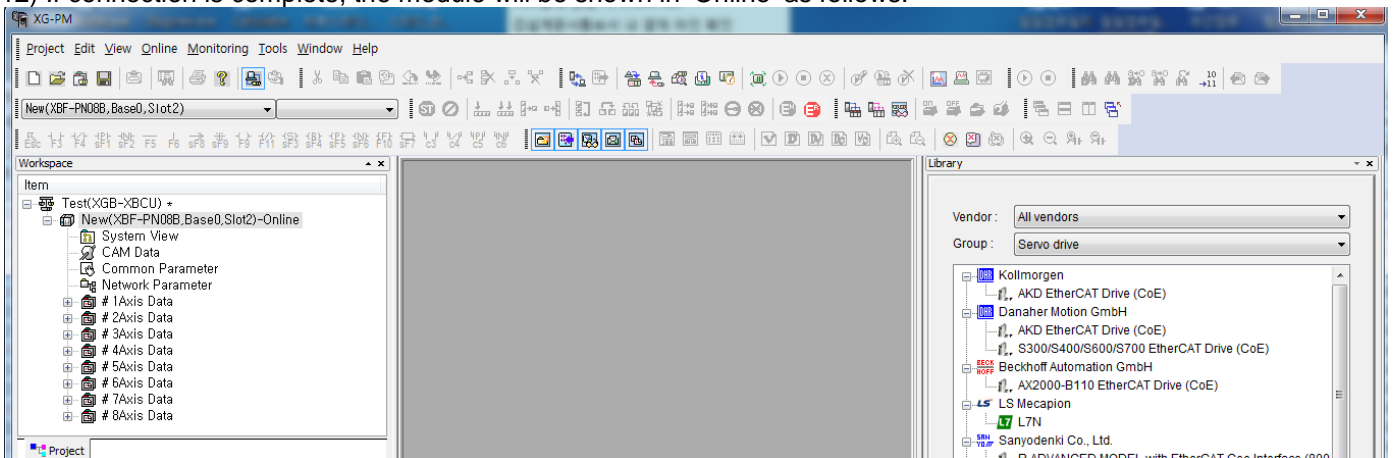

(13) If the module doesn't become “Online” and keeps “Offline”, check whether the module is mounted, position or type is correct.

(14) In order to connect with the servo driver, set up the actually connected servo driver at the network parameter and write it to the module. Before setting up network parameter, check whether the module is offline. In case of online, change it to offline by executing “Online – Disconnect”.

(15) In order to add the servo driver at the network parameter, click the right button of the module while cursor is on Network parameter and select “Add – Slave–Servo drive”.

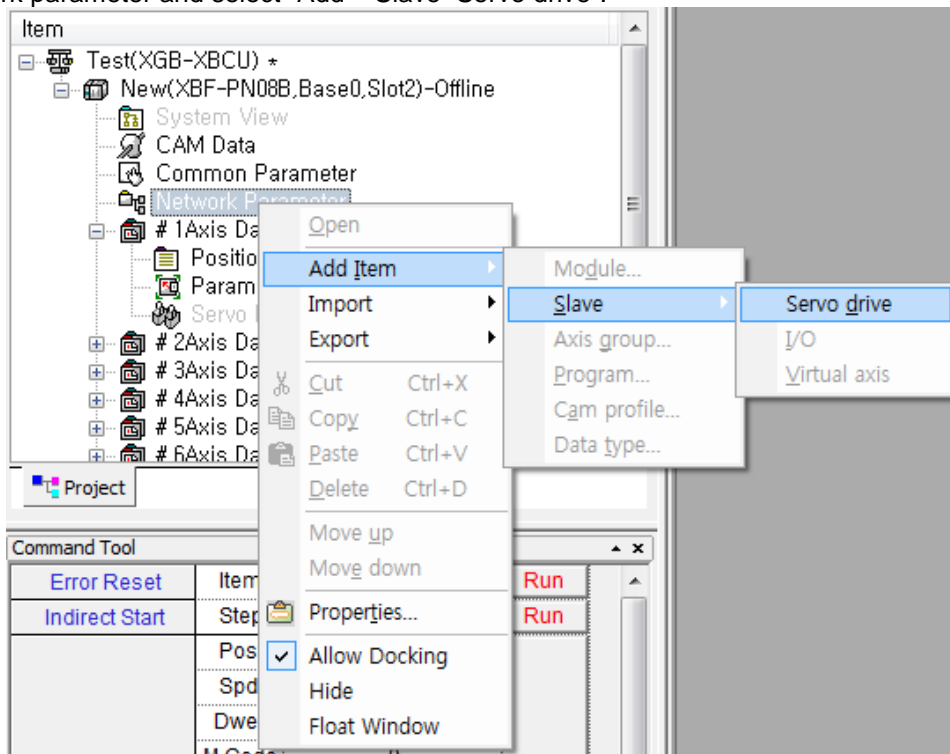

(16) If servo information window appears, click “...” button.

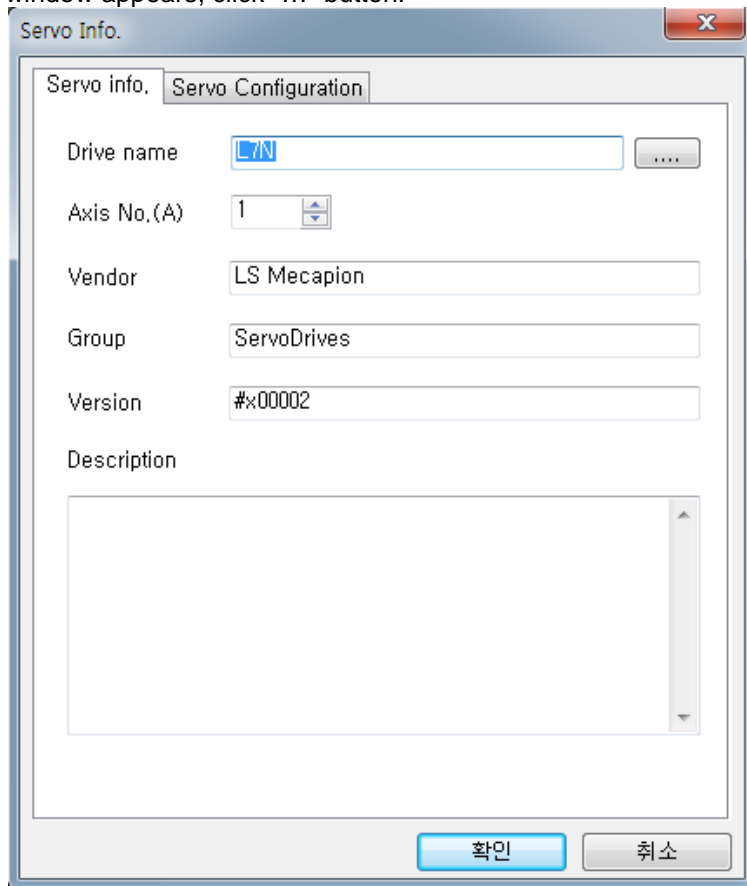

The image shows a software dialog box titled "Servo Info." with a close button (X) in the top right corner. The dialog has two tabs: "Servo info." and "Servo Configuration", with "Servo Configuration" currently selected. The fields are as follows:

- Drive name: A text box containing "L7N" with a blue selection highlight and a "..." button to its right.
- Axis No.(A): A spinner box with the value "1".
- Vendor: A text box containing "LS Mecapion".
- Group: A text box containing "ServoDrives".
- Version: A text box containing "#x00002".
- Description: A large empty text area with a vertical scrollbar on the right side.

At the bottom of the dialog, there are two buttons: "확인" (OK) and "취소" (Cancel).

(17) In “Servo drive selection” window, select the firstly connected servo driver and click OK.

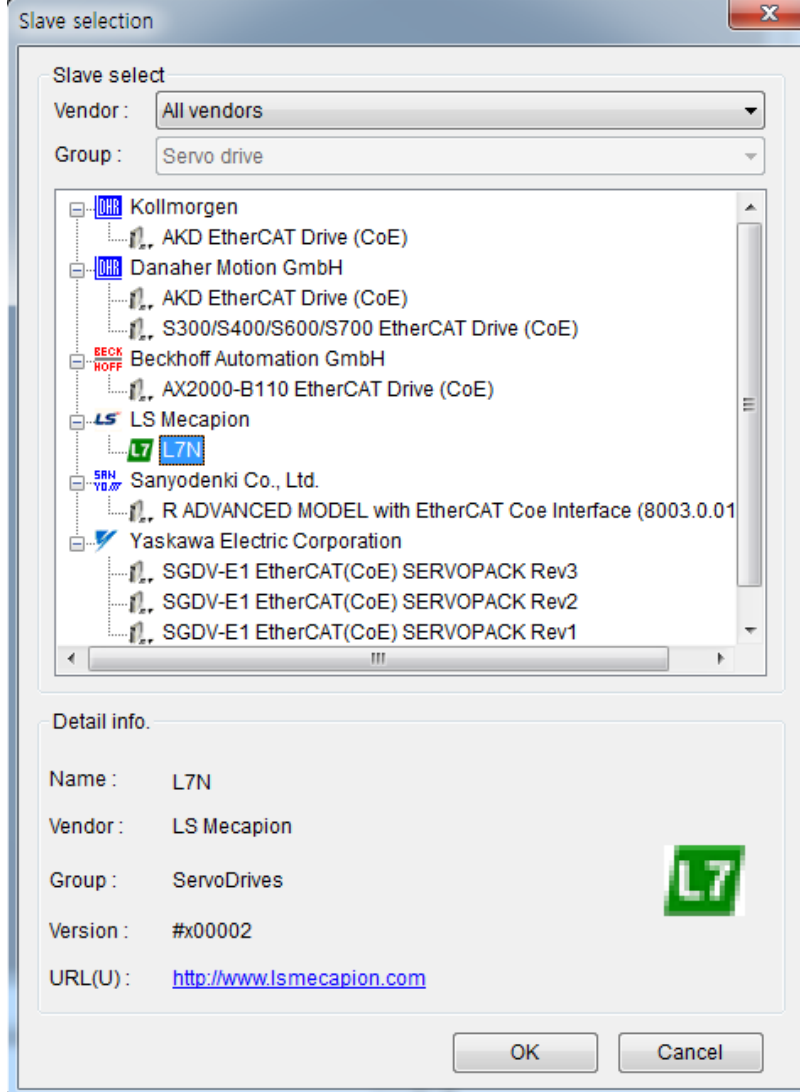

(18) In “Servo Info.” window, set up axis number of the selected servo driver. Connection sequence has nothing to do with axis number. This axis number becomes the command axis of the command/function block when programming.

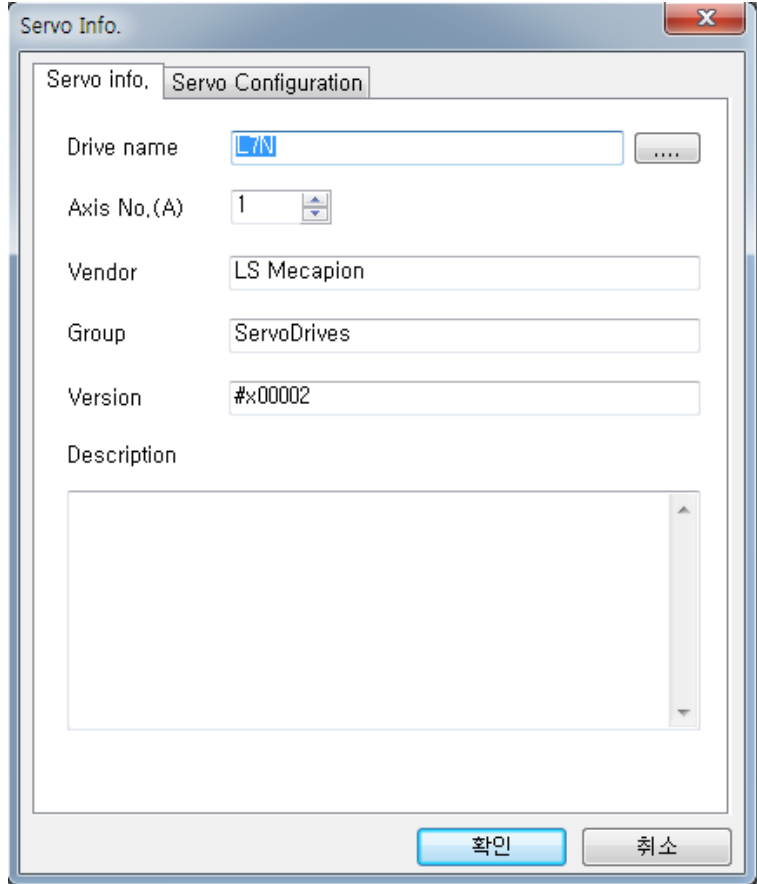

(19) After axis number setting is completed, the added servo driver appears in network parameter.

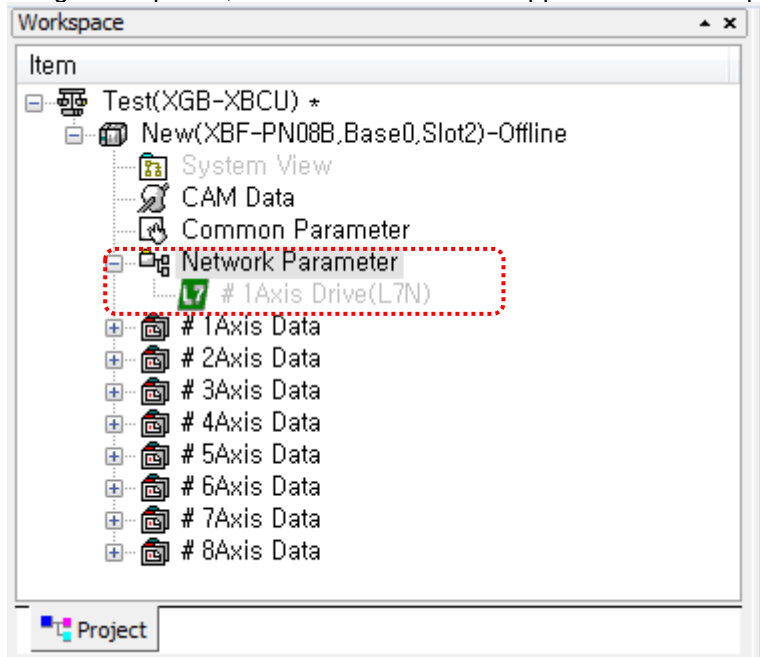

Remark

When the servo drivers are same, you can use “Copy”, “Paste”. After selecting “Copy” menu while first servo driver is added, click the right button and execute “Paste” menu while the cursor is on the network parameter.

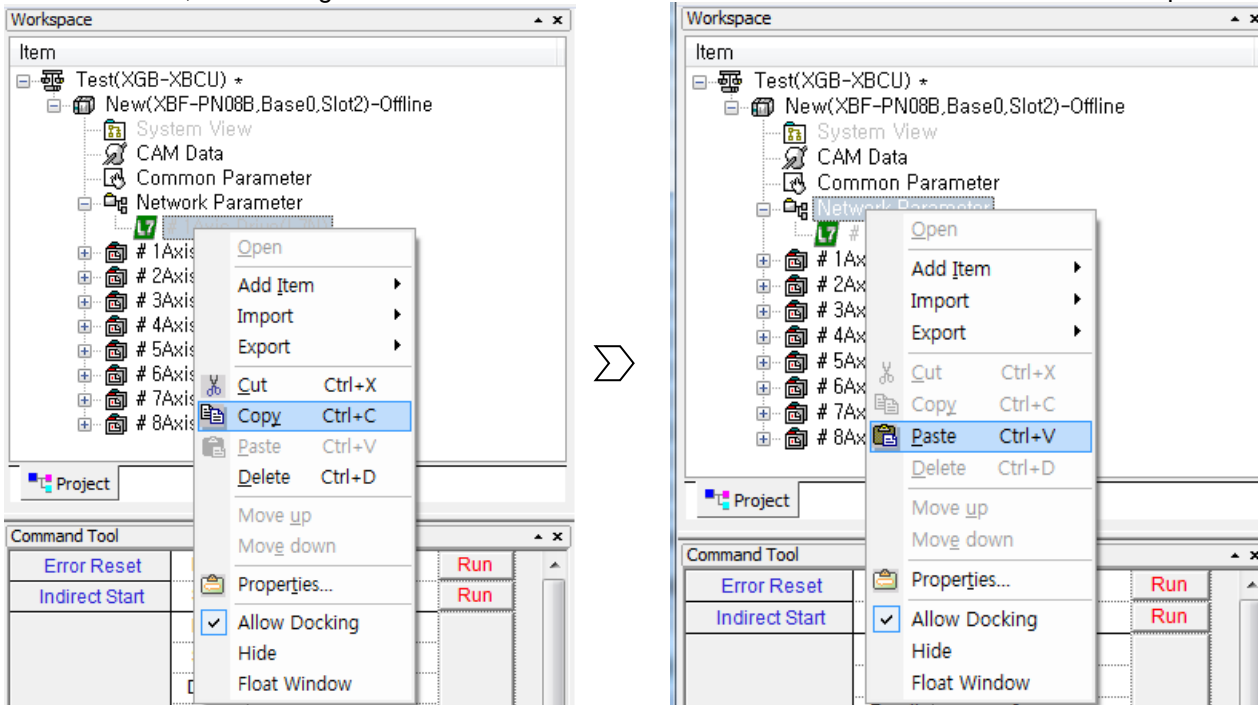

If you do as above, the same servo driver will be added and its axis number will increase by one.

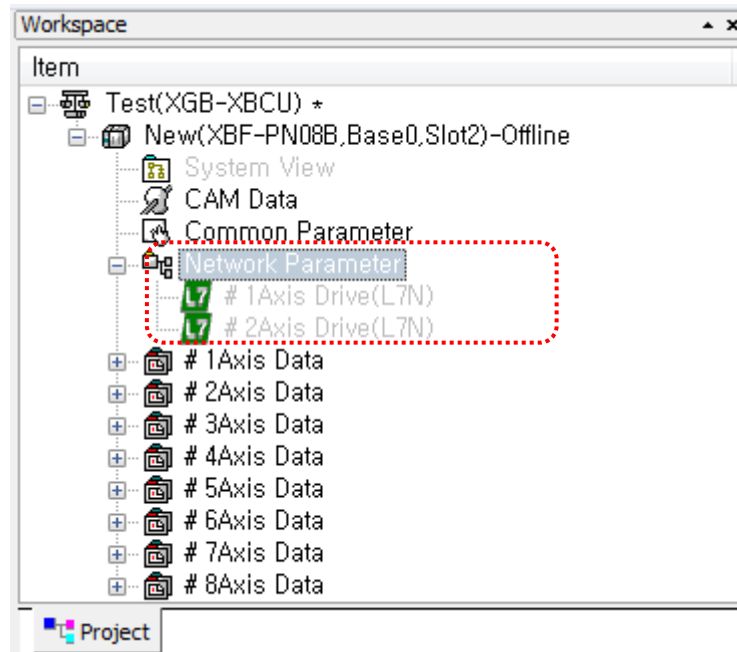

(20) For other servo drivers, add the servo driver equally. The following is the screen where all servo drivers are added. Before connection between positioning module and servo driver is established by “Connect to all servo”, they will be shown with grey color.

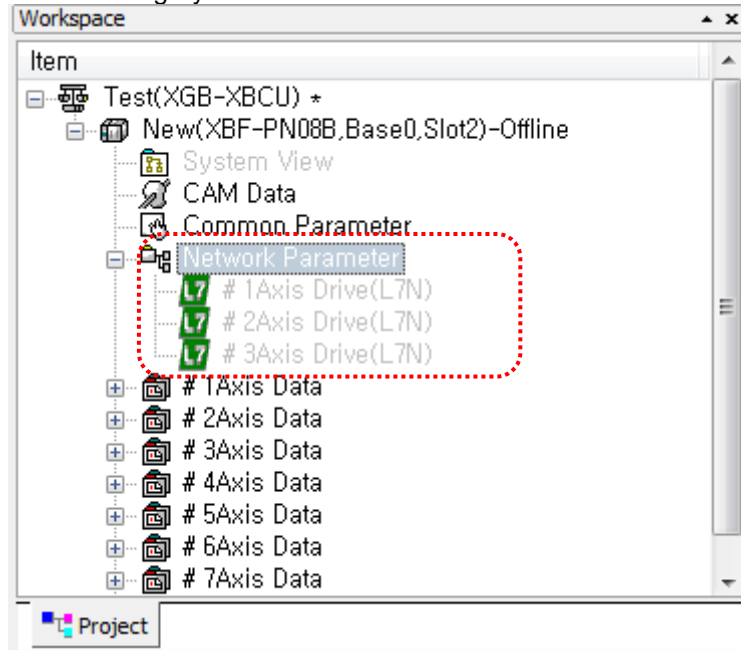

(21) After adding servo drivers, execute “Online-Connect” and execute “Online-Write” to write network parameter to the positioning module.

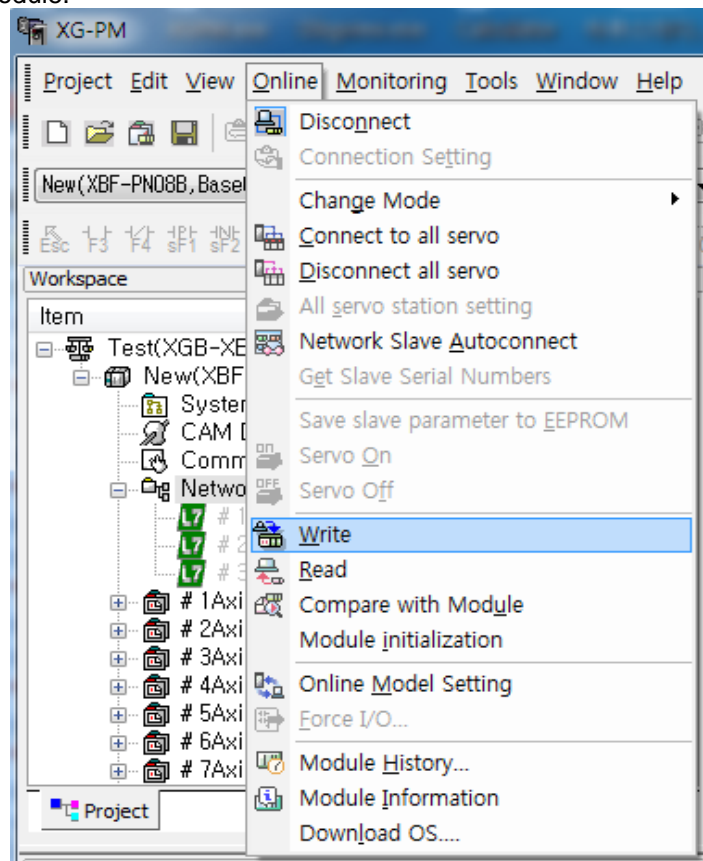

(22) If "Write project" window appears, check "Network Parameter" and click OK. The following is screen from start to completion.

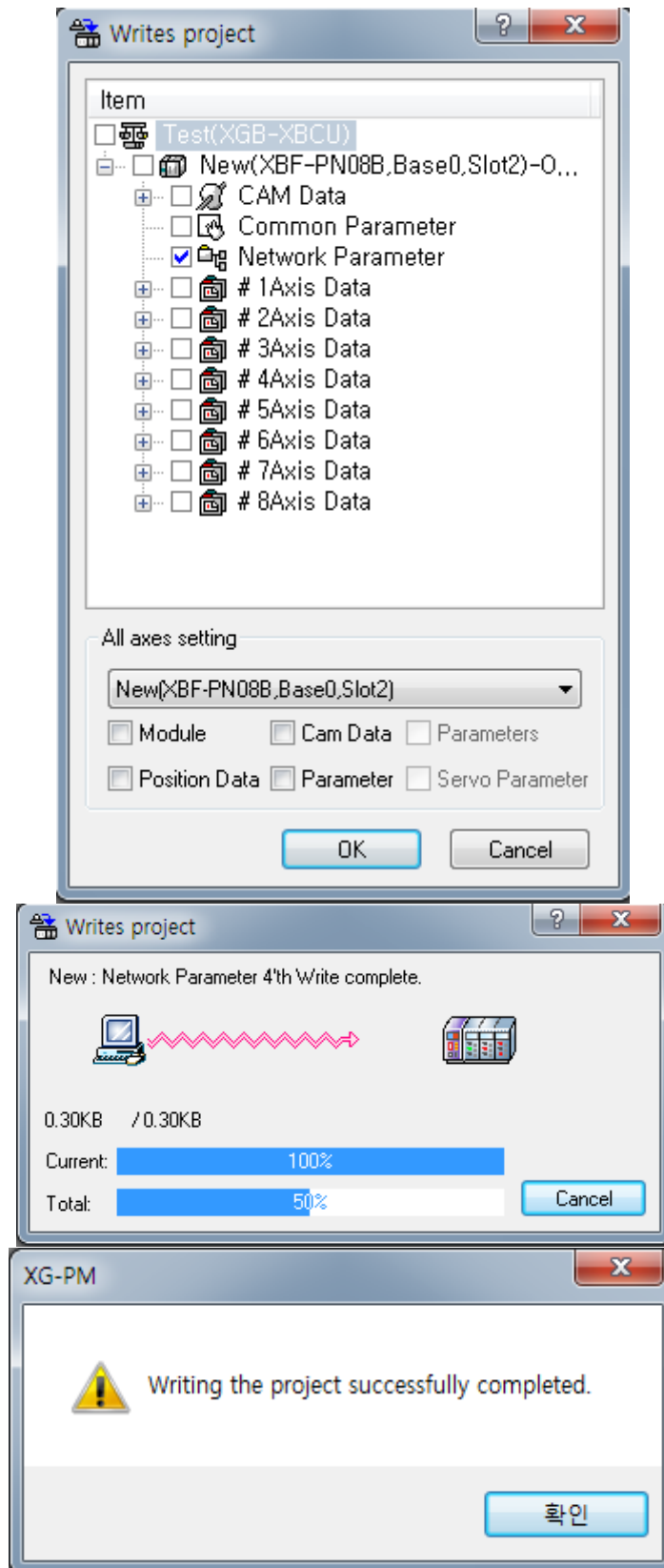

Appendix4 Setting Example

(23) Select "Online – Connect to all servo" and connect the positioning module to the servo drivers.

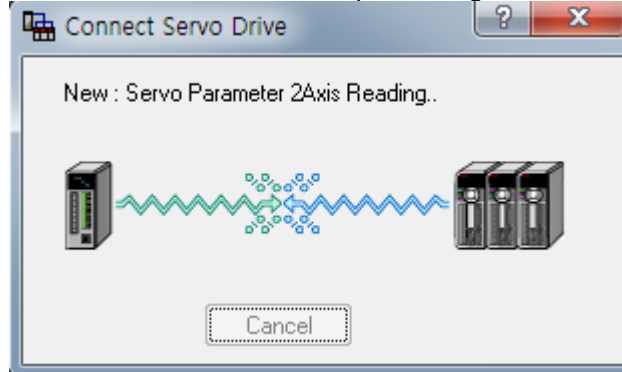

(24) If connection is completed, servo driver name in network parameter is activated and becomes black color from grey color. And in system view window, the actually conneted servo driver is activated.

Network Parameter Tree:

- Test(XGB-XBCU)
 - New(XBF-PN08B.Base0.Slot2)-Online
 - System View
 - CAM Data
 - Common Parameter
 - Network Parameter**
 - # 1Axis Drive(L7N)**
 - # 2Axis Drive(L7N)**
 - # 3Axis Drive(L7N)**
 - # 1Axis Data
 - # 2Axis Data
 - # 3Axis Data
 - # 4Axis Data
 - # 5Axis Data
 - # 6Axis Data
 - # 7Axis Data
 - # 8Axis Data

System View Table:

Item	Contents
Information	XBF-PN08B(Base0.Slot2)-Online
OS Info.	Ver. 1.0 (2015- 1-6)
Status	Normal (0)

Command Tool Table:

Item	Rst. Axis Error	Run
Error Reset	Step	0
Indirect Start	Pos.	0 pls
	Spd.	0 pls/s
	Dwell	0 ms
Direct Start	M Code	0
	Accel.	No.1
	Decel.	No.1
	Coord.	ABS
	Type	0: POS
Decel.	Time	0 ms

Message Window Log:

```

2015-02-13 12:11:42:995 New : Connecting to servo drive...
2015-02-13 12:11:43:135 New : Connecting to servo drive...
2015-02-13 12:11:43:213 New : Durrant connected axis are 3 axis.
2015-02-13 12:11:43:369 New : Servo Parameter 1Axis Reading..
2015-02-13 12:11:45:257 New : Servo Parameter 1Axis Read completed.
2015-02-13 12:11:45:288 New : Servo Parameter 2Axis Reading..
2015-02-13 12:11:47:207 New : Servo Parameter 2Axis Read completed.
2015-02-13 12:11:47:238 New : Servo Parameter 3Axis Reading..
2015-02-13 12:11:49:141 New : Servo Parameter 3Axis Read completed.
2015-02-13 12:11:49:235 New : End connecting to servo drive.
    
```

Remark

1. When connecting to network for the first time after configuring system with XBF-PN04B/PN08B, if you use "Network servo auto connect" function, you can connect conveniently without network parameter setting.

1) Execute "Online – Network servo auto connect" menu.

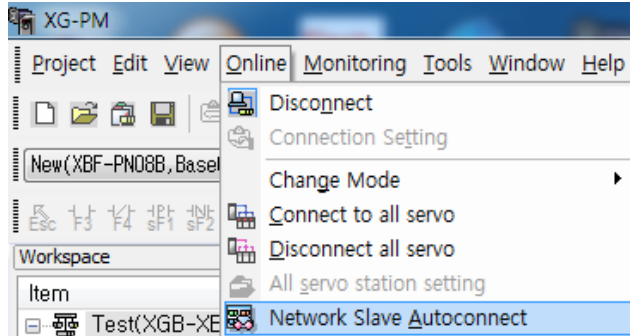

2) The following alarm message appears. If there is network parameter set in XG-PM and positioning module, it will be initialized and servo parameter in XG-PM also will be initialized. Check the message and click OK.

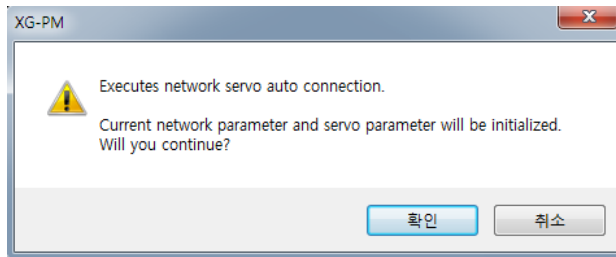

3) The following message appears and if connection is completed normally, completion message appears.

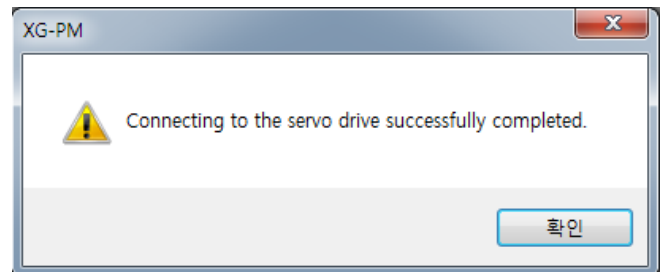
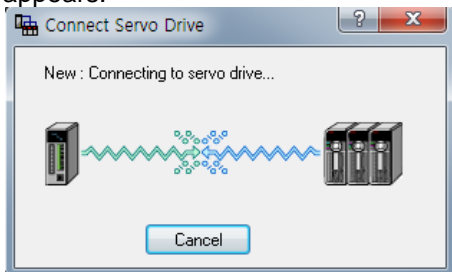

4) If it is completed normally, the currently connected servo driver will be added in network parameter automatically.

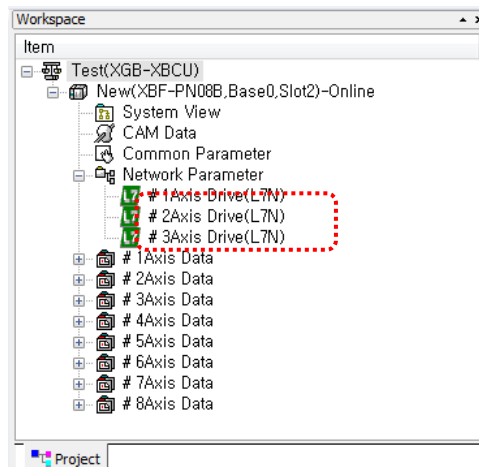

5) Axis number will be assigned automatically according to connection sequence. That is, the first

servo driver becomes 1-axis. If you want to change axis number, disconnect and change axis number and write the network parameter and execute "Online – Connect to all servo".

(25) Read the parameter to set up “operation parameter and servo parameter”.

Select menu “Online - Read” to execute reading.

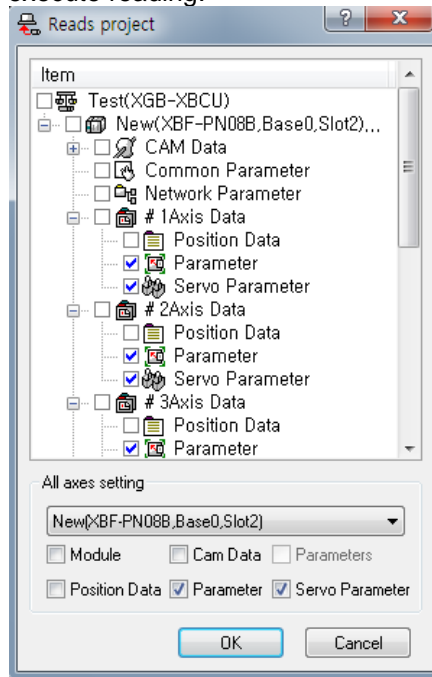

(26) The following is the servo parameter of “SanyoDenki”. The servo parameter may differ according to servo driver type. For detail, refer to the each servo driver manual.

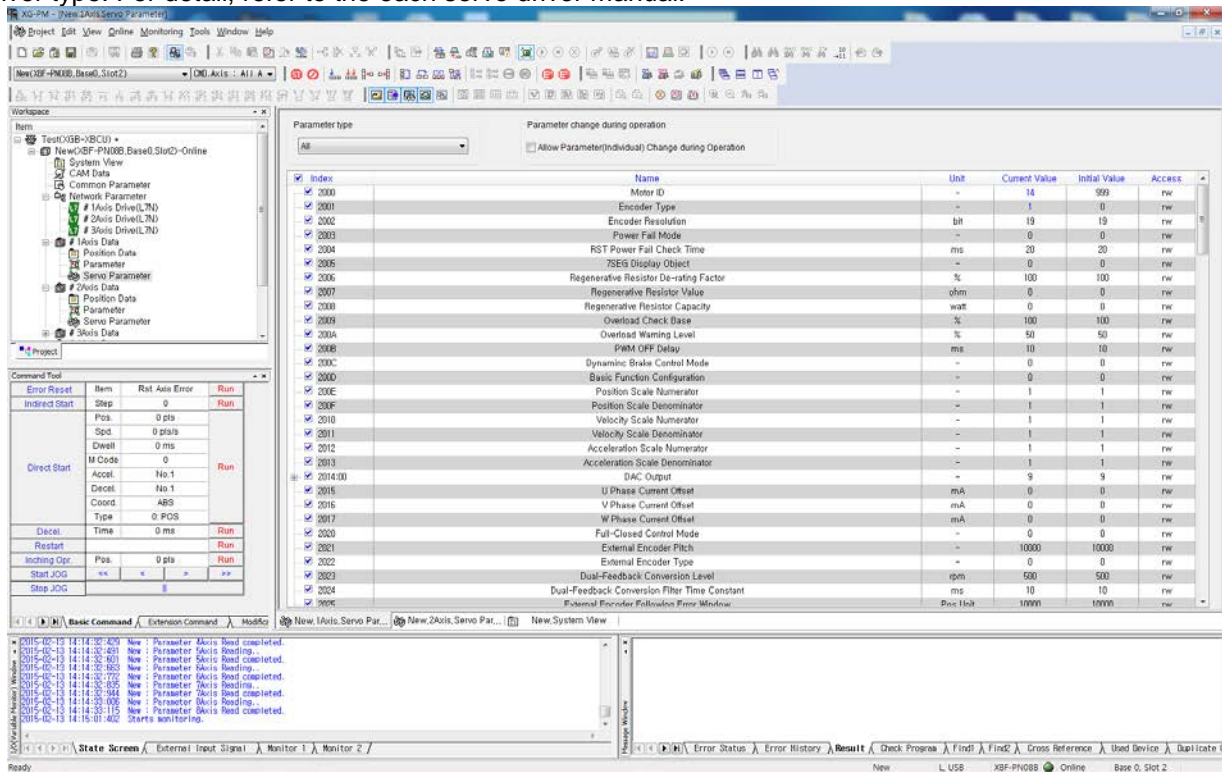

(27) You can set up servo parameter with two methods. After selecting “Allow Servo Parameter (Individual) Change During Operation”, if you set up servo parameter and click “Enter key”, that is applied to the servo driver instantly. If the changed is applied to “Current Value” normally, the value has been transmitted normally.

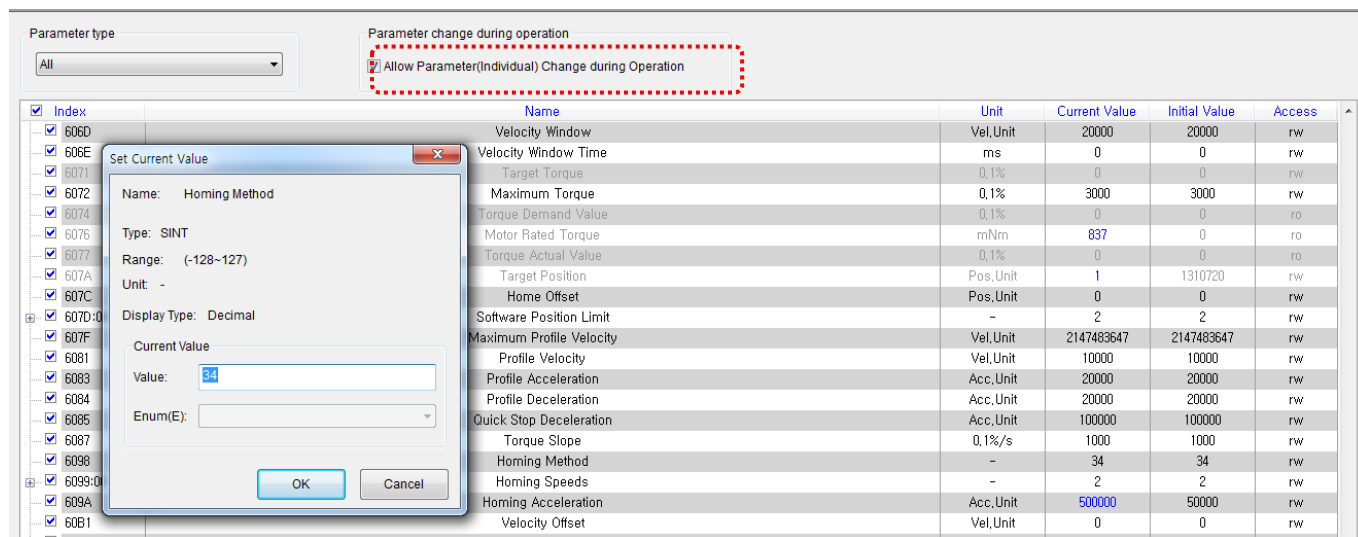

In case of change by “Allow Servo Parameter (Individual) Change During Operation”, that is effective only when power is applied. In order to keep the servo driver data after On/Off, you have to execute “Online – Save servo parameter to EEPROM”

As a second method, after setting all servo parameters, execute “Online – Write” to write all servo parameters once.

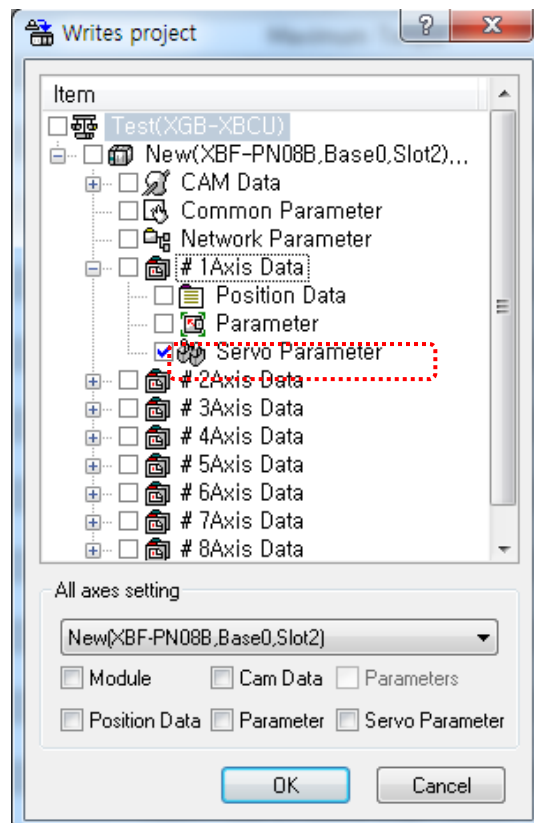

In case of method above, “Save servo parameter to EEPROM” command is executed automatically. So you don’t need to execute “Save servo parameter to EEPROM” command. According to servo parameter, you may have to restart servo driver to apply the change. Refer to the servo driver manual.

(28) After servo parameter setting is finished, set up parameter and write it to the module by selecting “Online – Write”.

Appendix4 Setting Example

The screenshot displays a software interface for configuring servo parameters. On the left, a 'Workspace' tree shows a project named 'Test(XGB-XBCU) *' with sub-items for 'System View', 'CAM Data', 'Common Parameter', 'Network Parameter', and three drive configurations: '# 1Axis Drive(L7N)', '# 2Axis Drive(L7N)', and '# 3Axis Drive(L7N)'. Below the workspace is a 'Command Tool' with buttons for 'Error Reset', 'Indirect Start', 'Direct Start', 'Decel.', 'Restart', 'Inching Opr.', and 'Start JOG', along with a 'Run' button. The main area is a parameter table with columns for 'Item', '1 Axis', '2 Axis', and '3 Axis'. The table is divided into 'Basic Parameter' and 'Extended Parameter' sections. A 'New Parameter' button is highlighted with a red dashed box at the bottom right.

Item	1 Axis	2 Axis	3 Axis
Unit	0: pulse	0: pulse	0: pulse
Pulses per rotation	131072 pls	131072 pls	131072 pls
Travel per rotation	20000 pls	20000 pls	20000 pls
Unit multiplier	0: x1	0: x1	0: x1
Speed command unit	0: Unit/Time	0: Unit/Time	0: Unit/Time
Speed limit	6000000 pls/s	6000000 pls/s	6000000 pls/s
Acc. time1	500 ms	500 ms	500 ms
Acc. time2	1000 ms	1000 ms	1000 ms
Acc. time3	1500 ms	1500 ms	1500 ms
Acc. time4	2000 ms	2000 ms	2000 ms
Dec. time 1	500 ms	500 ms	500 ms
Dec. time 2	1000 ms	1000 ms	1000 ms
Dec. time 3	1500 ms	1500 ms	1500 ms
Dec. time 4	2000 ms	2000 ms	2000 ms
Dec. time for emg. stop	0 ms	0 ms	0 ms
Encoder select	0: Incremental Encoder	0: Incremental Encoder	0: Incremental Encoder
Cur. pos. compensation amount	0 pls	0 pls	0 pls
S/W upper limit	2147483647 pls	2147483647 pls	2147483647 pls
S/W lower limit	-2147483648 pls	-2147483648 pls	-2147483648 pls
Infinite running repeat. pos.	36000000 pls	36000000 pls	36000000 pls
Infinite running repeat.	0: Disable	0: Disable	0: Disable
Position completion time	1000 ms	1000 ms	1000 ms
S-Curve ratio	50 %	50 %	50 %
In-Position width	0 pls	0 pls	0 pls
Acc./Dec. pattern	0: Trapezoid	0: Trapezoid	0: Trapezoid
M code mode	0: None	0: None	0: None
Software limit detect	0: Don't detect	0: Don't detect	0: Don't detect
Ext. command selection	0: External VTP	0: External VTP	0: External VTP
Ext. command	0: Disable	0: Disable	0: Disable
Position complete condition	0: Dwell	0: Dwell	0: Dwell
Int. continuous opr. type	0: Pass target pos.	0: Pass target pos.	0: Pass target pos.
Int. speed selection	0: Main Ax Spd.	0: Main Ax Spd.	0: Main Ax Spd.
Arc insertion position	0 pls	0 pls	0 pls
Arc insertion	0: Don't insert	0: Don't insert	0: Don't insert

(29) If you restart the servo driver in step (27), execute “Online – connect to all servo” again to connect the module to the servo driver.

(30) After selecting command axis and executing “servo on”, check “servo on” status. And execute JOG and etc to check whether the motor operates or not.

The screenshot shows the XG-PM software interface. The top menu bar includes Project, Edit, View, Online, Monitoring, Tools, Window, and Help. The main workspace displays a diagram of a servo system with three axes labeled A1, A2, and A3. A table in the top right corner shows system information: XBF-PN08B(Base0,Slot2)-Online, Ver. 1.0 (2015- 1- 6), and Status Normal (0). Below the diagram is a data table with columns for Status / Axis and rows for various parameters like Pos/Spd Unit, Command Pos, Current Pos, Torque, Step No., Error Code, Main Axis, and Origin Fix. The Origin Fix row shows 'ON' for all three axes. At the bottom left, a Command Tool window is open, showing various control options like Error Reset, Indirect Start, Direct Start, Decel., Restart, Inching Opr., Start JOG, and Stop JOG. Red dashed boxes and numbered circles (1-5) highlight specific areas: (1) points to the 'CMD.Axis: All A' dropdown; (2) points to the 'Servo On' button; (3) points to the 'A1' servo status indicator; (4) points to the 'Start JOG' button; and (5) points to the 'Command Pos' row in the data table.

Item	Contents
Information	XBF-PN08B(Base0,Slot2)-Online
OS Info.	Ver. 1.0 (2015- 1- 6)
Status	Normal (0)

Status / Axis	1 Axis	2 Axis	3 Axis	4 Axis	5 Axis	6 Axis	7 Axis	8 Axis
Pos/Spd Unit	pls,pls/s	pls,pls/s	pls,pls/s					
Command Pos.	-126	-214	87					
Command Spd.	0	0	0					
Current Pos.	-127	-214	88					
Current Spd.	-500	0	0					
Torque	0.5 %	1.0 %	0.2 %					
Step No.	1	1	1					
Error Code	0	0	0					
Main Axis	1 Axis	2 Axis	3 Axis					
Main/Sub. Ax.	Main Axis	Main Axis	Main Axis					
M Code	0	0	0					
Opr. Status								
Pos. Comp.								
M Code ON								
Origin Fix	ON	ON	ON					
Ctrl Pattern								
Stop Status								
Upper Limit								
Lower Limit								

Command Tool	Item	Rst. Axis Error	Run
Error Reset	Item	Rst. Axis Error	Run
Indirect Start	Step	0	Run
Direct Start	Pos.	0 pls	Run
	Spd.	0 pls/s	
	Dwell	0 ms	
	M Code	0	
	Accel.	No.1	
	Decel.	No.1	
Coord.	ABS		
Decel.	Time	0 ms	Run
Restart			Run
Inching Opr.	Pos.	0 pls	Run
Start JOG			
Stop JOG			

(31) If vibration or noise occurs when operating the motor, adjust response, inertia ratio and etc. in servo parameter and send to the servo driver.

(25) Write PLC program through XG5000

(a) Create new project. After selecting menu "Project-New Project", set up project name.

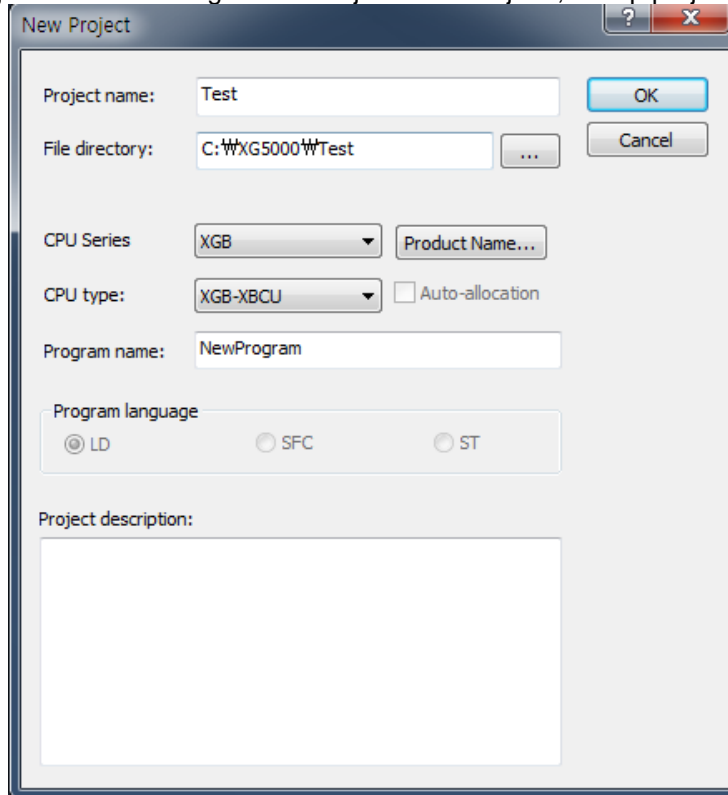

(b) Disconnect XG-PM from PLC CPU. If you connect to XG5000 while XG-PM is connected in XGK CPU, the following dialog box appears and PLC function is limited. If you connect XG-PM after connecting XG5000, that problem will not occur.

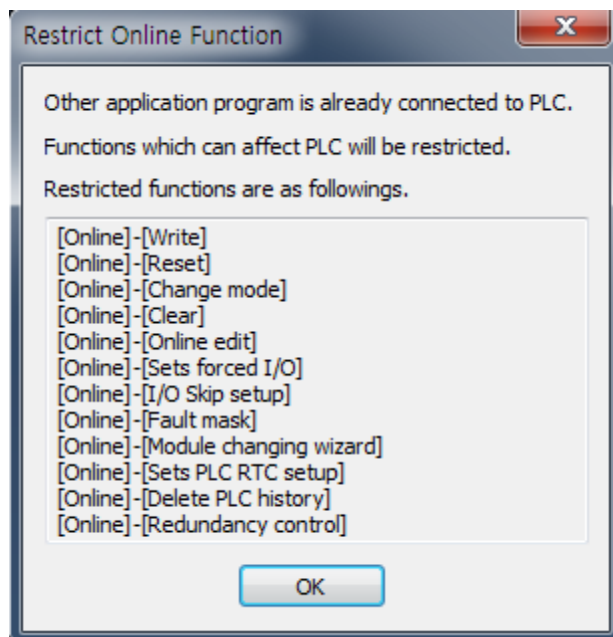

- (c) Select "Online - Connection Settings" to set up connection setting and select "Online – Connect" to connect to PLC CPU.
- (d) Change PLC PU mode to "STOP".
- (e) "Select "Online – I/O information" and check the current I/O information of PLC.

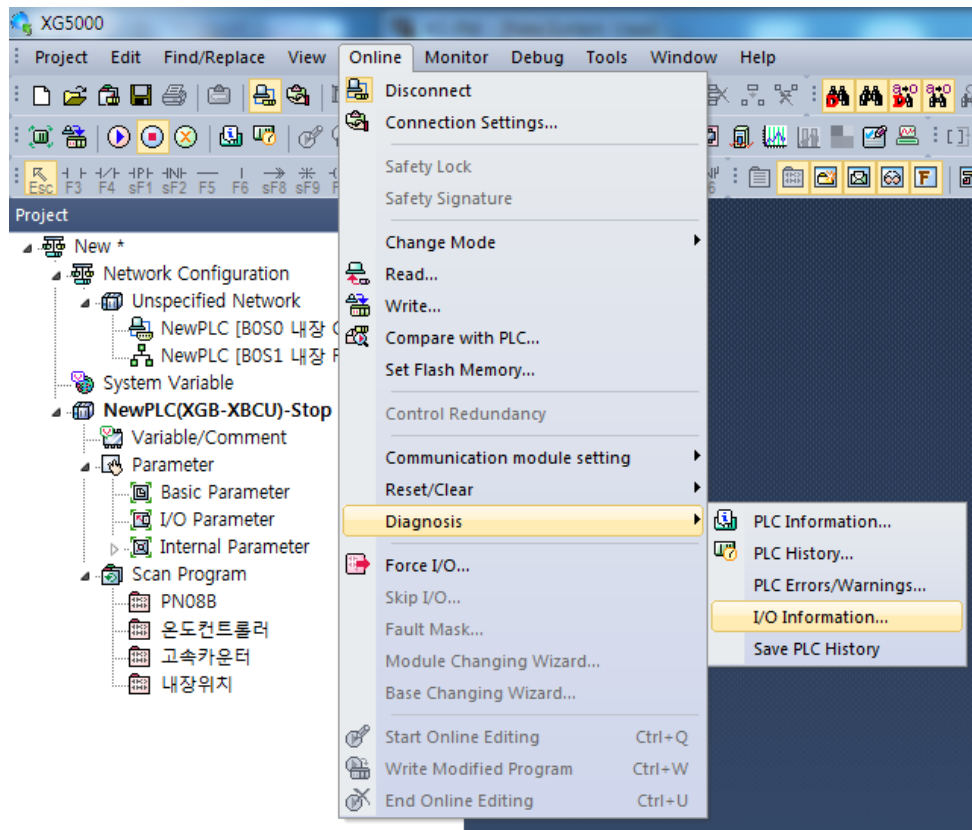

(f) In I/O information window, check whether XBF-PN08B information is shown correctly. If you want to see version of the module, click “Details”.

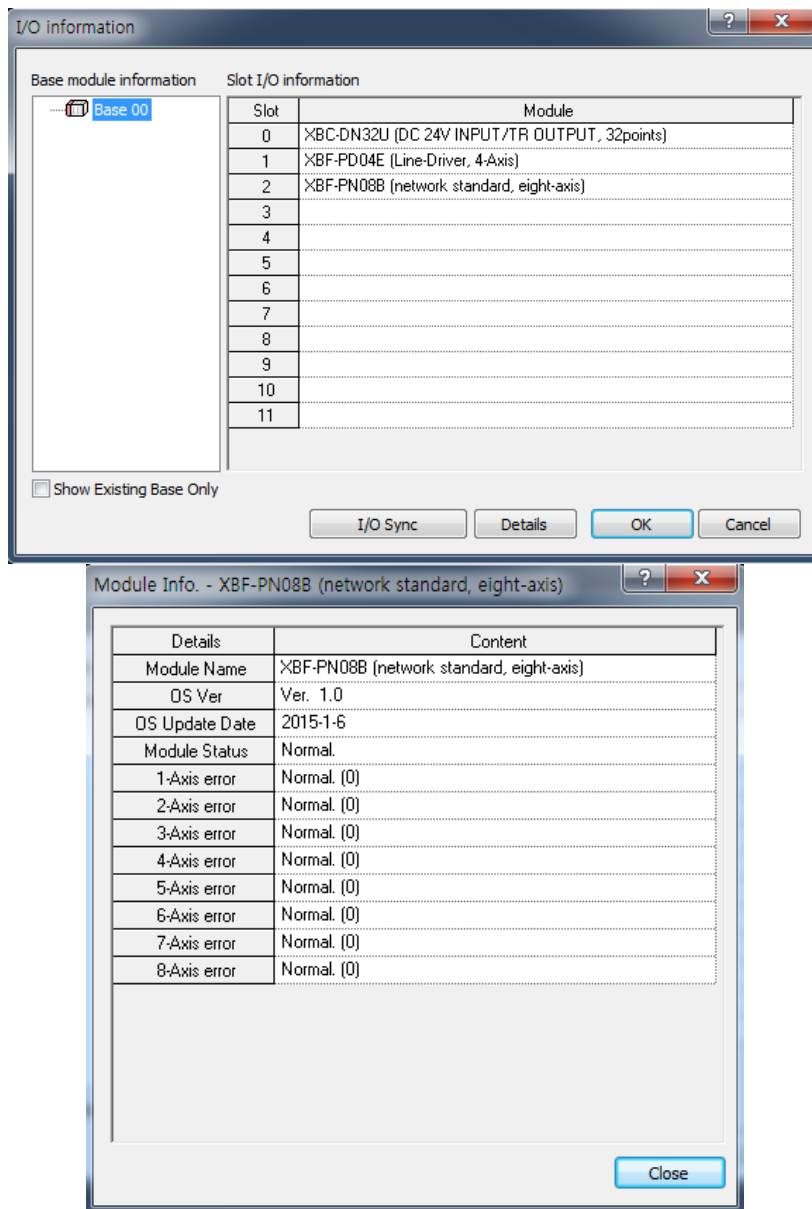

(g) In I/O information window, click “I/O Sync.” button to set up I/O parameter.

(h) Select “Edit- Register U device” to register U device.

(i) In the following example, XGK CPU and two servos are used. Those servos are set as 1-axis and 2-axis. It connects by using XECON and reads status information of the connected axis. Add other programs as necessary.

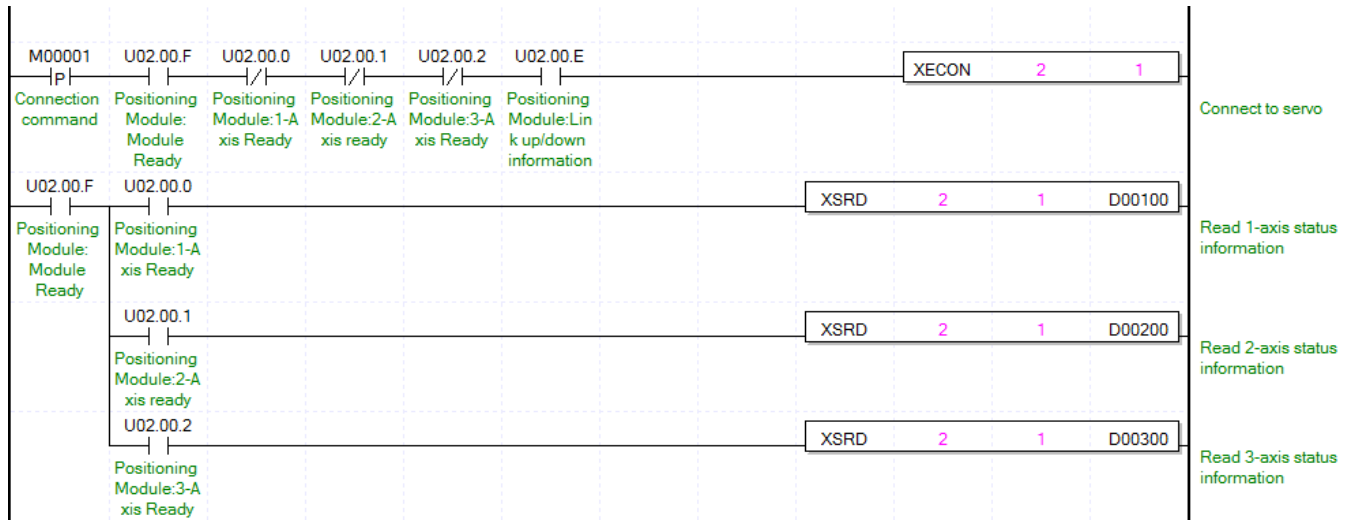

Appendix5. Setting the Virtual Axis

It describes how to set up the first time you use the virtual axis function.

1. Prior to the setting of the virtual axis, set the servo drive.

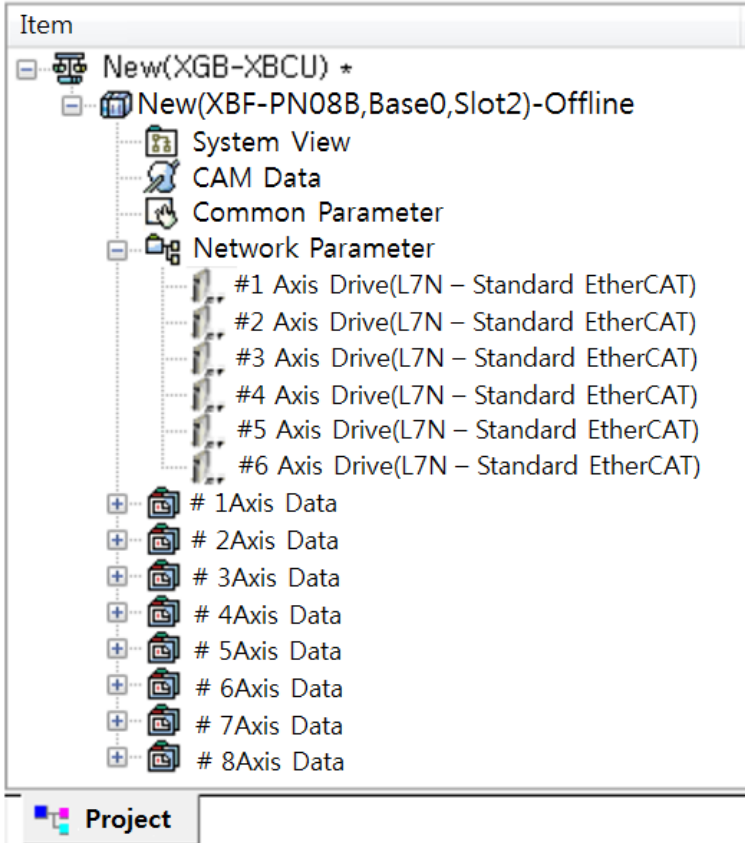

2. Set the virtual axis to the axis that is not being used is connected to the servo drive. Configuration of virtual axis can be set in the default parameters of operating parameters. The virtual axis is recommended to set behind the actual axis. For example, if you are using a servo drive module 6 to XBF-PN08B, 1~6 axis should be set as real-axis and 7~8 must be set as virtual axis.

Within the number of virtual axis control axis, with the exception of the actual axis, all will be normally used.

	Item	6Axis	7Axis	8Axis
Basic Parameter	Axis Type	0: Real Axis	1: Virtual Axis	1: Virtual Axis
	Unit	0: pulse	0: pulse	0: pulse
	Pulse per rotation	524288 pls	524288 pls	524288 pls
	Travel per rotation	20000 pls	20000 pls	20000 pls
	Unit multiplier	0: x1	0: x1	0: x1
	Speed command unit	0: Unit/Time	0: Unit/Time	0: Unit/Time
	Speed limit	20000000 pls/s	20000000 pls/s	20000000 pls/s
	Acc. time1	500 ms	500 ms	500 ms
	Acc. time2	1000 ms	1000 ms	1000 ms
	Acc. time3	1500 ms	1500 ms	1500 ms
	Acc. time4	2000 ms	2000 ms	2000 ms
	Dec. time1	500 ms	500 ms	500 ms
	Dec. time2	1000 ms	1000 ms	1000 ms
	Dec. time3	1500 ms	1500 ms	1500 ms
	Dec. time4	2000 ms	2000 ms	2000 ms
	Dec. time for emg. stop	0 ms	0 ms	0 ms
	Encoder select	0: Incremental Encoder	0: Incremental Encoder	0: Incremental Encoder
	Cur. Pos. compensation amount	0 pls	0 pls	0 pls
	User defined position display magnification	0	0	0
	User defined speed display magnification	0	0	0

3. Once the setup is complete, the network parameters and operating parameters to run the project write access to the PLC and communications. Setting of the virtual axis, has become to be set because the operating parameters.

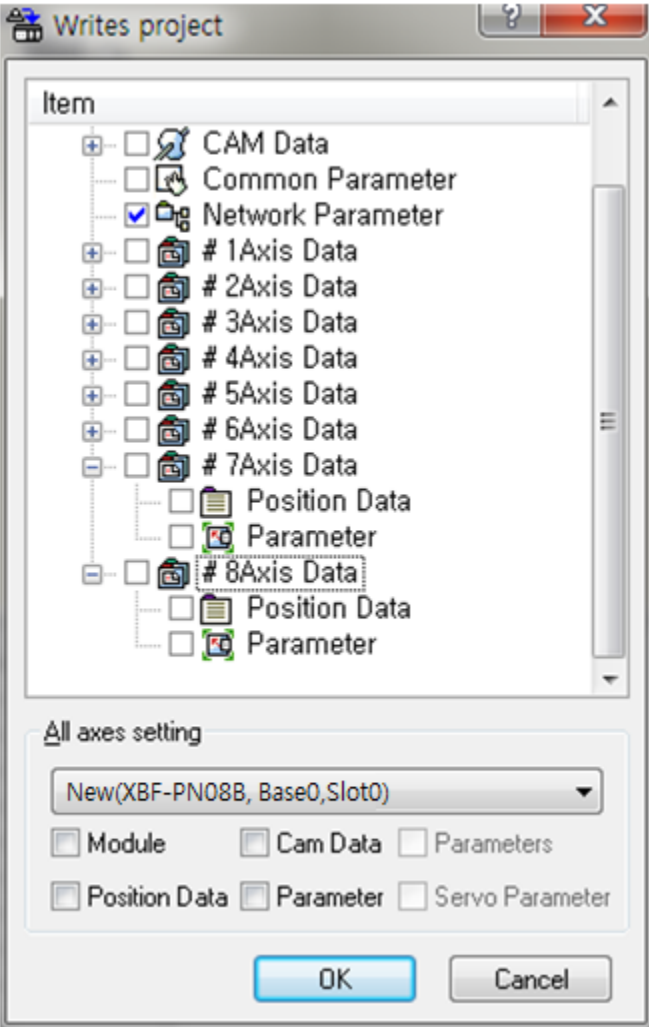

Appendix5 Setting the Virtual Axis

4. Run a network connection to ensure that the connection is normal for the real-axis and virtual-axis. If user set a virtual axis as the real axis, the axis error 5031 when a network connection.

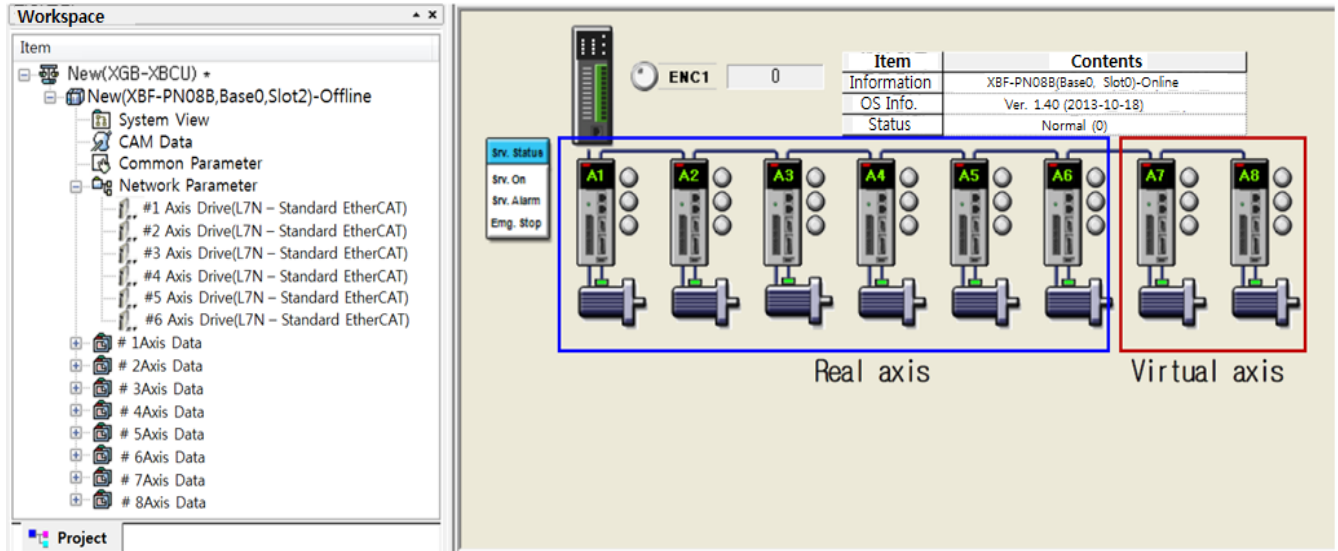

5. Commands that doesn't support virtual axis is as follows. Except for the following commands it can be used in the same way as real-axis.

Command does not support the virtual axis	XBC Command	XEC FB
Position / torque control switch	XPTT	XPM_PTT
External position / torque control switching Torque	XSEST	XPM_SIPT
Read servo error information	-	XPM_SVERD
Reset servo error	XSCLR	XPM_SRST
Reset servo error history	XSECLR	XPM_SHRST
Read the servo drive parameters	XSVPRD	XPM_SVPRD
Write the servo drive parameters	XSVPWR	XPM_SVPWR
Save the servo drive parameters	XSVSAVE	XPM_SVSAVE
Torque control	XTRQ	XPM_TRQ
Read latch position data	XLRD	XPM_LRD
Reset latch	XLCLR	XPM_LCLR
Latch Set	XLSET	XPM_LSET
Torque synchronous	XSTC	XPM_STC

6. Version information that supports the virtual axis is as follows.

Item	Support version
XG5000	More than V4.09
XBF-PN04B	More than V1.20
XBF-PN08B	More than V1.20

Warranty

1. Warranty Period

The product you purchased will be guaranteed for 18 months from the date of manufacturing.

2. Scope of Warranty

Any trouble or defect occurring for the above-mentioned period will be partially replaced or repaired. However, please note the following cases will be excluded from the scope of warranty.

- (1) Any trouble attributable to unreasonable condition, environment or handling otherwise specified in the manual,
- (2) Any trouble attributable to others' products,
- (3) If the product is modified or repaired in any other place not designated by the company,
- (4) Due to unintended purposes
- (5) Owing to the reasons unexpected at the level of the contemporary science and technology when delivered.
- (6) Not attributable to the company; for instance, natural disasters or fire

3. Since the above warranty is limited to PLC unit only, make sure to use the product considering the safety for system configuration or applications.

Environmental Policy

LS ELECTRIC Co., Ltd supports and observes the environmental policy as below.

Environmental Management

LS ELECTRIC considers the environmental preservation as the preferential management subject and every staff of LS ELECTRIC use the reasonable endeavors for the pleasurable environmental preservation of the earth.

About Disposal

LS ELECTRIC' PLC unit is designed to protect the environment. For the disposal, separate aluminum, iron and synthetic resin (cover) from the product as they are reusable.



www.lselectric.co.kr

LS ELECTRIC Co., Ltd.

■ Headquarter

LS-ro 127(Hogye-dong) Dongan-gu, Anyang-si, Gyeonggi-Do, 14119, Korea

■ Seoul Office

LS Yongsan Tower, 92, Hangang-daero, Yongsan-gu, Seoul, 04386, Korea
Tel: 82-2-2034-4033, 4888, 4703 Fax: 82-2-2034-4588
E-mail: automation@lselectric.co.kr

■ Factory

56, Samseong 4-gil, Mokcheon-eup, Dongnam-gu, Cheonan-si, Chungcheongnam-do, 31226, Korea

■ Overseas Subsidiaries

- **LS ELECTRIC Japan Co., Ltd. (Tokyo, Japan)**
Tel: 81-3-6268-8241 E-Mail: jschuna@lselectric.biz
- **LS ELECTRIC (Dalian) Co., Ltd. (Dalian, China)**
Tel: 86-411-8730-6495 E-Mail: jiheo@lselectric.com.cn
- **LS ELECTRIC (Wuxi) Co., Ltd. (Wuxi, China)**
Tel: 86-510-6851-6666 E-Mail: sblee@lselectric.co.kr
- **LS ELECTRIC Shanghai Office (China)**
Tel: 86-21-5237-9977 E-Mail: tsjun@lselectric.com.cn
- **LS ELECTRIC Vietnam Co., Ltd.**
Tel: 84-93-631-4099 E-Mail: jhchoi4@lselectric.biz (Hanoi)
Tel: 84-28-3823-7890 E-Mail: sjbaik@lselectric.biz (Hochiminh)
- **LS ELECTRIC Middle East FZE (Dubai, U.A.E.)**
Tel: 971-4-886-5360 E-Mail: salesme@lselectric.biz
- **LS ELECTRIC Europe B.V. (Hoofddorf, Netherlands)**
Tel: 31-20-654-1424 E-Mail: europartner@lselectric.biz
- **LS ELECTRIC America Inc. (Chicago, USA)**
Tel: 1-800-891-2941 E-Mail: sales.us@lselectricamerica.com

LS ELECTRIC  Technical Question or After-sales Service
Customer Center - Quick Responsive Service, Excellent technical support
TEL. 82-1644-5481 | www.lselectric.co.kr

Specifications in this instruction manual are subject to change without notice due to continuous products development and improvement.