

F
E
D
C
B
A

1 2 3 4 5 6 7 8

| 소요 수 | QTY | 품번 | 품명 | 재질 | 규격 및 도번 | 비고 |
|------|-----|------|-------------|----------|---------------|--------|
| | | ITEM | DESCRIPTION | MATERIAL | SPECIFICATION | REMARK |
| | | | | | | |

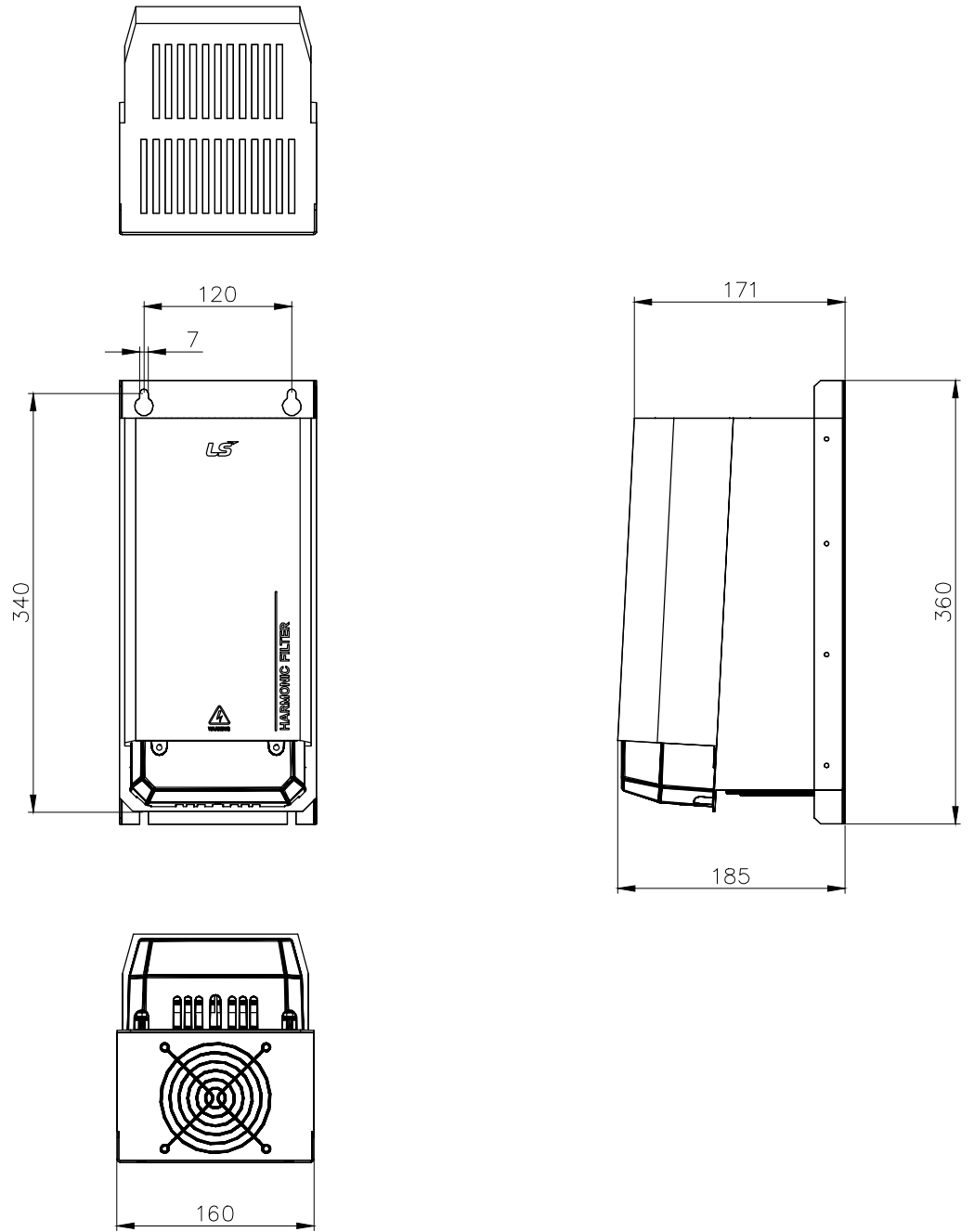

| 적용 제품 Applied Model | |
|------------------------|--|
| HFS-0002-5-60 | |
| HFS-0004-5-60 | |
| HFS-0003-3-50 | |
| HFS-0005-3-50 | |

정
계
CHANGE

| | | | | | | |
|----------------------------------|-----------------|------------------|-----------------|------------------------|------------------------------------------------|---------------|
| LS ELECTRIC | | | | HARMONIC FILTER Series | | 매 수 SHEETS |
| 삼 각 법 3RD ANGLE PROJECTION | 척 도 SCALE | 단 위 DIMENSION | 작 성 일 DATE | 도 면 명 칭 TITLE | HFS EXTERNAL DIMENSION DRAWING FRAME SIZE A | 1 1 |
| 제 도 DRAWN | 설 계 DESIGNED | 검 도 CHECKED | 승 인 APPROVED | 도 면 번 호 DWG. NO. | | |
| | | | | 관 련 도 번 REF. NO. | | |

F
E
D
C
B
A

1 2 3 4 5 6 7 8

| 소요 수 | QTY | 품번 | 품명 | 재질 | 규격 및 도번 | 비고 |
|------|-----|------|-------------|----------|---------------|--------|
| | | ITEM | DESCRIPTION | MATERIAL | SPECIFICATION | REMARK |
| | | | | | | |

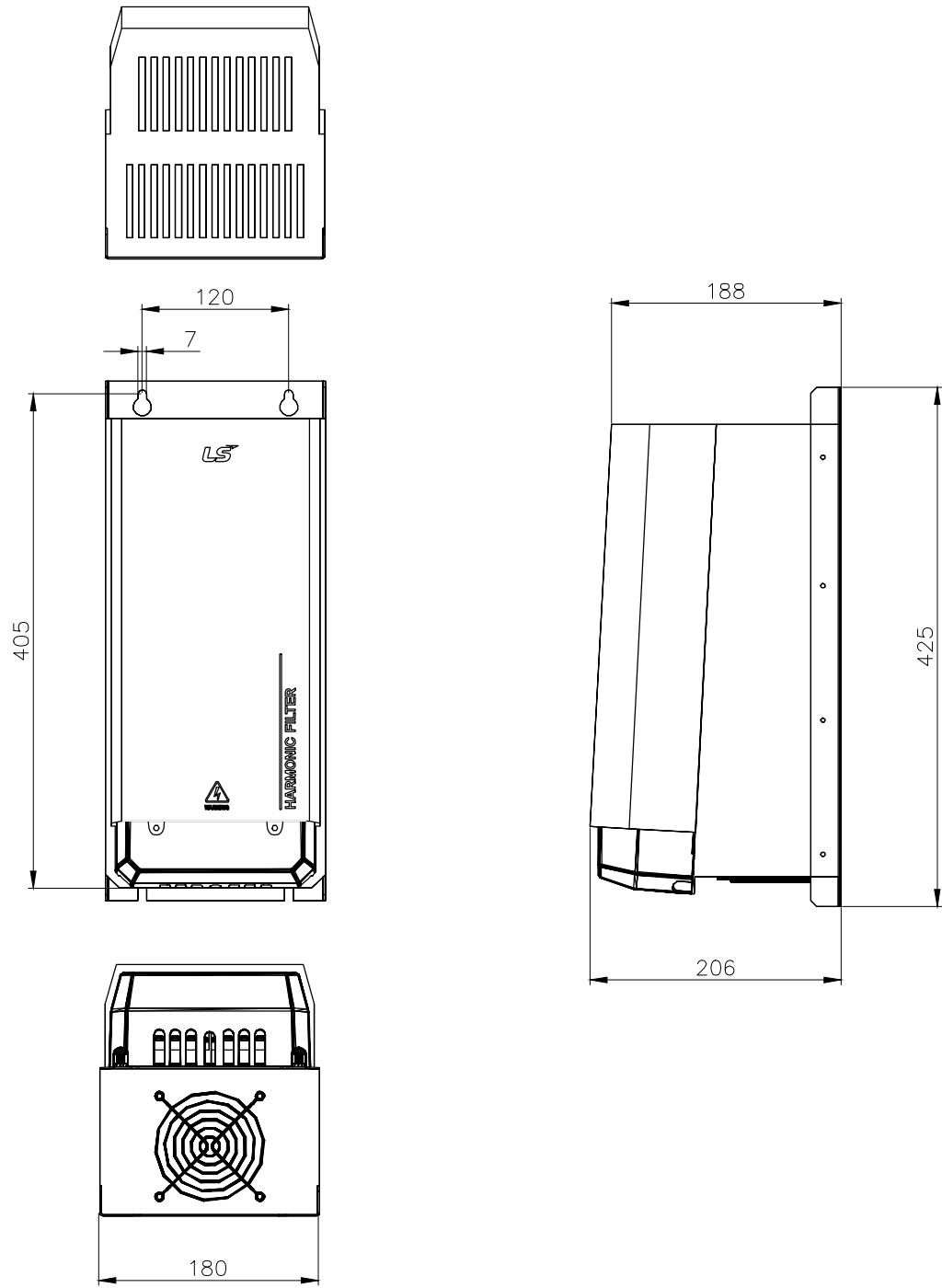

| 적용 제품 Applied Model | |
|------------------------|--|
| HFS-0007-5-60 | |
| HFS-0011-5-60 | |
| HFS-0010-3-50 | |
| | |
| | |

정
개
CHANGE



HARMONIC FILTER Series

매 수
SHEETS

| | | | | | | |
|--------------------------------|---------------|-----------------|---------------|------------------|------------------------------------------------|--------|
| 삼각법 3RD ANGLE PROJECTION | 척도 SCALE | 단위 DIMENSION | 작성일 DATE | 도면명칭 TITLE | HFS EXTERNAL DIMENSION DRAWING FRAME SIZE B | 1 1 |
| 제 DRAWN | 설 DESIGNED | 계 CHECKED | 승 APPROVED | 도면번호 DWG. NO. | | |
| | | | | 관련도번 REF. NO. | | |

F
E
D
C
B
A

1 2 3 4 5 6 7 8

| 소요 수 | QTY | 품번 | 품명 | 재질 | 규격 및 도번 | 비고 |
|------|-----|------|-------------|----------|---------------|--------|
| | | ITEM | DESCRIPTION | MATERIAL | SPECIFICATION | REMARK |
| | | | | | | |

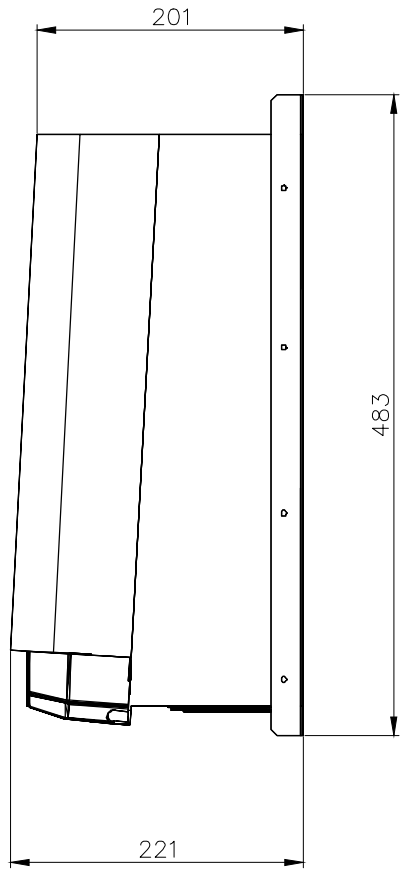
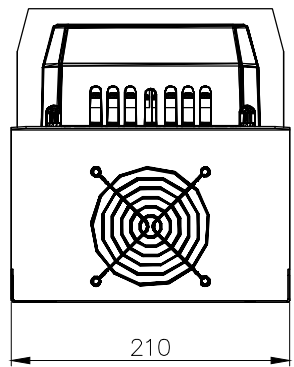
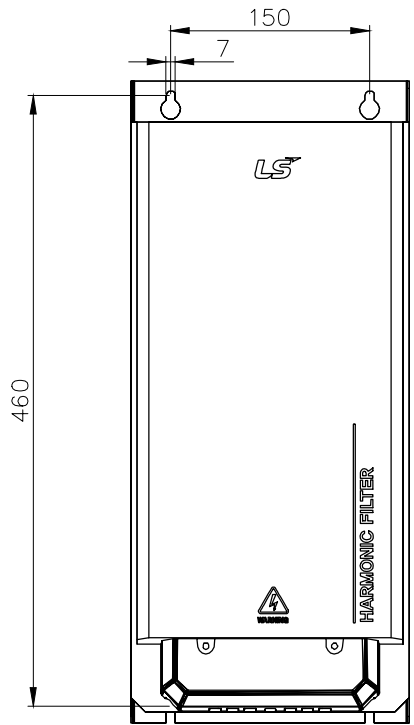
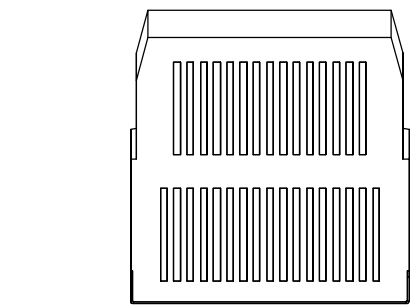

| 적용 제품 Applied Model | |
|------------------------|--|
| HFS-0014-5-60 | |
| HFS-0021-5-60 | |
| HFS-0013-3-50 | |
| HFS-0016-3-50 | |

정
개
CHANGE



HARMONIC FILTER Series

매 수
SHEETS

| | | | | | | |
|--------------------------------|----------------|-----------------|----------------|------------------|------------------------------------------------|--------|
| 삼각법 3RD ANGLE PROJECTION | 척도 SCALE | 단위 DIMENSION | 작성일 DATE | 도면명칭 TITLE | HFS EXTERNAL DIMENSION DRAWING FRAME SIZE C | 1 1 |
| 제도 DRAWN | 설계 DESIGNED | 검토 CHECKED | 승인 APPROVED | 도면번호 DWG. NO. | | |
| | | | | 관련도번 REF. NO. | | |

F
E
D
C
B
A

1 2 3 4 5 6 7 8

| 소요 수 | QTY | 품번 | 품명 | 재질 | 규격 및 도번 | 비고 |
|------|-----|------|-------------|----------|---------------|--------|
| | | ITEM | DESCRIPTION | MATERIAL | SPECIFICATION | REMARK |
| | | | | | | |

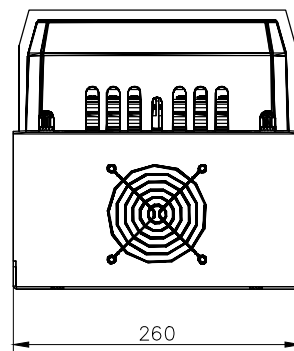
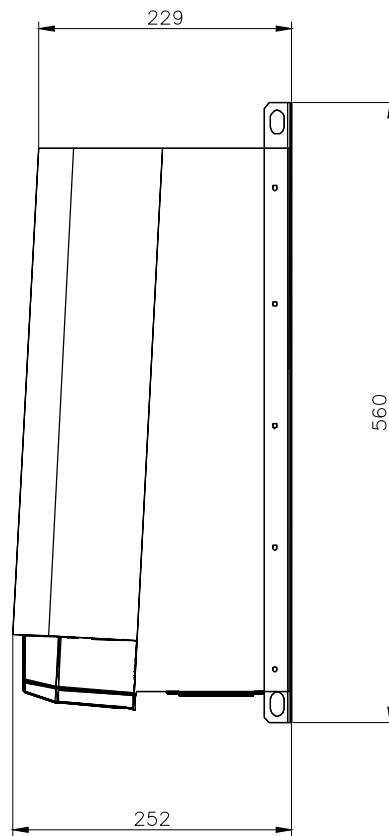
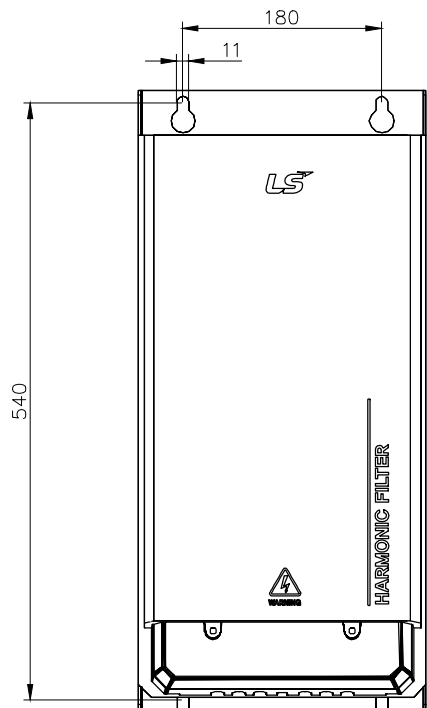
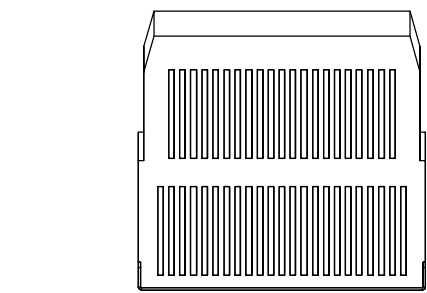

| 적용 제품 Applied Model | |
|------------------------|---------------|
| HFS-0027-5-60 | HFS-0038-3-50 |
| HFS-0034-5-60 | |
| HFS-0044-5-60 | |
| HFS-0024-3-50 | |
| HFS-0032-3-50 | |

정
개
CHANGE



HARMONIC FILTER Series

매 수
SHEETS

| | | | | | | |
|--------------------------------|---------------|-----------------|---------------|---------------|------------------------------------------------|--------|
| 삼각법 3RD ANGLE PROJECTION | 척도 SCALE | 단위 DIMENSION | 작성 DATE | 도면명칭 TITLE | HFS EXTERNAL DIMENSION DRAWING FRAME SIZE D | 1 1 |
| 제 DRAWN | 설 DESIGNED | 계 CHECKED | 도 APPROVED | 승 인 | 도면번호 DWG. NO. | |
| | | | | | 관련도번 REF. NO. | |

F
E
D
C
B
A

1 2 3 4 5 6 7 8

| 소요 수 | QTY | 품번 | 품명 | 재질 | 규격 및 도번 | 비고 |
|------|-----|------|-------------|----------|---------------|--------|
| | | ITEM | DESCRIPTION | MATERIAL | SPECIFICATION | REMARK |
| | | | | | | |

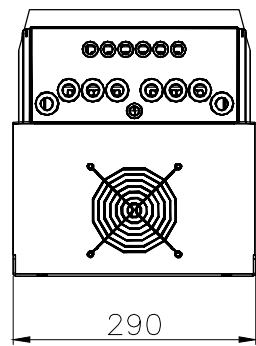
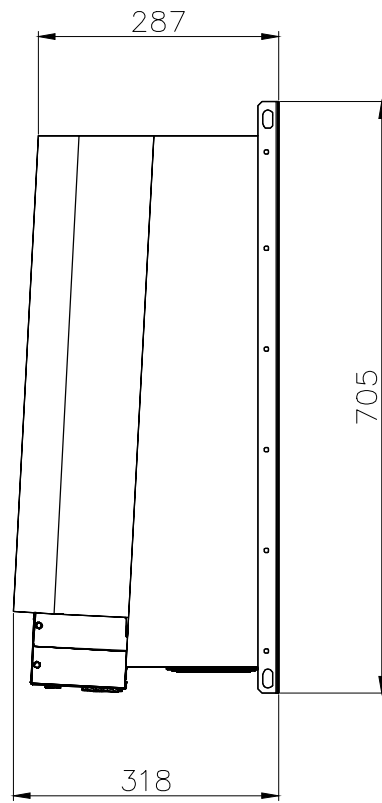
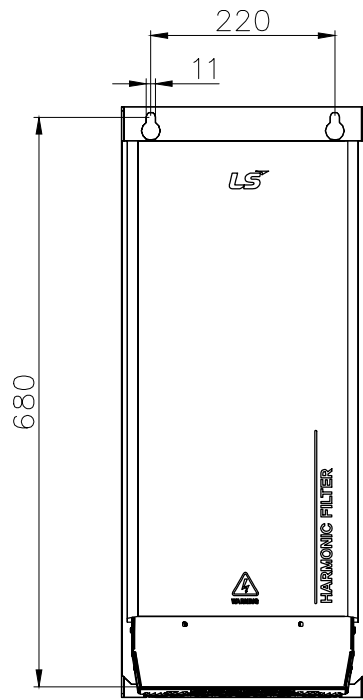
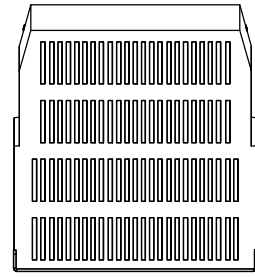

| 적용 제품 Applied Model | |
|------------------------|---------------|
| HFS-0052-5-60 | HFS-0075-3-50 |
| HFS-0066-5-60 | HFS-0090-3-50 |
| HFS-0083-5-60 | HFS-0110-3-50 |
| HFS-0045-3-50 | |
| HFS-0060-3-50 | |

정
개
CHANGE



HARMONIC FILTER Series

매 수
SHEETS

| | | | | | | |
|--------------------------------|---------------|-----------------|---------------|------------------|------------------------------------------------|--------|
| 삼각법 3RD ANGLE PROJECTION | 척도 SCALE | 단위 DIMENSION | 작성일 DATE | 도면명칭 TITLE | HFS EXTERNAL DIMENSION DRAWING FRAME SIZE E | 1 1 |
| 제 DRAWN | 설 DESIGNED | 계 CHECKED | 승 APPROVED | 도면번호 DWG. NO. | | |
| | | | | 관련도번 REF. NO. | | |

F
E
D
C
B
A

1 2 3 4 5 6 7 8

| 소요 수 | QTY | 품번 | 품명 | 재질 | 규격 및 도번 | 비고 |
|------|-----|------|-------------|----------|---------------|--------|
| | | ITEM | DESCRIPTION | MATERIAL | SPECIFICATION | REMARK |
| | | | | | | |

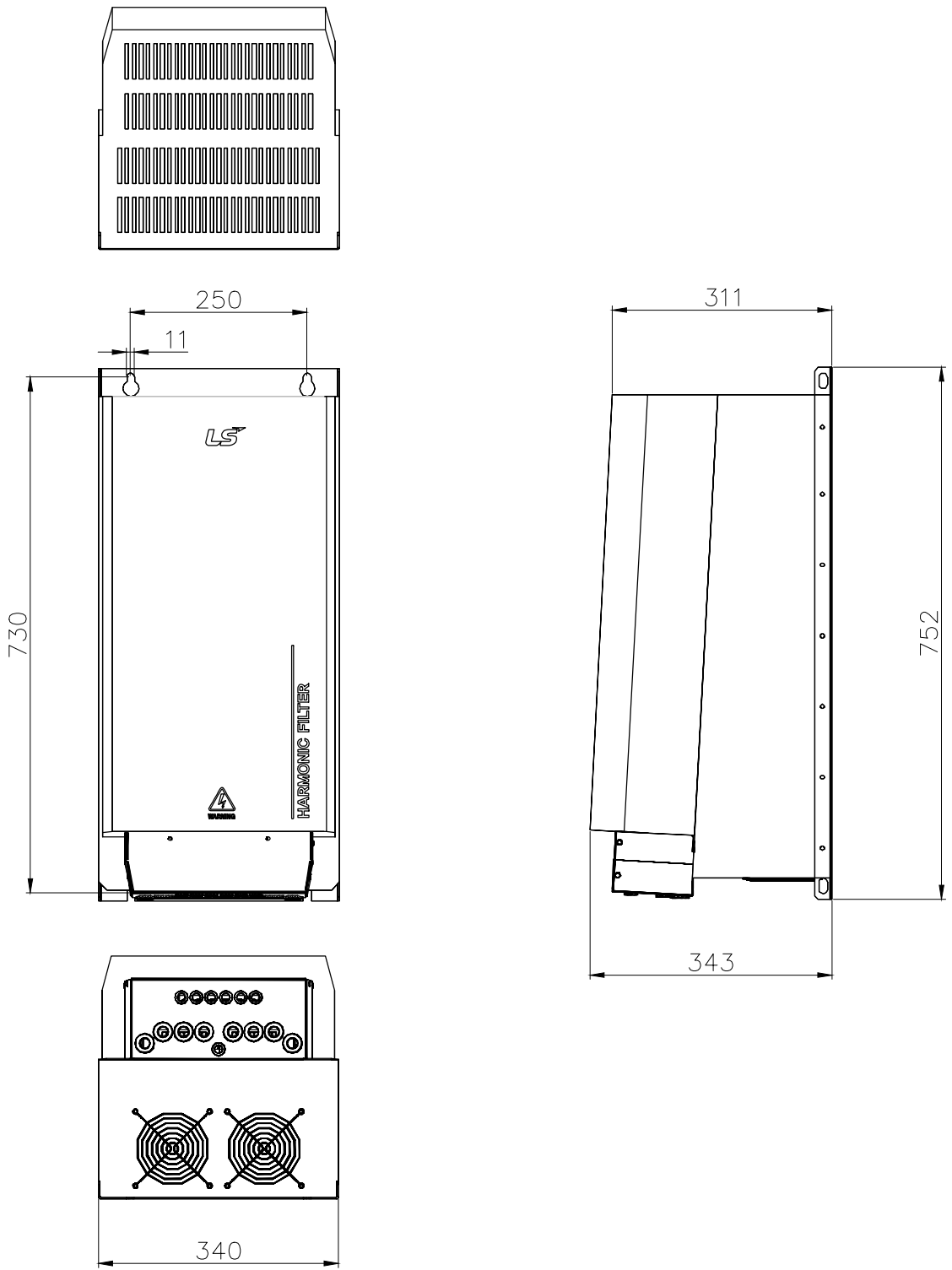

| 적용 제품 Applied Model | |
|------------------------|--|
| HFS-0103-5-60 | |
| HFS-0128-5-60 | |
| | |
| | |

정
개
CHANGE

| | | | | | | | |
|----------------------------------|-----------------|------------------|-----------------|------------------------|------------------------------------------------|---------------|--|
| LS ELECTRIC | | | | HARMONIC FILTER Series | | 매 수 SHEETS | |
| 삼 각 법 3RD ANGLE PROJECTION | 척 도 SCALE | 단 위 DIMENSION | 작 성 일 DATE | 도 면 명 칭 TITLE | HFS EXTERNAL DIMENSION DRAWING FRAME SIZE F | 1 1 | |
| 제 도 DRAWN | 설 계 DESIGNED | 검 도 CHECKED | 승 인 APPROVED | 도 면 번 호 DWG. NO. | | | |
| | | | | 관 련 도 번 REF. NO. | | | |

F
E
D
C
B
A

1 2 3 4 5 6 7 8

| 소요 수 | QTY | 품번 | 품명 | 재질 | 규격 및 도번 | 비고 |
|------|-----|------|-------------|----------|---------------|--------|
| | | ITEM | DESCRIPTION | MATERIAL | SPECIFICATION | REMARK |
| | | | | | | |

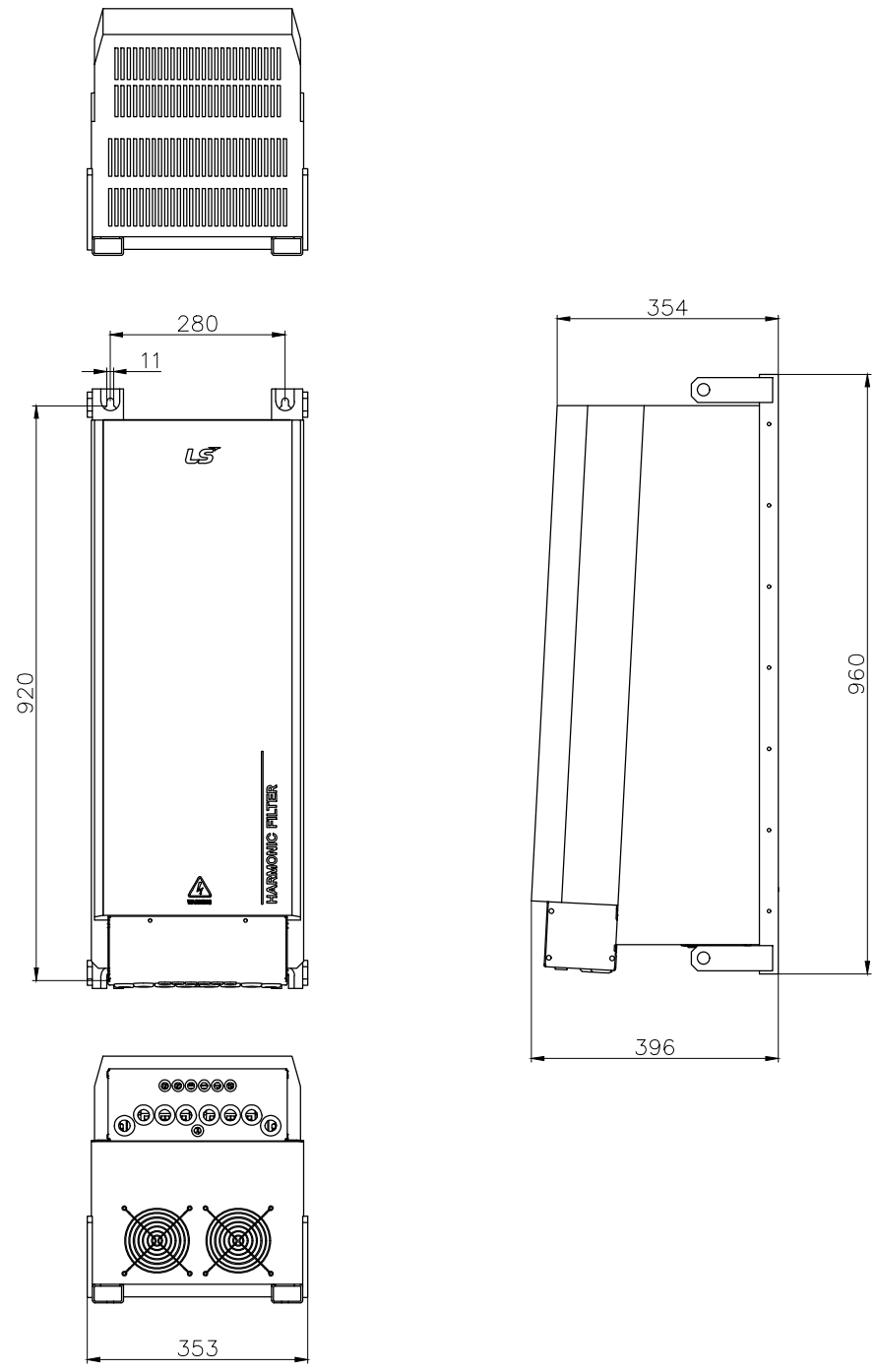

| 적용 제품 Applied Model | |
|------------------------|--|
| HFS-0165-5-60 | |
| HFS-0208-5-60 | |
| HFS-0150-3-50 | |
| HFS-0180-3-50 | |

정
개
CHANGE

| | | | | | | |
|----------------------------------|-----------------|------------------|-----------------|------------------------|------------------------------------------------|---------------|
| LS ELECTRIC | | | | HARMONIC FILTER Series | | 매 수 SHEETS |
| 삼 각 법 3RD ANGLE PROJECTION | 척 도 SCALE | 단 위 DIMENSION | 작 성 일 DATE | 도 면 명 칭 TITLE | HFS EXTERNAL DIMENSION DRAWING FRAME SIZE G | 1 1 |
| 제 도 DRAWN | 설 계 DESIGNED | 검 도 CHECKED | 승 인 APPROVED | 도 면 번 호 DWG. NO. | | |
| | | | | 관 련 도 번 REF. NO. | | |

F
E
D
C
B
A

1 2 3 4 5 6 7 8

| 소요 수 | QTY | 품번 | 품명 | 재질 | 규격 및 도번 | 비고 |
|------|-----|------|-------------|----------|---------------|--------|
| | | ITEM | DESCRIPTION | MATERIAL | SPECIFICATION | REMARK |
| | | | | | | |

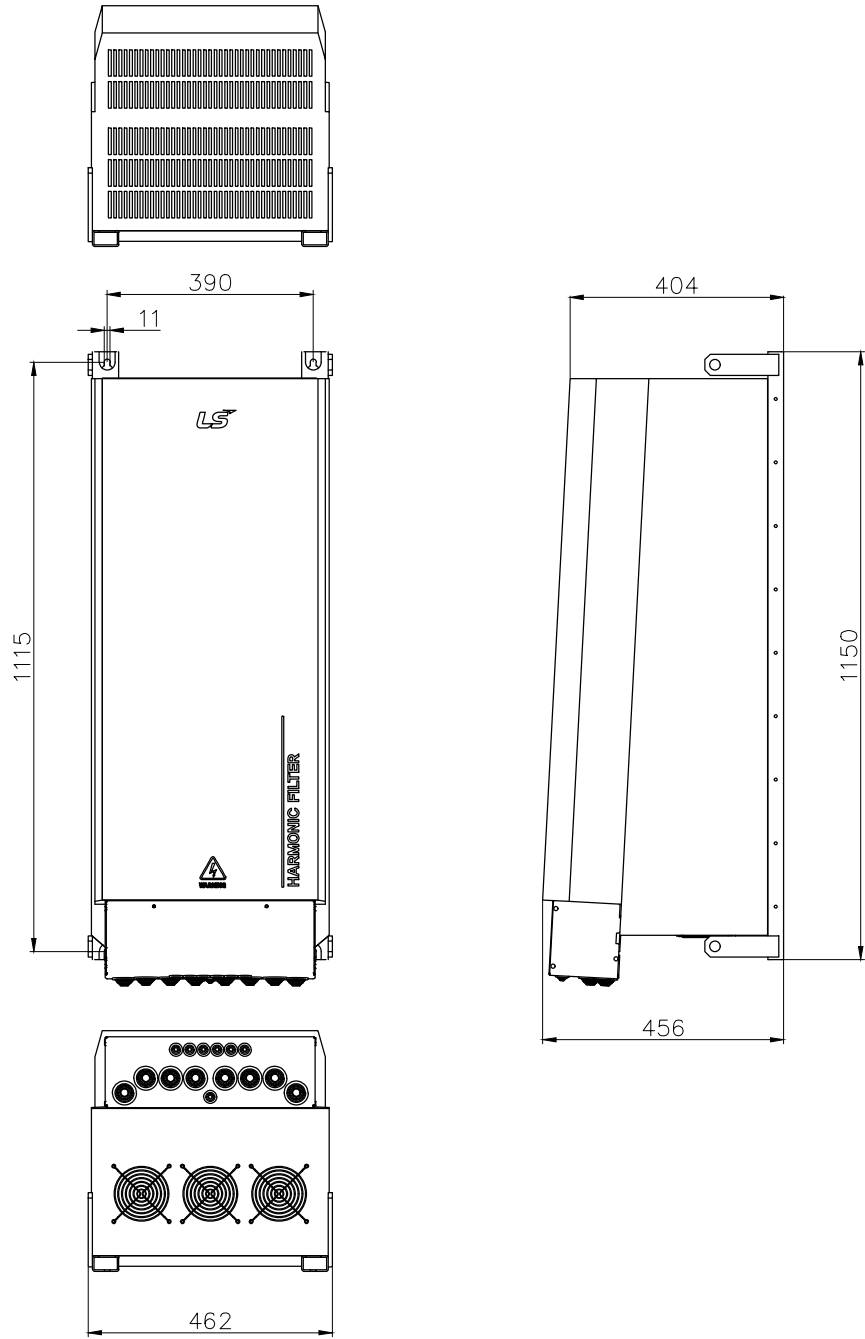

| 적용 제품 Applied Model | |
|------------------------|---------------|
| HFS-0240-5-60 | HFS-0320-3-50 |
| HFS-0320-5-60 | HFS-0400-3-50 |
| HFS-0403-5-60 | |
| HFS-0210-3-50 | |
| HFS-0260-3-50 | |

정
개
CHANGE

| LS ELECTRIC | | | | HARMONIC FILTER Series | | 매 수 |
|----------------------|----------|-----------|------------|--------------------------------|--------------|--------|
| 3RD ANGLE PROJECTION | SCALE | DIMENSION | DATE | 도면명칭 | TITLE | SHEETS |
| 제 | / 1/5 | MM | 2021.02.08 | HFS EXTERNAL DIMENSION DRAWING | FRAME SIZE H | 1/1 |
| 도 | 설 | 계 | 검 | 도 | 승 | 인 |
| DRAWN | DESIGNED | CHECKED | APPROVED | 도면번호 | DWG. NO. | |
| | | | | 관련도번 | REF. NO. | |

F
E
D
C
B
A

1 2 3 4 5 6 7 8

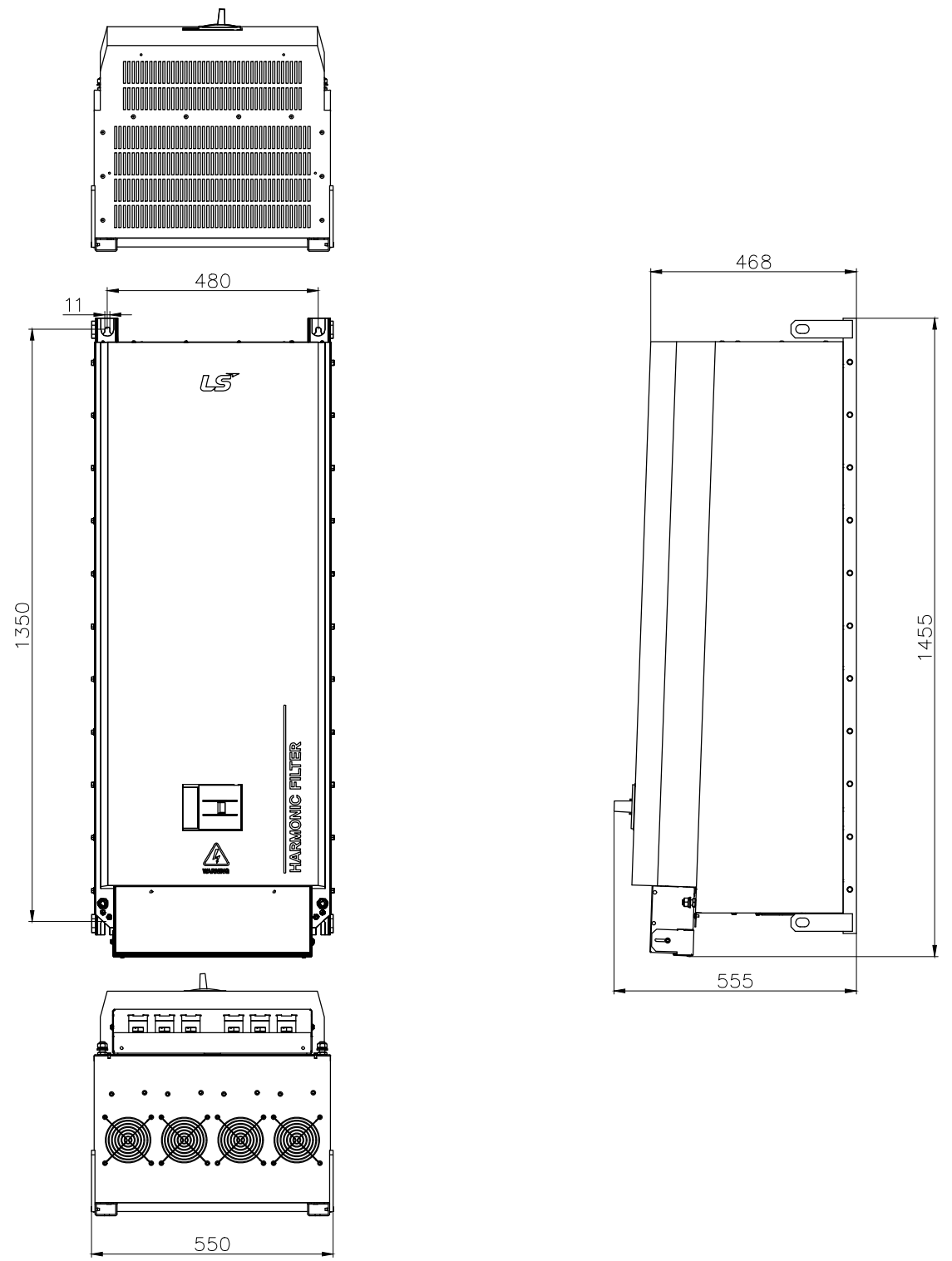

| 소요 수 | QTY | 품번 | 품명 | 재질 | 규격 및 도번 | 비고 |
|------|-----|------|-------------|----------|---------------|--------|
| | | ITEM | DESCRIPTION | MATERIAL | SPECIFICATION | REMARK |
| | | | | | | |

| 적용 제품 Applied Model | |
|------------------------|--|
| HFS-0530-3-50 | |
| | |
| | |
| | |

정
개
CHANGE

| | | | | | | | |
|--------------------------------|---------------|-----------------|---------------|------------------------|------------------------------------------------|---------------|--|
| LS ELECTRIC | | | | HARMONIC FILTER Series | | 매 수 SHEETS | |
| 삼각법 3RD ANGLE PROJECTION | 척도 SCALE | 단위 DIMENSION | 작성 DATE | 도면명칭 TITLE | HFS EXTERNAL DIMENSION DRAWING FRAME SIZE J | 1 1 | |
| 제 DRAWN | 설 DESIGNED | 계 CHECKED | 도 APPROVED | 도면번호 DWG. NO. | | | |
| | | | | 관련도번 REF. NO. | | | |